

SECTION **SB**
SEAT BELTS

A
B
C
D
E
F
G
SB
I
J
K
L
M

CONTENTS

PRECAUTIONS	2	INSTALLATION	6
Precautions for Supplemental Restraint System (SRS) "AIR BAG" and "SEAT BELT PRE-TENSIONER"	2	Seat Belt Inspection	7
Precautions for Seat Belt Service	2	AFTER A COLLISION	7
AFTER A COLLISION	2	PRELIMINARY CHECKS	7
Precautions for Battery Service	3	SEAT BELT RETRACTOR ON-VEHICLE CHECK	8
SEAT BELTS	4	SEAT BELT RETRACTOR OFF-VEHICLE CHECK	9
System Description	4	LATCH (LOWER ANCHORS AND TETHER FOR CHILDREN) SYSTEM	10
SEAT BELT WARNING CHIME	4	Removal and Installation	10
SEAT BELT WARNING LAMP	4	REMOVAL	10
Removal and Installation of Front Seat Belt	4	INSTALLATION	10
REMOVAL OF SEAT BELT RETRACTOR	4	TOP TETHER STRAP CHILD RESTRAINT	11
INSTALLATION OF SEAT BELT RETRACTOR.....	5	Removal and Installation	11
REMOVAL OF SEAT BELT BUCKLE	5	REMOVAL	11
INSTALLATION OF SEAT BELT BUCKLE	5	INSTALLATION	11
Removal and Installation of Rear Seat Belt	6		
REMOVAL	6		

PRECAUTIONS

PRECAUTIONS

PF0:00001

Precautions for Supplemental Restraint System (SRS) “AIR BAG” and “SEAT BELT PRE-TENSIONER”

AHS000DH

The Supplemental Restraint System such as “AIR BAG” and “SEAT BELT PRE-TENSIONER”, used along with a front seat belt, helps to reduce the risk or severity of injury to the driver and front passenger for certain types of collision. This system includes seat belt switch inputs and dual stage front air bag modules. The SRS system uses the seat belt switches to determine the front air bag deployment, and may only deploy one front air bag, depending on the severity of a collision and whether the front occupants are belted or unbelted. Information necessary to service the system safely is included in the SRS and SB section of this Service Manual.

WARNING:

- To avoid rendering the SRS inoperative, which could increase the risk of personal injury or death in the event of a collision which would result in air bag inflation, all maintenance must be performed by an authorized NISSAN/INFINITI dealer.
- Improper maintenance, including incorrect removal and installation of the SRS, can lead to personal injury caused by unintentional activation of the system. For removal of Spiral Cable and Air Bag Module, see the SRS section.
- Do not use electrical test equipment on any circuit related to the SRS unless instructed to in this Service Manual. SRS wiring harnesses can be identified by yellow and/or orange harnesses or harness connectors.

Precautions for Seat Belt Service

AHS000DI

CAUTION:

- Before removing the front seat belt pre-tensioner assembly, turn the ignition switch off, disconnect the both battery cables and wait at least 3 minutes.
- Do not use electrical test equipment for front seat belt pre-tensioner connector.
- After replacing or reinstalling front seat belt pre-tensioner assembly, or reconnecting front seat belt pre-tensioner connector, check the system function. Refer to [SRS-18, "SRS Operation Check"](#).
- Deploy front seat belt pre-tensioner assembly before disposing. Refer to [SRS-51, "DISPOSAL OF AIR BAG MODULE AND SEAT BELT PRE-TENSIONER"](#).
- Do not use disassemble buckle or seat belt assembly.
- Replace anchor bolts if they are deformed or worn out.
- Never oil tongue and buckle.
- If any component of seat belt assembly is questionable, do not repair. Replace the whole seat belt assembly.
- If webbing is cut, frayed, or damaged, replace seat belt assembly.
- When replacing seat belt assembly, use a genuine NISSAN seat belt assembly.

AFTER A COLLISION

WARNING:

Inspect all seat belt assemblies including retractors and attaching hardware after any collision. NISSAN recommends that all seat belt assemblies in use during a collision be replaced unless the collision was minor and the belts show no damage and continue to operate properly. Failure to do so could result in serious personal injury in an accident. Seat belt assemblies not in use during a collision should also be replaced if either damage or improper operation is noted. Seat belt pre-tensioner should be replaced even if the seat belts are not in use during a frontal collision in which the air bags are deployed.

Replace any seat belt assembly (including anchor bolts) if:

- The seat belt was in use at the time of a collision (except for minor collisions and the belts, retractors and buckles show no damage and continue to operate properly).
- The seat belt was damaged in an accident. (i.e. torn webbing, bent retractor or guide).
- The seat belt attaching point was damaged in an accident. Inspect the seat belt attaching area for damage or distortion and repair as necessary before installing a new seat belt assembly.
- Anchor bolts are deformed or worn out.

PRECAUTIONS

- The front seat belt pre-tensioner should be replaced even if the seat belts are not in use during the collision in which the air bags are deployed.

Precautions for Battery Service

AHS000EZ

Before disconnecting the battery, lower both the driver and passenger windows. This will prevent any interference between the window edge and the vehicle when the door is opened/closed. During normal operation, the window slightly raises and lowers automatically to prevent any window to vehicle interference. The automatic window function will not work with the battery disconnected.

A
B
C
D
E
F
G
SB
I
J
K
L
M

SB

SEAT BELTS

PFP:86884

SEAT BELTS

System Description

SEAT BELT WARNING CHIME

AHS000DJ

- With ignition switch turned ON and seat belt unfastened (seat belt switch ON), warning chime will sound for approximately 6 seconds.
- If warning chime does not sound, refer to [DI-54, "Seat Belt Warning Chime Does Not Operate"](#).

SEAT BELT WARNING LAMP

- Fasten driver's seat belt.
- The seat belt warning lamp should go out.
- If the seat belt warning lamp does not go out, refer to [DI-28, "Wiring Diagram — WARN —"](#).

Removal and Installation of Front Seat Belt

AHS000DK

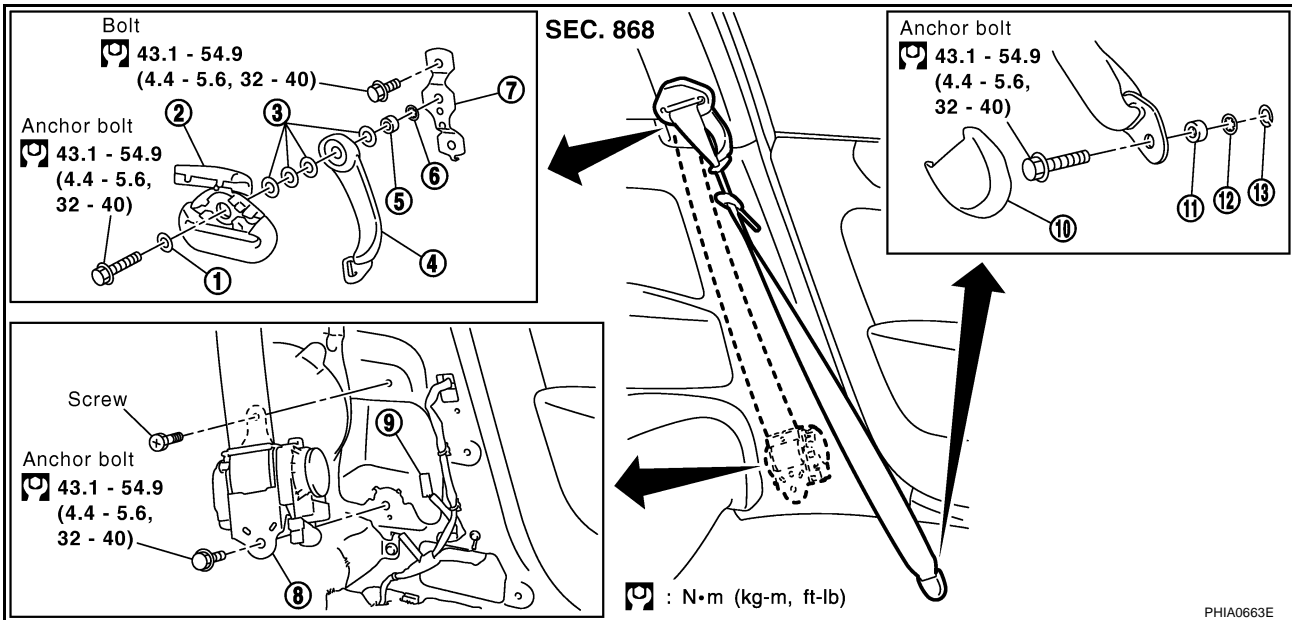

- | | | |
|------------------------|----------------------------|--------------------------------------|
| 1. Plastic washer | 2. Through-anchor assembly | 3. Spacer |
| 4. Seat belt extension | 5. Spacer | 6. Retaining washer |
| 7. Seat belt bracket | 8. Retractor | 9. Seat belt pre-tensioner connector |
| 10. Outer anchor cover | 11. Spacer | 12. Spring washer |
| 13. Fiber washer | | |

CAUTION:

Before servicing SRS, turn the ignition switch off, disconnect both battery cables and wait at least 3 minutes.

REMOVAL OF SEAT BELT RETRACTOR

1. Open the cover of through-anchor assembly.
2. Remove the anchor bolt.
3. Remove the outer anchor cover, and remove the anchor bolt.
4. Remove the rear pillar garnish and rear side finisher. Refer to [EI-32, "Removal and Installation"](#).
5. Disconnect the front seat belt pre-tensioner connector.

SEAT BELTS

CAUTION:

- For installing/removing pre-tensioner seat belt connector, insert thin screwdriver wrapped in tape into notch, lift lock and remove connector.
- Install connector with lock raised, and push lock into connector.

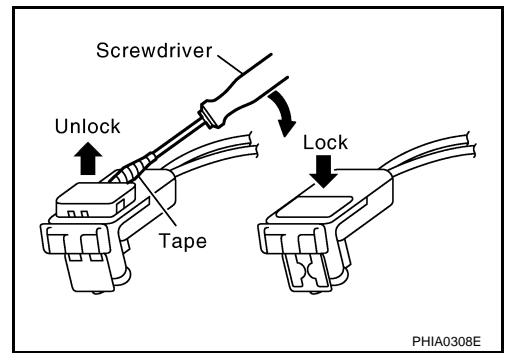

6. Remove the front seat belt pre-tensioner retractor fixing screw and anchor bolt, and then remove the seat belt retractor.

INSTALLATION OF SEAT BELT RETRACTOR

CAUTION:

Before servicing SRS, turn the ignition switch off, disconnect both battery cables and wait at least 3 minutes.

Install in the reverse order of removal.

REMOVAL OF SEAT BELT BUCKLE

1. Remove the front seat. Refer to [SE-55, "REMOVAL"](#).
2. Disconnect seat belt buckle connector.
3. Remove the anchor bolt, and remove the seat belt buckle.

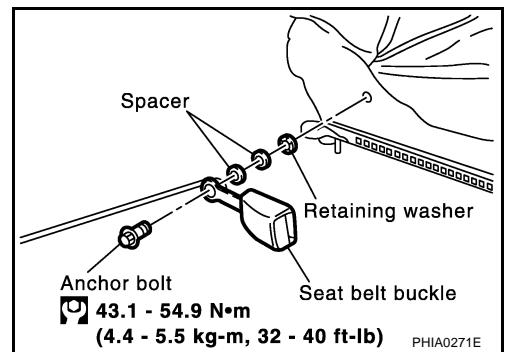

INSTALLATION OF SEAT BELT BUCKLE

Install in the reverse order of removal.

SEAT BELTS

AHS000DL

Removal and Installation of Rear Seat Belt

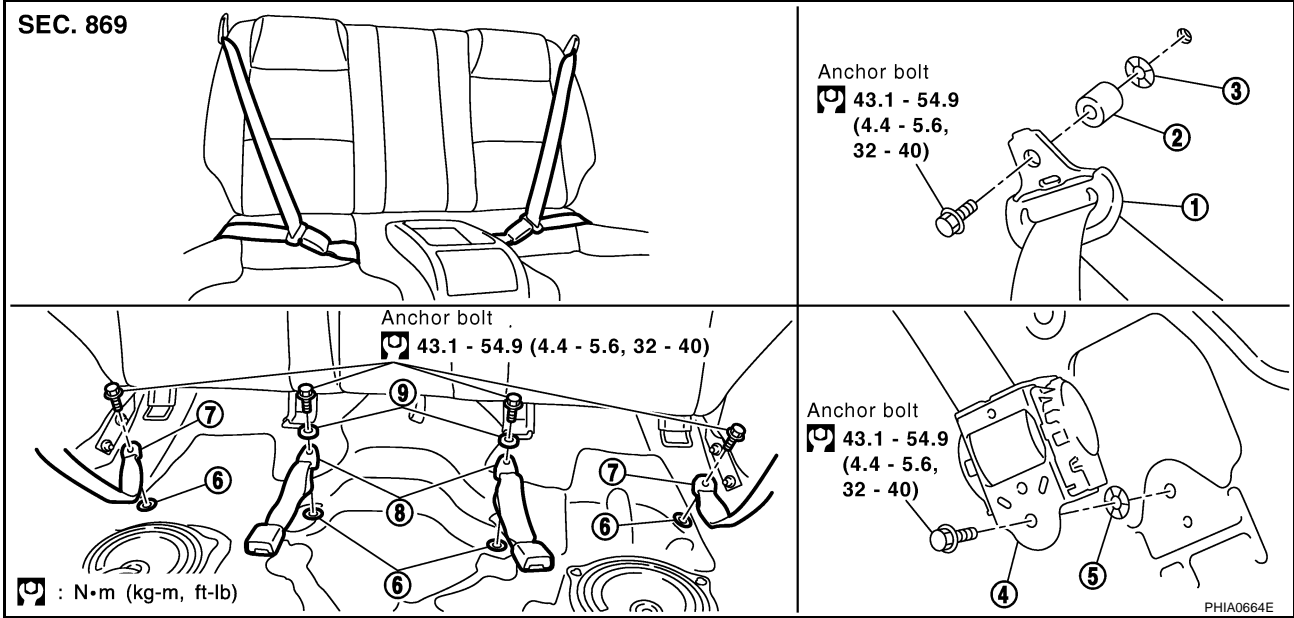

- | | | |
|-------------------|-----------------|-----------------|
| 1. Through-anchor | 2. Spacer | 3. Fiber washer |
| 4. Retractor | 5. Fiber washer | 6. Fiber washer |
| 7. Outer anchor | 8. Inner anchor | 9. Spacer |

REMOVAL

1. Remove the rear seat cushion. Refer to [SE-59, "Removal and Installation"](#) .
2. Remove the rear pillar garnish and rear side finisher. Refer to [EI-32, "Removal and Installation"](#) .
3. Remove the outer anchor and floor anchor bolt.
4. Remove side curtain air bag module fixing bolts. Refer to [SRS-45, "Removal and Installation"](#) .
5. Remove seat belt retractor mounting screw and anchor bolt, and remove the seat belt assembly.

INSTALLATION

Install in the reverse order of removal.

SEAT BELTS

AHS000DM

Seat Belt Inspection AFTER A COLLISION

WARNING:

Inspect all seat belt assemblies including retractors and attaching hardware after any collision. NISSAN recommends that all seat belt assemblies in use during a collision be replaced unless the collision was minor and the belts show no damage and continue to operate properly. Failure to do so could result in serious personal injury in an accident. Seat belt assemblies not in use during a collision should also be replaced if either damage or improper operation is noted. Seat belt pre-tensioners should be replaced even if the seat belts are not in use during a frontal collision in which the air bags are deployed.

Replace any seat belt assembly (including anchor bolts) if:

- The seat belt was in use at the time of a collision (except for minor collisions and the belts, retractors and buckles show no damage and continue to operate properly).
- The seat belt was damaged in an accident. (i.e. torn webbing, bent retractor or guide).
- The seat belt attaching point was damaged in an accident. Inspect the seat belt attaching area for damage or distortion and repair as necessary before installing a new seat belt assembly.
- Anchor bolts are deformed or worn out.
- The front seat belt pre-tensioner should be replaced even if the seat belts are not in use during the collision in which the air bags are deployed.

PRELIMINARY CHECKS

1. Check the seat belt warning lamp/chime for proper operation as follows:
 - a. Turn ignition switch ON. The seat belt warning lamp should illuminate. Also, the seat belt warning chime should sound for about six seconds.
 - b. Fasten driver's seat belt. The seat belt warning lamp should go out and the chime (if sounding) should stop.
2. If the air bag warning lamp is blinking, conduct self-diagnosis using CONSULT-II, and air bag warning lamp. Refer to [SRS-18, "SRS Operation Check"](#).
3. Make sure the seat belt retractor, seat belt anchor and buckle bolts are securely attached.
4. Check the shoulder seat belt guide and shoulder belt height adjuster for front seats. Ensure that guide swivels freely and that webbing lays flat and does not bind in guide. Ensure height adjuster operates properly and holds securely.
5. Check retractor operation:
 - a. Fully extend the seat belt webbing and check for twists, tears or other damage.
 - b. Allow the seat belt to retract. Ensure that webbing returns smoothly and completely into the retractor. If the seat belt does not return smoothly, wipe the inside of the loops with a clean paper cloth, because dirt built up in the loops of the upper anchors can cause the seat belts to retract slowly.
 - c. Fasten the seat belt. Make sure the seat belt returns smoothly and completely to the retractor. If the webbing does not return smoothly, the cause may be an accumulation of dust or dirt. Use the "SEAT BELT TAPE SET" and perform the following steps.

Inspect the front seat belt through-anchor:

1. Pull the seat belt out to a length of 500 mm (19.69 in) or more.
2. Use a clip or other device to fix the seat belt at the center pillar webbing opening.
3. Pass a thin wire through the through-anchor webbing opening. Hold both ends of the wire and pull taut while moving it up and down several times along the webbing opening surface to remove dirt.
4. Any dirt that cannot be removed with the wire can be removed by cleaning the opening with a clean cloth.
5. Apply tape at the point where the webbing contacts the through-anchor webbing opening.

NOTE:

- Apply the tape so that there is no looseness or wrinkling.
6. Remove the clip fixing the seat belt and make sure that the webbing returns smoothly.
7. Repeat steps above as necessary to check the other seat belts.

SEAT BELTS

SEAT BELT RETRACTOR ON-VEHICLE CHECK

Emergency Locking Retractors (ELR) and Automatic Locking Retractors (ALR)

NOTE:

All seat belt retractors are of the Emergency Locking Retractors (ELR) type. In an emergency (sudden stop) the retractor will lock and prevent the webbing from extending any further. All 3-point type seat belt retractors except the driver's seat belt also have an Automatic Locking Retractors (ALR) mode. The ALR mode (also called child restraint mode) is used when installing child seats. The ALR mode is activated when the seat belt is fully extended. When the webbing is then retracted partially, the ALR mode automatically locks the seat belt in a specific position so the webbing cannot be extended any further. To cancel the ALR mode, allow the seat belt to fully wind back into the retractor.

Check the seat belt retractors using the following test(s) to determine if a retractor assembly is operating properly.

ELR Function Stationary Check

Grasp the shoulder webbing and pull forward quickly. The retractor should lock and prevent the belt from extending further.

ALR Function Stationary Check

1. Pull out entire length of seat belt from retractor until a click is heard.
2. Retract the webbing partially. A clicking noise should be heard as the webbing retracts indicating that the retractor is in the Automatic Locking Retractor (ALR) mode.
3. Grasp the seat belt and try to pull out the retractor. The webbing must lock and not extend any further. If necessary replace the retractor assembly.
4. Allow the entire length of the webbing to retract to cancel the automatic locking mode.

ELR Function Moving Check

WARNING:

Perform the following test in a safe, open area clear of other vehicles and obstructions (for example, a large, empty parking lot). Road surface must be paved and dry. DO NOT perform the following test on wet or gravel roads or on public streets and highways. This could result in an accident and serious personal injury. The driver and passenger must be prepared to brace themselves in the event the retractor does not lock.

1. Fasten driver's seat belt. Buckle a passenger into the seat for the belt that is to be tested.
2. Proceed to the designated safe area.
3. Drive the vehicle at approximately 16 km/h (10 MPH). Notify any passengers of a pending sudden stop. The driver and passenger must be prepared to brace themselves in the event the retractor does not lock. Apply brakes firmly and make a very hard stop.

During stop, seat belts should lock and not be extended. If the seat belt retractor assembly does not lock, perform the retractor off-vehicle check.

SEAT BELTS

SEAT BELT RETRACTOR OFF-VEHICLE CHECK

1. Remove the seat belt retractor assembly.
2. Slowly pull out webbing while tilting the retractor assembly forward from the mounted position without twisting the retractor assembly as shown in the illustration.

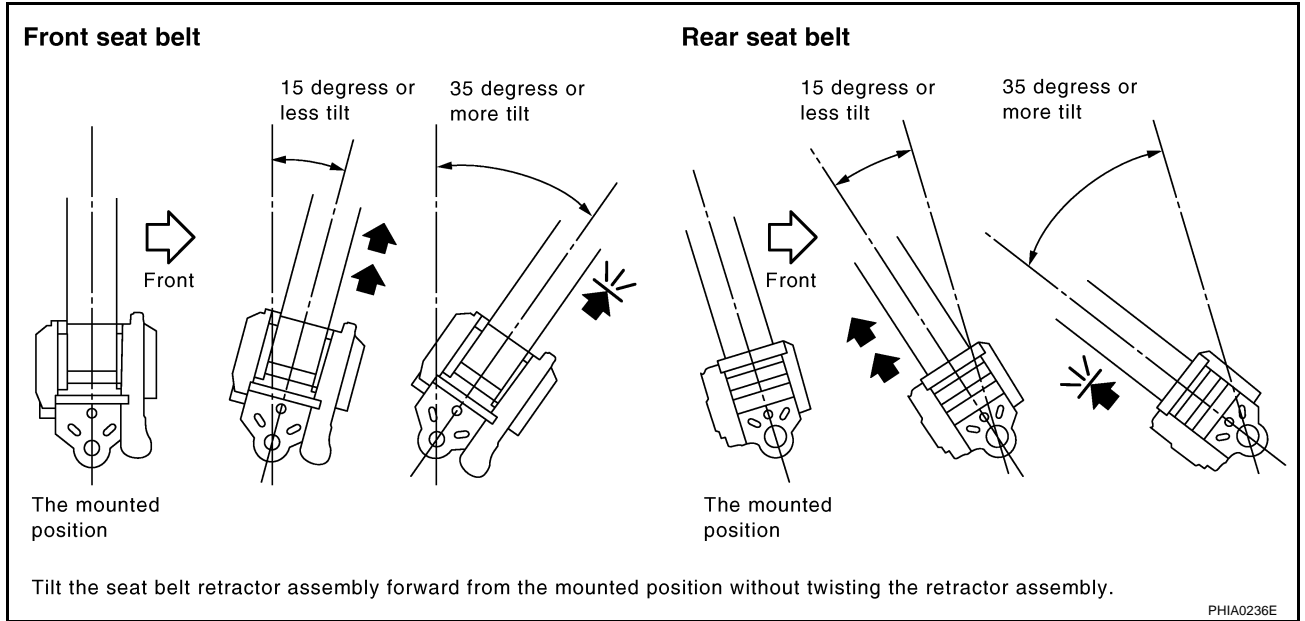

15 degrees or less tilt : Webbing can be pulled out.

35 degrees or more tilt : Webbing locks and cannot be pulled out.

If NG, replace the retractor assembly.

A
B
C
D
E
F
G
SB
I
J
K
L
M

LATCH (LOWER ANCHORS AND TETHER FOR CHILDREN) SYSTEM

LATCH (LOWER ANCHORS AND TETHER FOR CHILDREN) SYSTEM

PFP:75466

Removal and Installation

AHS000DN

CAUTION:

Replace anchor bolts if they are deformed or worn out.

REMOVAL

1. Remove the rear seat cushion. Refer to [SE-59, "Removal and Installation"](#) .
2. Remove LATCH (Lower Anchors and Tether for Children) system.

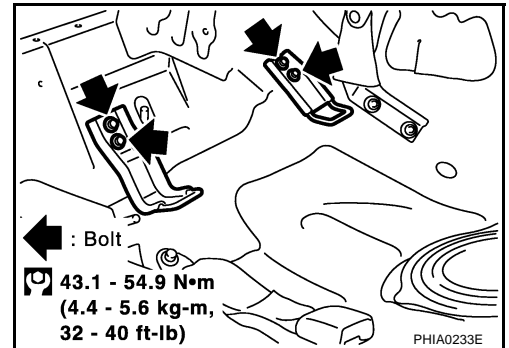

INSTALLATION

Install in the reverse order of removal.

TOP TETHER STRAP CHILD RESTRAINT

TOP TETHER STRAP CHILD RESTRAINT

PFP:88000

Removal and Installation

AHS000DO

CAUTION:

Replace anchor bolts if they are deformed or worn out.

REMOVAL

1. Remove the top tether strap child restraint cover. Refer to [EI-34, "Removal and Installation"](#).
2. Remove the top tether strap child restraint.

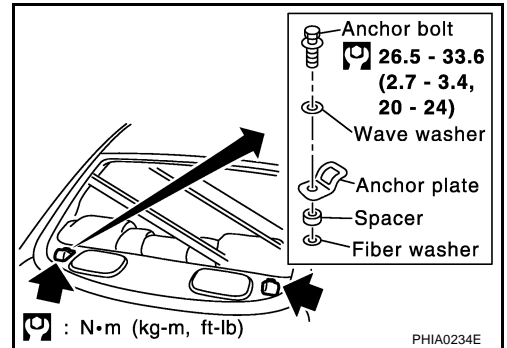

INSTALLATION

Install in the reverse order of removal.

A
B
C
D
E
F
G
SB
I
J
K
L
M

TOP TETHER STRAP CHILD RESTRAINT
