

ACCELERATOR CONTROL, FUEL & EXHAUST SYSTEMS

SECTION FE

GI

MA

EM

LC

EC

FE

AT

AX

SU

BR

ST

RS

BT

HA

SC

EL

IDX

CONTENTS

PREPARATION	2	REMOVAL.....	6
Special Service Tool	2	INSTALLATION.....	6
Commercial Service Tools	2	Fuel Pump, Fuel Level Sensor Unit and Fuel	
ACCELERATOR CONTROL SYSTEM	3	Filter	7
Removal and Installation	3	REMOVAL.....	7
Adjusting Accelerator Wire	3	INSTALLATION.....	10
FUEL SYSTEM	5	EXHAUST SYSTEM	11
Removal and Installation	5	Removal and Installation	11
Fuel Tank	6		

PREPARATION

Special Service Tool

Special Service Tool

NHFE0001

The actual shapes of Kent-Moore tools may differ from those of special service tools illustrated here.

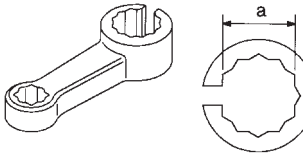
Tool number (Kent-Moore No.) Tool name	Description	
KV10114400 (J-38365) Heated oxygen sensor wrench		Loosening or tightening front and rear heated oxygen sensors a: 22 mm (0.87 in)
NT636		

Commercial Service Tools

NHFE0008

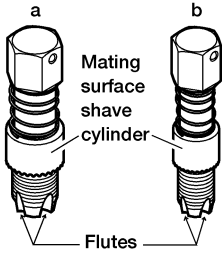
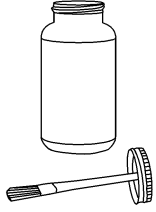
Tool number (Kent-Moore No.) Tool name	Description	
(J-43897-18) (J-43897-12) Oxygen sensor thread cleaner		Reconditioning the exhaust system threads before installing a new oxygen sensor (Use with anti-seize lubricant shown below.) a: J-43897-18 (18 mm dia.) for zirconia oxygen sensor b: J-43897-12 (12 mm dia.) for titania oxygen sensor
AEM488		
Anti-seize lubricant (Permatex 133AR or equivalent meeting MIL specification MIL-A-907)		Lubricating oxygen sensor thread cleaning tool when reconditioning exhaust system threads
AEM489		

Removal and Installation

NHFE0002

CAUTION:

- When removing accelerator wire, make a mark to indicate lock nut's initial position.
- Check that throttle valve opens fully when accelerator pedal is fully depressed. Also check that it returns to idle position when pedal is released.
- Check accelerator control parts for improper contact with any adjacent parts.
- When connecting accelerator wire, be careful not to twist or scratch wire.

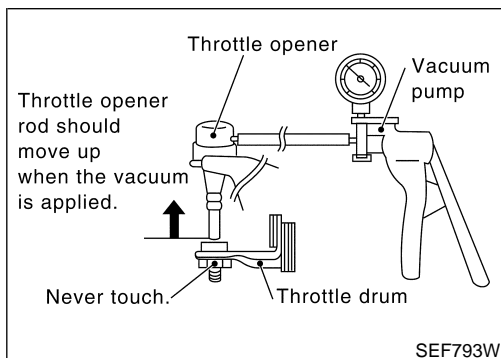
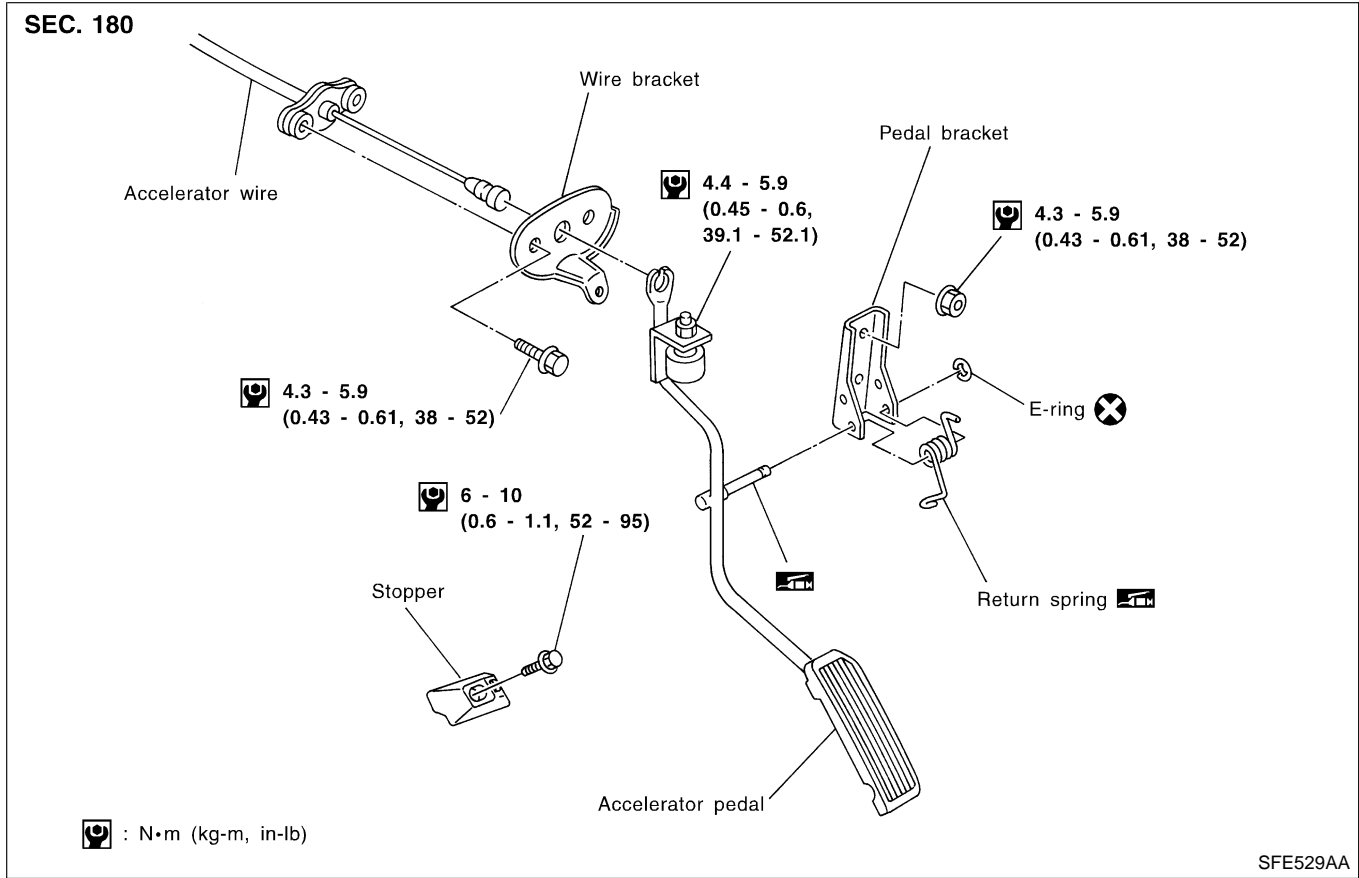

Adjusting Accelerator Wire

NHFE0003

CAUTION:

- Make sure the ASCD wire is not pulling the throttle drum.
- For ASCD wire adjustment, refer to EL-293, "AUTOMATIC SPEED CONTROL DEVICE (ASCD)".

1. Remove the vacuum hose connected to the throttle opener.
2. Connect suitable vacuum hose to vacuum pump as shown left.
3. Apply vacuum [more than -40.0 kPa (-300 mmHg, -11.81 inHg)] until the throttle drum becomes free from the rod of the throttle opener.

Make sure that there is clearance between the throttle

GI
MA
EM
LC
EC
FE
AT
AX
SU
BR
ST
RS
BT
HA
SC
EL
IDX

ACCELERATOR CONTROL SYSTEM

Adjusting Accelerator Wire (Cont'd)

drum and rod.

If NG, refer to EC-110, "Basic Inspection".

If OK, go to following step.

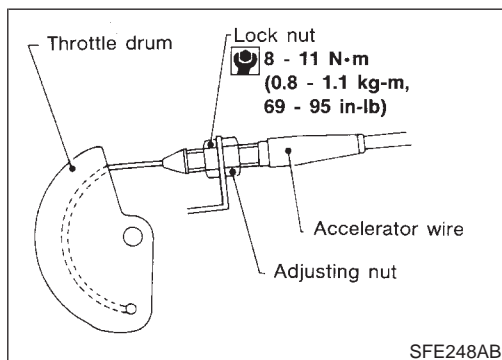

4. Loosen lock nut.
5. Tighten accelerator adjusting nut until throttle drum starts to move.
6. From that position, turn back adjusting nut 1.5 to 2 turns, and secure lock nut.
7. Release vacuum from the throttle opener.
8. Remove vacuum pump and vacuum hose from the throttle opener.
9. Reinstall the original vacuum hose to the throttle opener securely.

Removal and Installation

NHFE0004

WARNING:

When replacing fuel line parts, be sure to observe the following.

- Put a "CAUTION: FLAMMABLE" sign in workshop.
- Be sure to furnish workshop with a CO₂ fire extinguisher.
- Do not smoke while servicing fuel system. Keep open flames and sparks away from work area.

CAUTION:

- Before removing fuel line parts, carry out the following procedures:
 - a) Put drained fuel in an explosion-proof container and put the lid on securely.
 - b) Release fuel pressure from fuel line. Refer to EC-50, "Fuel Pressure Release".
 - c) Disconnect battery ground cable.
- Always replace O-ring and clamps with new ones.
- Do not kink or twist tubes when they are being installed.
- Do not tighten hose clamps excessively to avoid damaging hoses.
- After installing tubes, run engine and check for fuel leaks at connections.
- Use only a genuine NISSAN fuel filler cap as a replacement. If an incorrect fuel filler cap is used, the MIL may come on.
- For inspection, refer to EC-38, "On Board Refueling Vapor Recovery (ORVR)".

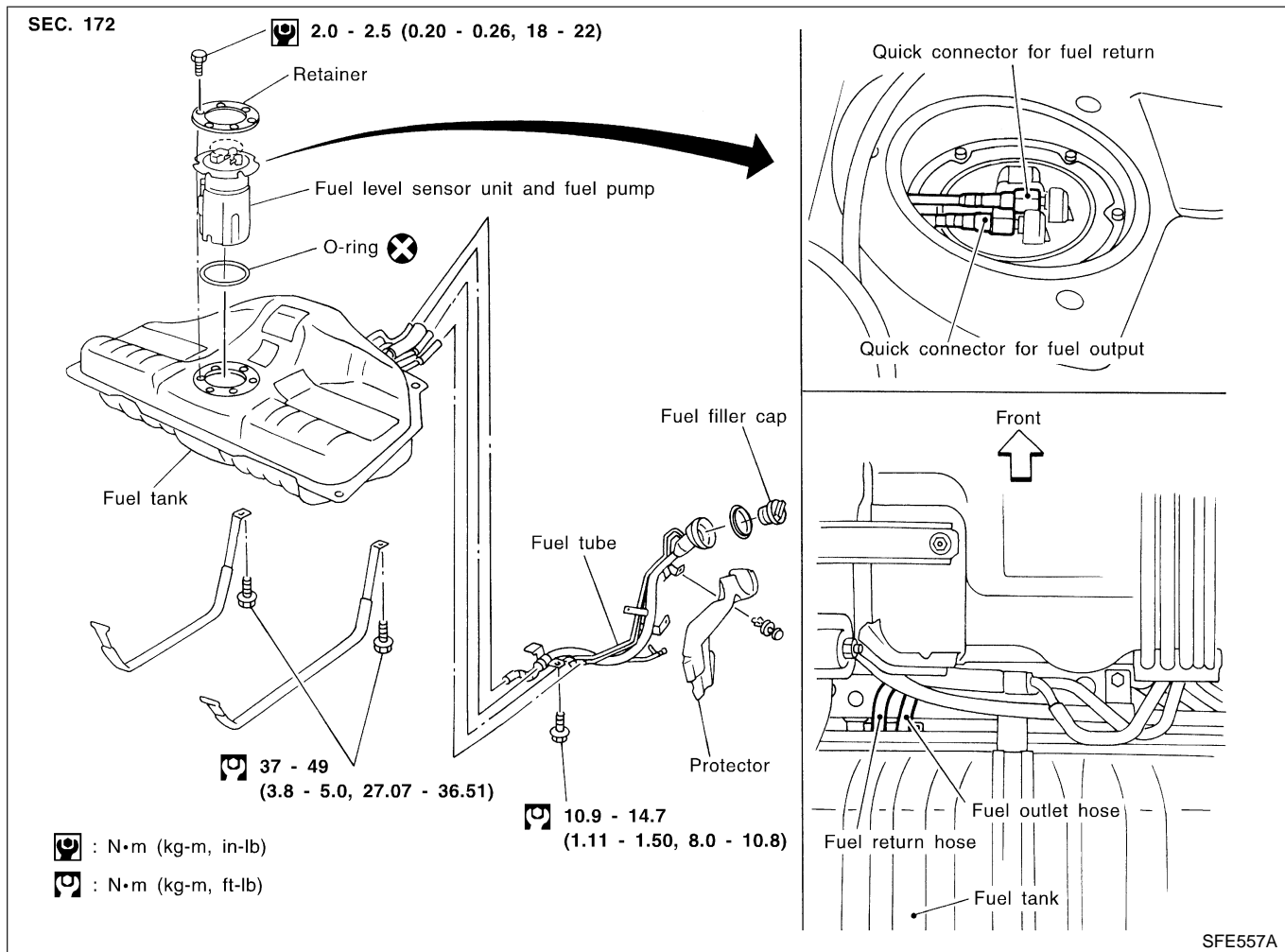

GI

MA

EM

LC

EC

FE

AT

AX

SU

BR

ST

RS

BT

HA

SC

EL

IDX

FUEL SYSTEM

Fuel Tank

NHFE0006

NHFE0006S01

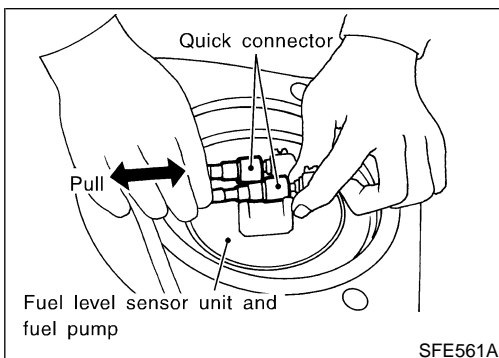
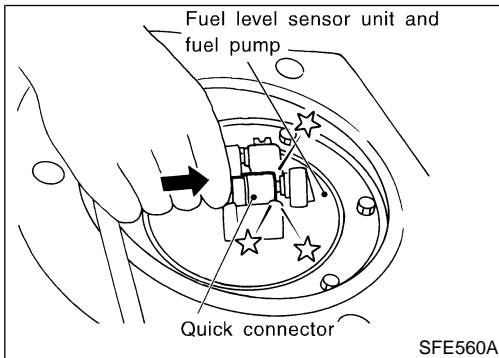
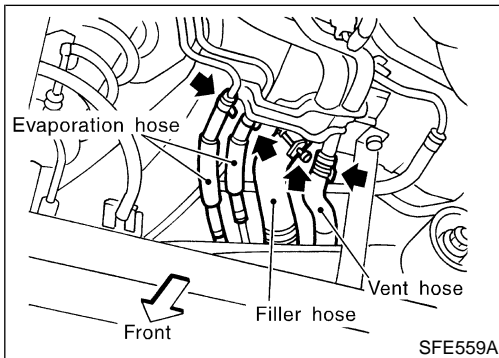
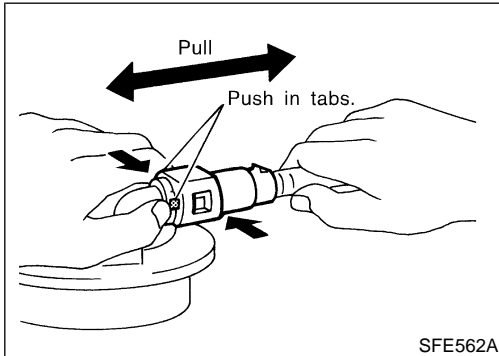
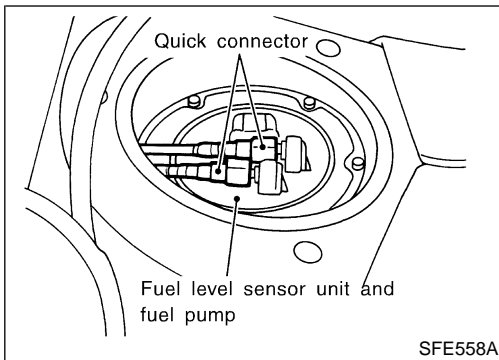

Fuel Tank

REMOVAL

1. Release fuel pressure from fuel line. Refer to EC-50, "Fuel Pressure Release".
2. Disconnect battery ground cable.
3. Drain fuel from fuel tank.
4. Disconnect electrical connector.
5. Remove the quick connector as follows.
 - a. Put mating marks on tubes and connectors for correct installation.
 - b. Hold the sides of the connector, push in tabs, and pull out the tube inserted in the retainer.

CAUTION:

- The tube can be removed when the push in tabs are completely depressed. Do not twist it more than necessary.
- Do not use any tools to remove the quick connector.
- Keep clean the connecting portion of the tube and the quick connector.

6. Disconnect filler hose, vent hose and evaporation hose at fuel tank side.
7. Remove fuel tank mounting band bolts while supporting fuel tank.
8. Remove fuel tank.

INSTALLATION

NHFE0006S02

To install, reverse the removal procedure. Connect the quick connector as follows:

- Align mating marks on tubes and connectors for correct installation.
- Align push in tabs with retainer openings.
- **Be sure that the connecting portion of the tube and the quick connector is clean and smooth.**
- Insert tube into the center of the connector until you hear a click.

After connecting quick connector, make sure the connection is firmly made using the following method.

- Pull on the fuel tube and connector to make sure they are firmly connected.
- Start the engine, increase engine speed and verify that there are no leaks.

FUEL SYSTEM

Fuel Pump, Fuel Level Sensor Unit and Fuel Filter

Fuel Pump, Fuel Level Sensor Unit and Fuel Filter

NHFE0007

SEC. 172 Quick connectors

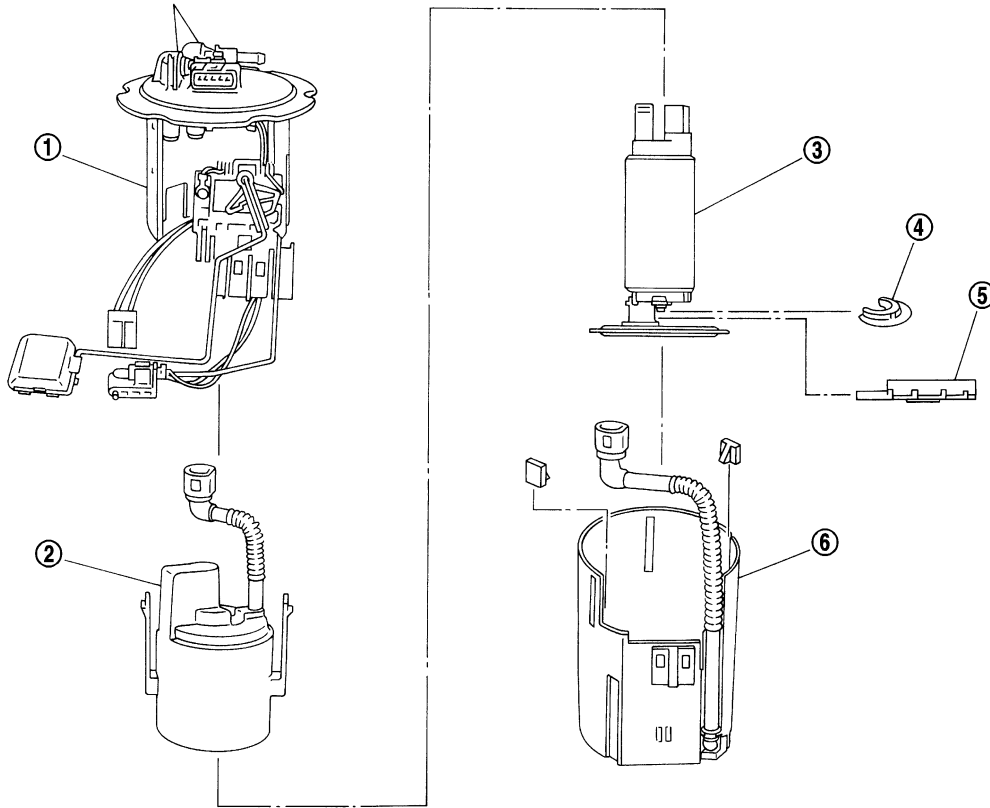

- ① Fuel level sensor unit
- ② Fuel filter
- ③ Fuel pump
- ④ Pump support rubber
- ⑤ Fuel pump bracket
- ⑥ Chamber

SFE565A

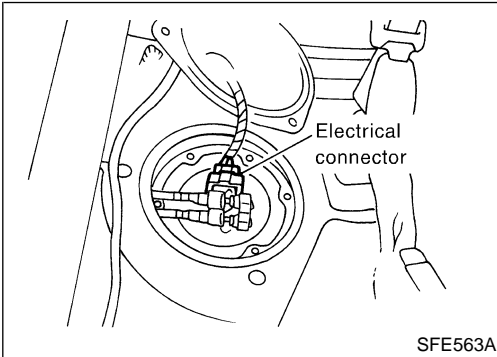

SFE563A

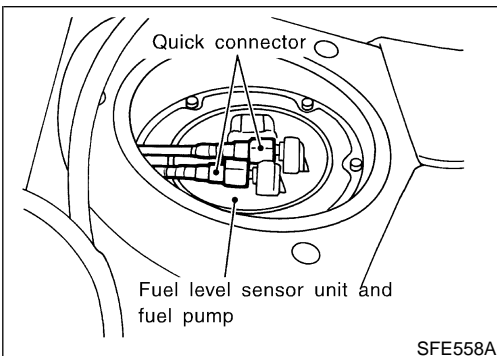

SFE558A

REMOVAL

NHFE0007S01

1. Release fuel pressure from fuel line.
Refer to EC-50, "Fuel Pressure Release".
2. Remove rear seat bottom. Refer to BT-49, "Removal and Installation".
3. Remove inspection hole cover located under the rear seat.
4. Disconnect electrical connector.
5. Remove the quick connectors.
 - For removal of quick connectors, refer to step 5. of "Fuel Tank Removal".
6. Remove the six screws.

GI
MA
EM
LC
EC
FE
AT
AX
SU
BR
ST
RS
BT
HA
SC
EL
IDX

FUEL SYSTEM

Fuel Pump, Fuel Level Sensor Unit and Fuel Filter (Cont'd)

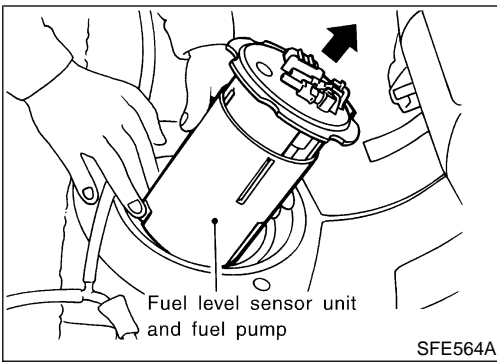

7. Pull out the fuel level sensor unit and fuel pump.
 - Do not damage the arm of the fuel level sensor and fuel tank temperature sensor.

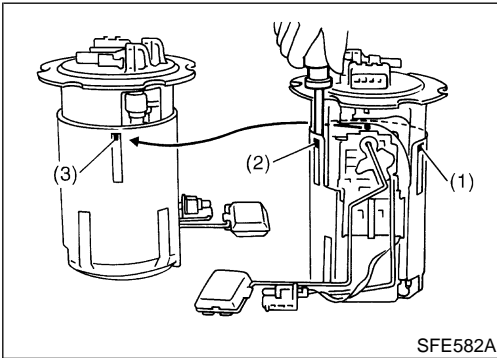

8. Remove flange of fuel level sensor unit and fuel pump.
 - Using a screwdriver, remove the snap fit portion in the order of (1), (2) and (3) as shown in the figure at left.

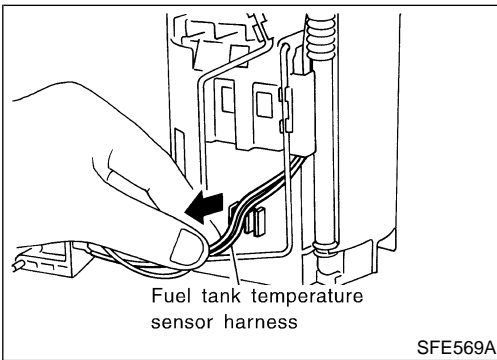

9. Pull out the fuel tank temperature sensor harness.

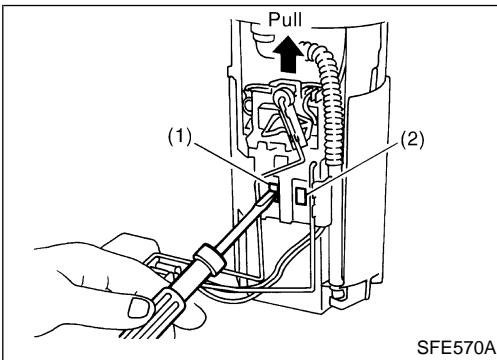

10. Push fuel level sensor flange.
 - Using a screwdriver, remove the snap fit portion in the order of (1) and (2) as shown in the figure at left.
11. Pull up the fuel level sensor.

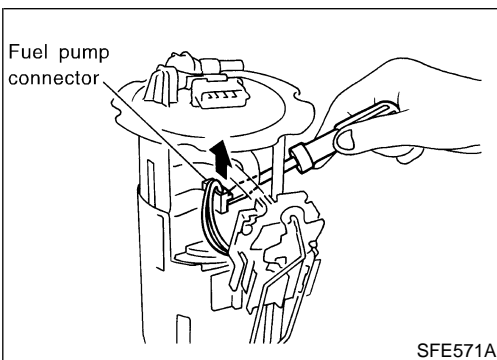

12. Disconnect fuel pump connector.

FUEL SYSTEM

Fuel Pump, Fuel Level Sensor Unit and Fuel Filter (Cont'd)

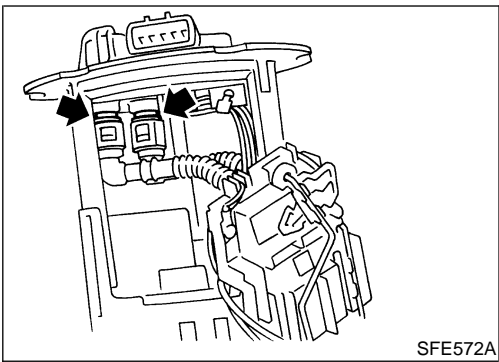

13. Remove quick connectors from fuel level sensor unit.
 - Put mating marks on tubes and connectors for correct installation.

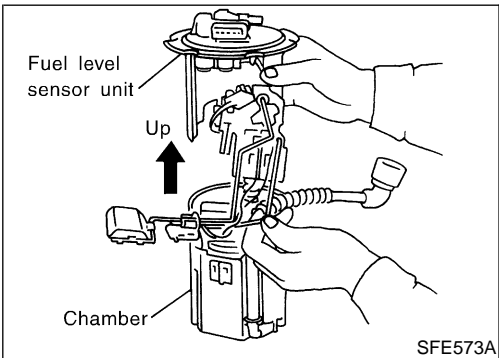

14. Pull up the fuel level sensor unit from chamber.

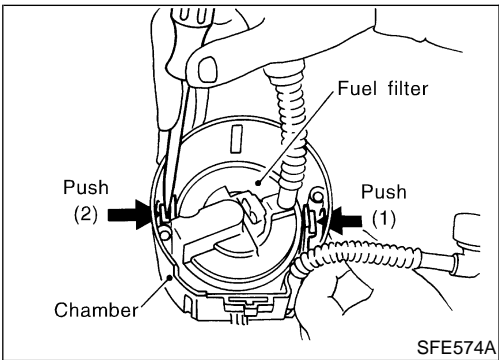

15. Remove fuel filter from chamber.
 - Using a screwdriver, remove the snap fit portion in the order of (1) and (2) as shown in the figure at left.

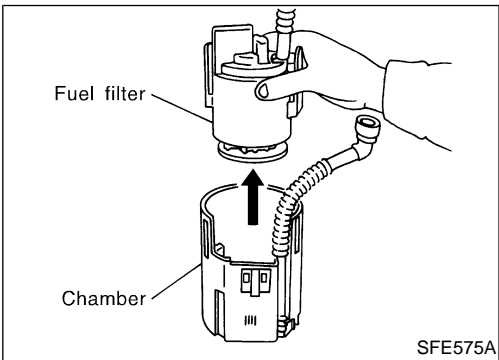

16. Separate the fuel filter and chamber.

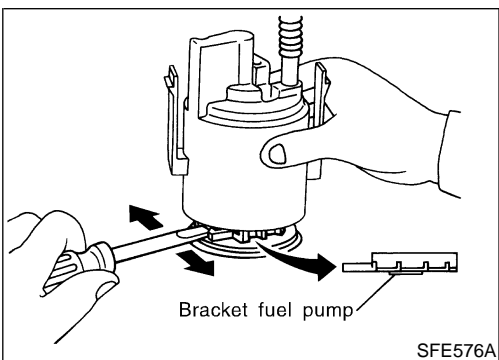

17. Remove fuel pump bracket, then pull out from the fuel filter.

GI

MA

EM

LC

EC

FE

AT

AX

SU

BR

ST

RS

BT

HA

SC

EL

IDX

FUEL SYSTEM

Fuel Pump, Fuel Level Sensor Unit and Fuel Filter (Cont'd)

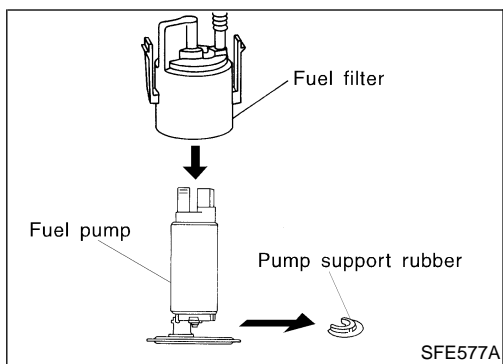

18. Remove fuel pump, then push down the fuel pump as shown in the figure at left.

19. Remove the pump support rubber from the fuel pump.

INSTALLATION

Installation is in reverse order of removal.

NHFE0007S02

EXHAUST SYSTEM

Removal and Installation

NHFE0005

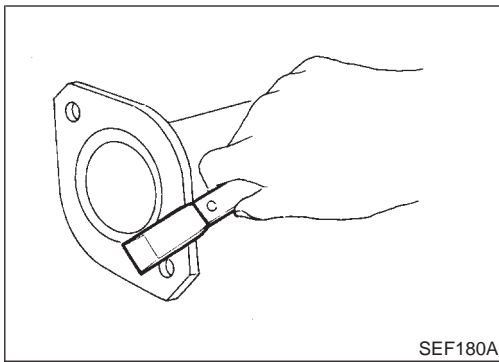

Removal and Installation

CAUTION:

- Always replace exhaust gaskets with new ones when reassembling. If gasket remains on flange surface, scrape off completely as shown at left.
- With engine running, check all tube connections for exhaust gas leaks, and entire system for unusual noises.
- Check to ensure that mounting brackets and mounting insulators are installed properly and free from undue stress. Improper installation could result in excessive noise or vibration.
- Discard any heated oxygen sensor which has been dropped from a height of more than 0.5 m (19.7 in) onto a hard surface such as a concrete floor; use a new one.
- Before installing a new oxygen sensor, clean exhaust system threads using oxygen sensor thread cleaner tool, J-43897-18 or J-43897-12, and apply anti-seize lubricant.
- Do not overtorque the oxygen sensor. Doing so may cause damage to the oxygen sensor, resulting in the MIL coming on.

GI
MA
EM
LC
EC
FE

AT
AX
SU
BR
ST
RS
BT
HA
SC
EL
IDX

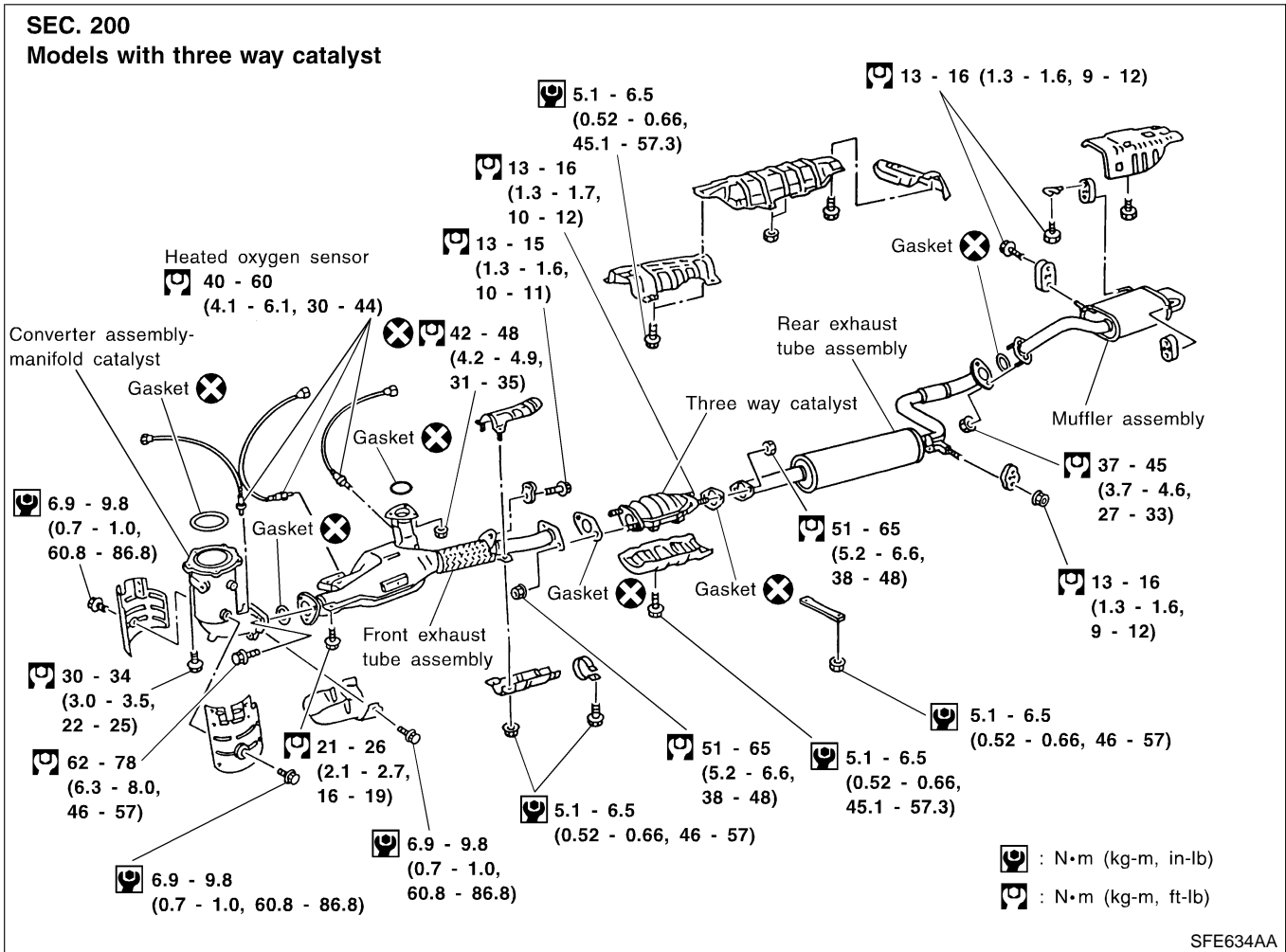

NOTES