

# SECTION MWI

## METER, WARNING LAMP & INDICATOR

A  
B  
C  
D  
E  
F  
G  
H  
I  
J  
K  
L  
M  
O  
P

### CONTENTS

<p><b>BASIC INSPECTION</b> ..... 3</p> <p><b>DIAGNOSIS AND REPAIR WORKFLOW</b> ..... 3</p> <p style="padding-left: 20px;">Work Flow .....3</p> <p><b>FUNCTION DIAGNOSIS</b> ..... 4</p> <p><b>METER SYSTEM</b> ..... 4</p> <p><b>METER SYSTEM</b> .....4</p> <p style="padding-left: 20px;">METER SYSTEM : System Diagram .....4</p> <p style="padding-left: 20px;">METER SYSTEM : System Description .....4</p> <p style="padding-left: 20px;">METER SYSTEM : Arrangement of Combination Meter .....5</p> <p style="padding-left: 20px;">METER SYSTEM : Component Parts Location .....6</p> <p><b>SPEEDOMETER</b> .....8</p> <p style="padding-left: 20px;">SPEEDOMETER : System Diagram .....8</p> <p style="padding-left: 20px;">SPEEDOMETER : System Description .....8</p> <p style="padding-left: 20px;">SPEEDOMETER : Component Parts Location .....8</p> <p><b>FUEL GAUGE</b> .....8</p> <p style="padding-left: 20px;">FUEL GAUGE : System Diagram .....9</p> <p style="padding-left: 20px;">FUEL GAUGE : System Description .....9</p> <p style="padding-left: 20px;">FUEL GAUGE : Component Parts Location .....9</p> <p><b>ODO/TRIP METER</b> .....9</p> <p style="padding-left: 20px;">ODO/TRIP METER : System Diagram .....9</p> <p style="padding-left: 20px;">ODO/TRIP METER : System Description .....9</p> <p style="padding-left: 20px;">ODO/TRIP METER : Component Parts Location.....9</p> <p><b>SHIFT POSITION INDICATOR</b> .....9</p> <p style="padding-left: 20px;">SHIFT POSITION INDICATOR : System Diagram.....9</p> <p style="padding-left: 20px;">SHIFT POSITION INDICATOR : System Description ..... 10</p> <p style="padding-left: 20px;">SHIFT POSITION INDICATOR : Component Parts Location ..... 10</p> <p><b>WARNING LAMPS/INDICATOR LAMPS</b> ..... 10</p> <p style="padding-left: 20px;">WARNING LAMPS/INDICATOR LAMPS : System Diagram ..... 10</p> <p style="padding-left: 20px;">WARNING LAMPS/INDICATOR LAMPS : System Description ..... 10</p>	<p style="padding-left: 20px;">WARNING LAMPS/INDICATOR LAMPS : Component Parts Location .....10</p> <p><b>METER ILLUMINATION CONTROL</b> .....10</p> <p style="padding-left: 20px;">METER ILLUMINATION CONTROL : System Diagram ..... 10</p> <p style="padding-left: 20px;">METER ILLUMINATION CONTROL : System Description ..... 10</p> <p style="padding-left: 20px;">METER ILLUMINATION CONTROL : Component Parts Location ..... 10</p> <p><b>INFORMATION DISPLAY</b> .....11</p> <p style="padding-left: 20px;">INFORMATION DISPLAY : System Diagram .....11</p> <p style="padding-left: 20px;">INFORMATION DISPLAY : System Description ....11</p> <p style="padding-left: 20px;">INFORMATION DISPLAY : Component Parts Location ..... 12</p> <p><b>COMPASS</b> .....13</p> <p style="padding-left: 20px;">Description ..... 13</p> <p><b>DIAGNOSIS SYSTEM (METER)</b> .....15</p> <p style="padding-left: 20px;">Diagnosis Description .....15</p> <p style="padding-left: 20px;">CONSULT-III Function (METER/M&amp;A) .....15</p> <p><b>COMPONENT DIAGNOSIS</b> .....18</p> <p><b>DTC U1000 CAN COMMUNICATION</b> ..... 18</p> <p style="padding-left: 20px;">DTC Logic .....18</p> <p style="padding-left: 20px;">Diagnosis Procedure .....18</p> <p><b>DTC B2205 VEHICLE SPEED CIRCUIT</b> .....19</p> <p style="padding-left: 20px;">Description .....19</p> <p style="padding-left: 20px;">DTC Logic .....19</p> <p style="padding-left: 20px;">Diagnosis Procedure .....19</p> <p><b>POWER SUPPLY AND GROUND CIRCUIT</b> ....20</p> <p><b>COMBINATION METER</b> .....20</p> <p style="padding-left: 20px;">COMBINATION METER : Diagnosis Procedure ....20</p> <p><b>BCM (BODY CONTROL MODULE)</b> .....20</p> <p style="padding-left: 20px;">BCM (BODY CONTROL MODULE) : Diagnosis Procedure .....21</p>
---	--

MWI

<b>IPDM E/R (INTELLIGENT POWER DISTRIBUTION MODULE ENGINE ROOM) .....</b>	<b>21</b>	Diagnosis Procedure .....	51
IPDM E/R (INTELLIGENT POWER DISTRIBUTION MODULE ENGINE ROOM) : Diagnosis Procedure .....	21	<b>THE OIL PRESSURE SWITCH DOES NOT TURN ON .....</b>	<b>52</b>
<b>VEHICLE SPEED SIGNAL CIRCUIT .....</b>	<b>22</b>	Description .....	52
Description .....	22	Diagnosis Procedure .....	52
Diagnosis Procedure .....	22	<b>THE OIL PRESSURE SWITCH DOES NOT TURN OFF .....</b>	<b>53</b>
<b>FUEL LEVEL SENSOR SIGNAL CIRCUIT .....</b>	<b>23</b>	Description .....	53
Description .....	23	Diagnosis Procedure .....	53
Component Function Check .....	23	<b>THE PARKING BRAKE RELEASE WARNING CONTINUES DISPLAYING, OR DOES NOT DISPLAY .....</b>	<b>54</b>
Diagnosis Procedure .....	23	Description .....	54
Component Inspection .....	24	Diagnosis Procedure .....	54
<b>OIL PRESSURE SWITCH SIGNAL CIRCUIT ...</b>	<b>25</b>	<b>THE LOW WASHER FLUID WARNING CONTINUES DISPLAYING, or DOES NOT DISPLAY .....</b>	<b>55</b>
Description .....	25	Description .....	55
Component Function Check .....	25	Diagnosis Procedure .....	55
Diagnosis Procedure .....	25	<b>THE DOOR OPEN WARNING CONTINUES DISPLAYING, OR DOES NOT DISPLAY .....</b>	<b>56</b>
Component Inspection .....	25	Description .....	56
<b>PARKING BRAKE SWITCH SIGNAL CIRCUIT .....</b>	<b>26</b>	Diagnosis Procedure .....	56
Description .....	26	<b>THE AMBIENT TEMPERATURE DISPLAY IS INCORRECT .....</b>	<b>59</b>
Component Function Check .....	26	Description .....	59
Diagnosis Procedure .....	26	Diagnosis Procedure .....	59
Component Inspection .....	26	<b>NORMAL OPERATING CONDITION .....</b>	<b>61</b>
<b>COMPASS .....</b>	<b>27</b>	<b>COMPASS .....</b>	<b>61</b>
Wiring Diagram .....	27	COMPASS : Description .....	61
<b>ECU DIAGNOSIS .....</b>	<b>29</b>	<b>PRECAUTION .....</b>	<b>62</b>
<b>COMBINATION METER .....</b>	<b>29</b>	<b>PRECAUTIONS .....</b>	<b>62</b>
Reference Value .....	29	Supplemental Restraint System (SRS) "AIR BAG" and "SEAT BELT PRE-TENSIONER" .....	62
Wiring Diagram .....	31	<b>ON-VEHICLE REPAIR .....</b>	<b>63</b>
Fail Safe .....	46	<b>COMBINATION METER .....</b>	<b>63</b>
DTC Index .....	47	Removal and Installation .....	63
<b>SYMPTOM DIAGNOSIS .....</b>	<b>48</b>	<b>DISASSEMBLY AND ASSEMBLY .....</b>	<b>65</b>
<b>THE ODO/TRIP METER DOES NOT FUNCTION .....</b>	<b>48</b>	<b>COMBINATION METER .....</b>	<b>65</b>
Description .....	48	Disassembly and Assembly .....	65
Diagnosis Procedure .....	48		
<b>THE FUEL GAUGE POINTER DOES NOT MOVE .....</b>	<b>49</b>		
Description .....	49		
Diagnosis Procedure .....	49		
<b>THE FUEL GAUGE POINTER DOES NOT MOVE TO "F" WHEN REFUELING .....</b>	<b>51</b>		
Description .....	51		

# DIAGNOSIS AND REPAIR WORKFLOW

< BASIC INSPECTION >

## BASIC INSPECTION

### DIAGNOSIS AND REPAIR WORKFLOW

Work Flow

INFOID:000000001503680

DETAILED FLOW

#### 1.CONFIRM SYMPTOM

Confirm symptom or customer complaint.

>> GO TO 2

#### 2.CHECK SELF-DIAGNOSIS OPERATION OF COMBINATION METER

Perform self-diagnosis of combination meter. Refer to [MWI-15. "Diagnosis Description"](#).

Does self-diagnosis mode operate?

YES >> GO TO 3

NO >> Check power supply and ground circuit of combination meter. Refer to [MWI-20. "COMBINATION METER : Diagnosis Procedure"](#). Then, GO TO 4

#### 3.CHECK COMBINATION METER (CONSULT-III)

Select "METER/M&A" on CONSULT-III and perform "SELF-DIAGNOSIS" of combination meter. Refer to [MWI-15. "CONSULT-III Function \(METER/M&A\)"](#).

Self-diagnostic results content

No malfunction detected>>Repair or replace the cause of symptom. Then, GO TO 4

Malfunction detected>>Refer to [MWI-47. "DTC Index"](#). Then, GO TO 4

#### 4.CONFIRM OPERATION

Does the combination meter operate normally?

YES or NO

YES >> Inspection End.

NO >> GO TO 1

A  
B  
C  
D  
E  
F  
G  
H  
I  
J  
K  
L  
M  
O  
P

MWI

# METER SYSTEM

< FUNCTION DIAGNOSIS >

## FUNCTION DIAGNOSIS

METER SYSTEM

METER SYSTEM

METER SYSTEM : System Diagram

INFOID:000000001503681

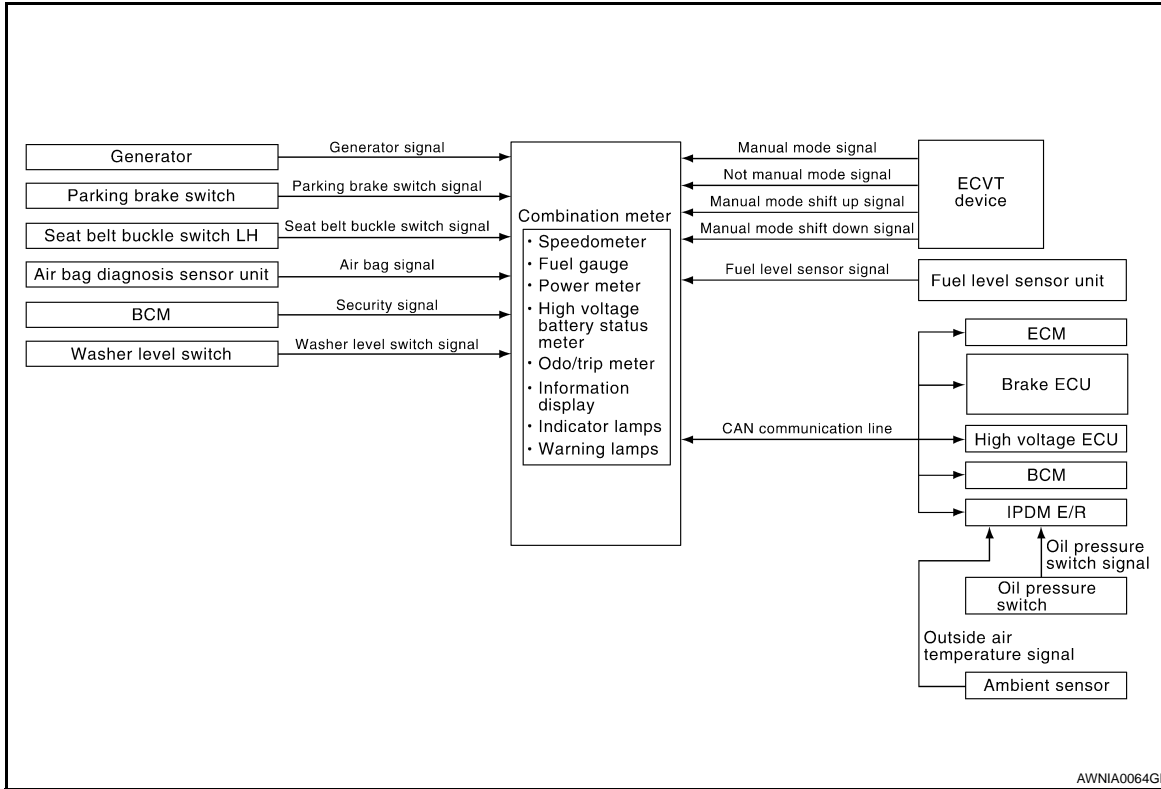

METER SYSTEM : System Description

INFOID:000000001503682

### COMBINATION METER

- Speedometer, odo/trip meter, fuel gauge, power meter, high voltage battery status meter and information display are controlled by the unified meter control unit, which is built into the combination meter.
- Warning and indicator lamps are controlled by the unified meter control unit and by components connected directly to the combination meter.
- Digital meter is adopted for odo/trip meter.\*  
\*The record of the odometer is kept even if the battery cable is disconnected. The record of the trip meter is erased when the battery cable is disconnected.
- Odo/trip meter and information display segments can be checked in diagnosis mode.
- Meter/gauge can be checked in diagnosis mode.

# METER SYSTEM

< FUNCTION DIAGNOSIS >

## METER SYSTEM : Arrangement of Combination Meter

INFOID:000000001503683

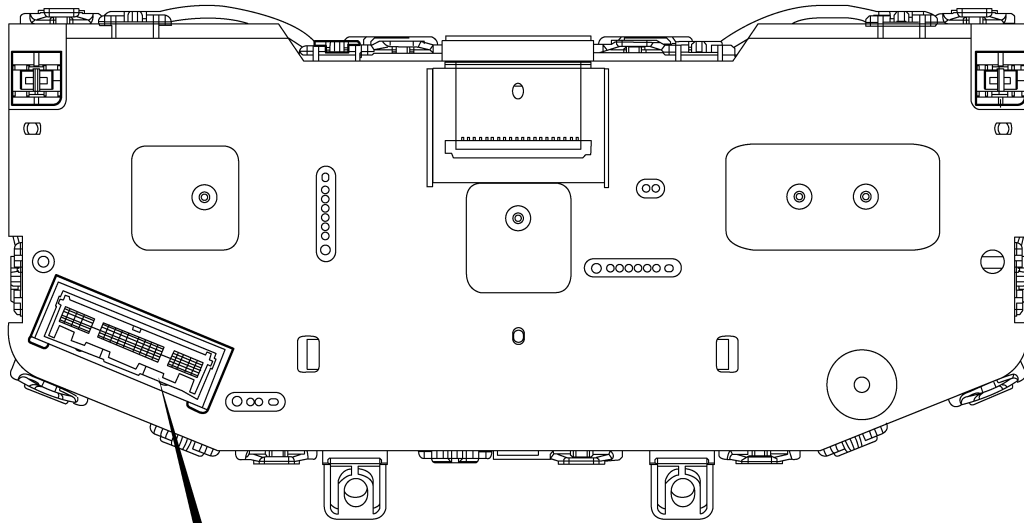
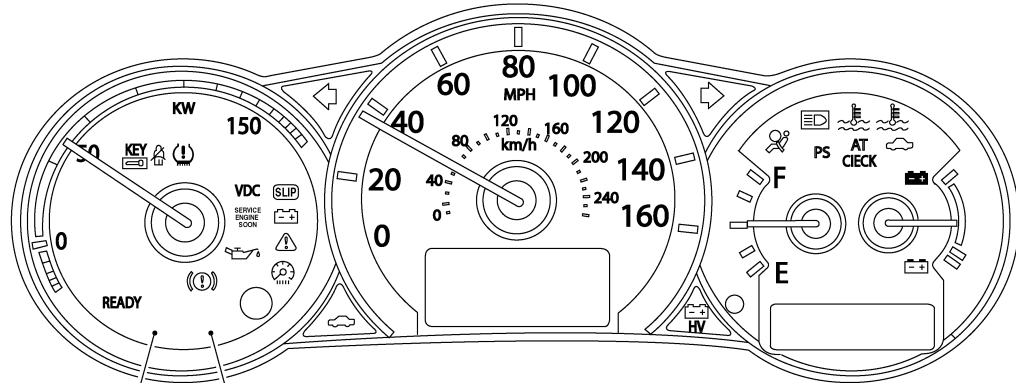

(N) : Canada  
(U) : USA

1	2	3	4	5	6	7	8	9	10	11	12	13	14	15	16	17	18	19	20	(M24)
21	22	23	24	25	26	27	28	29	30	31	32	33	34	35	36	37	38	39	40	

A  
B  
C  
D  
E  
F  
G  
H  
I  
J  
K  
L  
M  
N  
O  
P

MWI

AWNIA0065GB

# METER SYSTEM

< FUNCTION DIAGNOSIS >

---

METER SYSTEM : Component Parts Location

INFOID:000000001503684

# METER SYSTEM

## < FUNCTION DIAGNOSIS >

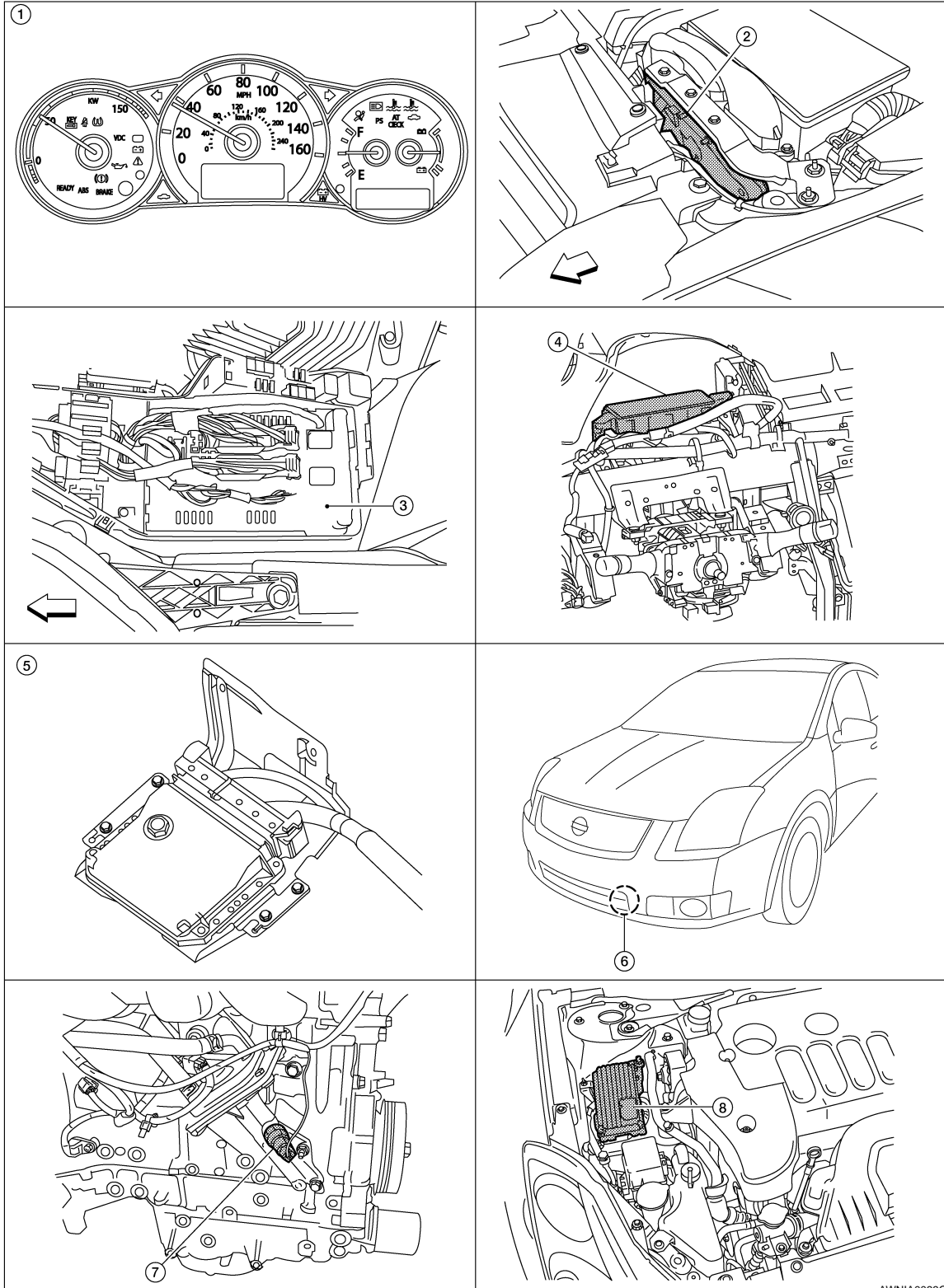

A  
B  
C  
D  
E  
F  
G  
H  
I  
J  
K  
L  
M  
N  
O  
P

MWI

AWNIA0066GB

# METER SYSTEM

## < FUNCTION DIAGNOSIS >

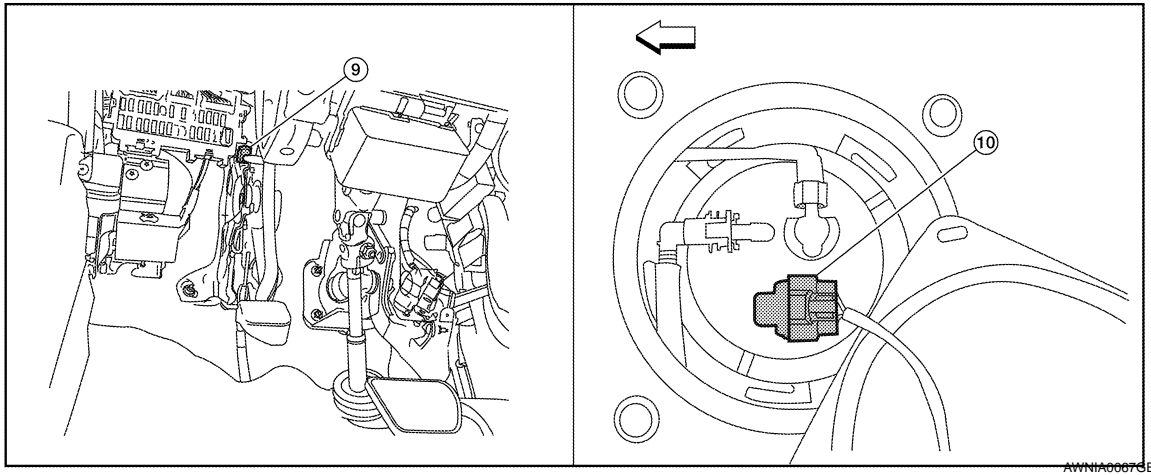

- |  |                         |   |
|--|-------------------------|---|
| 1. Combination meter M24   | 2. ECM E10              | 3. IPDM E/R E17, E18, E201, F10   |
| 4. BCM M17, M18, M19, M21 (view with instrument panel removed)   | 5. High voltage ECU E66 | 6. Ambient sensor E211  |
| 7. Oil pressure switch F41 (view with engine removed)  | 8. Brake ECU E61        | 9. Parking brake switch E35 (view with instrument lower cover LH removed) |
| 10. Fuel level sensor unit and fuel pump (fuel level sensor) B42 (view with rear seat and inspection hole cover removed) |                         |   |

## SPEEDOMETER

### SPEEDOMETER : System Diagram

INFOID:000000001503685

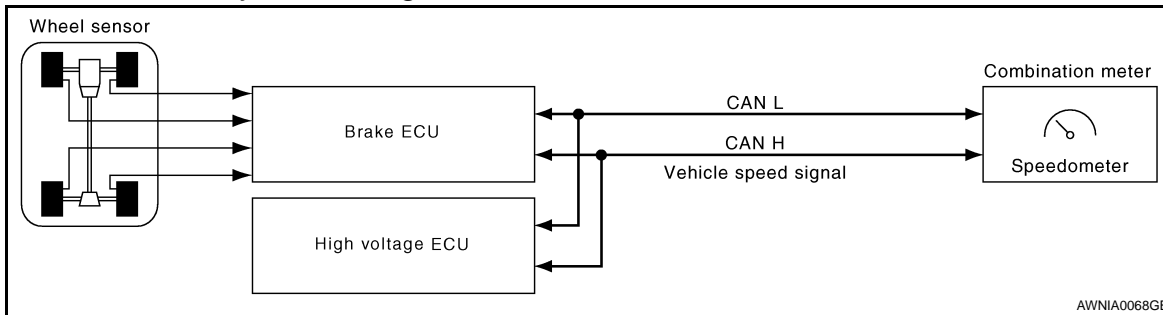

AWNIA0068GE

### SPEEDOMETER : System Description

INFOID:000000001503686

The brake ECU provides a vehicle speed signal to the high voltage ECU via CAN communication lines. The high voltage ECU then sends the vehicle speed signal to the combination meter via CAN communication lines.

### SPEEDOMETER : Component Parts Location

INFOID:000000001503687

Refer to [MWI-6. "METER SYSTEM : Component Parts Location"](#).

## FUEL GAUGE



# METER SYSTEM

< FUNCTION DIAGNOSIS >

## FUEL GAUGE : System Diagram

INFOID:000000001503688

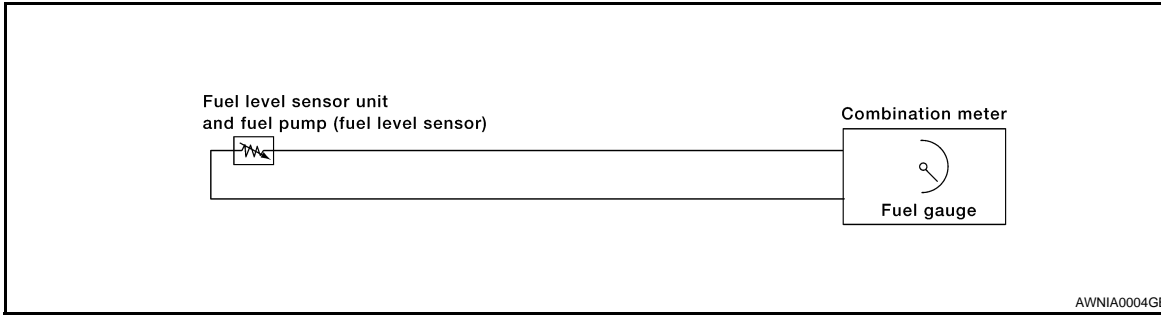

## FUEL GAUGE : System Description

INFOID:000000001503689

The fuel gauge indicates the approximate fuel level in the fuel tank. The fuel gauge is regulated by the unified meter control unit and a variable resistor signal supplied by the fuel level sensor unit.

## FUEL GAUGE : Component Parts Location

INFOID:000000001503690

Refer to [MWI-6, "METER SYSTEM : Component Parts Location"](#).

## ODO/TRIP METER

## ODO/TRIP METER : System Diagram

INFOID:000000001503691

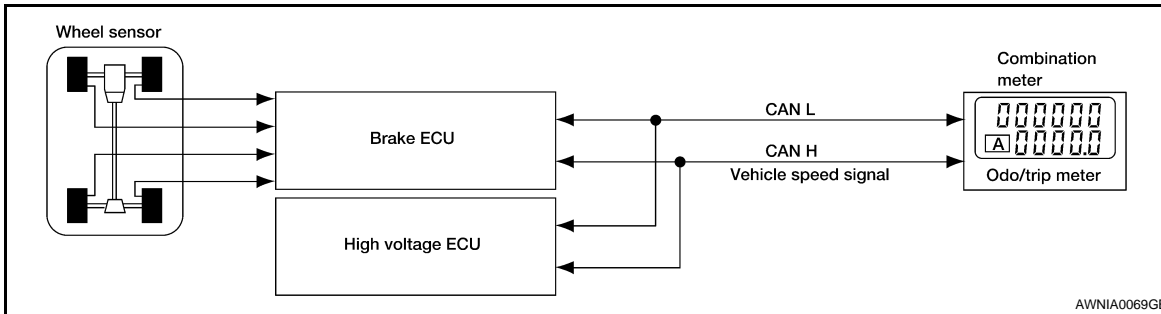

## ODO/TRIP METER : System Description

INFOID:000000001503692

The vehicle speed signal and the memory signals from the meter memory circuit are processed by the combination meter and the mileage is displayed.

## HOW TO CHANGE THE DISPLAY FOR ODO/TRIP METER

Refer to Owner's Manual for odo/trip meter operating instructions.

## ODO/TRIP METER : Component Parts Location

INFOID:000000001503693

Refer to [MWI-6, "METER SYSTEM : Component Parts Location"](#).

## SHIFT POSITION INDICATOR

## SHIFT POSITION INDICATOR : System Diagram

INFOID:000000001503694

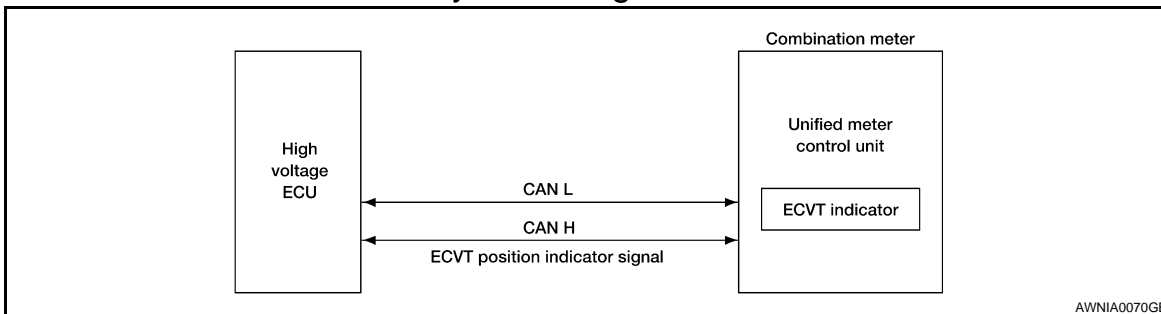

A  
B  
C  
D  
E  
F  
G  
H  
I  
J  
K  
L  
M  
N  
O  
P

# METER SYSTEM

< FUNCTION DIAGNOSIS >

## SHIFT POSITION INDICATOR : System Description

INFOID:000000001503695

The high voltage ECU receives ECVT indicator signals from the park/neutral position (PNP) switch. The high voltage ECU then sends ECVT position indicator signals to the combination meter via CAN communication lines. The combination meter indicates the received shift position.

## SHIFT POSITION INDICATOR : Component Parts Location

INFOID:000000001503696

Refer to [MWI-6, "METER SYSTEM : Component Parts Location"](#).

## WARNING LAMPS/INDICATOR LAMPS

### WARNING LAMPS/INDICATOR LAMPS : System Diagram

INFOID:000000001503697

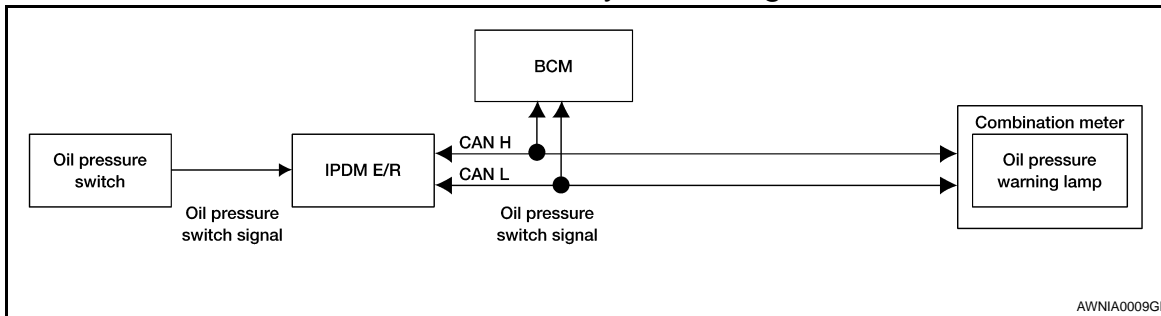

### WARNING LAMPS/INDICATOR LAMPS : System Description

INFOID:000000001503698

#### OIL PRESSURE WARNING LAMP

The oil pressure warning lamp is controlled by the IPDM E/R (intelligent power distribution module engine room).

Low oil pressure causes the oil pressure switch to provide a ground signal to the IPDM E/R. The IPDM E/R then signals the combination meter (unified meter control unit) via the CAN communication lines and ground is provided to the oil pressure warning lamp.

When power and ground are supplied, the oil pressure warning lamp illuminates.

## WARNING LAMPS/INDICATOR LAMPS : Component Parts Location

INFOID:000000001503699

Refer to [MWI-6, "METER SYSTEM : Component Parts Location"](#).

## METER ILLUMINATION CONTROL

### METER ILLUMINATION CONTROL : System Diagram

INFOID:000000001503700

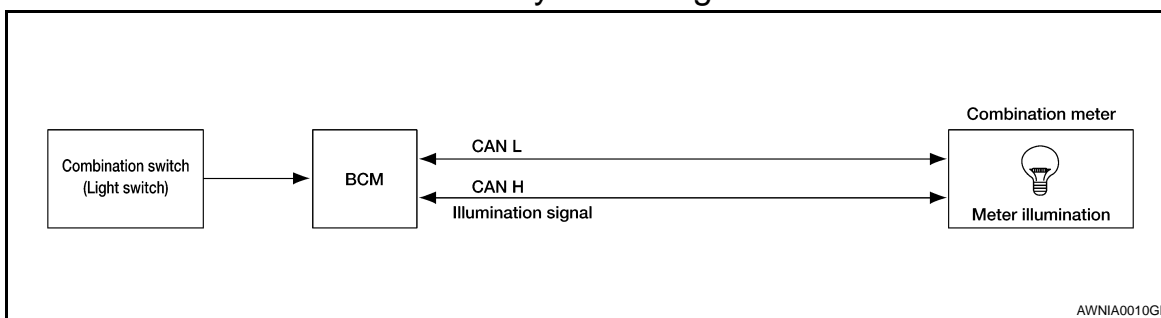

### METER ILLUMINATION CONTROL : System Description

INFOID:000000001503701

The unified meter control unit outputs the speedometer, odometer/trip meters and fuel gauge lighting when the ignition switch is turned on. When the lighting switch is turned on, the illumination control switch can be used to adjust the brightness of the illumination.

## METER ILLUMINATION CONTROL : Component Parts Location

INFOID:000000001503702

Refer to [MWI-6, "METER SYSTEM : Component Parts Location"](#).

# METER SYSTEM

< FUNCTION DIAGNOSIS >

## INFORMATION DISPLAY

### INFORMATION DISPLAY : System Diagram

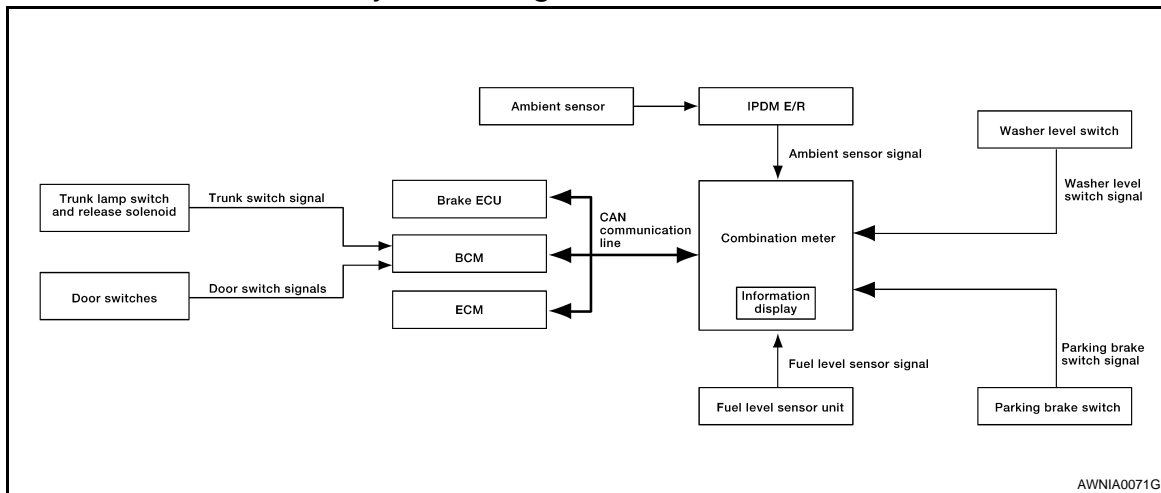

### INFORMATION DISPLAY : System Description

INFOID:000000001503704

#### FUNCTION

The information display can indicate the following items.

- Outside air temperature
- Trip/fuel consumption readings
- Intelligent Key operation information
- Maintenance information
- Warning/Indication messages (Door ajar, low fuel, low washer fluid, parking brake, cruise control)

#### OUTSIDE AIR TEMPERATURE INDICATION

The outside air temperature indication is displayed while the ignition switch is in the ON position. Indication range is between -30 and 55°C (-22 and 131°F). When outside temperature is less than 3°C (37°F), display shows ICY. The indicated temperature is not affected by engine heat. It changes only when one of the following conditions exists.

- When vehicle speed is more than approximately 20 km/h (12 MPH).
- The ignition switch has been turned OFF for more than 3.5 hours.
- When outside air temperature is less than the indicated temperature.

#### MPG

Average fuel consumption indication is calculated using vehicle speed signals from the brake ECU and fuel consumption information from the ECM.

#### MPG/MPH

The average speed mode can be selected to display the average fuel consumption and average speed since last reset. The indications are calculated using vehicle speed signals from the brake ECU and fuel consumption information from the ECM.

#### RANGE

The range indication provides the driver with an estimation of the distance that can be driven before refueling. The range is calculated using signals from the fuel level sensor unit (fuel remaining), ECM (fuel consumption) and vehicle speed signals from the brake ECU.

#### DOOR AJAR WARNING

This warning appears when the Intelligent Key is in the vehicle and any door or the trunk is opened.

#### LOW FUEL WARNING

This warning appears when the fuel level in the fuel tank reaches approximately 12.3 ℓ (3 1/4 US gal, 2 3/4 Imp gal). A variable resistor signal is supplied to the combination meter from the fuel level sensor unit to determine the amount of fuel in the fuel tank.

#### LOW WINDSHIELD WASHER FLUID WARNING

A  
B  
C  
D  
E  
F  
G  
H  
I  
J  
K  
L  
M  
N  
O  
P

# METER SYSTEM

## < FUNCTION DIAGNOSIS >

---

This warning appears when the windshield washer fluid level is low. When the windshield washer fluid level is low, the washer level switch provides a ground signal to the combination meter (unified meter control unit). The message will be displayed after the ignition switch is turned on for 3 minutes. Once fluid is added, the message will stay on for 30 seconds and then turn off.

### PARKING BRAKE INDICATOR

When the ignition switch is in the ON position and the parking brake is applied, the indicator will turn on. When the parking brake is applied, the parking brake switch provides a ground signal to the combination meter (unified meter control unit). Then, when the ignition switch is turned ON and vehicle speed is greater than 5 km/h (3 MPH), the message is displayed.

### CRUISE INDICATOR

The cruise indicator message is displayed when the cruise control main switch is turned on. The ECM provides an ASCD ON signal to the combination meter (unified meter control unit) via CAN communication lines.

### CRUISE SET INDICATOR

The cruise set indicator message is displayed when the vehicle speed is controlled by the ASCD system. The ECM provides an ASCD ON signal to the combination meter (unified meter control unit) via CAN communication lines.

## INFORMATION DISPLAY : Component Parts Location

INFOID:000000001503705

Refer to [MWI-6. "METER SYSTEM : Component Parts Location"](#).

# COMPASS

< FUNCTION DIAGNOSIS >

## COMPASS

### Description

INFOID:000000001503706

### DESCRIPTION

With the ignition switch in the ON position, and the mode (N) switch ON, the compass display will indicate the direction the vehicle is heading.

Vehicle direction is displayed as follows:

- N: north
- E: east
- S: south
- W: west

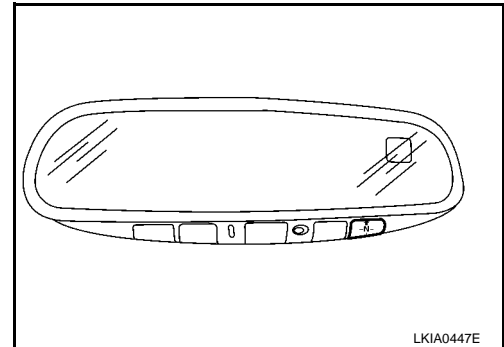

### ZONE VARIATION SETTING PROCEDURE

The difference between magnetic north and geographical north can sometimes be great enough to cause false compass readings. This difference is known as variance. In order for the compass to operate properly (accurately) in a particular zone, the zone variation must be calibrated using the following procedure.

Zone Variation Chart

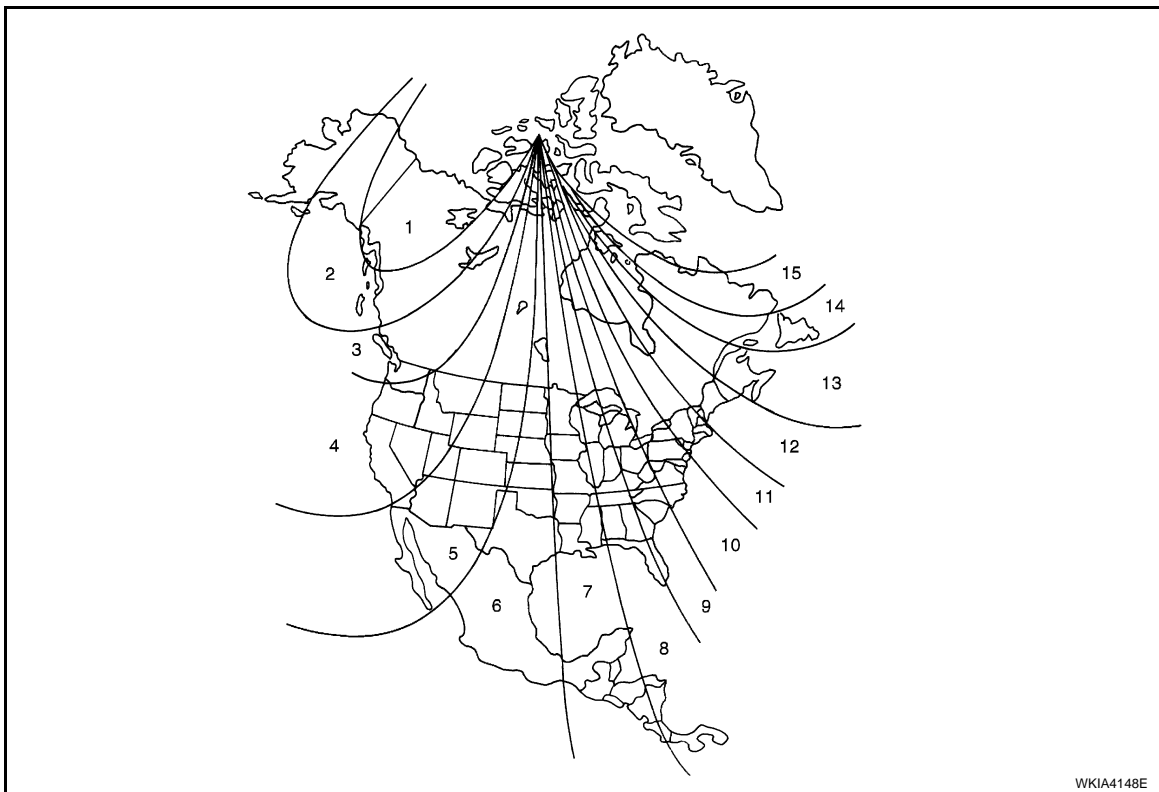

1. Determine your location on the zone map.
2. Turn the ignition switch to the ON position.
3. Press and hold the mode (N) switch for about 5 seconds. The current zone number will appear in the display.
4. Press the mode (N) switch repeatedly until the desired zone number appears in the display.

Once the desired zone number is displayed, stop pressing the mode (N) switch and the display will show a compass direction after a few seconds.

### NOTE:

Use zone number 5 for Hawaii.

### CALIBRATION PROCEDURE

A  
B  
C  
D  
E  
F  
G  
H  
I  
J  
K  
L  
M  
N  
O  
P

MWI

## COMPASS

### < FUNCTION DIAGNOSIS >

The compass display is equipped with an automatic correction function. If the compass display reads "C" or the direction is not shown correctly, perform the correction procedure below.

1. Press and hold the mode (N) switch for about 9 seconds. The display will read "C".
2. Drive the vehicle slowly in a circle, in an open, safe place. The initial calibration is completed in about three turns.

**NOTE:**

In places where the terrestrial magnetism is extremely disturbed, the initial correction may start automatically.

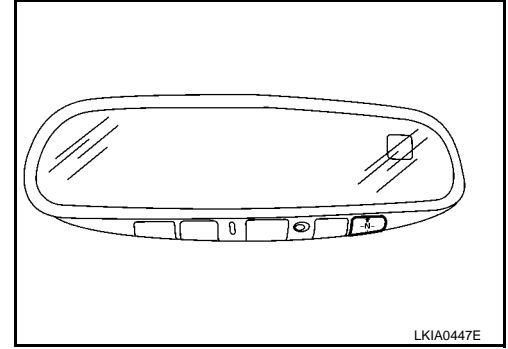

# DIAGNOSIS SYSTEM (METER)

< FUNCTION DIAGNOSIS >

## DIAGNOSIS SYSTEM (METER)

### Diagnosis Description

INFOID:000000001503707

#### SELF-DIAGNOSIS MODE

- Odo/trip meter and information display segment operation can be checked in self-diagnosis mode.
- Meters/gauges can be checked in self-diagnosis mode.

#### OPERATION PROCEDURE

1. Turn the ignition switch OFF.
2. While pushing the odo/trip meter switch, turn the ignition switch ON again.
3. Push the odo/trip meter switch at least 3 times within 7 seconds after the ignition switch is turned ON.
4. The unified meter control unit is turned to self-diagnosis mode.
  - All the segments on the odo/trip meter illuminate.

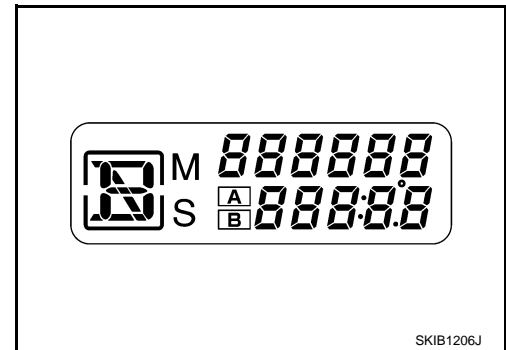

- Dots in all segments of information display LCD (1) flash alternately.

#### NOTE:

If any of the segments are not displayed, replace the combination meter. Refer to [MWI-63, "Removal and Installation"](#).

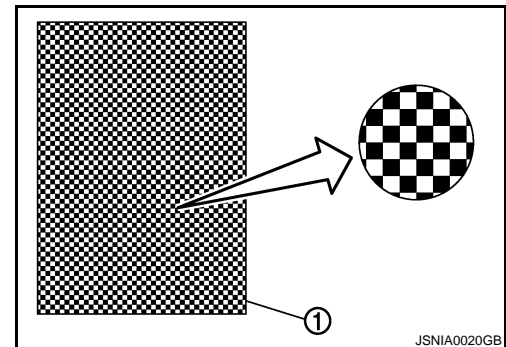

5. Push the odo/trip meter switch. Each meter/gauge should indicate as shown in the figure.

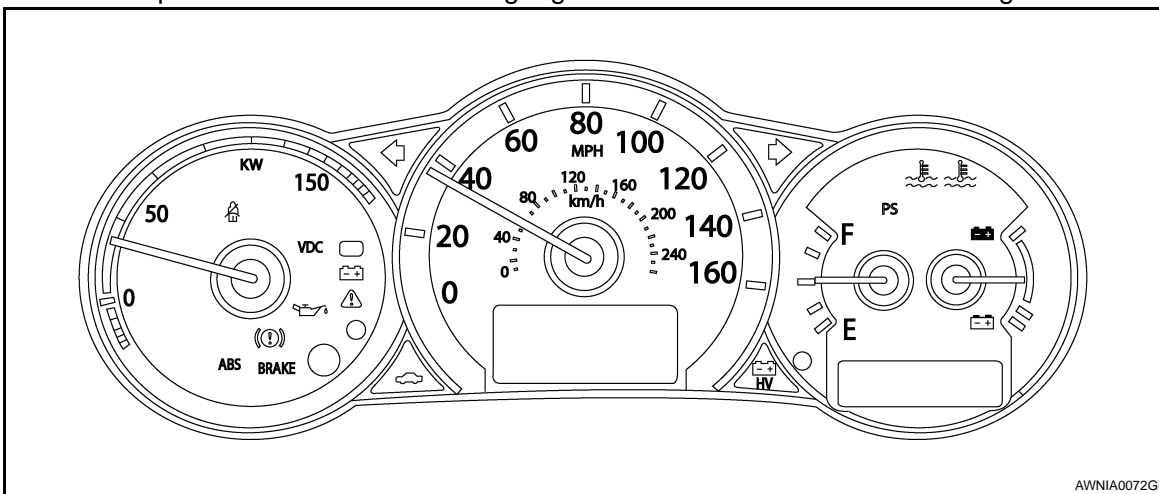

### CONSULT-III Function (METER/M&A)

INFOID:000000001503708

CONSULT-III can display each diagnostic item using the diagnostic test modes shown following.

A  
B  
C  
D  
E  
F  
G  
H  
I  
J  
K  
L  
M  
N  
O  
P

MWI

## DIAGNOSIS SYSTEM (METER)

### < FUNCTION DIAGNOSIS >

METER/M&A diagnosis mode	Description
SELF-DIAG RESULTS	Displays combination meter self-diagnosis results.
DATA MONITOR	Displays combination meter input/output data in real time.
CAN DIAG SUPPORT MNTR	The result of transmit/receive diagnosis of CAN communication can be read.

### SELF-DIAG RESULTS

Display Item List

Refer to [MWI-47, "DTC Index"](#).

### DATA MONITOR

Display Item List

X: Applicable

Display item [Unit]	MAIN SIGNALS	SELECTION FROM MENU	Description
SPEED METER [km/h] or [mph]	X	X	Displays the value of vehicle speed signal.
SPEED OUTPUT [km/h] or [mph]	X	X	Displays the value of vehicle speed signal, which is transmitted to each unit with CAN communication.
ODO OUTPUT		X	Displays the value, which is calculated by vehicle speed signal.
FUEL METER [lit.]	X	X	Displays the value, which processes a resistance signal from fuel gauge.
ABS W/L [ON/OFF]		X	Displays [ON/OFF] condition of ABS warning lamp.
VDC/TCS IND [ON/OFF]		X	Displays [ON/OFF] condition of VDC/TCS OFF indicator lamp.
SLIP IND [ON/OFF]		X	Displays [ON/OFF] condition of SLIP indicator lamp.
HEV BRAKE W/L [ON/OFF]		X	Displays [ON/OFF] condition of HEV brake warning lamp.*
DOOR W/L [ON/OFF]		X	Displays [ON/OFF] condition of door warning lamp.
TRUNK/GLAS-H [ON/OFF]		X	Displays [ON/OFF] condition of trunk warning lamp.
HI-BEAM IND [ON/OFF]		X	Displays [ON/OFF] condition of high beam indicator.
TURN IND [ON/OFF]		X	Displays [ON/OFF] condition of turn indicator.
OIL W/L [ON/OFF]		X	Displays [ON/OFF] condition of oil pressure warning lamp.
MIL [ON/OFF]		X	Displays [ON/OFF] condition of malfunction indicator lamp.
CRUISE IND [ON/OFF]		X	Displays [ON/OFF] condition of CRUISE indicator.
SET IND [ON/OFF]		X	Displays [ON/OFF] condition of SET indicator.
FUEL W/L [ON/OFF]		X	Displays [ON/OFF] condition of low-fuel warning lamp.
WASHER W/L [ON/OFF]		X	Displays [ON/OFF] condition of low-washer fluid warning lamp.
AIR PRES W/L [ON/OFF]		X	Displays [ON/OFF] condition of tire pressure warning lamp.
KEY G W/L [ON/OFF]		X	Displays [ON/OFF] condition of key warning lamp.
PUSH ENG IND		X	Displays the value of Intelligent Key system message indication.
SHIFT IND [P, R, N, D, L]		X	Displays [P, R, N, D, L] range position of ECVT.
PKB SW [ON/OFF]		X	Displays [ON/OFF] condition of parking brake switch.
BUCKLE SW [ON/OFF]		X	Displays [ON/OFF] condition of seat belt buckle switch LH.
DISTANCE [km] or [mile]		X	Displays the value, which is calculated by vehicle speed signal, fuel gauge and fuel consumption from ECM.
OUTSIDE TEMP [°C]		X	Displays the ambient air temperature, which is input from ambient sensor.
FUEL LOW SIG [ON/FF]		X	Displays [ON/OFF] condition of low-fuel warning signal.
BUZZER [ON/OFF]	X	X	Displays [ON/OFF] condition of buzzer.
ALL POWER METER [kw]		X	Displays the value of power meter.
SOC METER [%]		X	Displays the position of the high voltage battery status meter pointer.



## DIAGNOSIS SYSTEM (METER)

### < FUNCTION DIAGNOSIS >

Display item [Unit]	MAIN SIGNALS	SELECTION FROM MENU	Description	A
EPS W/L [ON/OFF]		X	Displays [ON/OFF] condition of EPS warning lamp.	
READY IND [ON/OFF]		X	Displays [ON/OFF] condition of READY indicator.	B
SYS FAIL W/L [ON/OFF]		X	Displays [ON/OFF] condition of hybrid system warning lamp.	
SFT POSI W/L [ON/OFF]		X	Displays [ON/OFF] condition of shift position indicator.	
HV BAT W/L [ON/OFF]		X	Displays [ON/OFF] condition of high voltage battery warning lamp.	C
CHAGE W/L [ON/OFF]		X	Displays [ON/OFF] condition of charge warning lamp.	
LCD		X	Displays the value of Intelligent Key system message indication.	D
BRAKE OIL SW [ON/OFF]		X	Displays [ON/OFF] condition of brake fluid level switch.	

**NOTE:**

Some items are not available due to vehicle specification.

A  
B  
C  
D  
E  
F  
G  
H  
I  
J  
K  
L  
M  
O  
P

MWI

# DTC U1000 CAN COMMUNICATION

< COMPONENT DIAGNOSIS >

## COMPONENT DIAGNOSIS

### DTC U1000 CAN COMMUNICATION

DTC Logic

INFOID:000000001503709

#### DTC DETECTION LOGIC

DTC	CONSULT-III display	Detection condition
U1000	CAN COMM CIRC [U1000]	When combination meter is not transmitting or receiving CAN communication signals for 2 seconds or more.

#### Diagnosis Procedure

INFOID:000000001503710

Symptom: Displays "CAN COMM CIRC [U1000]" as a self-diagnosis result of combination meter.

#### 1. CHECK CAN COMMUNICATION

Select "SELF-DIAG RESULTS" mode for "METER/M&A" with CONSULT-III.

>> Go to "LAN system". Refer to [LAN-16. "Trouble Diagnosis Flow Chart"](#).

# DTC B2205 VEHICLE SPEED CIRCUIT

< COMPONENT DIAGNOSIS >

## DTC B2205 VEHICLE SPEED CIRCUIT

### Description

INFOID:000000001503711

The brake ECU provides a vehicle speed signal to the high voltage ECU via CAN communication lines. The high voltage ECU then sends the vehicle speed signal to the combination meter via CAN communication lines.

### DTC Logic

INFOID:000000001503712

DTC	CONSULT-III display	Detection condition
B2205	VEHICLE SPEED CIRC [B2205]	Malfunction is detected when an erroneous speed signal is input for 2 seconds or more.

### Diagnosis Procedure

INFOID:000000001503713

Symptom: Displays "VEHICLE SPEED CIRC [B2205]" as a self-diagnosis result of combination meter.

#### 1. CHECK COMBINATION METER INPUT SIGNAL

1. Start engine and select "METER/M&A" on CONSULT-III.
2. Using "SPEED METER" on "DATA MONITOR", compare the value of DATA MONITOR with speedometer pointer of combination meter.

Are the speedometer and DATA MONITOR indications close?

- YES >> Perform brake ECU self-diagnosis. Refer to [BRC-45. "CONSULT-III Function"](#).  
NO >> Replace combination meter. Refer to [MWI-63. "Removal and Installation"](#).

A  
B  
C  
D  
E  
F  
G  
H  
I  
J  
K  
L  
M  
O  
P

MWI

# POWER SUPPLY AND GROUND CIRCUIT

< COMPONENT DIAGNOSIS >

## POWER SUPPLY AND GROUND CIRCUIT COMBINATION METER

### COMBINATION METER : Diagnosis Procedure

INFOID:000000001503714

#### 1. CHECK FUSES

Check for blown combination meter fuses.

Unit	Power source	Fuse No.
Combination meter	Battery	11
	Ignition switch ON or START	4
	Ignition switch ACC or ON	19

Are any combination meter fuses blown?

- YES >> Eliminate cause of malfunction before installing new fuse.  
NO >> GO TO 2

#### 2. POWER SUPPLY CIRCUIT CHECK

- Disconnect combination meter connector.
- Check voltage between combination meter harness connector M24 terminals 1, 2, 14 and ground.

Terminals		(-)	Ignition switch position			
(+)	Connector		Terminal	OFF	ACC	ON
M24	1	Ground	Battery voltage	Battery voltage	Battery voltage	Battery voltage
	2		0V	0V	Battery voltage	Battery voltage
	14		0V	Battery voltage	Battery voltage	Battery voltage

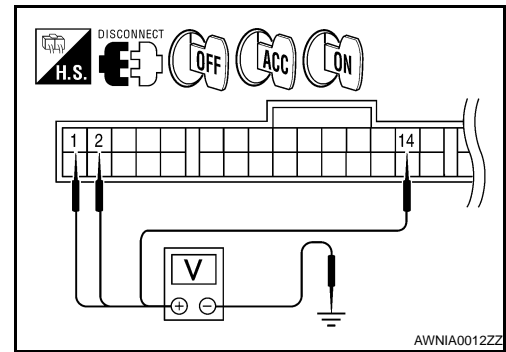

Do test results match chart?

- YES >> GO TO 3  
NO >> Check harness for open between combination meter and fuse.

#### 3. GROUND CIRCUIT CHECK

- Turn ignition switch OFF.
- Check continuity between combination meter harness connector terminals 3, 4, 23 and ground.

Terminals		(-)	Continuity
(+)	Connector		
M24	3	Ground	Yes
	4		
	23		

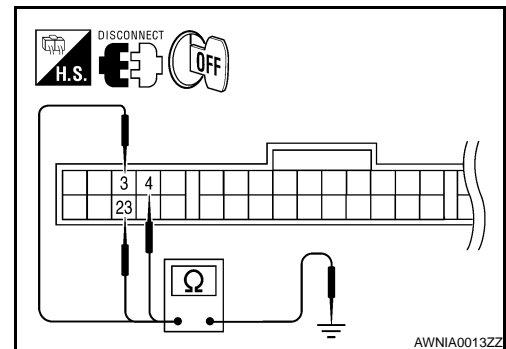

Do test results match chart?

- YES >> Inspection End.  
NO >> Check ground harness.

### BCM (BODY CONTROL MODULE)

# POWER SUPPLY AND GROUND CIRCUIT

< COMPONENT DIAGNOSIS >

BCM (BODY CONTROL MODULE) : Diagnosis Procedure

INFOID:000000001503715

Refer to [BCS-34. "Diagnosis Procedure"](#).

IPDM E/R (INTELLIGENT POWER DISTRIBUTION MODULE ENGINE ROOM)

IPDM E/R (INTELLIGENT POWER DISTRIBUTION MODULE ENGINE ROOM) : Diagnosis Procedure

INFOID:000000001503716

Refer to [PCS-18. "Diagnosis Procedure"](#).

A

B

C

D

E

F

G

H

I

J

K

L

M

MWI

O

P

## VEHICLE SPEED SIGNAL CIRCUIT

< COMPONENT DIAGNOSIS >

---

### VEHICLE SPEED SIGNAL CIRCUIT

#### Description

INFOID:000000001503717

Refer to [MWI-8, "SPEEDOMETER : System Description"](#).

#### Diagnosis Procedure

INFOID:000000001503718

Refer to [MWI-19, "Diagnosis Procedure"](#).

# FUEL LEVEL SENSOR SIGNAL CIRCUIT

< COMPONENT DIAGNOSIS >

## FUEL LEVEL SENSOR SIGNAL CIRCUIT

### Description

INFOID:000000001503719

The fuel level sensor unit and fuel pump detects the approximate fuel level in the fuel tank and transmits the fuel level signal to the combination meter.

### Component Function Check

INFOID:000000001503720

#### 1.COMBINATION METER INPUT SIGNAL

1. Select "METER/M&A" on CONSULT-III.
2. Using "FUEL METER" of "DATA MONITOR", compare the value of DATA MONITOR with fuel gauge pointer of combination meter.

Fuel gauge pointer	Reference value of data monitor [lit.]
Full	Approx. 68
3/4	Approx. 56
1/2	Approx. 38
1/4	Approx. 22
Empty	Approx. 4

Does the data monitor value approximately match the fuel gauge indication?

- YES >> Inspection End.  
 NO >> Replace combination meter. Refer to [MWI-63. "Removal and Installation"](#).

### Diagnosis Procedure

INFOID:000000001503721

#### 1.CHECK HARNESS CONNECTOR

1. Turn ignition switch OFF.
2. Check combination meter and fuel level sensor unit terminals (meter-side and harness-side) for poor connection.

Is connection OK?

- YES >> GO TO 2  
 NO >> Repair or replace terminals or connectors.

#### 2.CHECK FUEL LEVEL SENSOR UNIT CIRCUIT

1. Disconnect combination meter connector and fuel level sensor unit connector.
2. Check continuity between combination meter harness connector (A) and fuel level sensor unit and fuel pump harness connector (B).

A		B		Continuity
Connector	Terminal	Connector	Terminal	
M24	34	B42	2	Yes

3. Check continuity between combination meter harness connector (A) and ground.

A		Ground	Continuity
Connector	Terminal		
M24	34		No

Do test results match charts?

- YES >> GO TO 3  
 NO >> Repair harness or connector.

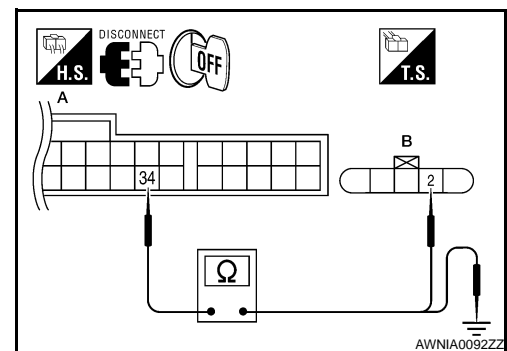

A  
B  
C  
D  
E  
F  
G  
H  
I  
J  
K  
L  
M  
N  
O  
P

MWI

# FUEL LEVEL SENSOR SIGNAL CIRCUIT

## < COMPONENT DIAGNOSIS >

### 3. CHECK FUEL LEVEL SENSOR UNIT GROUND CIRCUIT

1. Check continuity between combination meter harness connector (A) and fuel level sensor unit and fuel pump harness connector (B).

A		B		Continuity
Connector	Terminal	Connector	Terminal	
M24	24	B42	5	Yes

2. Check continuity between combination meter harness connector (A) and ground.

A		Ground	Continuity
Connector	Terminal		
M24	24		No

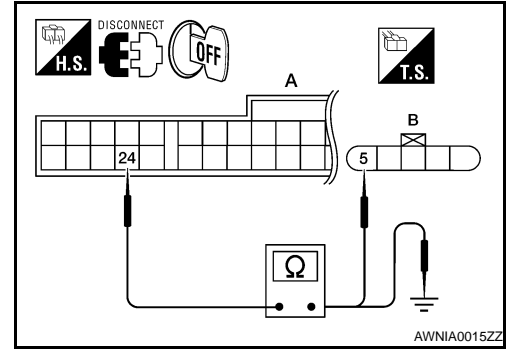

Do test results match charts?

YES >> GO TO 4

NO >> Repair harness or connector.

### 4. CHECK INSTALLATION CONDITION

Check fuel level sensor unit installation, and check whether the float arm interferes or binds with any of the internal components in the fuel tank.

Is the inspection result normal?

YES >> Inspection End.

NO >> Install the fuel level sensor unit properly.

## Component Inspection

INFOID:000000001503722

### 1. REMOVE FUEL LEVEL SENSOR UNIT

Remove the fuel level sensor unit. Refer to [FL-7, "Removal and Installation"](#).

>> GO TO 2

### 2. CHECK FUEL LEVEL SENSOR UNIT AND FUEL PUMP

Check the resistance between terminals 2 and 5.

Terminal		Float position mm (in)		Resistance value (Approx.)
2	5	1*	Full (1)	155.4 (6.1)
		2*	Empty (2)	22.9 (0.9)

1\* and 2\*: When float arm is in contact with stopper.

Is inspection result normal?

YES >> Inspection End.

NO >> Replace fuel level sensor unit and fuel pump. Refer to [FL-7, "Removal and Installation"](#).

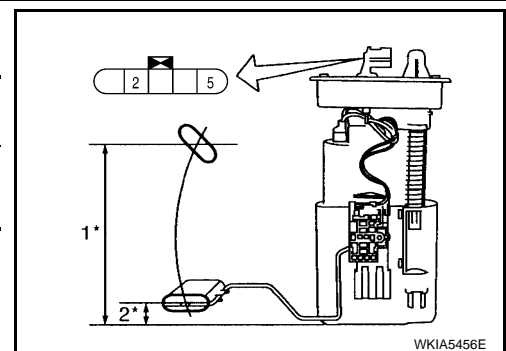



# OIL PRESSURE SWITCH SIGNAL CIRCUIT

< COMPONENT DIAGNOSIS >

## OIL PRESSURE SWITCH SIGNAL CIRCUIT

### Description

INFOID:000000001503723

Detects the engine oil pressure and transmits the oil pressure switch signal to the IPDM E/R.

### Component Function Check

INFOID:000000001503724

#### 1.COMBINATION METER INPUT SIGNAL

1. Select "METER/M&A" on CONSULT-III.
2. Monitor "OIL W/L" of "DATA MONITOR" while operating ignition switch.

#### OIL W/L

When ignition switch is in ON : ON  
position (Engine stopped)

When engine is running : OFF

>> Inspection End.

### Diagnosis Procedure

INFOID:000000001503725

#### 1.CHECK OIL PRESSURE SWITCH CIRCUIT

1. Turn ignition switch OFF.
2. Disconnect IPDM E/R connector F10 and oil pressure switch connector F41.
3. Check continuity between IPDM E/R harness connector F10 (A) terminal 75 and oil pressure switch harness connector F41 (B) terminal 1.

Continuity should exist.

Does continuity exist?

- YES >> Inspection End.  
NO >> Repair harness or connector.

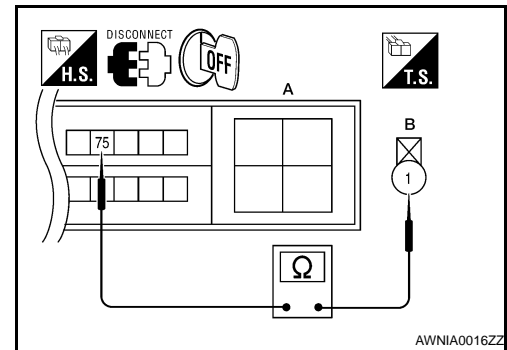

AWNIA0016ZZ

### Component Inspection

INFOID:000000001503726

#### 1.CHECK OIL PRESSURE SWITCH

Check continuity between oil pressure switch and ground.

Condition	Oil pressure [kPa (kg/cm <sup>2</sup> , psi)]	Continuity
Engine stopped	Less than 29 (0.3, 4)	Yes
Engine running	More than 29 (0.3, 4)	No

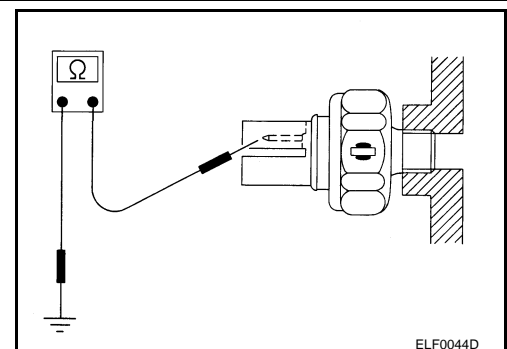

ELF0044D

Is the inspection result normal?

- YES >> Inspection End.  
NO >> Replace the oil pressure switch.

A  
B  
C  
D  
E  
F  
G  
H  
I  
J  
K  
L  
M  
N  
O  
P

MWI

# PARKING BRAKE SWITCH SIGNAL CIRCUIT

< COMPONENT DIAGNOSIS >

## PARKING BRAKE SWITCH SIGNAL CIRCUIT

### Description

INFOID:000000001503727

Transmits the parking brake switch signal to the combination meter.

### Component Function Check

INFOID:000000001503728

#### 1.COMBINATION METER INPUT SIGNAL

1. Select "METER/M&A" on CONSULT-III.
2. Monitor "PKB SW" of "DATA MONITOR" while applying and releasing the parking brake.

#### PKB SW

**Parking brake applied : ON**

**Parking brake released : OFF**

>> Inspection End.

### Diagnosis Procedure

INFOID:000000001503729

#### 1.CHECK PARKING BRAKE SWITCH CIRCUIT

1. Disconnect combination meter connector and parking brake switch connector.
2. Check continuity between combination meter harness connector M24 (A) terminal 26 and parking brake switch harness connector M73 (B) terminal 1.

**26 - 1 : Continuity should exist.**

3. Check continuity between combination meter harness connector M24 (A) terminal 26 and ground.

**26 - Ground : Continuity should not exist.**

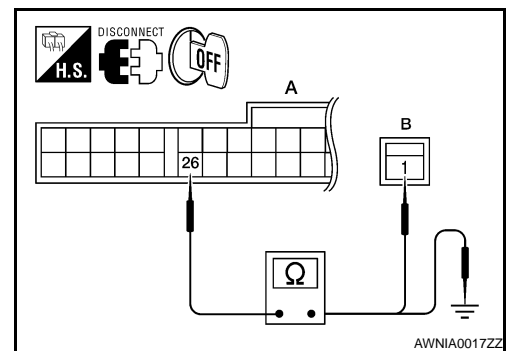

Do test results match specifications?

YES >> Inspection End.

NO >> Repair harness or connector.

### Component Inspection

INFOID:000000001503730

#### 1.CHECK PARKING BRAKE SWITCH

Check continuity between parking brake switch terminal 1 and switch case ground.

Component	Terminal	Condition	Continuity
Parking brake switch	1	Parking brake applied	Yes
		Parking brake released	No

Do test results match chart?

YES >> Inspection End.

NO >> Replace parking brake switch.

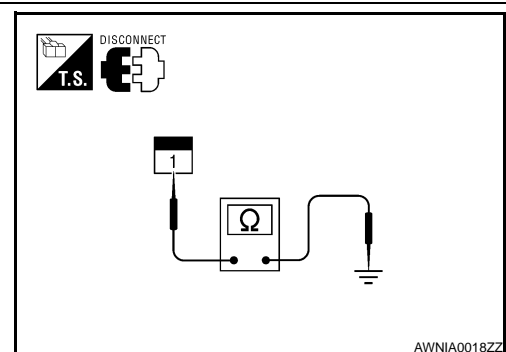

# COMPASS

< COMPONENT DIAGNOSIS >

## COMPASS

### Wiring Diagram

INFOID:000000001503731

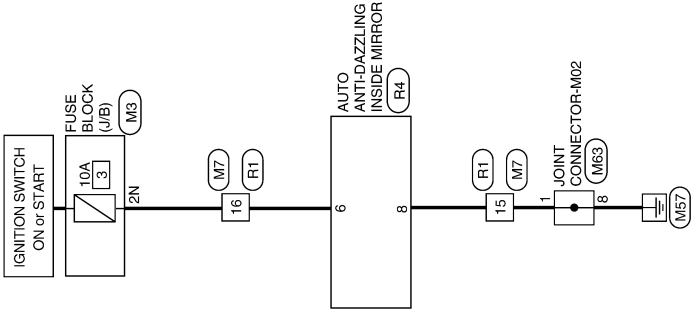

A  
B  
C  
D  
E  
F  
G  
H  
I  
J  
K  
L  
M  
N  
O  
P

COMPASS

MWI

ALNWA0007GE

## COMPASS CONNECTORS

Connector No.	M3
Connector Name	FUSE BLOCK (J/B)
Connector Color	WHITE

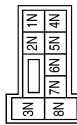

Terminal No.	Color of wire	Signal Name
2N	G	-

Connector No.	M7
Connector Name	WIRE TO WIRE
Connector Color	WHITE

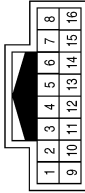

Terminal No.	Color of wire	Signal Name
15	B	-
16	B/R	-

Connector No.	M63
Connector Name	JOINT CONNECTOR M02
Connector Color	BLUE

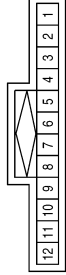

Terminal No.	Color of wire	Signal Name
1	B	-
8	B	-

Connector No.	R1
Connector Name	WIRE TO WIRE
Connector Color	WHITE

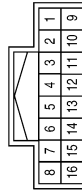

Terminal No.	Color of wire	Signal Name
15	B	-
16	B/R	-

Connector No.	R4
Connector Name	AUTO ANTI-DAZZLING INSIDE MIRROR
Connector Color	BLACK

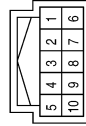

Terminal No.	Color of wire	Signal Name
6	B/R	IGN
8	B	GND

# COMBINATION METER

< ECU DIAGNOSIS >

## ECU DIAGNOSIS

### COMBINATION METER

Reference Value

INFOID:000000001503732

#### TERMINAL LAYOUT

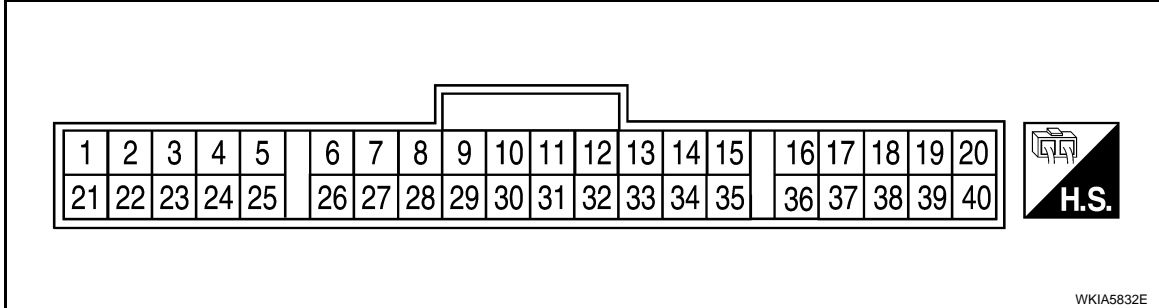

#### PHYSICAL VALUES

Terminal	Wire color	Item	Condition		Reference value (V) (Approx.)
			Ignition switch	Operation or condition	
1	W/L	Battery power supply	—	—	Battery voltage
2	O	Ignition switch ON or START	ON	—	Battery voltage
3	B	Ground (Power)	—	—	0
4	B	Ground (Illumination)			
5	R/Y	Illumination output	—	—	Refer to <a href="#">INL-9, "System Description"</a> .
9	GR/W	Illumination switch power	—	—	Refer to <a href="#">INL-9, "System Description"</a> .
10	O/L	Mode switch ground	ON	—	0
11	L/R	Mode switch A	ON	Switch pressed	0
				Switch released	5
12	B/R	Mode switch B	ON	Switch pressed	0
				Switch released	5
14	V/Y	Ignition switch ACC or ON	ON	—	Battery voltage
15	BR/W	Air bag warning lamp input	ON	Air bag warning lamp ON	3
				Air bag warning lamp OFF	0
18	O/B	Ambient sensor signal	ON	—	0 - 5 (Based on ambient temperature)
20	B/Y	Ambient sensor ground	ON	—	0
21	L	CAN-H	—	—	—
22	P	CAN-L	—	—	—
23	B	Ground (Circuit)	—	—	0
24	B/W	Fuel level sensor ground	ON	—	0
26	G/R	Parking brake switch	ON	Parking brake applied	0
				Parking brake released	Battery voltage
28	L/O	Security indicator input	OFF	Security indicator ON	0
				Security indicator OFF	Battery voltage

# COMBINATION METER

## < ECU DIAGNOSIS >

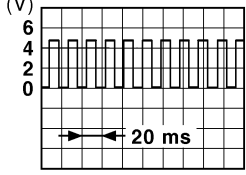
Terminal	Wire color	Item	Condition		Reference value (V) (Approx.)
			Ignition switch	Operation or condition	
29	R	Washer fluid level switch	ON	Washer fluid level low	0
				Washer fluid level normal	Battery voltage
30	L/B	Vehicle speed signal output (2-pulse)	ON	Speedometer operated [When vehicle speed is approx. 20 km/h (12 MPH)]	240 Hz
31	V/W	Vehicle speed signal output (8-pulse)	ON	Speedometer operated [When vehicle speed is approx. 40 km/h (25 MPH)]	<p><b>NOTE:</b> Maximum voltage may be 12V due to specifications (connected units).</p>  <p style="text-align: right; font-size: small;">PKIC0643E</p>
34	G/B	Fuel level sensor signal	—	—	Refer to <a href="#">MWI-9, "FUEL GAUGE : System Description"</a> .
35	W/B	Seat belt buckle switch LH	ON	Unfastened (ON)	0
				Fastened (OFF)	Battery voltage
36	L/W	Seat belt buckle switch RH	ON	Unfastened (ON)	0
				Fastened (OFF)	Battery voltage

# COMBINATION METER

< ECU DIAGNOSIS >

## Wiring Diagram

INFOID:000000001503733

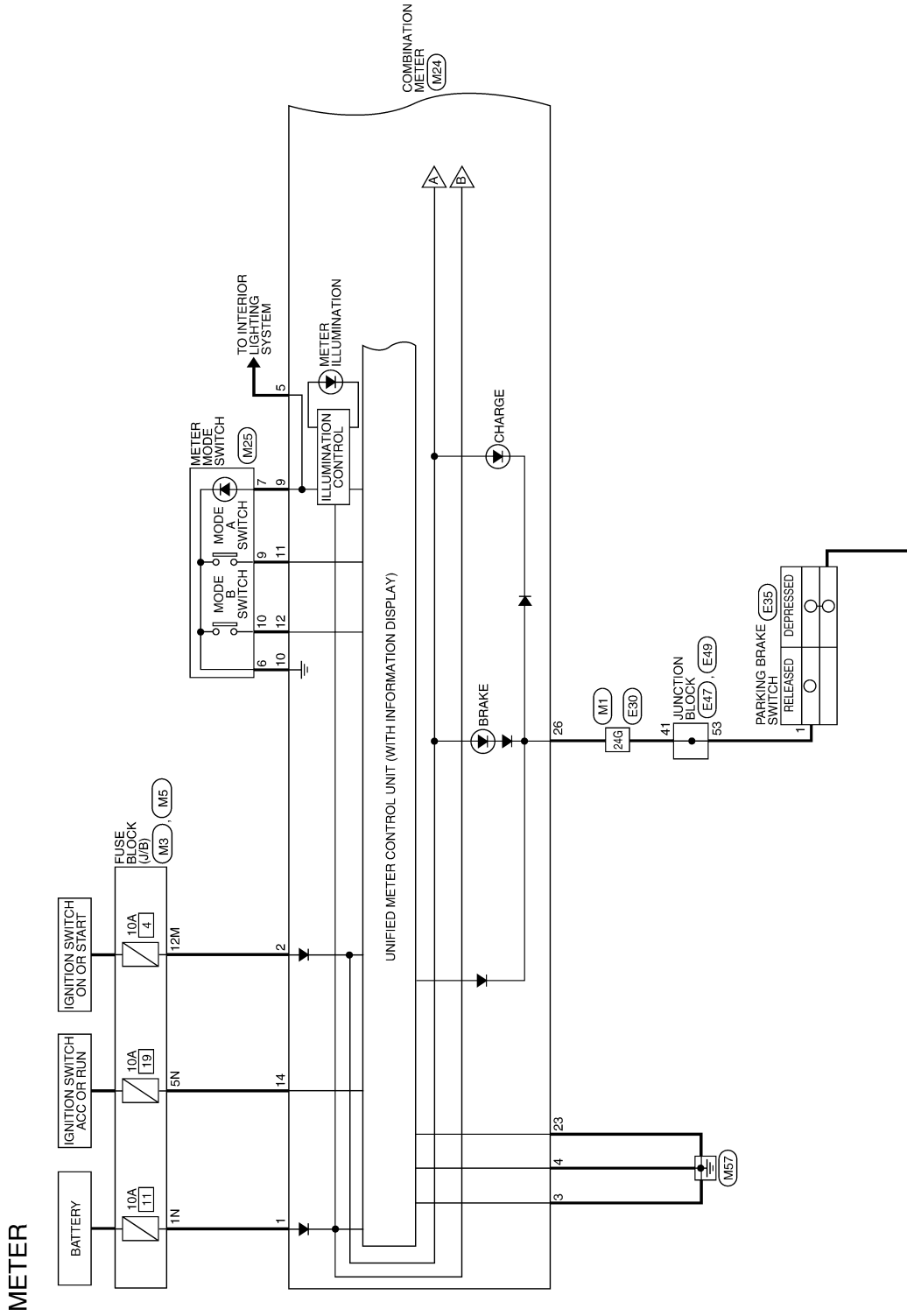

A  
B  
C  
D  
E  
F  
G  
H  
I  
J  
K  
L  
M  
N  
O  
P

MWI

ALNWA0030GE

# COMBINATION METER

< ECU DIAGNOSIS >

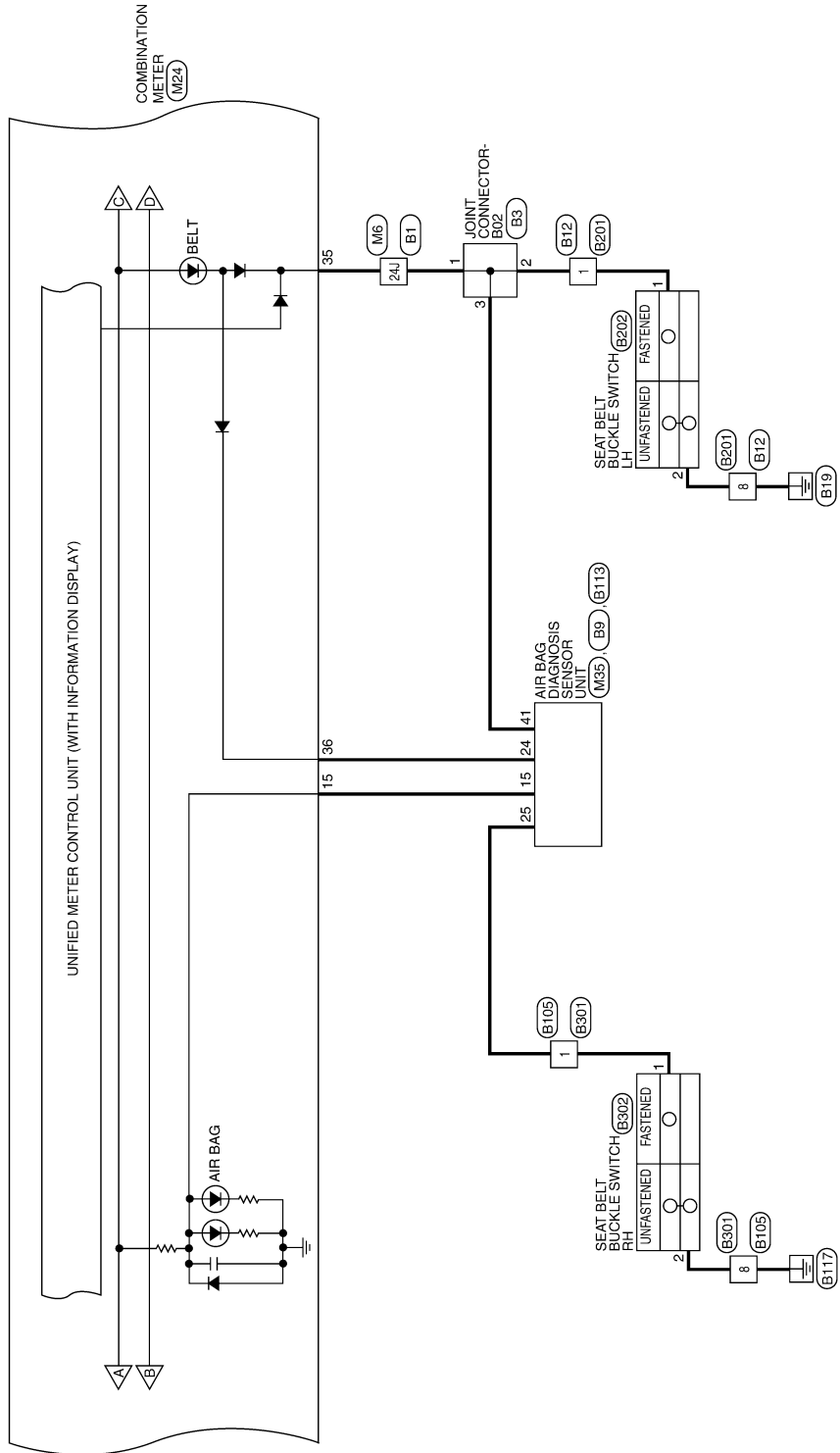

ALNWA0037GE



# COMBINATION METER

< ECU DIAGNOSIS >

--- : DATA LINE

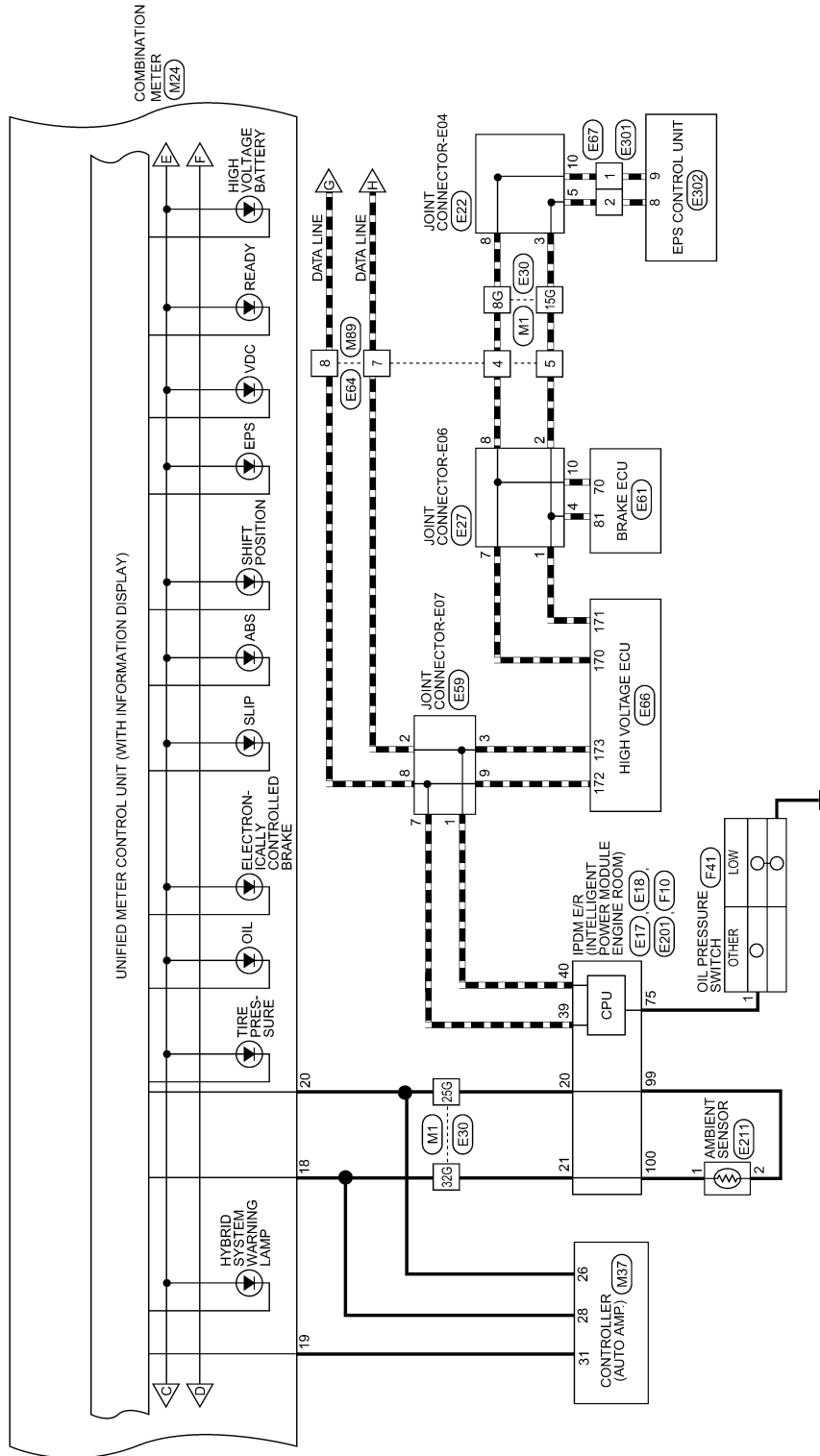

A  
B  
C  
D  
E  
F  
G  
H  
I  
J  
K  
L  
M  
N  
O  
P

MWI

ALNWA0031GE

# COMBINATION METER

< ECU DIAGNOSIS >

---: DATA LINE

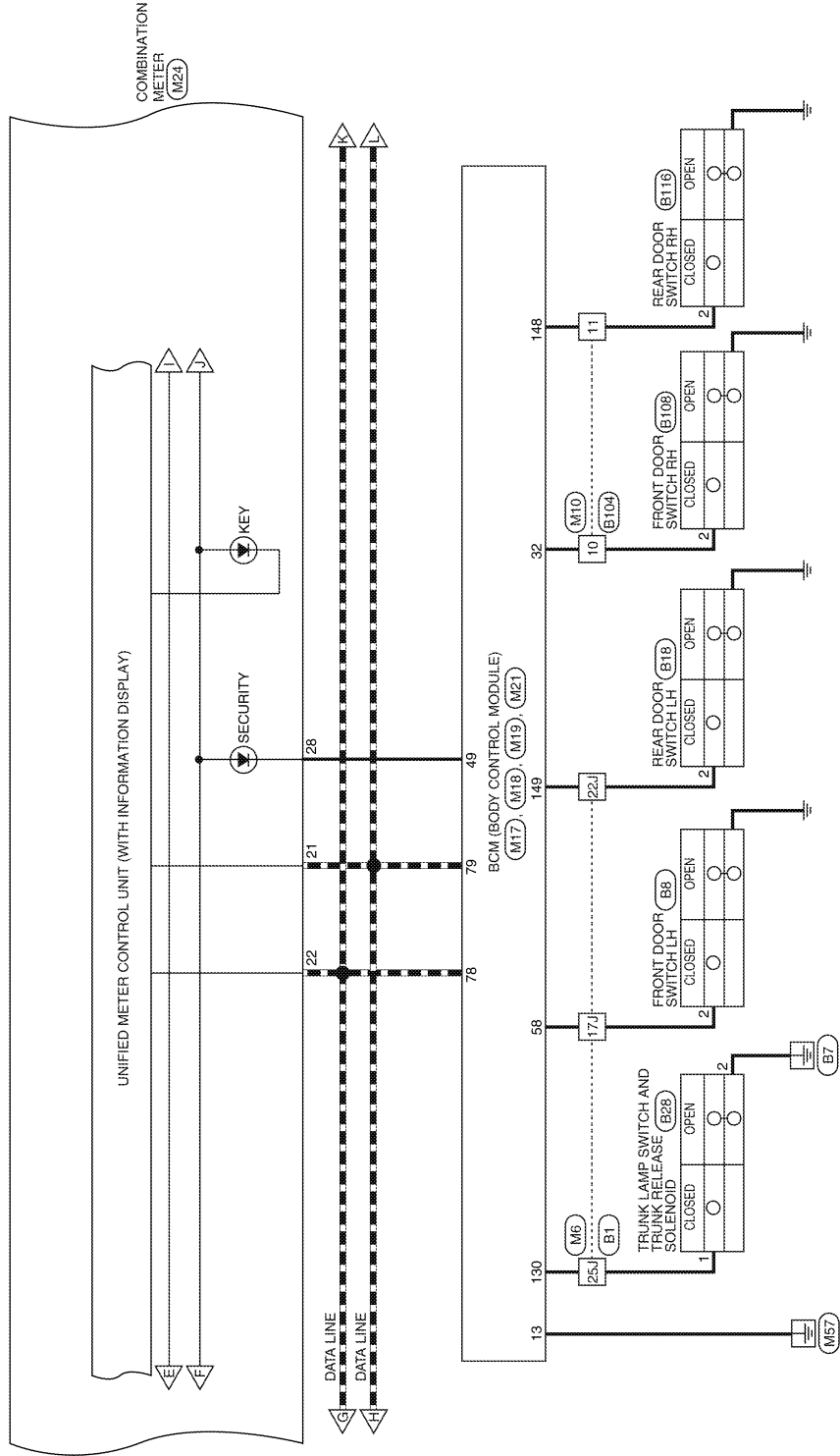

ALNWA0038GE

# COMBINATION METER

< ECU DIAGNOSIS >

--- : DATA LINE

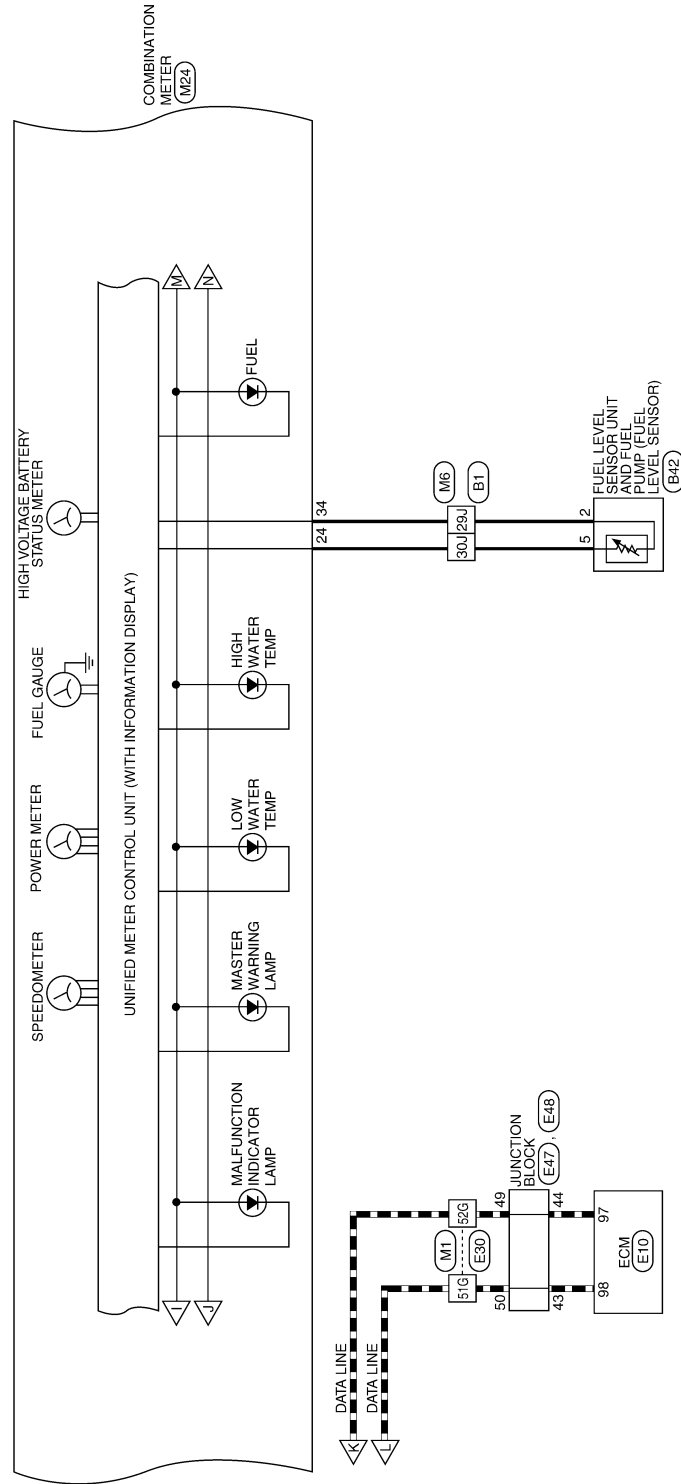

A  
B  
C  
D  
E  
F  
G  
H  
I  
J  
K  
L  
M  
N  
O  
P

MWI

ALNWA0032GE

# COMBINATION METER

< ECU DIAGNOSIS >

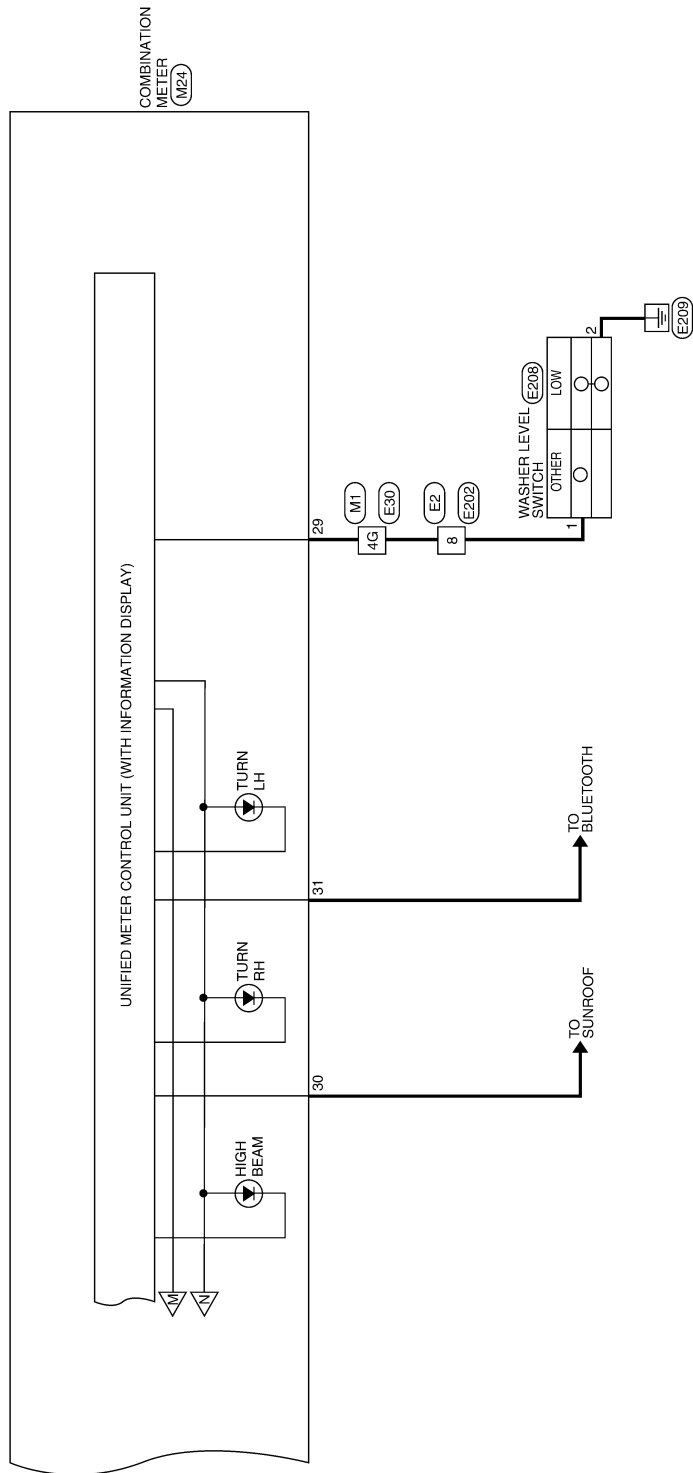

ALNWA0039GE

# COMBINATION METER

< ECU DIAGNOSIS >

## METER CONNECTORS

Connector No.	M1
Connector Name	WIRE TO WIRE
Connector Color	WHITE

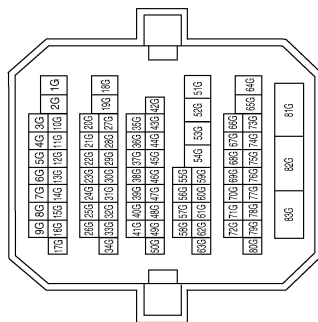

Terminal No.	Color of wire	Signal Name
4G	R	-
8G	BR	-
15G	Y	-
24G	G/R	-
25G	B/Y	-
32G	O/B	-
51G	L	-
52G	P	-

Connector No.	M3
Connector Name	FUSE BLOCK (J/B)
Connector Color	WHITE

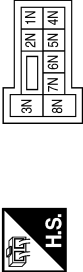

Terminal No.	Color of wire	Signal Name
1N	W/L	-
5N	V/Y	-

Connector No.	M5
Connector Name	FUSE BLOCK (J/B)
Connector Color	WHITE



Terminal No.	Color of wire	Signal Name
12M	O	-

Connector No.	M6
Connector Name	WIRE TO WIRE
Connector Color	WHITE

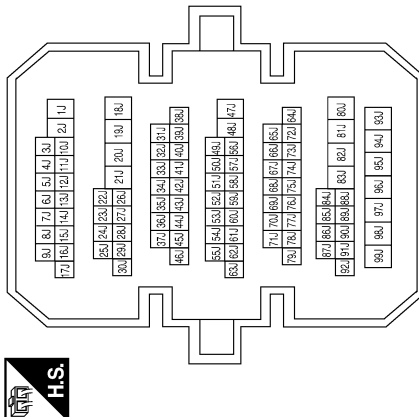

Terminal No.	Color of wire	Signal Name
17J	SB	-
22J	R/B	-
24J	W/B	-
25J	Y/G	-
29J	G/B	-
30J	B/W	-

A  
B  
C  
D  
E  
F  
G  
H  
I  
J  
K  
L  
M  
MWI  
O  
P

# COMBINATION METER

< ECU DIAGNOSIS >

Connector No.	M18
Connector Name	BCM (BODY CONTROL MODULE)
Connector Color	GREEN

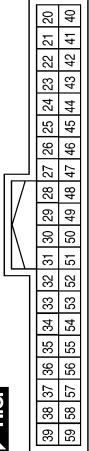
Terminal No.	Color of wire	Signal Name
32	R/B	AS_DOOR_SW
49	L/O	IMMO_LED
58	SB	DR_DOOR_SW

Connector No.	M17
Connector Name	BCM (BODY CONTROL MODULE)
Connector Color	WHITE

Terminal No.	Color of wire	Signal Name
13	B	GND1

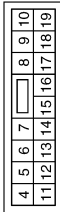
Connector No.	M10
Connector Name	WIRE TO WIRE
Connector Color	BROWN

Terminal No.	Color of wire	Signal Name
10	R/B	-
11	R/W	-

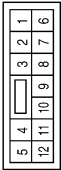
Connector No.	M21
Connector Name	BCM (BODY CONTROL MODULE)
Connector Color	GREY

Terminal No.	Color of wire	Signal Name
130	Y/G	TRUNK_SW
148	R/W	RR_DOOR_SW
149	R/B	RL_DOOR_SW

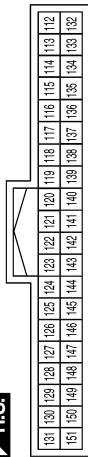
Connector No.	M19
Connector Name	BCM (BODY CONTROL MODULE)
Connector Color	BLACK

Terminal No.	Color of wire	Signal Name
78	P	CAN-L
79	L	CAN-H

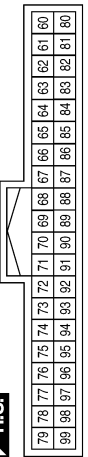
ALNIA0151GB

# COMBINATION METER

< ECU DIAGNOSIS >

Connector No.	M24
Connector Name	COMBINATION METER
Connector Color	WHITE



1	2	3	4	5	6	7	8	9	10	11	12	13	14	15	16	17	18	19	20
21	22	23	24	25	26	27	28	29	30	31	32	33	34	35	36	37	38	39	40

Terminal No.	Color of wire	Signal Name
1	W/L	BAT
2	O	IGN
3	B	GND (POWER)
4	B	GND (ILL)
5	R/Y	ILL OUTPUT
9	GR/W	SW ILL PWR
10	O/L	GND (SATELLITE SW)
11	L/R	MODE A SW
12	B/R	MODE B SW
14	V/Y	ACC
15	BR/W	AIR/BAG
18	O/B	OAT
19	P	OAT POWER
20	B/Y	GND (OAT SENSOR)

Terminal No.	Color of wire	Signal Name
21	L	CAN-H
22	P	CAN-L
23	B	GND (CIRCUIT)
24	B/W	GND (FUEL SENSOR)
26	G/R	PKB
28	L/O	SECURITY
29	R	LOW WASH FLUID SW
30	L/B	2P/R OUT
31	V/W	8P/R OUT
34	G/B	FUEL SENSOR
35	W/B	DR BELT
36	L/W	AS BELT

Connector No.	M25
Connector Name	METER MODE SWITCH
Connector Color	WHITE



1	2	3	4	5
6	7	8	9	10

Terminal No.	Color of wire	Signal Name
6	O/L	GND (SATELLITE SW)
7	GR/W	SW ILL POWER
9	L/R	MODE A SW
10	B/R	MODE B SW

Connector No.	M35
Connector Name	AIR BAG DIAGNOSIS SENSOR UNIT
Connector Color	YELLOW



21	24	49	1						
22	11	46	48	47	45	3	4	6	5
16	12	15	18	2					

Terminal No.	Color of wire	Signal Name
15	BR/W	AIRBAG WL
24	L/W	SEAT BELT REMINDER

Connector No.	M37
Connector Name	CONTROLLER (AUTO AMP.)
Connector Color	WHITE



1	2	3	4	5	6	7	8	9	10	11	12	13	14	15	16	17	18	19	20
21	22	23	24	25	26	27	28	29	30	31	32	33	34	35	36	37	38	39	40

Terminal No.	Color of wire	Signal Name
26	B/Y	SENS GND
28	O/B	AMB SENS
31	P	AMB VDD

ALNIA0152GB

A  
B  
C  
D  
E  
F  
G  
H  
I  
J  
K  
L  
M  
MWI  
O  
P

# COMBINATION METER

< ECU DIAGNOSIS >

Connector No.	M89
Connector Name	WIRE TO WIRE
Connector Color	WHITE



Terminal No.	Color of wire	Signal Name
4	BR	-
5	Y	-
7	L	-
8	P	-

Connector No.	E2
Connector Name	WIRE TO WIRE
Connector Color	WHITE

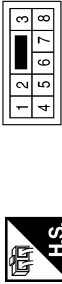

Terminal No.	Color of wire	Signal Name
8	R	-

Connector No.	E10
Connector Name	ECM
Connector Color	BLACK

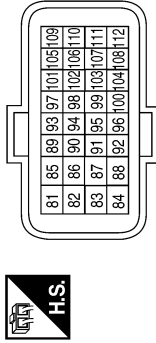

Terminal No.	Color of wire	Signal Name
97	P	CAN-L
98	L	CAN-H

Connector No.	E17
Connector Name	IPDM E/R
Connector Color	WHITE



Terminal No.	Color of wire	Signal Name
39	P	CAN-L
40	L	CAN-H

Connector No.	E18
Connector Name	IPDM E/R
Connector Color	WHITE

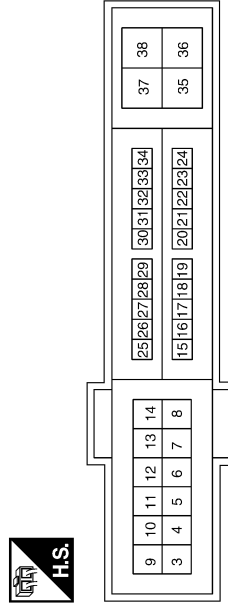

Terminal No.	Color of wire	Signal Name
20	B/Y	AMB_SENS_GND
21	O/B	AMB_SENS_SIG

Connector No.	E22
Connector Name	JOINT CONNECTOR-E04
Connector Color	BLACK



Terminal No.	Color of wire	Signal Name
3	Y	-
5	Y	-
8	BR	-
10	BR	-

ALNIA0153GB



# COMBINATION METER

< ECU DIAGNOSIS >

Connector No.	E27
Connector Name	JOINT CONNECTOR-E06
Connector Color	BLUE

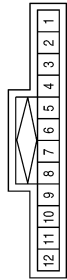

Terminal No.	Color of wire	Signal Name
1	Y	-
2	Y	-
4	Y	-
7	BR	-
8	BR	-
10	BR	-

Connector No.	E30
Connector Name	WIRE TO WIRE
Connector Color	WHITE

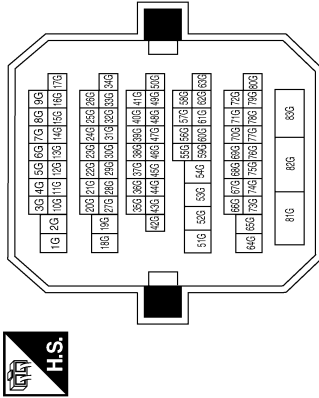

Terminal No.	Color of wire	Signal Name
4G	R	-
8G	P	-
15G	L	-
24G	G/R	-
25G	V	-
32G	O/B	-
51G	L	-
52G	P	-

Connector No.	E35
Connector Name	PARKING BRAKE SWITCH
Connector Color	BLACK



Terminal No.	Color of wire	Signal Name
1	G/R	-

Connector No.	E47
Connector Name	JUNCTION BLOCK
Connector Color	WHITE

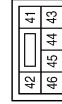

Terminal No.	Color of wire	Signal Name
41	G/R	-
43	L	-
44	P	-

Connector No.	E48
Connector Name	JUNCTION BLOCK
Connector Color	WHITE

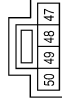

Terminal No.	Color of wire	Signal Name
49	P	-
50	L	-

ALNIA0154GB

A  
B  
C  
D  
E  
F  
G  
H  
I  
J  
K  
L  
M  
MWI  
O  
P

# COMBINATION METER

< ECU DIAGNOSIS >

Connector No.	E49
Connector Name	JUNCTION BLOCK
Connector Color	BROWN

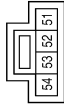

Terminal No.	Color of wire	Signal Name
53	G/R	-

Connector No.	E59
Connector Name	JOINT CONNECTOR-E06
Connector Color	BLUE

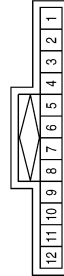

Terminal No.	Color of wire	Signal Name
1	L	-
2	L	-
3	L	-
7	P	-
8	P	-
9	P	-

Connector No.	E61
Connector Name	BRAKE ECU
Connector Color	BLACK

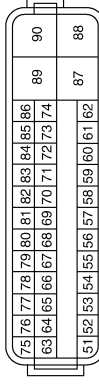

Terminal No.	Color of wire	Signal Name
70	BR	CAN-L
81	Y	CAN-H

Connector No.	E64
Connector Name	WIRE TO WIRE
Connector Color	WHITE

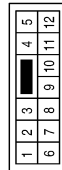

Terminal No.	Color of wire	Signal Name
4	BR	-
5	Y	-
7	L	-
8	P	-

Connector No.	E66
Connector Name	HIGH VOLTAGE ECU
Connector Color	BLACK

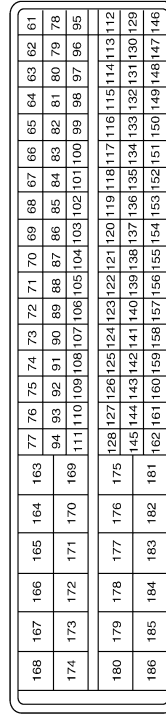

Terminal No.	Color of wire	Signal Name
170	BR	CAN-L
171	Y	CAN-H
172	P	CAN-L
173	L	CAN-H

ALNIA0155GB

# COMBINATION METER

< ECU DIAGNOSIS >

Connector No.	E202
Connector Name	WIRE TO WIRE
Connector Color	WHITE

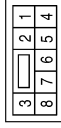

Terminal No.	Color of wire	Signal Name
8	R	-

Connector No.	E201
Connector Name	IPDM E/R
Connector Color	WHITE

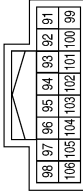

Terminal No.	Color of wire	Signal Name
99	BR/W	AMB_SENS_GND-FEM
100	SB	AMB_SENS_SIG-FEM

Connector No.	E67
Connector Name	WIRE TO WIRE
Connector Color	BLACK

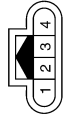

Terminal No.	Color of wire	Signal Name
1	BR	-
2	Y	-

Connector No.	E301
Connector Name	WIRE TO WIRE
Connector Color	BLACK

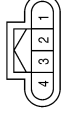

Terminal No.	Color of wire	Signal Name
1	BR	-
2	Y	-

Connector No.	E211
Connector Name	AMBIENT SENSOR
Connector Color	BLACK



Terminal No.	Color of wire	Signal Name
1	SB	AMB_SENS_SIG
2	BRW	AMB_SENS_GND

Connector No.	E208
Connector Name	WASHER LEVEL SWITCH
Connector Color	WHITE



Terminal No.	Color of wire	Signal Name
1	R	WASHER
2	B	GND

ALNIA0156GB

A  
B  
C  
D  
E  
F  
G  
H  
I  
J  
K  
L  
M  
N  
O  
P

# COMBINATION METER

< ECU DIAGNOSIS >

Terminal No.	Color of wire	Signal Name
75	P/L	OIL_PRESSURE_SW

Connector No.	F10
Connector Name	IPDM E/R
Connector Color	WHITE

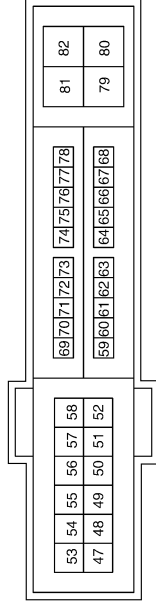

Connector No.	E302
Connector Name	EPS CONTROL UNIT
Connector Color	BLACK

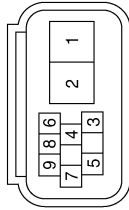

Terminal No.	Color of wire	Signal Name
8	Y	CAN-H
9	BR	CAN-L

Terminal No.	Color of wire	Signal Name
17J	SB	-
22J	R/B	-
24J	W/B	-
25J	Y/G	-
29J	G/B	-
30J	B/W	-

Connector No.	B1
Connector Name	WIRE TO WIRE
Connector Color	WHITE

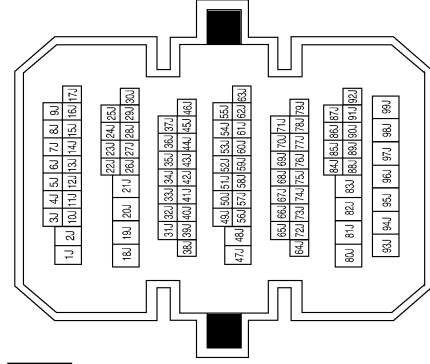

Connector No.	F41
Connector Name	OIL PRESSURE SWITCH
Connector Color	GRAY



Terminal No.	Color of wire	Signal Name
1	P/L	-

ALNIA0157GB

# COMBINATION METER

< ECU DIAGNOSIS >

Connector No.	B9
Connector Name	AIR BAG DIAGNOSIS SENSOR UNIT
Connector Color	YELLOW

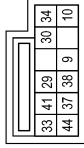

Terminal No.	Color of wire	Signal Name
41	W/B	LH BUCKLE SW INPUT

Connector No.	B8
Connector Name	FRONT DOOR SWITCH LH
Connector Color	WHITE

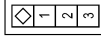

Terminal No.	Color of wire	Signal Name
2	SB	DOOR SW (DR)

Connector No.	B3
Connector Name	JOINT CONNECTOR-B02
Connector Color	WHITE



Terminal No.	Color of wire	Signal Name
1	W/B	-
2	W/B	-
3	W/B	-

Connector No.	B28
Connector Name	TRUNK LAMP SWITCH AND TRUNK RELEASE SOLENOID
Connector Color	WHITE



Terminal No.	Color of wire	Signal Name
1	Y/G	TRUNK_REQUEST_SW
2	B	GND

Connector No.	B18
Connector Name	REAR DOOR SWITCH LH
Connector Color	WHITE

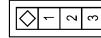

Terminal No.	Color of wire	Signal Name
2	R/B	DOOR SW (RL)

Connector No.	B12
Connector Name	WIRE TO WIRE
Connector Color	WHITE

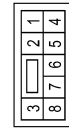

Terminal No.	Color of wire	Signal Name
1	W/B	-
8	B	-

Connector No.	B105
Connector Name	WIRE TO WIRE
Connector Color	WHITE



Terminal No.	Color of wire	Signal Name
1	L/B	-
8	B/Y	-

Connector No.	B104
Connector Name	WIRE TO WIRE
Connector Color	BROWN

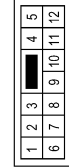

Terminal No.	Color of wire	Signal Name
10	R/G	-
11	R/W	-

Connector No.	B42
Connector Name	FUEL LEVEL SENSOR
Connector Color	GRAY

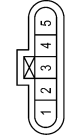

Terminal No.	Color of wire	Signal Name
2	G/B	FUEL_GND
5	B/W	FUEL_SIGNAL

ALNIA0158GB

A  
B  
C  
D  
E  
F  
G  
H  
I  
J  
K  
L  
M  
N  
O  
P



# COMBINATION METER

< ECU DIAGNOSIS >

Connector No.	B116
Connector Name	REAR DOOR SWITCH RH
Connector Color	WHITE

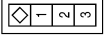
Terminal No.	Color of wire	Signal Name
2	R/W	DOOR SW (RH)

Connector No.	B113
Connector Name	AIR BAG DIAGNOSIS SENSOR UNIT
Connector Color	YELLOW

Terminal No.	Color of wire	Signal Name
25	L/B	RH BUCKLE SW INPUT

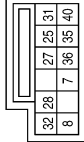
Connector No.	B108
Connector Name	FRONT DOOR SWITCH RH
Connector Color	WHITE

Terminal No.	Color of wire	Signal Name
2	R/G	DOOR SW (AS)

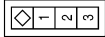
Connector No.	B301
Connector Name	WIRE TO WIRE
Connector Color	WHITE

Terminal No.	Color of wire	Signal Name
1	L	-
8	B	-

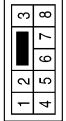
Connector No.	B202
Connector Name	SEAT BELT BUCKLE SWITCH
Connector Color	WHITE

Terminal No.	Color of wire	Signal Name
1	W/B	SIGNAL
2	B	GND

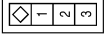
Connector No.	B201
Connector Name	WIRE TO WIRE
Connector Color	WHITE

Terminal No.	Color of wire	Signal Name
1	W/B	-
8	B	-

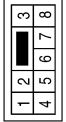
Terminal No.	Color of wire	Signal Name
1	L	SIGNAL
2	B	GND

Connector No.	B302
Connector Name	SEAT BELT BUCKLE SWITCH -RH
Connector Color	WHITE

Terminal No.	Color of wire	Signal Name
1	L	SIGNAL
2	B	GND

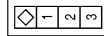
ALNIA0159GB

INFOID:000000001503734

## Fail Safe

The combination meter performs a fail-safe operation for the functions listed below when communication is lost.

# COMBINATION METER

## < ECU DIAGNOSIS >

Function		Specifications	
Speedometer		Zero indication.	A
Fuel gauge			B
Power meter			C
High voltage battery status meter			D
Illumination control	Meter illumination	Change to nighttime mode when communication is lost.	
Segment LCD	Odometer	Freeze current indication.	D
	ECVT position	Display turns off.	
Buzzer		Buzzer turns off.	
Warning lamp/indicator lamp	ABS warning lamp	Lamp turns on when communication is lost.	E
	Brake warning lamp		F
	TCS/VDC OFF indicator lamp		
	SLIP indicator lamp		
	Oil pressure warning lamp	Lamp turns off when communication is lost.	G
	Malfunction indicator lamp		H
	Master warning lamp		
	Air bag warning lamp		
	High beam indicator		
	Turn signal indicator lamp		
	Intelligent Key system warning lamp	Lamp turns off when disconnected.	I
	Driver and passenger seat belt warning lamp		J
	Charge warning lamp		
	Security indicator lamp		
Low tire pressure warning lamp	Lamp will flash every second for 1 minute and then stay on continuously thereafter.	K	

## DTC Index

INFOID:000000001503735

CONSULT-III display	Malfunction	Reference page
CAN COMM CIRC [U1000]	Malfunction is detected in CAN communication. <b>CAUTION:</b> Even when there is no malfunction on CAN communication system, malfunction may be misinterpreted when battery has low voltage (when maintaining 7 - 8 V for about 2 seconds) or 10A fuse [No. 19, located in the fuse block (J/B)] is disconnected.	<a href="#">MWI-18</a>
VEHICLE SPEED CIRC [B2205]	Malfunction is detected when an erroneous speed signal is input. <b>CAUTION:</b> Even when there is no malfunction on speed signal system, malfunction may be misinterpreted when battery has low voltage (when maintaining 7 - 8 V for about 2 seconds).	<a href="#">MWI-19</a>

### NOTE:

"TIME" indicates the following.

- 0: Indicates that a malfunction is detected at present.
- 1-63: Indicates that a malfunction was detected in the past. (Displays number of ignition switch OFF → ON cycles after malfunction is detected. Self-diagnosis result is erased when "63" is exceeded.)

# THE ODO/TRIP METER DOES NOT FUNCTION

< SYMPTOM DIAGNOSIS >

---

## SYMPTOM DIAGNOSIS

### THE ODO/TRIP METER DOES NOT FUNCTION

Description

INFOID:000000001503736

Refer to [MWI-9, "ODO/TRIP METER : System Description"](#).

Diagnosis Procedure

INFOID:000000001503737

#### 1. CHECK SPEEDOMETER OPERATION

---

Drive vehicle and observe operation of speedometer.

Does speedometer operate properly?

YES >> Replace combination meter. Refer to [MWI-63, "Removal and Installation"](#).

NO >> Refer to [MWI-19, "Diagnosis Procedure"](#).



# THE FUEL GAUGE POINTER DOES NOT MOVE

< SYMPTOM DIAGNOSIS >

## THE FUEL GAUGE POINTER DOES NOT MOVE

### Description

INFOID:000000001503738

Refer to [MWI-9, "FUEL GAUGE : System Description"](#).

### Diagnosis Procedure

INFOID:000000001503739

#### 1. CHECK COMBINATION METER INPUT SIGNAL

1. Select "METER/M&A" on CONSULT-III.
2. Using "FUEL METER" of "DATA MONITOR", compare the value of DATA MONITOR with fuel gauge pointer of combination meter.

Fuel gauge pointer	Reference value of data monitor [lit.]
Full	Approx. 68
3/4	Approx. 56
1/2	Approx. 38
1/4	Approx. 22
Empty	Approx. 4

Do CONSULT-III results match chart?

YES >> GO TO 2

NO >> Replace combination meter. Refer to [MWI-63, "Removal and Installation"](#).

#### 2. CHECK HARNESS CONNECTOR

1. Turn ignition switch OFF.
2. Check combination meter and fuel level sensor unit terminals (meter-side and harness-side) for poor connection.

Are connections OK?

YES >> GO TO 3

NO >> Repair or replace terminals or connectors.

#### 3. CHECK FUEL LEVEL SENSOR UNIT CIRCUIT

1. Disconnect combination meter connector and fuel level sensor unit connector.
2. Check continuity between combination meter harness connector (A) and fuel level sensor unit and fuel pump harness connector (B).

A		B		Continuity
Connector	Terminal	Connector	Terminal	
M24	34	B42	2	Yes

3. Check continuity between combination meter harness connector (A) and ground.

A		Ground	Continuity
Connector	Terminal		
M24	34		No

Do test results match charts?

YES >> GO TO 4

NO >> Repair harness or connector.

#### 4. CHECK FUEL LEVEL SENSOR UNIT GROUND CIRCUIT

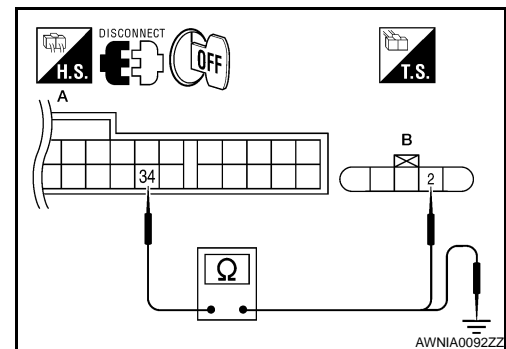

AWNIA0092ZZ

A  
B  
C  
D  
E  
F  
G  
H  
I  
J  
K  
L  
M  
N  
O  
P

MWI

# THE FUEL GAUGE POINTER DOES NOT MOVE

## < SYMPTOM DIAGNOSIS >

1. Check continuity between combination meter harness connector (A) and fuel level sensor unit and fuel pump harness connector (B).

A		B		Continuity
Connector	Terminal	Connector	Terminal	
M24	24	B42	5	Yes

2. Check continuity between combination meter harness connector (A) and ground.

A		Ground	Continuity
Connector	Terminal		
M24	24		No

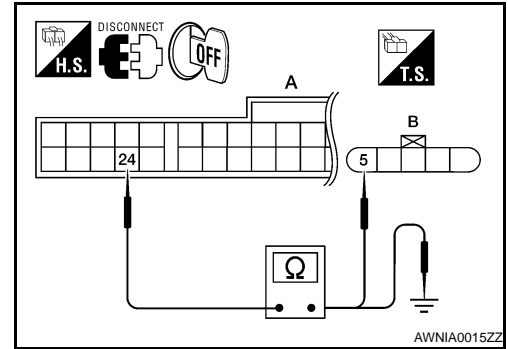

### Do test results match charts?

- YES >> GO TO 5
- NO >> Repair harness or connector.

## 5. CHECK FUEL LEVEL SENSOR UNIT

Check fuel level sensor unit. Refer to [MWI-24, "Component Inspection"](#).

### Is fuel level sensor unit OK?

- YES >> Check fuel level sensor unit installation, and check whether the float arm interferes or binds with any of the internal components in the fuel tank. Repair or replace the malfunctioning part, if necessary.
- NO >> Replace fuel level sensor unit. Refer to [FL-7, "Removal and Installation"](#)

# THE FUEL GAUGE POINTER DOES NOT MOVE TO "F" WHEN REFUELING

< SYMPTOM DIAGNOSIS >

## THE FUEL GAUGE POINTER DOES NOT MOVE TO "F" WHEN REFUELING

### Description

INFOID:000000001503740

Refer to [MWI-9, "FUEL GAUGE : System Description"](#).

### Diagnosis Procedure

INFOID:000000001503741

#### 1.OBSERVE FUEL GAUGE

Does it take a long time for the pointer to move to FULL position?

YES or NO

YES >> GO TO 2

NO >> GO TO 3

#### 2.IDENTIFY FUELING CONDITION

Was the vehicle fueled with the ignition switch ON?

YES or NO

YES >> Be sure to fuel the vehicle with the ignition switch OFF. Otherwise, it will take a long time to move to FULL position because of the characteristic of the fuel gauge.

NO >> GO TO 3

#### 3.OBSERVE VEHICLE POSITION

Is the vehicle parked on an incline?

YES or NO

YES >> Check the fuel level indication with vehicle on a level surface.

NO >> GO TO 4

#### 4.OBSERVE FUEL GAUGE POINTER

During driving, does the fuel gauge pointer move gradually toward EMPTY position?

YES or NO

YES >> Check the components. Refer to [MWI-24, "Component Inspection"](#).

NO >> The float arm may interfere or bind with any of the components in the fuel tank.

A  
B  
C  
D  
E  
F  
G  
H  
I  
J  
K  
L  
M  
O  
P

MWI

# THE OIL PRESSURE SWITCH DOES NOT TURN ON

< SYMPTOM DIAGNOSIS >

## THE OIL PRESSURE SWITCH DOES NOT TURN ON

### Description

INFOID:000000001503742

Refer to [MWI-10, "WARNING LAMPS/INDICATOR LAMPS : System Description"](#).

### Diagnosis Procedure

INFOID:000000001503743

#### 1. CHECK IPDM E/R OUTPUT SIGNAL

Activate IPDM E/R auto active test. Refer to [PCS-10, "Diagnosis Description"](#).

Is oil pressure warning lamp blinking?

- YES >> GO TO 4
- NO >> GO TO 2

#### 2. CHECK SELF-DIAGNOSTIC RESULTS OF IPDM E/R

Select "IPDM E/R" on CONSULT-III, and perform "SELF-DIAGNOSIS" of IPDM E/R. Refer to [PCS-13, "CONSULT - III Function \(IPDM E/R\)"](#).

Self-diagnostic results content

- No malfunction detected >> GO TO 3
- Malfunction detected >> Refer to [PCS-32, "DTC Index"](#).

#### 3. CHECK IPDM E/R INPUT SIGNAL

1. Select "IPDM E/R" on CONSULT-III.
2. Monitor "OIL P SW" of "DATA MONITOR" while operating ignition switch.

##### OIL P SW

**When ignition switch is in ON : CLOSE position (Engine stopped)**

**When engine running : OPEN**

Do results on CONSULT-III match specifications?

- YES >> Replace combination meter. Refer to [MWI-63, "Removal and Installation"](#).
- NO >> Replace IPDM E/R. Refer to [PCS-34, "Removal and Installation"](#).

#### 4. CHECK OIL PRESSURE SWITCH CIRCUIT

1. Turn ignition switch OFF.
2. Disconnect IPDM E/R connector and oil pressure switch connector.
3. Check continuity between IPDM E/R harness connector F10 (A) terminal 75 and oil pressure switch harness connector F41 (B) terminal 1.

**Continuity should exist.**

Does continuity exist?

- YES >> GO TO 5
- NO >> Repair harness or connector.

#### 5. CHECK OIL PRESSURE SWITCH

Check oil pressure switch. Refer to [MWI-25, "Component Inspection"](#).

Is the oil pressure switch OK?

- YES >> Replace IPDM E/R. Refer to [PCS-34, "Removal and Installation"](#).
- NO >> Replace oil pressure switch.

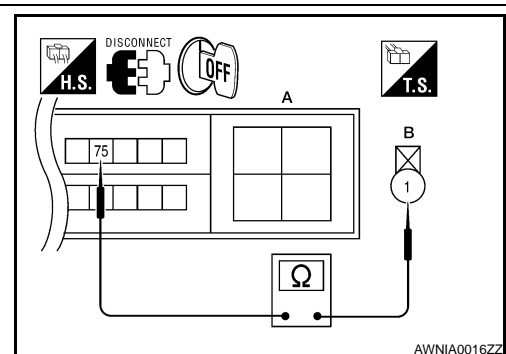

# THE OIL PRESSURE SWITCH DOES NOT TURN OFF

< SYMPTOM DIAGNOSIS >

## THE OIL PRESSURE SWITCH DOES NOT TURN OFF

### Description

INFOID:000000001503744

Refer to [MWI-10. "WARNING LAMPS/INDICATOR LAMPS : System Description"](#).

### Diagnosis Procedure

INFOID:000000001503745

#### 1. CHECK OIL PRESSURE SWITCH CIRCUIT

1. Turn ignition switch OFF.
2. Disconnect IPDM E/R connector and oil pressure switch connector.
3. Check continuity between IPDM E/R harness connector F10 terminal 75 and ground.

**Continuity should not exist.**

#### Does continuity exist?

- YES >> Repair harness or connector.  
NO >> GO TO 2

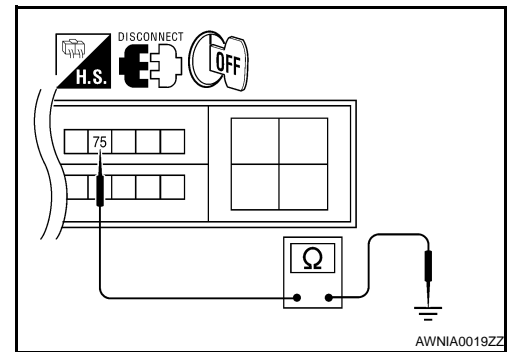

#### 2. CHECK OIL PRESSURE SWITCH

Check oil pressure switch. Refer to [MWI-25. "Component Inspection"](#).

#### Is the oil pressure switch OK?

- YES >> Replace IPDM E/R. Refer to [PCS-34. "Removal and Installation"](#).  
NO >> Replace oil pressure switch.

A  
B  
C  
D  
E  
F  
G  
H  
I  
J  
K  
L  
M  
O  
P

MWI

# THE PARKING BRAKE RELEASE WARNING CONTINUES DISPLAYING, OR DOES NOT DISPLAY

< SYMPTOM DIAGNOSIS >

---

## THE PARKING BRAKE RELEASE WARNING CONTINUES DISPLAYING, OR DOES NOT DISPLAY

### Description

INFOID:000000001503746

Refer to [MWI-11, "INFORMATION DISPLAY : System Description"](#).

### Diagnosis Procedure

INFOID:000000001503747

#### 1. CHECK COMBINATION METER INPUT SIGNAL

---

1. Select "METER/M&A" on CONSULT-III.
2. Monitor "PKB SW" of "DATA MONITOR" while applying and releasing the parking brake.

#### PKB SW

**Parking brake applied : ON**

**Parking brake released : OFF**

Do CONSULT-III results match specifications?

- YES >> GO TO 2  
NO >> Refer to [MWI-26, "Diagnosis Procedure"](#).

#### 2. CHECK SPEEDOMETER OPERATION

---

Drive vehicle and observe operation of speedometer.

Does speedometer operate properly?

- YES >> Replace combination meter. Refer to [MWI-63, "Removal and Installation"](#).  
NO >> Refer to [MWI-19, "Diagnosis Procedure"](#).

# THE LOW WASHER FLUID WARNING CONTINUES DISPLAYING, OR DOES NOT DISPLAY

< SYMPTOM DIAGNOSIS >

## THE LOW WASHER FLUID WARNING CONTINUES DISPLAYING, OR DOES NOT DISPLAY

### Description

INFOID:000000001503748

Refer to [MWI-11, "INFORMATION DISPLAY : System Description"](#).

### Diagnosis Procedure

INFOID:000000001503749

#### 1. CHECK COMBINATION METER INPUT SIGNAL

1. Select "METER/M&A" on CONSULT-III.
2. Monitor "WASHER W/L" of "DATA MONITOR" under the following conditions.

#### WASHER W/L

Washer fluid level low : ON

Washer fluid level other : OFF

Does CONSULT-III match specifications?

- YES >> Replace combination meter. Refer to [MWI-63, "Removal and Installation"](#).  
NO >> GO TO 2

#### 2. CHECK WASHER LEVEL SWITCH CIRCUIT

1. Disconnect combination meter connector and washer level switch connector.
2. Check continuity between combination meter harness connector M24 (A) terminal 29 and washer level switch harness connector E208 (B) terminal 1.

**29 - 1 : Continuity should exist.**

3. Check continuity between combination meter harness connector M24 (A) terminal 29 and ground.

**29 - Ground : Continuity should not exist.**

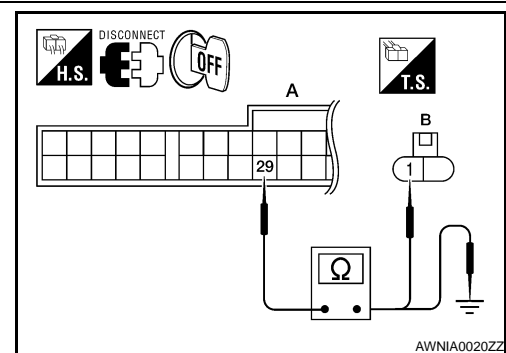

Do test results match specifications?

- YES >> GO TO 3  
NO >> Repair harness or connector.

#### 3. CHECK WASHER LEVEL SWITCH GROUND CIRCUIT

Check continuity between washer level switch harness connector E208 terminal 2 and ground.

**2 - Ground : Continuity should exist.**

Does continuity exist?

- YES >> Replace washer level switch.  
NO >> Repair harness or connector.

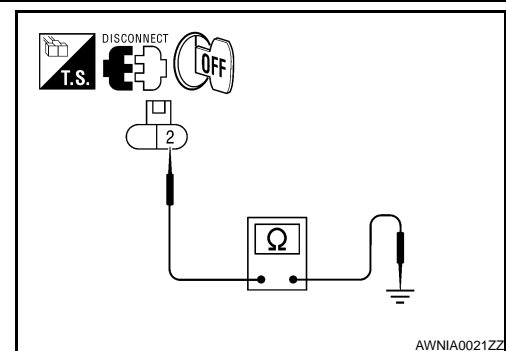

A  
B  
C  
D  
E  
F  
G  
H  
I  
J  
K  
L  
M  
N  
O  
P

MWI

# THE DOOR OPEN WARNING CONTINUES DISPLAYING, OR DOES NOT DISPLAY

< SYMPTOM DIAGNOSIS >

## THE DOOR OPEN WARNING CONTINUES DISPLAYING, OR DOES NOT DISPLAY

### Description

INFOID:000000001503750

Refer to [MWI-11, "INFORMATION DISPLAY : System Description"](#).

### Diagnosis Procedure

INFOID:000000001503751

#### 1. CHECK COMBINATION METER INPUT SIGNAL

1. Select "METER/M&A" on CONSULT-III.
2. Monitor "DOOR W/L" of "DATA MONITOR" while opening and closing doors.

##### DOOR W/L

Front door LH open	: ON
Front door LH closed	: OFF
Front door RH open	: ON
Front door RH closed	: OFF
Rear door LH open	: ON
Rear door LH closed	: OFF
Rear door RH open	: ON
Rear door RH closed	: OFF

Does CONSULT-III match specifications?

YES >> GO TO 2  
NO >> GO TO 3

#### 2. CHECK COMBINATION METER INPUT SIGNAL

1. Select "METER/M&A" on CONSULT-III.
2. Monitor "TRUNK/GLAS-H" of "DATA MONITOR" while opening and closing trunk.

##### TRUNK/GLAS-H

Trunk open	: ON
Trunk closed	: OFF

Does CONSULT-III match specifications?

YES >> Replace combination meter. Refer to [MWI-63, "Removal and Installation"](#).  
NO >> GO TO 4

#### 3. CHECK BCM INPUT SIGNAL

1. Select "BCM" on CONSULT-III.
2. Monitor "DOOR SW DR", "DOOR SW AS", "DOOR SW RL" and "DOOR SW RR" of "DATA MONITOR" while opening and closing doors.

##### When doors are open

DOOR SW DR	: ON
DOOR SW AS	: ON
DOOR SW RL	: ON
DOOR SW RR	: ON

##### When doors are closed

DOOR SW DR	: OFF
DOOR SW AS	: OFF



# THE DOOR OPEN WARNING CONTINUES DISPLAYING, OR DOES NOT DISPLAY

## < SYMPTOM DIAGNOSIS >

**DOOR SW RL : OFF**  
**DOOR SW RR : OFF**

Does CONSULT-III match specifications?

- YES >> Replace BCM. Refer to [BCS-78, "Removal and Installation"](#).  
NO >> GO TO 5

### 4.CHECK BCM INPUT SIGNAL

1. Select "BCM" on CONSULT-III.
2. Monitor "TRUNK SW" of "DATA MONITOR" while opening and closing trunk.

**When trunk is open**  
**TRUNK SW : ON**

**When trunk is closed**  
**TRUNK SW : OFF**

Does CONSULT-III match specifications?

- YES >> Replace BCM. Refer to [BCS-78, "Removal and Installation"](#).  
NO >> GO TO 6

### 5.CHECK DOOR SWITCHES

1. Disconnect door switches.
2. Check continuity between door switch (front LH), (front RH), (rear LH) and (rear RH) terminal 2 and exposed metal of switch while pressing and releasing switch.

**When door switch is released** : Continuity should exist

**When door switch is pushed** : Continuity should not exist

Do test results match specifications?

- YES >> Repair open or short in circuit between BCM and door switch.  
NO >> Replace door switch.

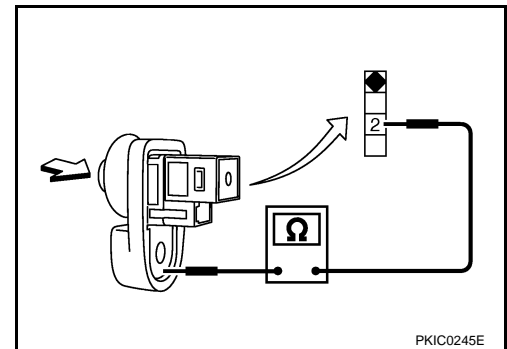

### 6.CHECK TRUNK LAMP SWITCH AND RELEASE SOLENOID

1. Disconnect trunk lamp switch and release solenoid.
2. Check continuity between trunk lamp switch and release solenoid terminals 1 and 2.

**When trunk is open** : Continuity should exist

**When trunk is closed** : Continuity should not exist

Do test results match specifications?

- YES >> GO TO 7  
NO >> Replace trunk lamp switch and release solenoid.

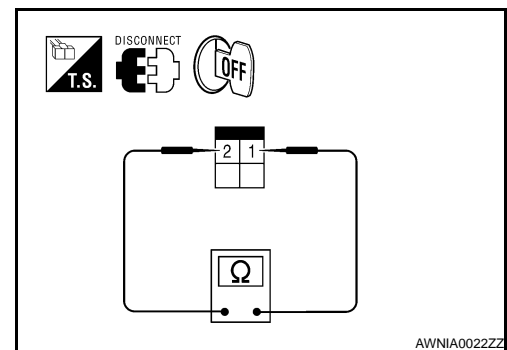

### 7.CHECK TRUNK LAMP SWITCH AND RELEASE SOLENOID GROUND CIRCUIT

# THE DOOR OPEN WARNING CONTINUES DISPLAYING, OR DOES NOT DISPLAY

## < SYMPTOM DIAGNOSIS >

Check continuity between trunk lamp switch and release solenoid connector B28 terminal 2 and ground.

**Continuity should exist.**

### Does continuity exist?

- YES >> Repair open or short in circuit between BCM and trunk lamp switch and release solenoid.
- NO >> Repair harness or connector.

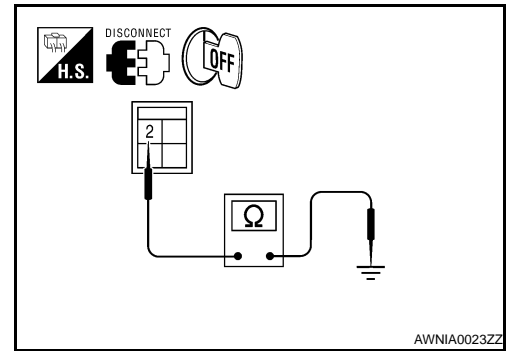

# THE AMBIENT TEMPERATURE DISPLAY IS INCORRECT

< SYMPTOM DIAGNOSIS >

## THE AMBIENT TEMPERATURE DISPLAY IS INCORRECT

### Description

INFOID:000000001503752

Refer to [MWI-11, "INFORMATION DISPLAY : System Description"](#).

### Diagnosis Procedure

INFOID:000000001503753

#### 1. CHECK COMBINATION METER INPUT SIGNAL

1. Select "METER/M&A" on CONSULT-III.
2. Using "OUTSIDE TEMP" on "DATA MONITOR", compare the value of DATA MONITOR with temperature display on combination meter.

Is DATA MONITOR indication close to combination meter?

YES >> GO TO 2

NO >> Replace combination meter. Refer to [MWI-63, "Removal and Installation"](#).

#### 2. CHECK AMBIENT SENSOR CIRCUITS BETWEEN COMBINATION METER AND IPDM E/R

1. Disconnect combination meter connector M24 and IPDM E/R connector E18.
2. Check continuity between combination meter harness connector M24 (A) terminals 18, 20 and IPDM E/R harness connector E18 (B) terminals 20 and 21.

A		B		Continuity
Connector	Terminal	Connector	Terminal	
M24	18	E18	21	Yes
	20		20	

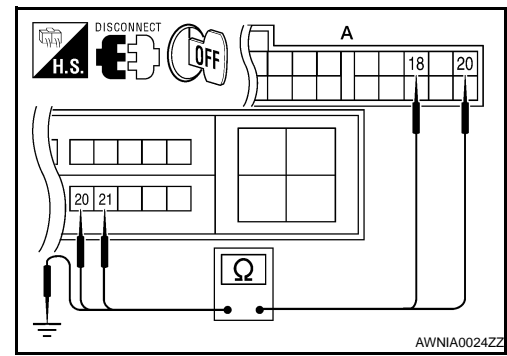

3. Check continuity between combination meter harness connector M24 (A) terminals 18, 20 and ground.

A		Ground	Continuity
Connector	Terminal		
M24	18		No
	20		

Do test results match charts?

YES >> GO TO 3

NO >> Repair harness or connector.

#### 3. CHECK AMBIENT SENSOR CIRCUITS BETWEEN IPDM E/R AND AMBIENT SENSOR

1. Disconnect IPDM E/R connector E201 and ambient sensor connector E211.
2. Check continuity between IPDM E/R harness connector E201 (A) terminals 99, 100 and ambient sensor harness connector E211 terminals 1 and 2.

A		B		Continuity
Connector	Terminal	Connector	Terminal	
E201	99	E211	2	Yes
	100		1	

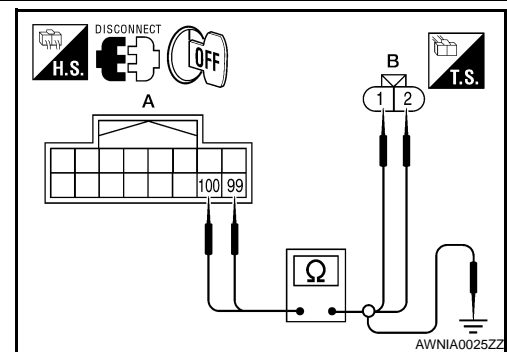

3. Check continuity between IPDM E/R harness connector E201 (A) terminals 99, 100 and ground.

A  
B  
C  
D  
E  
F  
G  
H  
I  
J  
K  
L  
M  
N  
O  
P

# THE AMBIENT TEMPERATURE DISPLAY IS INCORRECT

## < SYMPTOM DIAGNOSIS >

A		Ground	Continuity
Connector	Terminal		
E201	99		No
	100		

Do test results match charts?

YES >> GO TO 4

NO >> Repair harness or connector.

### 4. CHECK AMBIENT SENSOR

Check the resistance between ambient sensor terminals 1 and 2.

Temperature °C (°F)	Resistance kΩ
-15 (5)	12.73
-10 (14)	9.92
-5 (23)	7.80
0 (32)	6.19
5 (41)	4.95
10 (50)	3.99
15 (59)	3.24
20 (68)	2.65
25 (77)	2.19
30 (86)	1.81
35 (95)	1.51
40 (104)	1.27
45 (113)	1.07

Does test value come close to chart?

YES >> Replace IPDM E/R. Refer to [PCS-34. "Removal and Installation"](#).

NO >> Replace ambient sensor.

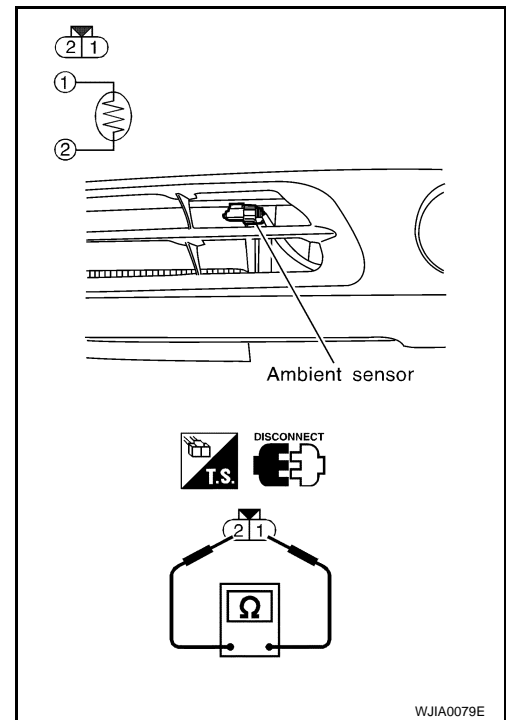

WJIA0079E

# NORMAL OPERATING CONDITION

< SYMPTOM DIAGNOSIS >

## NORMAL OPERATING CONDITION COMPASS

### COMPASS : Description

INFOID:000000001503754

#### COMPASS

- The electronic compass is highly protected from changes in most magnetic fields. However, some large changes in magnetic fields can affect it. Some examples are (but not limited to): high tension power lines, large steel buildings, subways, steel bridges, automatic car washes, large piles of scrap metal, etc. While this does not happen very often, it is possible.
- During normal operation, the Compass Mirror will continuously update the compass calibration to adjust for gradual changes in the vehicle's magnetic "remnant" field. If the vehicle is subjected to high magnetic influences, the compass may appear to indicate false headings, become locked, or appear that it is unable to be calibrated. If this occurs, perform the calibration procedure.
- If at any time the compass continually displays the incorrect direction or the reading is erratic or locked, verify the correct zone variance.

#### Symptom Chart

Symptom	Cause	Solution / Reference
The compass display reads "C".	<ul style="list-style-type: none"> <li>• Compass is not calibrated.</li> <li>• Incorrect zone variance setting.</li> <li>• Large change in magnetic field (Steel bridges, subways, concentrations of metal, car washes, etc.)</li> <li>• Compass was calibrated incorrectly or in the presence of a strong magnetic field.</li> </ul>	Perform Calibration. Refer to <a href="#">MWI-13, "Description"</a> .
Compass shows the wrong direction.		
Compass does not change direction appears "Locked".		
Compass does not show all the directions, one or more is missing.		
The compass was calibrated but it "loses" calibration.		Perform Zone Variation Setting if correct reading is desired in that location. Refer to <a href="#">MWI-13, "Description"</a> .
On long trips the compass shows the wrong direction.		

A  
B  
C  
D  
E  
F  
G  
H  
I  
J  
K  
L  
M  
O  
P

MWI

# PRECAUTIONS

< PRECAUTION >

---

## PRECAUTION

### PRECAUTIONS

#### Supplemental Restraint System (SRS) "AIR BAG" and "SEAT BELT PRE-TENSIONER"

INFOID:000000001503755

The Supplemental Restraint System such as "AIR BAG" and "SEAT BELT PRE-TENSIONER", used along with a front seat belt, helps to reduce the risk or severity of injury to the driver and front passenger for certain types of collision. This system includes seat belt switch inputs and dual stage front air bag modules. The SRS system uses the seat belt switches to determine the front air bag deployment, and may only deploy one front air bag, depending on the severity of a collision and whether the front occupants are belted or unbelted. Information necessary to service the system safely is included in the SRS and SB section of this Service Manual.

**WARNING:**

- To avoid rendering the SRS inoperative, which could increase the risk of personal injury or death in the event of a collision which would result in air bag inflation, all maintenance must be performed by an authorized NISSAN/INFINITI dealer.
- Improper maintenance, including incorrect removal and installation of the SRS, can lead to personal injury caused by unintentional activation of the system. For removal of Spiral Cable and Air Bag Module, see the SRS section.
- Do not use electrical test equipment on any circuit related to the SRS unless instructed to in this Service Manual. SRS wiring harnesses can be identified by yellow and/or orange harnesses or harness connectors.

# COMBINATION METER

< ON-VEHICLE REPAIR >

## ON-VEHICLE REPAIR

### COMBINATION METER

#### Removal and Installation

INFOID:000000001503756

#### REMOVAL

1. Disconnect the 12-volt battery negative terminal.
2. Remove the instrument side mask (LH).
3. Open the fuse block cover, remove the instrument lower cover (LH) screw (A), using power tools then remove the instrument lower cover (LH) (1).
  - Disconnect the following harness connectors:
    - In-vehicle sensor
    - VDC switch
    - Trunk lid release switch
    - Disconnect the aspirator tube.

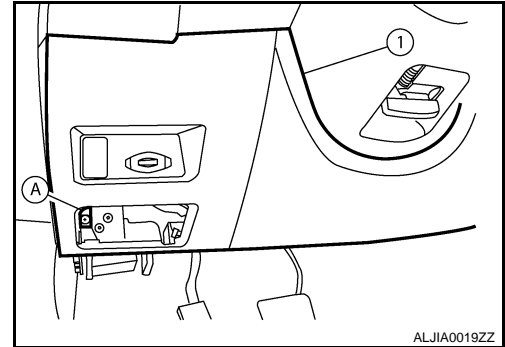

4. Remove the steering column upper and lower cover screws (A), then remove both the steering column upper (1) and lower (2) covers.

**NOTE:**

Steering wheel not shown for clarity. Turn steering wheel to access steering column cover screws.

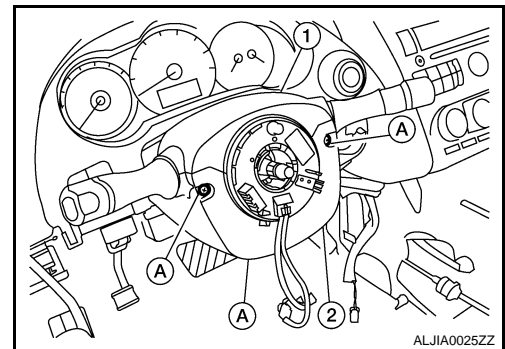

5. Remove the cluster lid A (1).

**NOTE:**

Steering wheel not shown for clarity.

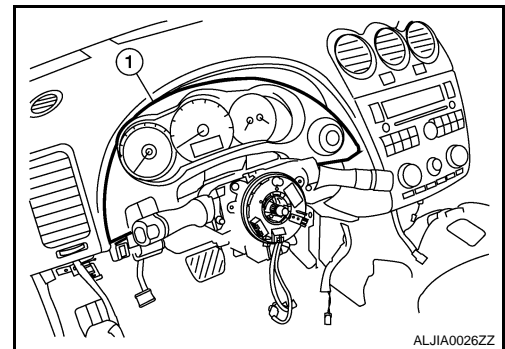

6. Remove the combination meter screws (A) using power tools, and pull out the combination meter (1).
7. Disconnect the combination meter connector, and remove the combination meter (1).

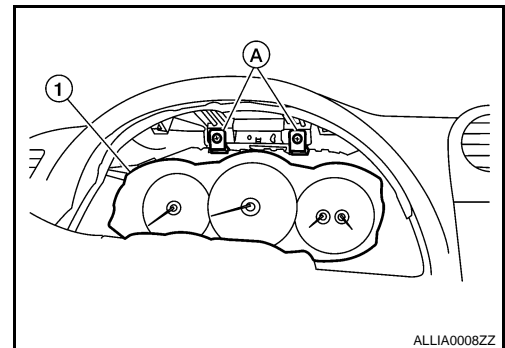

#### INSTALLATION

A  
B  
C  
D  
E  
F  
G  
H  
I  
J  
K  
L  
M  
MWI  
O  
P

## COMBINATION METER

< ON-VEHICLE REPAIR >

Installation is the reverse order of removal.

---



# COMBINATION METER

< DISASSEMBLY AND ASSEMBLY >

## DISASSEMBLY AND ASSEMBLY

### COMBINATION METER

#### Disassembly and Assembly

INFOID:000000001503757

#### DISASSEMBLY

1. Remove the combination meter. Refer to [IP-11. "Removal and Installation"](#).
2. Remove the combination meter lens (1) from the combination meter (2).

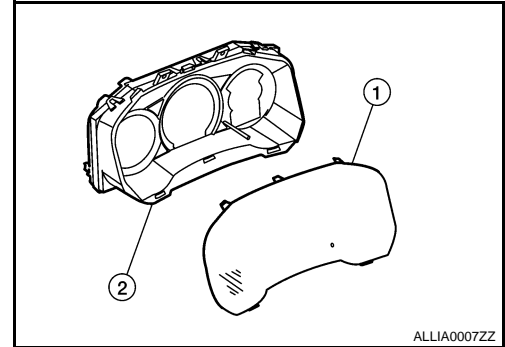

#### ASSEMBLY

Assembly is in the reverse order of removal.

A  
B  
C  
D  
E  
F  
G  
H  
I  
J  
K  
L  
M  
O  
P

MWI