

RF
SECTION
ROOF

A
 B
 C
 D
 E
 F
 G
 H
 I
 J
 L
 M
 N
 O
 P

CONTENTS

BASIC INSPECTION	3	SUNROOF MOTOR ASSEMBLY :	
DIAGNOSIS AND REPAIR WORKFLOW	3	Component Function Check	11
Work Flow	3	SUNROOF MOTOR ASSEMBLY :	
INSPECTION AND ADJUSTMENT	6	Diagnosis Procedure	11
ADDITIONAL SERVICE WHEN REPLACING		SUNROOF MOTOR ASSEMBLY : Component In-	
CONTROL UNIT	6	spection	14
ADDITIONAL SERVICE WHEN REPLACING		SUNROOF MOTOR ASSEMBLY : Special Repair	
CONTROL UNIT : Description	6	Requirement	14
ADDITIONAL SERVICE WHEN REPLACING		DOOR SWITCH	15
CONTROL UNIT : Special Repair Requirement	6	Description	15
BASIC INSPECTION	6	Component Function Check	15
BASIC INSPECTION : Special Repair Require-		Diagnosis Procedure	15
ment	6	Component Inspection	17
FUNCTION DIAGNOSIS	8	ECU DIAGNOSIS	19
SUNROOF SYSTEM	8	BCM (BODY CONTROL MODULE)	19
System Diagram	8	Reference Value	19
System Description	8	Terminal Layout	23
Component Parts Location	9	Physical Values	24
Component Description	9	SUNROOF MOTOR ASSEMBLY	42
DIAGNOSIS SYSTEM (BCM)	10	Reference Value	42
COMMON ITEM	10	Wiring Diagram	43
COMMON ITEM : CONSULT-III Function (BCM -		SYMPTOM DIAGNOSIS	47
COMMON ITEM)	10	SUNROOF DOES NOT OPERATE PROPER-	
RETAINED PWR	10	LY	47
RETAINED PWR : CONSULT-III Function (BCM -		Diagnosis Procedure	47
RETAINED PWR)	10	AUTO OPERATION DOES NOT OPERATE	48
COMPONENT DIAGNOSIS	11	Diagnosis Procedure	48
POWER SUPPLY AND GROUND CIRCUIT	11	DOES NOT STOP FULLY-OPEN OR FULLY-	
SUNROOF MOTOR ASSEMBLY	11	CLOSED POSITION	49
SUNROOF MOTOR ASSEMBLY : Description	11	Diagnosis Procedure	49
		RETAINED POWER OPERATION DOES NOT	
		OPERATE PROPERLY	50
		Diagnosis Procedure	50

SUNROOF DOES NOT OPERATE ANTI-PINCH FUNCTION	51	Precautions	58
Diagnosis Procedure	51	PREPARATION	59
SQUEAK AND RATTLE TROUBLE DIAGNOSES	52	PREPARATION	59
Work Flow	52	Special Service Tools	59
Inspection Procedure	54	Commercial Service Tools	59
Diagnostic Worksheet	56	ON-VEHICLE REPAIR	60
PRECAUTION	58	SUNROOF UNIT ASSEMBLY	60
PRECAUTIONS	58	Inspection	60
Supplemental Restraint System (SRS) "AIR BAG" and "SEAT BELT PRE-TENSIONER"	58	Exploded View	64
		Removal and Installation	64

DIAGNOSIS AND REPAIR WORKFLOW

< BASIC INSPECTION >

BASIC INSPECTION

DIAGNOSIS AND REPAIR WORKFLOW

Work Flow

INFOID:000000003071474

OVERALL SEQUENCE

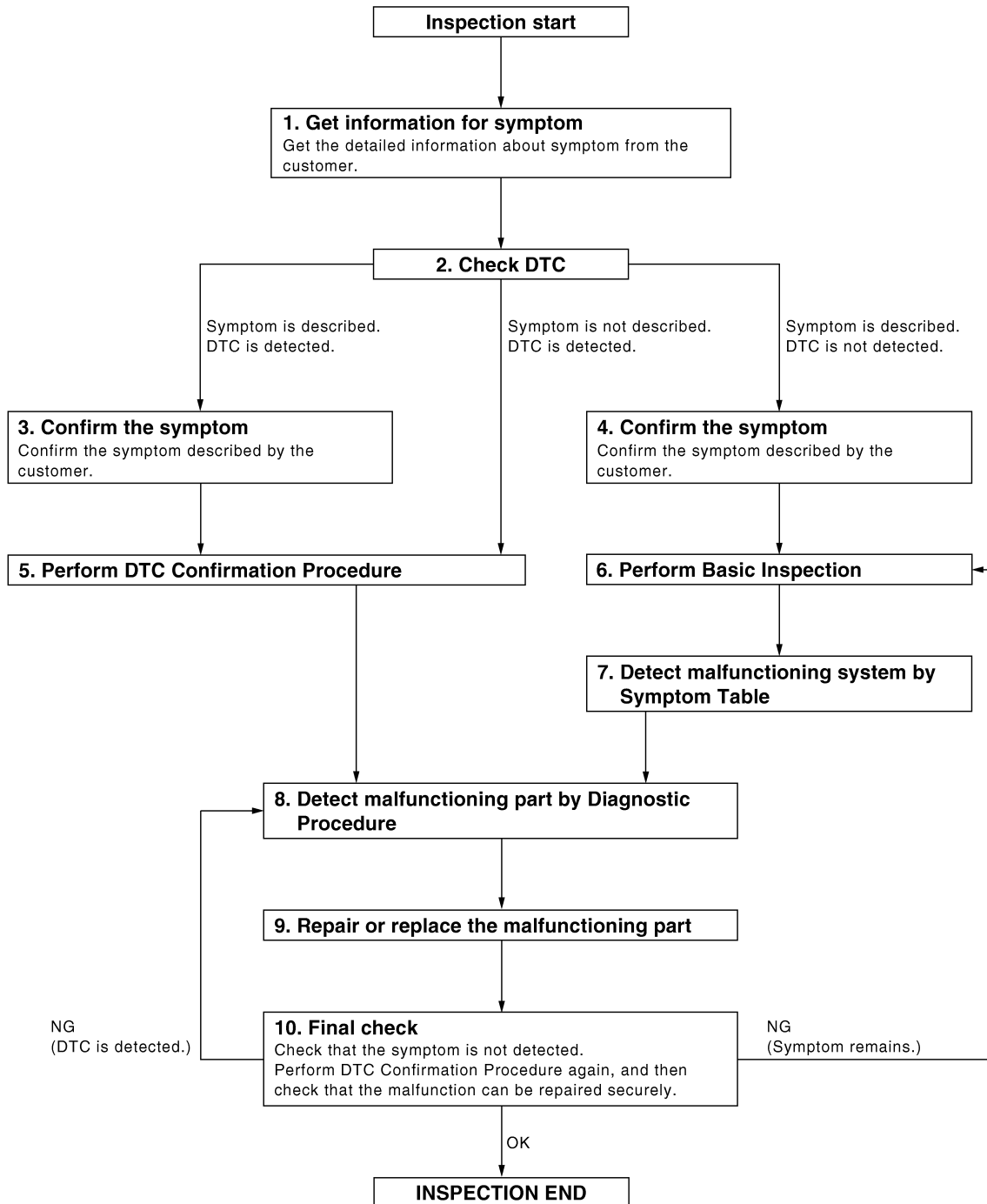

DETAILED FLOW

DIAGNOSIS AND REPAIR WORKFLOW

< BASIC INSPECTION >

1. GET INFORMATION FOR SYMPTOM

Get the detailed information from the customer about the symptom (the condition and the environment when the incident/malfunction occurred).

>> GO TO 2

2. CHECK DTC

1. Check DTC.
2. Perform the following procedure if DTC is displayed.
 - Record DTC and freeze frame data (Print them out with CONSULT-III.)
 - Erase DTC.
 - Study the relationship between the cause detected by DTC and the symptom described by the customer.
3. Check related service bulletins for information.

Is any symptom described and any DTC detected?

Symptom is described, DTC is displayed>>GO TO 3

Symptom is described, DTC is not displayed>>GO TO 4

Symptom is not described, DTC is displayed>>GO TO 5

3. CONFIRM THE SYMPTOM

Confirm the symptom described by the customer.

Connect CONSULT-III to the vehicle in "DATA MONITOR" mode and check real time diagnosis results.

Verify relation between the symptom and the condition when the symptom is detected.

>> GO TO 5

4. CONFIRM THE SYMPTOM

Confirm the symptom described by the customer.

Connect CONSULT-III to the vehicle in "DATA MONITOR" mode and check real time diagnosis results.

Verify relation between the symptom and the condition when the symptom is detected.

>> GO TO 6

5. PERFORM DTC CONFIRMATION PROCEDURE

Perform DTC Confirmation Procedure for the displayed DTC, and then check that DTC is detected again.

At this time, always connect CONSULT-III to the vehicle, and check diagnostic results in real time.

If two or more DTCs are detected, refer to [BCS-79. "DTC Inspection Priority Chart"](#) and determine trouble diagnosis order.

NOTE:

- Freeze frame data is useful if the DTC is not detected.
- Perform Component Function Check if DTC Confirmation Procedure is not included in Service Manual. This simplified check procedure is an effective alternative though DTC cannot be detected during this check. If the result of Component Function Check is NG, it is the same as the detection of DTC by DTC Confirmation Procedure.

Is DTC detected?

YES >> GO TO 8

NO >> Refer to [GI-42. "Intermittent Incident"](#).

6. PERFORM BASIC INSPECTION

Perform [RF-6. "BASIC INSPECTION : Special Repair Requirement"](#).

Inspection End>>GO TO 7

7. DETECT MALFUNCTIONING SYSTEM BY SYMPTOM DIAGNOSIS

Detect malfunctioning system according to symptom diagnosis based on the confirmed symptom in step 4, and determine the trouble diagnosis order based on possible causes and symptom.

>> GO TO 8

DIAGNOSIS AND REPAIR WORKFLOW

< BASIC INSPECTION >

8. DETECT MALFUNCTIONING PART BY DIAGNOSTIC PROCEDURE

Inspect according to Diagnostic Procedure of the system.

NOTE:

The Diagnostic Procedure described based on open circuit inspection. A short circuit inspection is also required for the circuit check in the Diagnostic Procedure.

Is malfunctioning part detected?

YES >> GO TO 9

NO >> Check voltage of related BCM terminals using CONSULT-III.

9. REPAIR OR REPLACE THE MALFUNCTIONING PART

1. Repair or replace the malfunctioning part.
2. Reconnect parts or connectors disconnected during Diagnostic Procedure again after repair and replacement.
3. Check DTC. If DTC is displayed, erase it.

>> GO TO 10

10. FINAL CHECK

When DTC was detected in step 2, perform DTC Confirmation Procedure or Component Function Check again, and then check that the malfunction have been repaired securely.

When symptom was described from the customer, refer to confirmed symptom in step 3 or 4, and check that the symptom is not detected.

Does the symptom reappear?

YES (DTC is detected)>>GO TO 8

YES (Symptom remains)>>GO TO 6

NO >> Inspection End.

A
B
C
D
E
F
G
H
I
J
L
M
N
O
P

RF

INSPECTION AND ADJUSTMENT

< BASIC INSPECTION >

INSPECTION AND ADJUSTMENT

ADDITIONAL SERVICE WHEN REPLACING CONTROL UNIT

ADDITIONAL SERVICE WHEN REPLACING CONTROL UNIT : Description

INFOID:000000003071475

MEMORY RESET PROCEDURE

1. Please observe the following instructions at confirming the sunroof operation.

NOTE:

Do not disconnect the electronic power while the sunroof is operating or within 5 seconds after the sunroof stops. (to wipe-out the memory of lid position and operating friction.)

2. Initialization of system should be conducted after the following conditions.
 - When the sunroof motor is changed.
 - When the sunroof does not operate normally. (Incomplete initialization conditions)

ADDITIONAL SERVICE WHEN REPLACING CONTROL UNIT : Special Repair Requirement

INFOID:000000003229660

INITIALIZATION PROCEDURE

If the sunroof does not open or close automatically, use the following procedure to return sunroof operation to normal.

NOTE:

If the sunroof switch is released at any time during step 4, the procedure must be started over again. Leave the ignition switch ON for at least 2 seconds after this procedure.

1. Push the ignition switch to the ON position.
2. Hold the sunroof switch in the tilt up position. Release the switch when the sunroof has reached the full tilt up position.
3. Hold the sunroof switch in the tilt up position again. After a delay, the sunroof will backup. Release the switch.
4. Within 5 seconds of releasing the switch in step 3, hold the sunroof switch in the tilt up position again. The sunroof will move from the full tilt up position, to the open position and back to the close position. Release the switch only when the sunroof has reached the full closed position.

ANTI-PINCH FUNCTION

1. Full open the sunroof.
2. Place a piece of wood near fully closed position.
3. Close the sunroof completely with auto-slide close.

Check that sunroof lowers for approximately 150mm (5.91 in) or 2 seconds with out pinching a piece of wood and stops.

CAUTION:

- Do not check with hands and other part of body because they may be pinched. Do not get pinched.
- Depending on environment and driving conditions, if a similar impact or load is applied to the sunroof it may lower.
- Check that auto-slide operates before inspection when system initialization is performed.
- Perform initial setting when auto-slide operation or anti-pinch function does not operate normally.

BASIC INSPECTION

BASIC INSPECTION : Special Repair Requirement

INFOID:000000003071477

BASIC INSPECTION

1.INSPECTION START

-
1. Check the service history.
 2. Check the following parts.
 - Fuse/circuit breaker blown.
 - Poor connection, open or short circuit of harness connector.

INSPECTION AND ADJUSTMENT

< BASIC INSPECTION >

- Battery voltage.

Is the inspection result normal?

YES >> Inspection End.

NO >> Repair or replace the malfunctioning parts.

A

B

C

D

E

F

G

H

I

J

RF

L

M

N

O

P

SUNROOF SYSTEM

< FUNCTION DIAGNOSIS >

FUNCTION DIAGNOSIS

SUNROOF SYSTEM

System Diagram

INFOID:000000003071478

SUNROOF

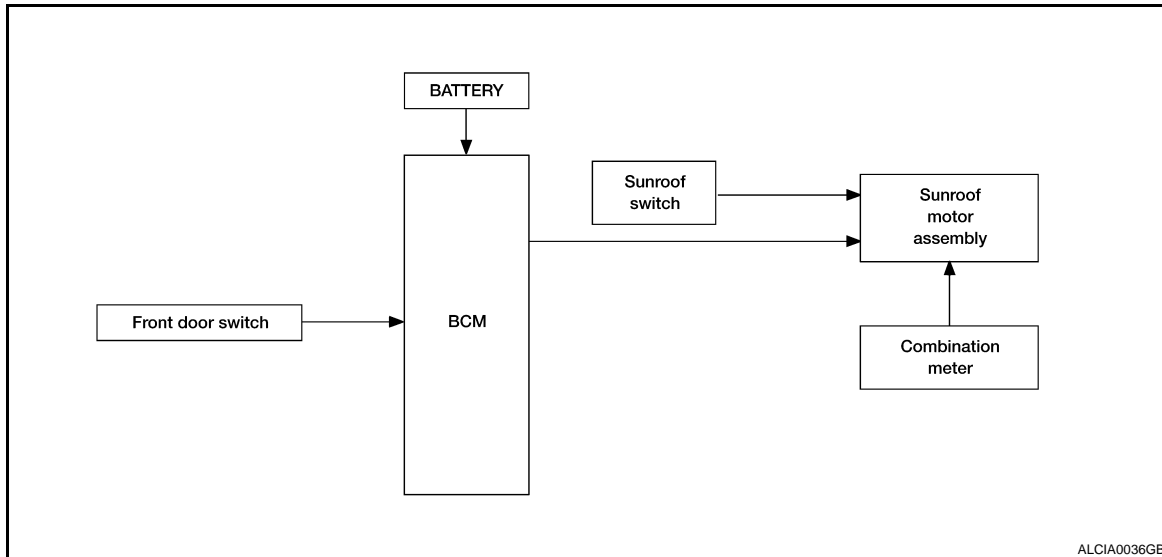

ALCIA0036GB

System Description

INFOID:000000003071479

SUNROOF SYSTEM

INPUT/OUTPUT SIGNAL CHART

Item	Input signal to sunroof motor assembly	Sunroof motor function	Actuator
Sunroof switch	Sunroof switch signal (tilt down or slide open)	Sunroof control	Sunroof motor
	Sunroof switch signal (tilt up or slide close)		
Combination meter	Vehicle speed signal		
BCM	RAP signal		

SUNROOF OPERATION

- Sunroof motor assembly operates with the power supply that is output from BCM while ignition switch is ON or retained power is operating.
- Tilt up/down & slide open/close signals from sunroof switch enables operate sunroof motor to move arbitrarily.
- Sunroof motor assembly receives a vehicle speed signal from combination meter and controls the sunroof motor torque of tilt-down at the time of high speed operation.

AUTO OPERATION

Sunroof AUTO feature makes it possible to slide open and slide close or tilt up and tilt down the sunroof without holding the sunroof switch in the slide open/tilt down or slide close/tilt up position.

RETAINED POWER OPERATION

- Retained power operation is an additional power supply function that enables sunroof system to operate during the 45 seconds even when ignition switch is turned OFF.

Retained power function cancel conditions

- Front door CLOSE (door switch OFF)→OPEN (door switch ON).
- When ignition switch is ON again.
- When timer time passes. (45 seconds)

SUNROOF SYSTEM

< FUNCTION DIAGNOSIS >

Component Parts Location

INFOID:000000003071480

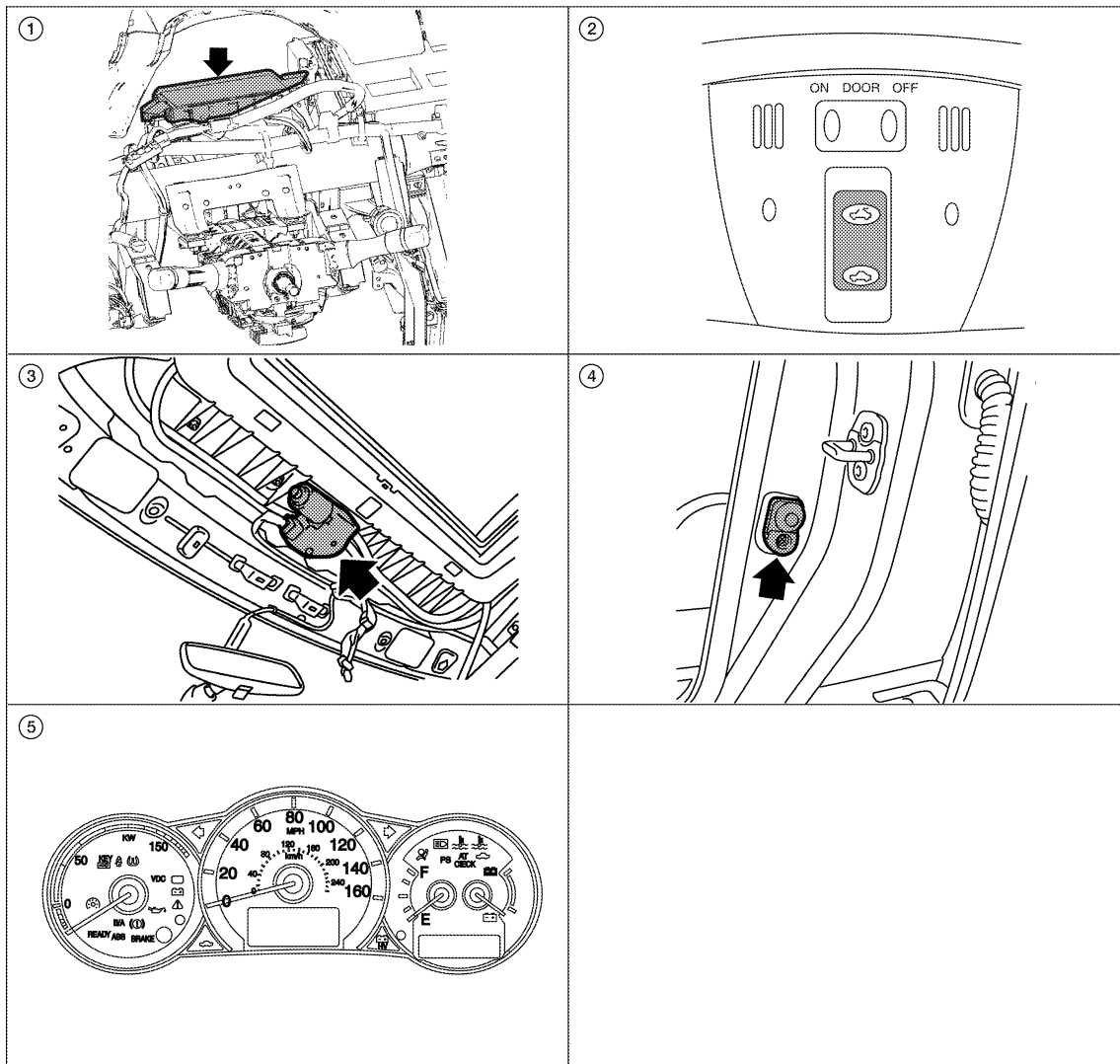

A
B
C
D
E
F
G
H
I
J

RF

ALKIA0258ZZ

L
M

- 1. BCM M16, M17, M18 (View with instrument panel removed)
- 2. Sunroof switch R6
- 3. Sunroof motor assembly R5
- 4. Front door switch LH B8, RH B108
- 5. Combination meter M24

Component Description

INFOID:000000003071481

N
O
P

Component	Function
BCM	Supplies the power supply to sunroof motor assembly.
Sunroof switch	Transmits tilt up/down & slides open/close operation signal to sunroof motor assembly.
Sunroof motor assembly	It is sunroof motor and CPU integrated type that enables tilt up/down & slide open/close by sunroof switch operation
Front door switch	Detects door open/close condition and transmits to BCM.
Combination meter	Transmits vehicle speed signal to sunroof motor assembly.

DIAGNOSIS SYSTEM (BCM)

< FUNCTION DIAGNOSIS >

DIAGNOSIS SYSTEM (BCM)

COMMON ITEM

COMMON ITEM : CONSULT-III Function (BCM - COMMON ITEM)

INFOID:000000003071482

APPLICATION ITEM

CONSULT-III performs the following functions via CAN communication with BCM.

Diagnosis mode	Function Description
WORK SUPPORT	Changes the setting for each system function.
SELF-DIAG RESULTS	Displays the diagnosis results judged by BCM. Refer to BCS-81, "DTC Index" .
CAN DIAG SUPPORT MNTR	Monitors the reception status of CAN communication viewed from BCM.
DATA MONITOR	The BCM input/output signals are displayed.
ACTIVE TEST	The signals used to activate each device are forcibly supplied from BCM.
ECU IDENTIFICATION	The BCM part number is displayed.
CONFIGURATION	This function is not used even though it is displayed.

SYSTEM APPLICATION

BCM can perform the following functions for each system.

NOTE:

It can perform the diagnosis modes except the following for all sub system selection items.

System	Sub system selection item	Diagnosis mode		
		WORK SUPPORT	DATA MONITOR	ACTIVE TEST
BCM	BCM	×		
RAP system	RETAINED PWR		×	

RETAINED PWR

RETAINED PWR : CONSULT-III Function (BCM - RETAINED PWR)

INFOID:000000003071483

Data monitor

Monitor Item	Description
DOOR SW-DR	Indicates [ON/OFF] condition of front door switch LH.
DOOR SW-AS	Indicates [ON/OFF] condition of front door switch RH.

POWER SUPPLY AND GROUND CIRCUIT

< COMPONENT DIAGNOSIS >

COMPONENT DIAGNOSIS

POWER SUPPLY AND GROUND CIRCUIT SUNROOF MOTOR ASSEMBLY

SUNROOF MOTOR ASSEMBLY : Description

INFOID:000000003071484

- BCM supplies power.
- CPU is integrated in sunroof motor assembly.
- Tilts up/down & slides open/close by sunroof switch operation.
- In order to close sunroof lid certainly with the signal from combination meter at the time of high speed run, the sunroof motor torque at the time of tilt-down operation is controlled.

SUNROOF MOTOR ASSEMBLY : Component Function Check

INFOID:000000003071485

1. CHECK SUNROOF MOTOR FUNCTION

Do tilt up/down & slide open/close functions operate normally with sunroof switch?

Is the inspection result normal?

YES >> Sunroof motor assembly is OK.

NO >> Refer to [RF-11. "SUNROOF MOTOR ASSEMBLY : Diagnosis Procedure"](#).

SUNROOF MOTOR ASSEMBLY : Diagnosis Procedure

INFOID:000000003071486

SUNROOF MOTOR ASSEMBLY

1. CHECK POWER SUPPLY CIRCUIT

1. Turn ignition switch OFF.
2. Disconnect sunroof motor assembly.
3. Turn ignition switch ON.
4. Check voltage between sunroof motor assembly connector and ground.

Terminal (+)		Terminal (-)	Voltage (V) (Approx.)
Sunroof motor assembly connector	Terminal		
R5	7	Ground	Battery voltage
	9		

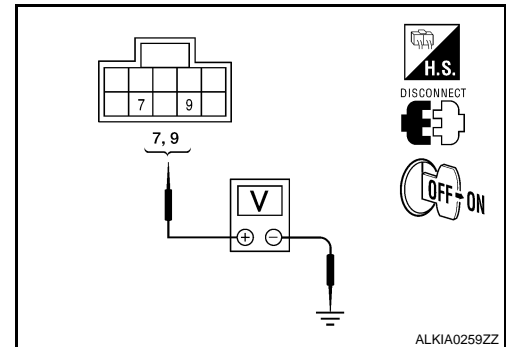

Is the measurement value within the specification?

YES >> GO TO 2

NO >> GO TO 3

2. CHECK GROUND CIRCUIT

1. Turn ignition switch OFF.
2. Check continuity between sunroof motor assembly connector and ground.

Sunroof motor assembly connector	Terminal	Ground	Continuity
R5	2	Ground	Yes

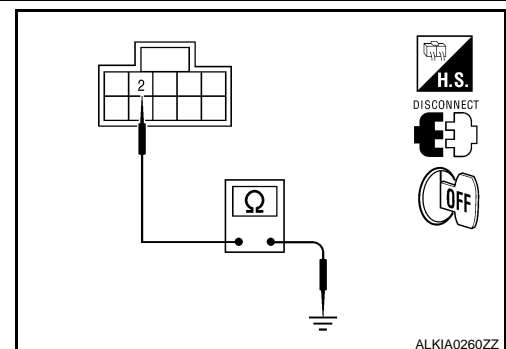

Is the inspection result normal?

YES >> GO TO 5

NO >> Repair or replace harness.

3. CHECK SUNROOF MOTOR CIRCUIT

POWER SUPPLY AND GROUND CIRCUIT

< COMPONENT DIAGNOSIS >

1. Turn ignition switch OFF.
2. Disconnect BCM.
3. Check continuity between BCM connector (A) and sunroof motor assembly connector (B).

BCM connector	Terminal	Sunroof motor assembly connector	Terminal	Continuity
M16 (A)	2	R5 (B)	7	Yes
	3		9	

4. Check continuity between BCM connector (A) and ground.

BCM connector	Terminal	Ground	Continuity
M16 (A)	2	Ground	No
	3		

Is the inspection result normal?

- YES >> GO TO 4
 NO >> Repair or replace harness.

4. CHECK BCM OUTPUT SIGNAL

1. Connect BCM.
2. Turn ignition switch ON.
3. Check voltage between BCM connector and ground.

Terminals		Voltage (V) (Approx.)
(+)	(-)	
BCM connector	Terminal	Battery voltage
M16	2	
		3

Is the measurement value within the specification?

- YES >> Check condition of harness and connector.
 NO >> Replace BCM. Refer to [BCS-85, "Removal and Installation"](#).

5. CHECK SUNROOF SWITCH INPUT SIGNAL

1. Connect sunroof motor assembly.
2. Turn ignition switch ON.
3. Check voltage between sunroof motor assembly connector and ground.

Sunroof motor assembly connector	Terminals		Condition	Voltage (V) (Approx.)
	(+)	(-)		
R5	5	Ground	Sunroof switch is operated TILT DOWN or SLIDE OPEN	0
			Other than above	Battery voltage
	1	Ground	Sunroof switch is operated TILT UP or SLIDE CLOSE	0
			Other than above	Battery voltage

Is the measurement value within the specification?

- YES >> GO TO 8
 NO >> GO TO 6

6. CHECK SUNROOF SWITCH CIRCUIT

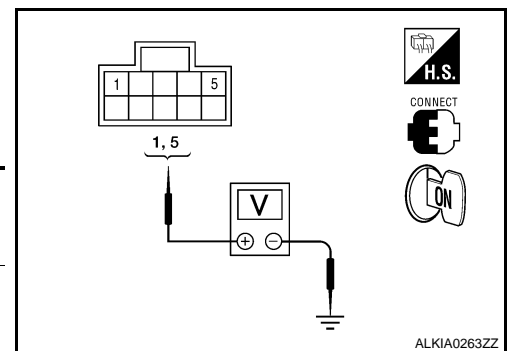
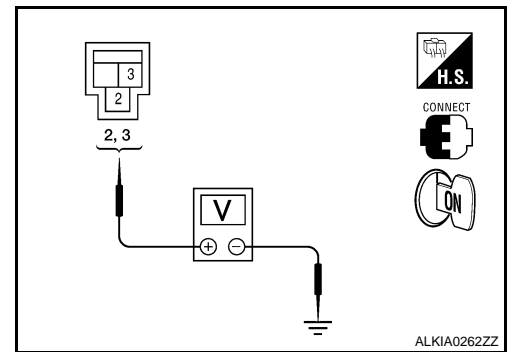
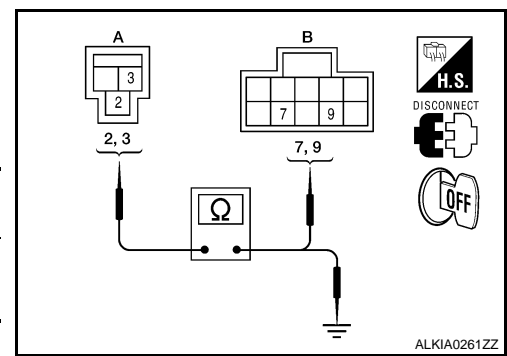

POWER SUPPLY AND GROUND CIRCUIT

< COMPONENT DIAGNOSIS >

1. Turn ignition switch OFF.
2. Disconnect sunroof motor assembly and sunroof switch.
3. Check continuity between sunroof motor assembly connector (A) and sunroof switch connector (B).

Sunroof motor assembly connector	Terminal	Sunroof switch connector	Terminal	Continuity
R5 (A)	5	R6 (B)	1	Yes
	1		3	

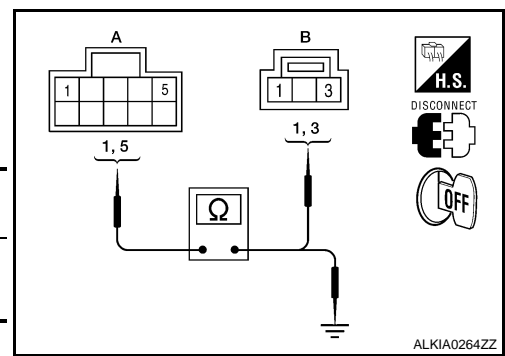

4. Check continuity between sunroof motor assembly connector (A) and ground.

Sunroof motor assembly connector	Terminal	Ground	Continuity
R5 (A)	5	Ground	No
	1		

Is the inspection result normal?

- YES >> GO TO 7
 NO >> Repair or replace harness.

7. CHECK SUNROOF SWITCH GROUND CIRCUIT

1. Connect sunroof motor assembly.
2. Check continuity between sunroof switch connector and ground.

Sunroof switch connector	Terminal	Ground	Continuity
R6	2	Ground	Yes

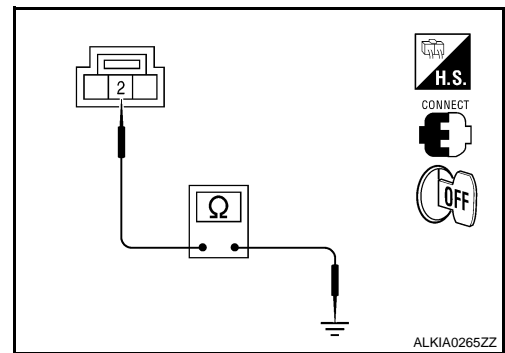

Is the inspection result normal?

- YES >> Refer to [RF-14. "SUNROOF MOTOR ASSEMBLY : Component Inspection"](#).
 NO >> Repair or replace harness.

8. CHECK COMBINATION METER SIGNAL

1. Connect sunroof motor assembly.
2. Turn ignition switch ON.
3. Check signal between sunroof motor assembly connector and ground with oscilloscope.

Terminals		Condition	Signal (Reference value)
(+)	(-)		
Sunroof motor assembly connector	Terminal	Ground	Speed meter operated [When vehicle speed is approx.40km/h (25MPH)]
R5	8		

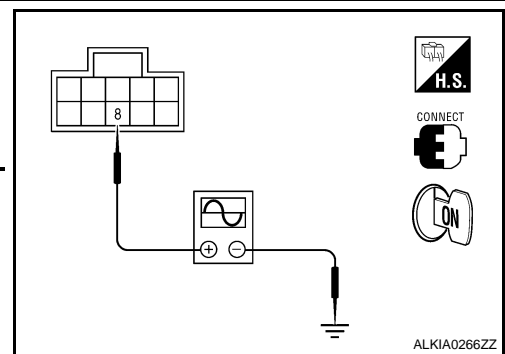

Is the inspection result normal?

- YES >> Replace sunroof motor assembly. Refer to [RF-64. "Removal and Installation"](#). After that, refer to [RF-14. "SUNROOF MOTOR ASSEMBLY : Special Repair Requirement"](#).

A
B
C
D
E
F
G
H
I
J
RF
L
M
N
O
P

POWER SUPPLY AND GROUND CIRCUIT

< COMPONENT DIAGNOSIS >

NO >> GO TO 9

9. CHECK COMBINATION METER CIRCUIT

1. Turn ignition switch OFF.
2. Disconnect combination meter.
3. Check continuity between combination meter connector (A) and sunroof motor assembly connector (B).

Combination meter connector	Terminal	Sunroof motor assembly connector	Terminal	Continuity
M24 (A)	8	R5 (B)	8	Yes

4. Check continuity between combination meter connector (A) and ground.

Combination meter connector	Terminal	Ground	Continuity
M24 (A)	8		No

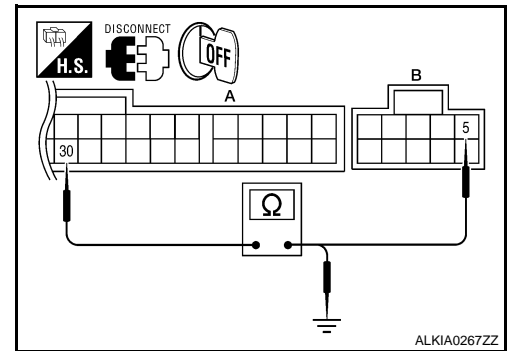

Is the inspection result normal?

YES >> Replace combination meter. Refer to [MWI-135, "Removal and Installation"](#).

NO >> Repair or replace harness.

SUNROOF MOTOR ASSEMBLY : Component Inspection

INFOID:000000003071487

SUNROOF SWITCH

1. CHECK SUNROOF SWITCH

1. Turn ignition switch OFF.
2. Disconnect sunroof switch.
3. Check continuity between sunroof switch terminals.

Terminals	Condition	Continuity	
1	2	Sunroof switch is operated TILT DOWN or SLIDE OPEN	Yes
		Other than above	No
3	2	Sunroof switch is operated TILT UP or SLIDE CLOSE	Yes
		Other than above	No

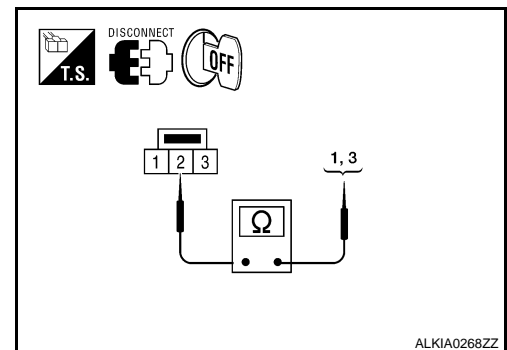

Is the inspection result normal?

YES >> Sunroof switch is OK.

NO >> Replace sunroof switch (map lamp assembly). Refer to [INT-18, "Removal and Installation"](#).

SUNROOF MOTOR ASSEMBLY : Special Repair Requirement

INFOID:000000003071488

1. PERFORM INITIALIZATION PROCEDURE

Perform initialization procedure.

Refer to [RF-6, "ADDITIONAL SERVICE WHEN REPLACING CONTROL UNIT : Special Repair Requirement"](#).

>> GO TO 2

2. CHECK ANTI-PINCH OPERATION

Check anti-pinch operation.

Refer to [RF-6, "ADDITIONAL SERVICE WHEN REPLACING CONTROL UNIT : Special Repair Requirement"](#).

Is the inspection result normal?

YES >> Inspection end.

NO >> Check fitting adjustment. Refer to [RF-64, "Removal and Installation"](#).

DOOR SWITCH

< COMPONENT DIAGNOSIS >

DOOR SWITCH

Description

INFOID:000000003292961

Detects door open/close condition.

Component Function Check

INFOID:000000003292962

1.CHECK FUNCTION

With CONSULT-III

Check door switches DOOR SW-DR, DOOR SW-AS, DOOR SW-RL, DOOR SW-RR in DATA MONITOR mode with CONSULT-III.

Monitor item	Condition
DOOR SW-DR	CLOSE → OPEN: OFF → ON
DOOR SW-AS	
DOOR SW-RL	
DOOR SW-RR	

Is the inspection result normal?

YES >> Door switch is OK.

NO >> Refer to [RF-15, "Diagnosis Procedure"](#).

Diagnosis Procedure

INFOID:000000003292963

1.CHECK DOOR SWITCH INPUT SIGNAL

1. Turn ignition switch OFF.
2. Check signal between BCM connector and ground with oscilloscope.

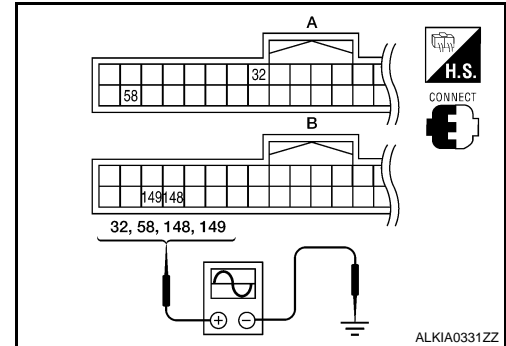

DOOR SWITCH

< COMPONENT DIAGNOSIS >

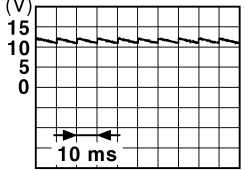
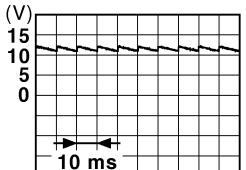
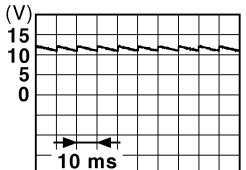
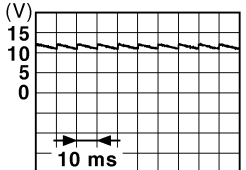
Terminals		(-)	Door condition		Voltage (V) (Approx.)	
(+)						
BCM connector	Terminal					
A: M18	58	Ground	Driver side	OPEN	0	
				CLOSE		
	32		Passenger side	OPEN	0	
				CLOSE		
B: M21	148		Ground	Rear RH	OPEN	0
					CLOSE	
	149			Rear LH	OPEN	0
					CLOSE	

Is the inspection result normal?

YES >> GO TO 4

NO >> GO TO 2

2. CHECK DOOR SWITCH CIRCUIT

1. Disconnect BCM connector.

DOOR SWITCH

< COMPONENT DIAGNOSIS >

- Check continuity between BCM connector and door switch connector.

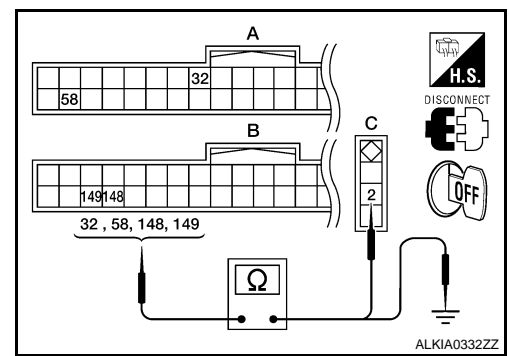

BCM connector	Terminal	Door switch connector	Terminal	Continuity
A: M18	58	C: B8 (Driver side)	2	Yes
	32	C: B108 (Passenger side)		
B: M21	148	C: B116 (Rear RH)		
	149	C: B18 (Rear LH)		

- Check continuity between BCM connector and ground.

BCM connector	Terminal		Continuity
A: M18	58	Ground	No
	32		
B: M21	148		
	149		

Is the inspection result normal?

YES >> GO TO 3

NO >> Repair or replace harness between BCM and door switch.

3.CHECK DOOR SWITCH

Refer to [RF-17, "Component Inspection"](#).

Is the inspection result normal?

YES >> GO TO 4

NO >> Replace malfunctioning door switch.

4.CHECK INTERMITTENT INCIDENT

Refer to [GI-42, "Intermittent Incident"](#).

>> INSPECTION END

Component Inspection

INFOID:000000003292964

1.CHECK DOOR SWITCH

- Turn ignition switch OFF.
- Disconnect door switch connector.

DOOR SWITCH

< COMPONENT DIAGNOSIS >

3. Check door switch.

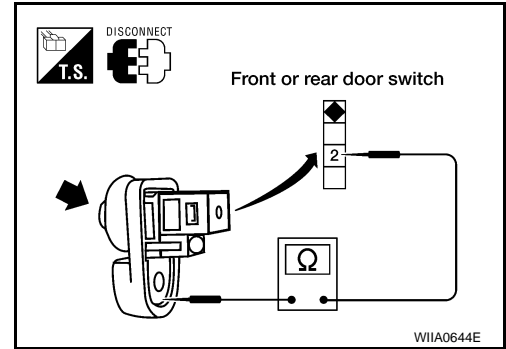

Terminal		Door switch condition	Continuity
Door switch			
2	Ground part of door switch	Pressed	No
		Released	Yes

Is the inspection result normal?

YES >> INSPECTION END.

NO >> Replace malfunction door switch.

BCM (BODY CONTROL MODULE)

< ECU DIAGNOSIS >

ECU DIAGNOSIS

BCM (BODY CONTROL MODULE)

Reference Value

INFOID:000000003292965

VALUES ON THE DIAGNOSIS TOOL

Monitor Item	Condition	Value/Status
FR WIPER HI	Other than front wiper switch HI	OFF
	Front wiper switch HI	ON
FR WIPER LOW	Other than front wiper switch LO	OFF
	Front wiper switch LO	ON
FR WASHER SW	Front washer switch OFF	OFF
	Front washer switch ON	ON
FR WIPER INT	Other than front wiper switch INT	OFF
	Front wiper switch INT	ON
FR WIPER STOP	Front wiper is not in STOP position	OFF
	Front wiper is in STOP position	ON
INT VOLUME	Wiper intermittent dial is in a dial position 1 - 7	Wiper intermittent dial position
TURN SIGNAL R	Other than turn signal switch RH	OFF
	Turn signal switch RH	ON
TURN SIGNAL L	Other than turn signal switch LH	OFF
	Turn signal switch LH	ON
TAIL LAMP SW	Other than lighting switch 1ST and 2ND	OFF
	Lighting switch 1ST or 2ND	ON
HI BEAM SW	Other than lighting switch HI	OFF
	Lighting switch HI	ON
HEAD LAMP SW 1	Other than lighting switch 2ND	OFF
	Lighting switch 2ND	ON
HEAD LAMP SW 2	Other than lighting switch 2ND	OFF
	Lighting switch 2ND	ON
PASSING SW	Other than lighting switch PASS	OFF
	Lighting switch PASS	ON
AUTO LIGHT SW	Other than lighting switch AUTO	OFF
	Lighting switch AUTO	ON
FR FOG SW	Front fog lamp switch OFF	OFF
	Front fog lamp switch ON	ON
DOOR SW-DR	Front door LH closed	OFF
	Front door LH opened	ON
DOOR SW-AS	Front door RH closed	OFF
	Front door RH opened	ON
DOOR SW-RR	Rear door RH closed	OFF
	Rear door RH opened	ON
DOOR SW-RL	Rear door LH closed	OFF
	Rear door LH opened	ON

BCM (BODY CONTROL MODULE)

< ECU DIAGNOSIS >

Monitor Item	Condition	Value/Status
DOOR SW-BK	NOTE: This item is displayed, but cannot be monitored.	OFF
CDL LOCK SW	Other than power door lock switch LOCK	OFF
	Door lock/unlock switch LOCK	ON
CDL UNLOCK SW	Other than door lock/unlock switch UNLOCK	OFF
	Door lock/unlock switch UNLOCK	ON
KEY CYL LK-SW	Other than front door LH key cylinder LOCK position	OFF
	Front door LH key cylinder LOCK position	ON
KEY CYL UN-SW	Other than front door LH key cylinder UNLOCK position	OFF
	Front door LH key cylinder UNLOCK position	ON
KEY CYL SW-TR	NOTE: This item is displayed, but cannot be monitored.	OFF
HAZARD SW	When hazard switch is not pressed	OFF
	When hazard switch is pressed	ON
REAR DEF SW	When rear window defogger switch is pressed	ON
FAN ON SIG	When AUTO switch or fan switch is pressed	ON
AIR COND SW	When A/C switch is pressed	ON
TR CANCEL SW	Trunk lid opener cancel switch OFF	OFF
	Trunk lid opener cancel switch ON	ON
TR/BD OPEN SW	Trunk lid opener switch OFF	OFF
	While the trunk lid opener switch is turned ON	ON
TRNK/HAT MNTR	Trunk lid closed	OFF
	Trunk lid opened	ON
RKE-LOCK	When LOCK button of Intelligent Key is not pressed	OFF
	When LOCK button of Intelligent Key is pressed	ON
RKE-UNLOCK	When UNLOCK button of Intelligent Key is not pressed	OFF
	When UNLOCK button of Intelligent Key is pressed	ON
RKE-TR/BD	When TRUNK OPEN button of Intelligent Key is not pressed	OFF
	When TRUNK OPEN button of Intelligent Key is pressed	ON
RKE-PANIC	When PANIC button of Intelligent Key is not pressed	OFF
	When PANIC button of Intelligent Key is pressed	ON
RKE-P/W OPEN	When UNLOCK button of Intelligent Key is not pressed and held	OFF
	When UNLOCK button of Intelligent Key is pressed and held	ON
RKE-MODE CHG	When LOCK/UNLOCK button of Intelligent Key is not pressed and held simultaneously	OFF
	When LOCK/UNLOCK button of Intelligent Key is pressed and held simultaneously	ON
OPTICAL (LIGHT) SEN-SOR	When outside of the vehicle is bright	Close to 5 V
	When outside of the vehicle is dark	Close to 0 V
REQ SW-DR	When front door LH request switch is not pressed	OFF
	When front door LH request switch is pressed	ON
REQ SW-AS	When front door RH request switch is not pressed	OFF
	When front door RH request switch is pressed	ON
REQ SW-BD/TR	When trunk request switch is not pressed	OFF
	When trunk request switch is pressed	ON

BCM (BODY CONTROL MODULE)

< ECU DIAGNOSIS >

Monitor Item	Condition	Value/Status	
PUSH SW	When push-button ignition switch is not pressed	OFF	A
	When push-button ignition switch is pressed	ON	
IGN RLY -F/B	Ignition switch OFF or ACC	OFF	B
	Ignition switch ON	ON	
ACC RLY -F/B	Ignition switch OFF	OFF	C
	Ignition switch ACC or ON	ON	
BRAKE SW 1	When the brake pedal is not depressed	ON	
	When the brake pedal is depressed	OFF	D
DETE/CANCL SW	When selector lever is in P position	OFF	
	When selector lever is in any position other than P	ON	E
SFT PN/N SW	When selector lever is in any position other than P or N	OFF	
	When selector lever is in P or N position	ON	F
S/L -LOCK	Electronic steering column lock LOCK status	OFF	
	Electronic steering column lock UNLOCK status	ON	G
S/L -UNLOCK	Electronic steering column lock UNLOCK status	OFF	
	Electronic steering column lock LOCK status	ON	H
S/L RELAY-F/B	Ignition switch OFF or ACC	OFF	
	Ignition switch ON	ON	I
UNLK SEN-DR	Front door LH UNLOCK status	OFF	
	Front door LH LOCK status	ON	J
PUSH SW -IPDM	When push-button ignition switch is not pressed (IPDM E/R sends via CAN)	OFF	
	When push-button ignition switch is pressed (IPDM E/R sends via CAN)	ON	RF
IGN RLY1 F/B	Ignition switch OFF or ACC	OFF	
	Ignition switch ON	ON	L
DETE SW -IPDM	When selector lever is in P position (IPDM E/R sends via CAN)	OFF	
	When selector lever is in any position other than P (IPDM E/R sends via CAN)	ON	M
SFT PN -IPDM	When selector lever is in any position other than P or N (IPDM E/R sends via CAN)	OFF	
	When selector lever is in P or N position (IPDM E/R sends via CAN)	ON	N
SFT P -MET	When selector lever is in any position other than P (combination meter sends via CAN)	OFF	
	When selector lever is in P position (combination meter sends via CAN)	ON	O
SFT N -MET	When selector lever is in any position other than N (combination meter sends via CAN)	OFF	
	When selector lever is in N position (combination meter sends via CAN)	ON	P
ENGINE STATE	Engine stopped	STOP	
	While the engine stalls	STALL	
	At engine cranking	CRANK	
	Engine running	RUN	
S/L LOCK-IPDM	Electronic steering column lock LOCK status (IPDM E/R sends via CAN)	OFF	
	Electronic steering column lock UNLOCK status (IPDM E/R sends via CAN)	ON	

BCM (BODY CONTROL MODULE)

< ECU DIAGNOSIS >

Monitor Item	Condition	Value/Status
S/L UNLCK-IPDM	Electronic steering column lock UNLOCK status (IPDM E/R sends via CAN)	OFF
	Electronic steering column lock LOCK status (IPDM E/R sends via CAN)	ON
S/L RELAY-REQ	Ignition switch OFF or ACC	OFF
	Ignition switch ON	ON
VEH SPEED 1	While driving	Equivalent to speedometer reading
VEH SPEED 2	While driving	Equivalent to speedometer reading
DR DOOR STATE	Front door LH LOCK status	LOCK
	Wait with selective UNLOCK operation (5 seconds)	READY
	Front door LH UNLOCK status	UNLK
AS DOOR STATE	Front door RH LOCK status	LOCK
	Wait with selective UNLOCK operation (5 seconds)	READY
	Front door RH UNLOCK status	UNLK
ID OK FLAG	Ignition switch ACC or ON	RESET
	Ignition switch OFF	SET
PRMT ENG STAT	When the hybrid system start is prohibited	RESET
	When the hybrid system start is permitted	SET
PRMT RKE STAT	NOTE: This item is displayed, but cannot be monitored.	RESET
KEY SW -SLOT	When Intelligent Key is not inserted into key slot	OFF
	When Intelligent Key is inserted into key slot	ON
RKE OPE COUN1	During the operation of Intelligent Key	Operation frequency of Intelligent Key
RKE OPE COUN2	NOTE: This item is displayed, but cannot be monitored.	Operation frequency of Intelligent Key
AIR PRESS FL	Ignition switch ON (only when the signal from the transmitter is received)	Air pressure of front LH tire
AIR PRESS FR	Ignition switch ON (only when the signal from the transmitter is received)	Air pressure of front RH tire
AIR PRESS RR	Ignition switch ON (only when the signal from the transmitter is received)	Air pressure of rear RH tire
AIR PRESS RL	Ignition switch ON (only when the signal from the transmitter is received)	Air pressure of rear LH tire
ID REGST FL1	When ID of front LH tire transmitter is registered (refer to WT-6, "ID Registration Procedure")	DONE
	When ID of front LH tire transmitter is not registered (refer to WT-6, "ID Registration Procedure")	YET
ID REGST FR1	When ID of front RH tire transmitter is registered (refer to WT-6, "ID Registration Procedure")	DONE
	When ID of front RH tire transmitter is not registered (refer to WT-6, "ID Registration Procedure")	YET
ID REGST RR1	When ID of rear RH tire transmitter is registered (refer to WT-6, "ID Registration Procedure")	DONE
	When ID of rear RH tire transmitter is not registered (refer to WT-6, "ID Registration Procedure")	YET
ID REGST RL1	When ID of rear LH tire transmitter is registered (refer to WT-6, "ID Registration Procedure")	DONE
	When ID of rear LH tire transmitter is not registered (refer to WT-6, "ID Registration Procedure")	YET

BCM (BODY CONTROL MODULE)

< ECU DIAGNOSIS >

Monitor Item	Condition	Value/Status
WARNING LAMP	Tire pressure indicator OFF	OFF
	Tire pressure indicator ON	ON

Terminal Layout

INFOID:000000003292966

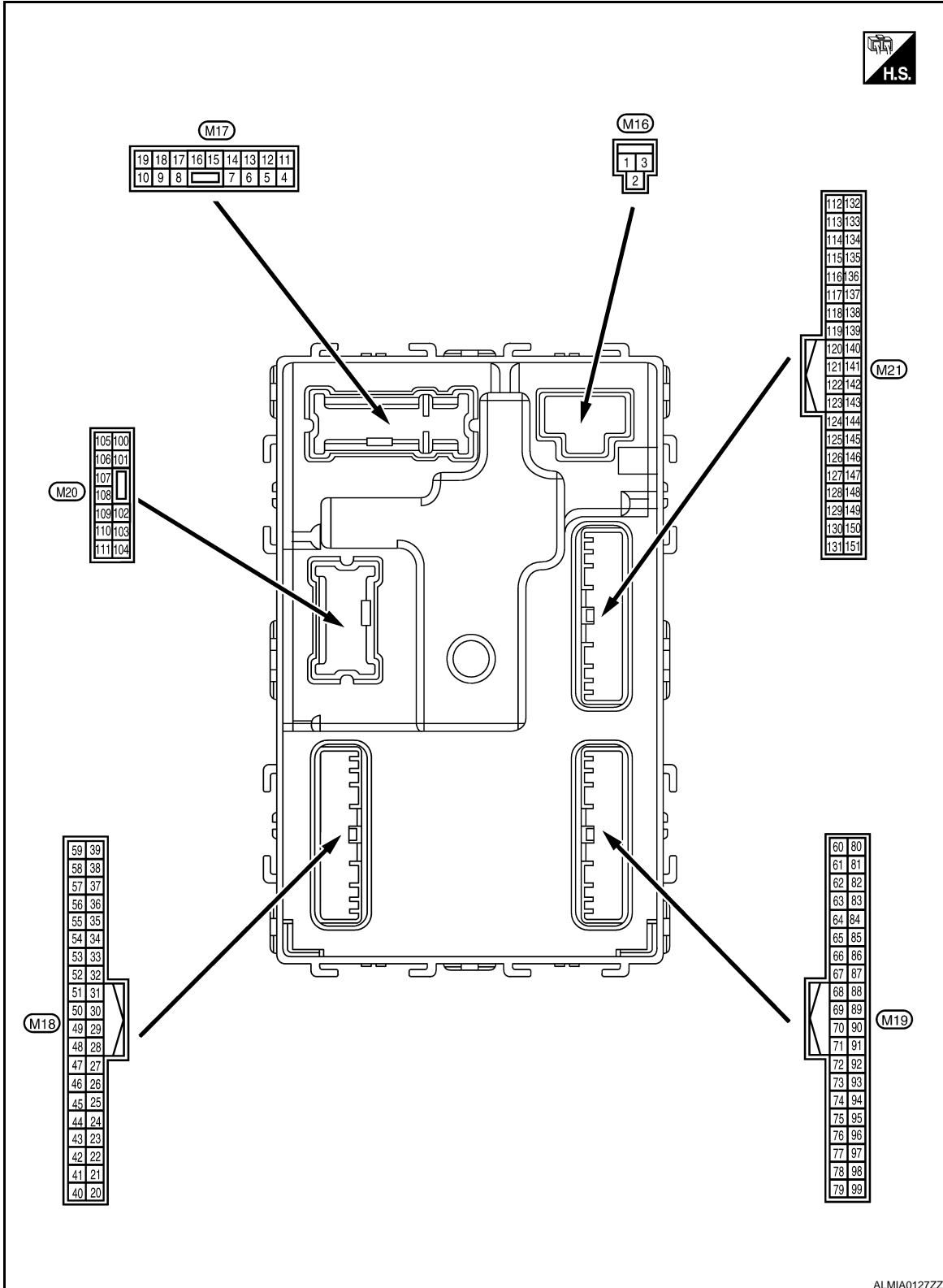

A
B
C
D
E
F
G
H
I
J
RF
L
M
N
O
P

ALMIA0127ZZ

BCM (BODY CONTROL MODULE)

< ECU DIAGNOSIS >

Physical Values

INFOID:000000003292967

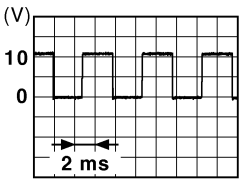
Terminal No. (Wire color)		Description		Condition		Value (Approx.)
(+)	(-)	Signal name	Input/ Output			
1 (W/B)	Ground	Battery power supply	Input	Ignition switch OFF		Battery voltage
2 (R/Y)	Ground	Battery power supply output	Output	Ignition switch OFF		Battery voltage
3 (L/W)	Ground	Ignition power supply output	Output	Ignition switch ON		Battery voltage
4 (P/W)	Ground	Interior room lamp power supply	Output	After passing the interior room lamp battery saver operation time		0V
				Any other time after passing the interior room lamp battery saver operation time		Battery voltage
5 (G/Y)	Ground	Front door RH UNLOCK	Output	Front door RH	UNLOCK (actuator is activated)	Battery voltage
					Other than UNLOCK (actuator is not activated)	0V
7 (R/W)	Ground	Step lamp	Output	Room lamp timer	ON	Battery voltage
					OFF	0V
8 (V)	Ground	All doors LOCK	Output	All doors	LOCK (actuator is activated)	Battery voltage
					Other than LOCK (actuator is not activated)	0V
9 (G)	Ground	Front door LH UNLOCK	Output	Front door LH	UNLOCK (actuator is activated)	Battery voltage
					Other than UNLOCK (actuator is not activated)	0V
10 (G/Y)	Ground	Rear door RH and rear door LH UNLOCK	Output	Rear door RH and rear door LH	UNLOCK (actuator is activated)	Battery voltage
					Other than UNLOCK (actuator is not activated)	0V
11 (Y/R)	Ground	Battery power supply	Input	Ignition switch OFF		Battery voltage
13 (B)	Ground	Ground	—	Ignition switch ON		0V
14 (R/Y)	Ground	Push-button ignition switch illumination ground	Input	Tail lamp	OFF	<p>NOTE: When the illumination brightening/dimming level is in the neutral position</p> 
					ON	
15 (Y/L)	Ground	ACC indicator lamp	Output	Ignition switch	OFF	Battery voltage
					ACC	0V

JSNIA0010GB

BCM (BODY CONTROL MODULE)

< ECU DIAGNOSIS >

Terminal No. (Wire color)		Description		Condition	Value (Approx.)	
(+)	(-)	Signal name	Input/ Output			
17 (G/B)	Ground	Turn signal (RH)	Output	Turn signal switch OFF	0V	
				Turn signal switch ON	Turn signal switch RH	
18 (G/O)	Ground	Turn signal (LH)	Output	Turn signal switch OFF	0V	
				Turn signal switch ON	Turn signal switch LH	
19 (Y)	Ground	Room lamp timer control	Output	Interior room lamp	Lamps fully OFF	Battery voltage
				Lamps fully ON	0V	
21 (P/B)	Ground	Optical sensor signal	Input	Ignition switch ON	When outside of the vehicle is bright	Close to 5V
				When outside of the vehicle is dark	Close to 0V	
24 (R/W)	Ground	Stop lamp switch 1	Input	—	Battery voltage	
26 (O/L)	Ground	Stop lamp switch 2	Input	Stop lamp switch	OFF (brake pedal is not depressed)	0V
				ON (brake pedal is depressed)	Battery voltage	
			ICC brake hold relay (with ICC)	OFF	0V	
				ON	Battery voltage	
27 (G/W)	Ground	Front door lock assembly LH (unlock sensor)	Input	Front door LH	LOCK status	
					UNLOCK status	0V
				Key slot switch	Input	When Intelligent Key is inserted into key slot
29 (Y)	Ground	Key slot switch	Input	When Intelligent Key is not inserted into key slot	0V	
				ACC feedback signal	Input	Ignition switch
30 (V/Y)	Ground	ACC feedback signal	Input	Ignition switch	ACC or ON	Battery voltage
				Ignition relay-2 feedback signal	Input	Ignition switch
31 (G)	Ground	Ignition relay-2 feedback signal	Input	Ignition switch	ON	Battery voltage

A
B
C
D
E
F
G
H
I
J
RF
L
M
N
O
P

BCM (BODY CONTROL MODULE)

< ECU DIAGNOSIS >

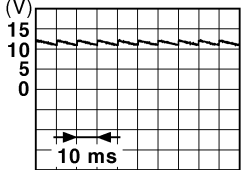
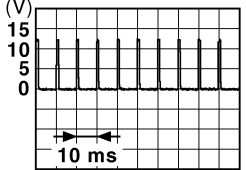
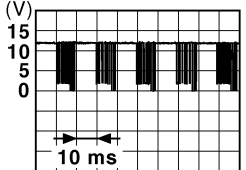
Terminal No. (Wire color)		Description		Condition		Value (Approx.)
(+)	(-)	Signal name	Input/ Output			
32 (R/B)	Ground	Front door RH switch	Input	Front door RH switch	OFF (when front door RH closes)	 <p style="text-align: right; font-size: small;">JPMIA0011GB</p> <p style="text-align: center;">11.8V</p>
					ON (when front door RH opens)	0V
33 (SB)	Ground	Compressor ON signal	Input	A/C switch	OFF	Battery voltage
					ON	0V
34* (L/R)	Ground	Front door lock assembly LH (key cylinder switch) (unlock)	Input	Front door lock assembly LH (key cylinder switch)	OFF (neutral)	Battery voltage
					ON (unlock)	0V
36* (GR)	Ground	Lock switch signal	Input	Door lock/unlock switch	Lock	Battery Voltage
					Unlock	0V
37 (O)	Ground	Trunk lid opener cancel switch	Input	Trunk lid opener cancel switch	CANCEL	 <p style="text-align: right; font-size: small;">JPMIA0012GB</p> <p style="text-align: center;">1.1V</p>
					ON	0V
38 (GR/W)	Ground	Rear window defogger ON signal	Input	Rear window defogger switch	OFF	Battery Voltage V
					ON	0V
39* (GR/R)	Ground	Unlock switch signal	Input	Door lock/unlock switch	Unlock	Battery Voltage
					Lock	0V
40* (Y/G)	Ground	Power window serial link	Input/ Output	Ignition switch ON	 <p style="text-align: right; font-size: small;">JPMIA0013GB</p> <p style="text-align: center;">10.2V</p>	
				Ignition switch OFF or ACC	0V	
41 (W)	Ground	Push-button ignition switch illumination	Output	Engine switch (push switch) illumination	ON	5.5V
					OFF	0V
42 (R)	Ground	LOCK indicator lamp	Output	LOCK indicator lamp	ON	0V
					OFF	Battery voltage
45 (P)	Ground	Receiver & sensor ground	Input	Ignition switch ON	0V	

BCM (BODY CONTROL MODULE)

< ECU DIAGNOSIS >

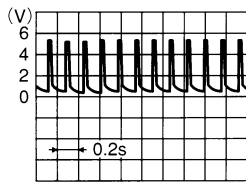
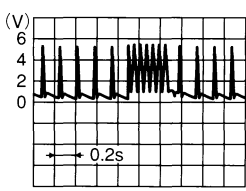
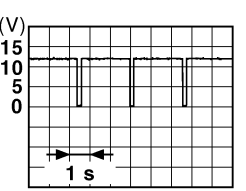
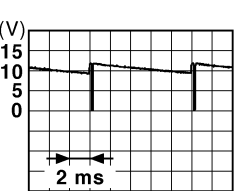
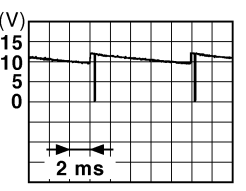
Terminal No. (Wire color)		Description		Condition		Value (Approx.)
(+)	(-)	Signal name	Input/ Output			
46 (V/W)	Ground	Receiver & sensor power supply output	Output	Ignition switch	OFF	0V
					ACC or ON	5.0V
47 (G/O)	Ground	Tire pressure receiver signal	Input/ Output	Ignition switch ON	Standby state	 OCC3881D
					When receiving the signal from the transmitter	 OCC3880D
48 (R/B)	Ground	Selector lever P/N position signal	Input	Selector lever	P or N position	12.0V
					Except P and N positions	0V
49 (L/O)	Ground	Security indicator signal	Output	Security indicator	Blinking	 JPMIA0014GB 11.3V
					OFF	Battery voltage
50 (LG/ B)	Ground	Combination switch OUTPUT 5	Output	Combination switch (Wiper intermittent dial 4)	All switch OFF	0V
					Lighting switch 1ST	 JPMIA0031GB 10.7V
					Lighting switch high-beam	
					Lighting switch 2ND	
Turn signal switch RH						
51 (L/W)	Ground	Combination switch OUTPUT 1	Output	Combination switch	All switch OFF (Wiper intermittent dial 4)	0V
					Front wiper switch HI (Wiper intermittent dial 4)	 JPMIA0032GB 10.7V
					Any of the conditions below with all switch OFF	
					<ul style="list-style-type: none"> • Wiper intermittent dial 1 • Wiper intermittent dial 2 • Wiper intermittent dial 3 • Wiper intermittent dial 6 • Wiper intermittent dial 7 	

A
B
C
D
E
F
G
H
I
J
RF
L
M
N
O
P

BCM (BODY CONTROL MODULE)

< ECU DIAGNOSIS >

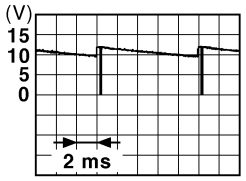
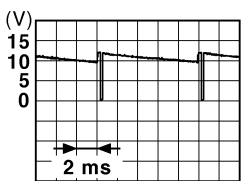
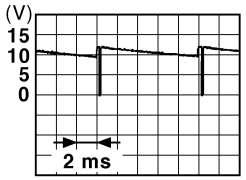
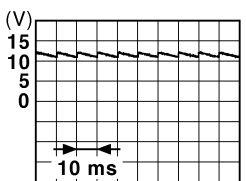
Terminal No. (Wire color)		Description		Condition	Value (Approx.)	
(+)	(-)	Signal name	Input/ Output			
52 (G/B)	Ground	Combination switch OUTPUT 2	Output	Combination switch	All switch OFF (Wiper intermittent dial 4)	0V
					Front washer switch ON (Wiper intermittent dial 4)	 <p style="text-align: right; font-size: small;">JPMIA0033GB</p>
					Any of the conditions below with all switch OFF	
					<ul style="list-style-type: none"> • Wiper intermittent dial 1 • Wiper intermittent dial 5 • Wiper intermittent dial 6 	
					10.7V	
53 (LG/ R)	Ground	Combination switch OUTPUT 3	Output	Combination switch (Wiper intermit- tent dial 4)	All switch OFF	0V
					Front wiper switch INT	 <p style="text-align: right; font-size: small;">JPMIA0034GB</p>
					Front wiper switch LO	
					Lighting switch AUTO	
					10.7V	
54 (G/Y)	Ground	Combination switch OUTPUT 4	Output	Combination switch (Wiper intermit- tent dial 4)	All switch OFF	0V
					Front fog lamp switch ON	 <p style="text-align: right; font-size: small;">JPMIA0035GB</p>
					Lighting switch 2ND	
					Lighting switch flash-to- pass	
					Turn signal switch LH	
					10.7V	
55 (BR/ W)	Ground	Front blower monitor	Input	Front blower mo- tor switch	ON	Battery voltage
					OFF	0V
56 (L/B)	Ground	Front door lock as- sembly LH (key cylin- der switch) (lock)	Input	Front door lock assembly LH (key cylinder switch)	OFF (neutral)	Battery voltage
					ON (lock)	0V
57 (W)	Ground	Tire pressure warn- ing check switch	Input	—	—	Battery voltage
58 (SB)	Ground	Front door LH switch	Input	Front door LH switch	OFF (front door LH CLOSE)	 <p style="text-align: right; font-size: small;">JPMIA0011GB</p>
					ON (front door LH OPEN)	
59 (G/R)	Ground	Rear window defog- ger relay	Output	Rear window de- fogger	Active	Battery voltage
					Not activated	0V

BCM (BODY CONTROL MODULE)

< ECU DIAGNOSIS >

Terminal No. (Wire color)		Description		Condition	Value (Approx.)
(+)	(-)	Signal name	Input/ Output		
60 (B/R)	Ground	Front console antenna 2 (-)	Output	Ignition switch OFF	<p>JMKIA0062GB</p>
				When Intelligent Key is not in the passenger compartment	<p>JMKIA0063GB</p>
61 (W/R)	Ground	Center console antenna 2 (+)	Output	Ignition switch OFF	<p>JMKIA0062GB</p>
				When Intelligent Key is not in the passenger compartment	<p>JMKIA0063GB</p>
62 (B/Y)	Ground	Front outside handle RH antenna (-)	Output	When the front door RH request switch is operated with ignition switch OFF	<p>JMKIA0062GB</p>
				When Intelligent Key is not in the antenna detection area	<p>JMKIA0063GB</p>

A
B
C
D
E
F
G
H
I
J
L
M
N
O
P

RF

BCM (BODY CONTROL MODULE)

< ECU DIAGNOSIS >

Terminal No. (Wire color)		Description		Condition	Value (Approx.)
(+)	(-)	Signal name	Input/ Output		
63 (LG)	Ground	Front outside handle RH antenna (+)	Output	When the front door RH request switch is operated with ignition switch OFF	<p style="text-align: right; font-size: small;">JMKIA0062GB</p>
				When Intelligent Key is not in the antenna detection area	<p style="text-align: right; font-size: small;">JMKIA0063GB</p>
64 (V)	Ground	Front outside handle LH antenna (-)	Output	When the front door LH request switch is operated with ignition switch OFF	<p style="text-align: right; font-size: small;">JMKIA0062GB</p>
				When Intelligent Key is not in the antenna detection area	<p style="text-align: right; font-size: small;">JMKIA0063GB</p>
65 (P)	Ground	Front outside handle LH antenna (+)	Output	When the front door LH request switch is operated with ignition switch OFF	<p style="text-align: right; font-size: small;">JMKIA0062GB</p>
				When Intelligent Key is not in the antenna detection area	<p style="text-align: right; font-size: small;">JMKIA0063GB</p>

BCM (BODY CONTROL MODULE)

< ECU DIAGNOSIS >



Terminal No. (Wire color)		Description		Condition	Value (Approx.)
(+)	(-)	Signal name	Input/ Output		
66 (R)	Ground	Instrument panel antenna (-)	Output	Ignition switch OFF	<p>JMKIA0062GB</p>
				When Intelligent Key is not in the passenger compartment	<p>JMKIA0063GB</p>
67 (G)	Ground	Instrument panel antenna (+)	Output	Ignition switch OFF	<p>JMKIA0062GB</p>
				When Intelligent Key is not in the passenger compartment	<p>JMKIA0063GB</p>
68 (G/O)	Ground	NATS antenna amp (built in key slot)	Input/ Output	During waiting	Just after pressing ignition switch. Pointer of tester should move.
69 (O)	Ground	NATS antenna amp (built in key slot)	Input/ Output	During waiting	Just after pressing ignition switch. Pointer of tester should move.
70 (R/B)	Ground	Ignition relay-2 control	Output	Ignition switch OFF or ACC	0V
				ON	Battery voltage

A
B
C
D
E
F
G
H
I
J
L
M
N
O
P

RF

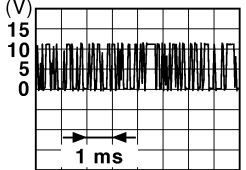
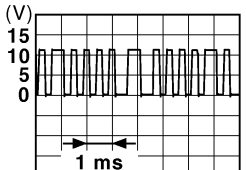
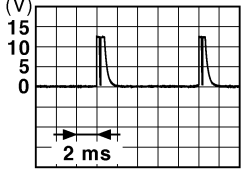

BCM (BODY CONTROL MODULE)

< ECU DIAGNOSIS >

Terminal No. (Wire color)		Description		Condition	Value (Approx.)
(+)	(-)	Signal name	Input/ Output		
71 (L/O)	Ground	Remote keyless entry receiver signal	Input/ Output	During waiting	 <p style="text-align: right; font-size: small;">JMKIA0064GB</p>
				When operating either button on Intelligent Key	 <p style="text-align: right; font-size: small;">JMKIA0065GB</p>
75 (R/Y)	Ground	Combination switch INPUT 5	Input	Combination switch	<p>Any of the conditions below with all switch OFF</p> <ul style="list-style-type: none"> • Wiper intermittent dial 1 • Wiper intermittent dial 2 • Wiper intermittent dial 6 • Wiper intermittent dial 7
				Front fog lamp switch ON (Wiper intermittent dial 4)	 <p style="text-align: right; font-size: small;">JPMIA0037GB</p> <p style="text-align: center;">1.3V</p>
				All switch OFF (Wiper intermittent dial 4)	 <p style="text-align: right; font-size: small;">JPMIA0041GB</p> <p style="text-align: center;">1.4V</p>

BCM (BODY CONTROL MODULE)

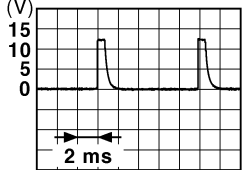
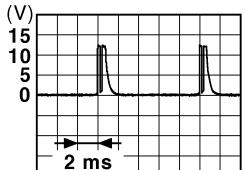
< ECU DIAGNOSIS >

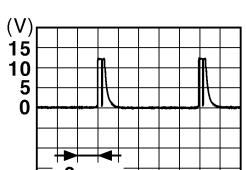
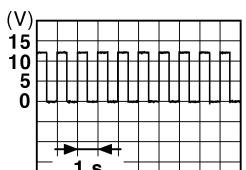
Terminal No. (Wire color)		Description		Condition	Value (Approx.)	
		Signal name	Input/ Output			
(+)	(-)					
76 (R/G)	Ground	Combination switch INPUT 3	Input	Combination switch	All switch OFF (Wiper intermittent dial 4)	 <small>JPMIA0041GB</small> 1.4V
					Lighting switch high-beam (Wiper intermittent dial 4)	 <small>JPMIA0036GB</small> 1.3V
					Lighting switch 2ND (Wiper intermittent dial 4)	 <small>JPMIA0037GB</small> 1.3V
					Any of the conditions below with all switch OFF <ul style="list-style-type: none"> • Wiper intermittent dial 1 • Wiper intermittent dial 2 • Wiper intermittent dial 3 	 <small>JPMIA0040GB</small> 1.3V
77 (BR)	Ground	Push-button ignition switch	Input	Engine switch (push switch)	Pressed	0V
					Not pressed	Battery voltage
78 (P)	Ground	CAN-L	Input/ Output	—	—	
79 (L)	Ground	CAN-H	Input/ Output	—	—	
80 (R/L)	Ground	Key slot illumination	Output	Key slot illumina- tion	OFF	0V
					Blinking	 <small>JPMIA0015GB</small> 6.5V
					ON	Battery voltage

A
B
C
D
E
F
G
H
I
J
L
M
N
O
P

RF



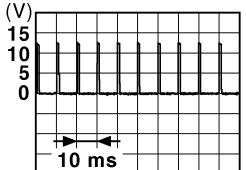
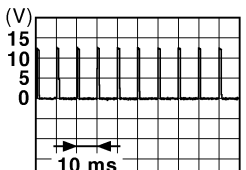

BCM (BODY CONTROL MODULE)

< ECU DIAGNOSIS >

Terminal No. (Wire color)		Description		Condition		Value (Approx.)
(+)	(-)	Signal name	Input/ Output			
81 (LG)	Ground	ON indicator lamp	Output	Ignition switch	OFF or ACC	Battery voltage
					ON	0V
83 (L)	Ground	ACC relay control	Output	Ignition switch	OFF	0V
					ACC or ON	Battery voltage
84 (Y/R)	Ground	ECTV device (detent switch)	Output	—		Battery voltage
85 (L/O)	Ground	Electronic steering column lock condition No. 1	Input	Electronic steering column lock	Lock status	0V
					Unlock status	Battery voltage
86 (G/R)	Ground	Electronic steering column lock condition No. 2	Input	Electronic steering column lock	Lock status	Battery voltage
					Unlock status	0V
87 (G/B)	Ground	ECTV device (detent switch)	Input	Selector lever	P position	0V
					Any position other than P	Battery voltage
88 (P/L)	Ground	Front door RH request switch	Input	Front door RH request switch	ON (pressed)	0V
					OFF (not pressed)	 <p style="text-align: center;">1.0V</p>
89 (B/W)	Ground	Front door LH request switch	Input	Front door LH request switch	ON (pressed)	0V
					OFF (not pressed)	 <p style="text-align: center;">1.0V</p>
90 (Y)	Ground	Front blower motor relay control	Output	Ignition switch	OFF or ACC	0V
					ON	Battery voltage
91 (L/R)	Ground	Remote keyless entry receiver power supply	Output	Ignition switch OFF		Battery voltage
94 (G/Y)	Ground	Electronic steering column lock CPU power supply	Output	Ignition switch	OFF or ACC	Battery voltage
					ON	0V

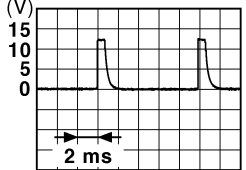
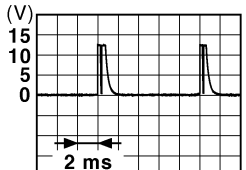
BCM (BODY CONTROL MODULE)

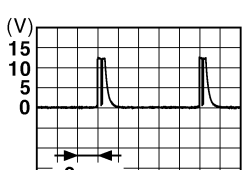
< ECU DIAGNOSIS >

Terminal No. (Wire color)		Description		Condition	Value (Approx.)
(+)	(-)	Signal name	Input/ Output		
95 (R/W)	Ground	Combination switch INPUT 1	Input	Combination switch (Wiper intermittent dial 4)	All switch OFF  1.4V
					Turn signal switch LH  1.3V
					Turn signal switch RH  1.3V
					Front wiper switch LO  1.3V
					Front washer switch ON  1.3V

A
B
C
D
E
F
G
H
I
J
RF
L
M
N
O
P



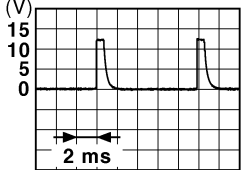
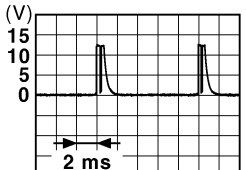
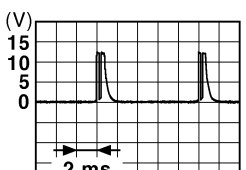
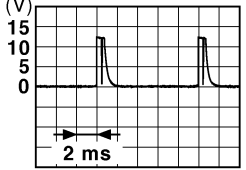

BCM (BODY CONTROL MODULE)

< ECU DIAGNOSIS >

Terminal No. (Wire color)		Description		Condition	Value (Approx.)
(+)	(-)	Signal name	Input/ Output		
96 (P/B)	Ground	Combination switch INPUT 4	Input	Combination switch	All switch OFF (Wiper intermittent dial 4)  <p style="text-align: right; font-size: small;">JPMIA0041GB</p> <p style="text-align: center;">1.4V</p>
					Lighting switch AUTO (Wiper intermittent dial 4)  <p style="text-align: right; font-size: small;">JPMIA0038GB</p> <p style="text-align: center;">1.3V</p>
					Lighting switch 1ST (Wiper intermittent dial 4)  <p style="text-align: right; font-size: small;">JPMIA0036GB</p> <p style="text-align: center;">1.3V</p>
					Any of the conditions below with all switch OFF <ul style="list-style-type: none"> • Wiper intermittent dial 1 • Wiper intermittent dial 5 • Wiper intermittent dial 6  <p style="text-align: right; font-size: small;">JPMIA0039GB</p> <p style="text-align: center;">1.3V</p>

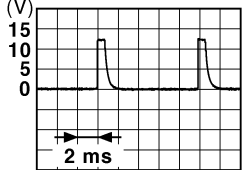
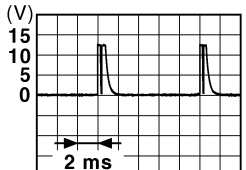
BCM (BODY CONTROL MODULE)

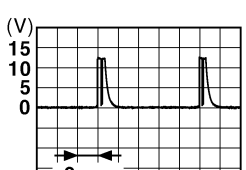
< ECU DIAGNOSIS >

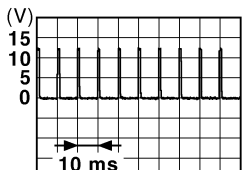
Terminal No. (Wire color)		Description		Condition	Value (Approx.)	
(+)	(-)	Signal name	Input/ Output			
97 (R/B)	Ground	Combination switch INPUT 2	Input	Combination switch (Wiper intermittent dial 4)	All switch OFF	 1.4V
					Lighting switch flash-to-pass	 1.3V
					Lighting switch 2ND	 1.3V
					Front wiper switch INT	 1.3V
					Front wiper switch HI	 1.3V
					Pressed	0 V
98 (G/R)	Ground	Hazard switch	Input	Hazard switch	Not pressed	 1.1V

A
B
C
D
E
F
G
H
I
J
L
M
N
O
P

RF

BCM (BODY CONTROL MODULE)

< ECU DIAGNOSIS >

Terminal No. (Wire color)		Description		Condition	Value (Approx.)	
(+)	(-)	Signal name	Input/ Output			
99 (L/Y)	Ground	Electronic steering column lock CPU communication	Input/ Output	Electronic steer- ing column lock	LOCK status	Battery voltage
					LOCK or UNLOCK	<p style="text-align: right; font-size: small;">JMKIA0066GB</p>
					For 15 seconds after UN- LOCK	Battery voltage
					15 seconds or later after UNLOCK	0V
103 (V)	Ground	Trunk lid opening	Output	Trunk lid	Open (trunk lid opener ac- tuator is activated)	Battery voltage
					Close (trunk lid opener ac- tuator is not activated)	0V
110 (V/W)	Ground	Trunk room lamp	Output	Trunk room lamp	ON	0V
					OFF	Battery voltage
114 (B)	Ground	Trunk room antenna 1 (-)	Output	Ignition switch OFF	When Intelligent Key is in the passenger compart- ment	<p style="text-align: right; font-size: small;">JMKIA0062GB</p>
					When Intelligent Key is not in the passenger compart- ment	<p style="text-align: right; font-size: small;">JMKIA0063GB</p>

BCM (BODY CONTROL MODULE)

< ECU DIAGNOSIS >

Terminal No. (Wire color)		Description		Condition	Value (Approx.)
		Signal name	Input/ Output		
(+)	(-)				
115 (W)	Ground	Trunk room antenna 1 (+)	Output	Ignition switch OFF	<p style="text-align: right; font-size: small;">JMKIA0062GB</p>
				When Intelligent Key is not in the passenger compart- ment	<p style="text-align: right; font-size: small;">JMKIA0063GB</p>
118 (L/O)	Ground	Rear bumper anten- na (-)	Output	When the trunk lid request switch is operated with ignition switch OFF	<p style="text-align: right; font-size: small;">JMKIA0062GB</p>
				When Intelligent Key is not in the antenna detection area	<p style="text-align: right; font-size: small;">JMKIA0063GB</p>
119 (BR/ W)	Ground	Rear bumper anten- na (+)	Output	When the trunk lid request switch is operated with ignition switch OFF	<p style="text-align: right; font-size: small;">JMKIA0062GB</p>
				When Intelligent Key is not in the antenna detection area	<p style="text-align: right; font-size: small;">JMKIA0063GB</p>

A
B
C
D
E
F
G
H
I
J
K
L
M
N
O
P

RF

BCM (BODY CONTROL MODULE)

< ECU DIAGNOSIS >

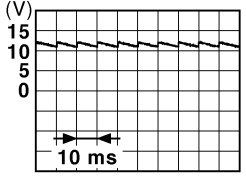
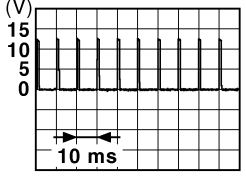
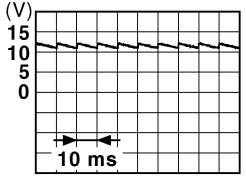
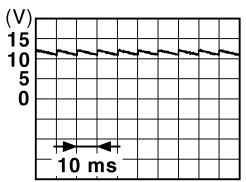
Terminal No. (Wire color)		Description		Condition	Value (Approx.)	
(+)	(-)	Signal name	Input/ Output			
127 (BR/ W)	Ground	Ignition relay (IPDM E/R) control	Output	Ignition switch	OFF or ACC	Battery voltage
					ON	0V
130 (Y/G)	Ground	Trunk room lamp switch	Input	Trunk room lamp switch	OFF (trunk is closed)	 <p style="text-align: right; margin-right: 50px;">JPMIA0011GB</p> <p style="text-align: center;">11.8V</p>
					ON (trunk is open)	0V
132 (R)	Ground	Start signal	Output	Ignition switch ON	When selector lever is in P or N position and the brake peddle is not depressed	0V
					When selector lever is in P or N position and the brake peddle is depressed	Battery voltage
141 (G/R)	Ground	Trunk request switch	Input	Trunk request switch	ON (pressed)	0V
					OFF (not pressed)	 <p style="text-align: right; margin-right: 50px;">JPMIA0016GB</p> <p style="text-align: center;">1.0V</p>
144 (GR)	Ground	Request switch buzz- er	Output	Request switch buzzer	Sounding	0V
					Not sounding	Battery voltage
147 (L/R)	Ground	Trunk lid opener switch	Input	Trunk lid opener switch	Pressed	0V
					Not pressed	 <p style="text-align: right; margin-right: 50px;">JPMIA0011GB</p> <p style="text-align: center;">11.8V</p>
148 (R/W)	Ground	Rear door RH switch	Input	Rear door RH switch	OFF (when rear door RH closes)	 <p style="text-align: right; margin-right: 50px;">JPMIA0011GB</p> <p style="text-align: center;">11.8V</p>
					ON (when rear door RH opens)	0V

BCM (BODY CONTROL MODULE)

< ECU DIAGNOSIS >

Terminal No. (Wire color)		Description		Condition	Value (Approx.)
		Signal name	Input/ Output		
(+)	(-)				
149 (R/B)	Ground	Rear door LH switch	Input	Rear door LH switch	OFF (when rear door LH closes)
				ON (when rear door LH opens)	0V

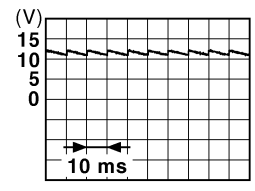

JPMIA0011GB

*: With LH and RH front window anti-pinch system

A
B
C
D
E
F
G
H
I
J
L
M
N
O
P

RF

SUNROOF MOTOR ASSEMBLY

< ECU DIAGNOSIS >

SUNROOF MOTOR ASSEMBLY

Reference Value

INFOID:000000003071494

TERMINAL LAYOUT

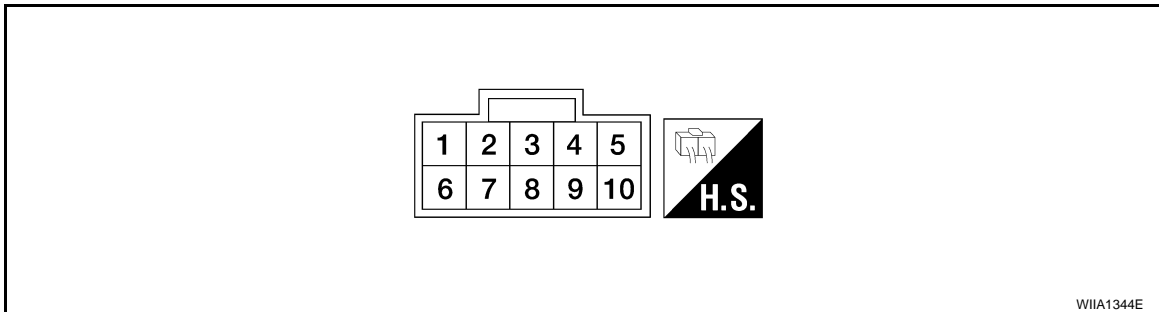

PHYSICAL VALUES

Terminal No. (Wire color)		Description		Condition	Voltage (V) (Approx.)
+	-	Signal name	Input/ Output		
1 (G)	Ground	Sunroof close switch (BIT 1) signal	Input	Sunroof switch in following position • TILT UP • SLIDE CLOSE	0
				Other than above	Battery voltage
2 (B)	Ground	Ground	—	—	0
5 (Y)	Ground	Sunroof open switch (BIT 0) signal	Input	Sunroof switch in following position • TILT DOWN • SLIDE OPEN	0
				Other than above	Battery voltage
7 (R/Y)	Ground	Sunroof power supply	Input	—	Battery voltage
8 (L/B)	Ground	Vehicle speed signal (2-pulse)	Input	Speedometer operated [When vehicle speed is approx.40km/ h (25MPH)]	
9 (L/W)	Ground	RAP signal	Input	Ignition switch ON	Battery voltage
				Within 45 second after ignition switch is turned to OFF.	Battery voltage
				When driver side or passenger side door is opened during retained power operation.	0
10 (R)	Ground	Ground	—	—	0

SUNROOF MOTOR ASSEMBLY

< ECU DIAGNOSIS >

Wiring Diagram

INFOID:000000003071495

SUNROOF

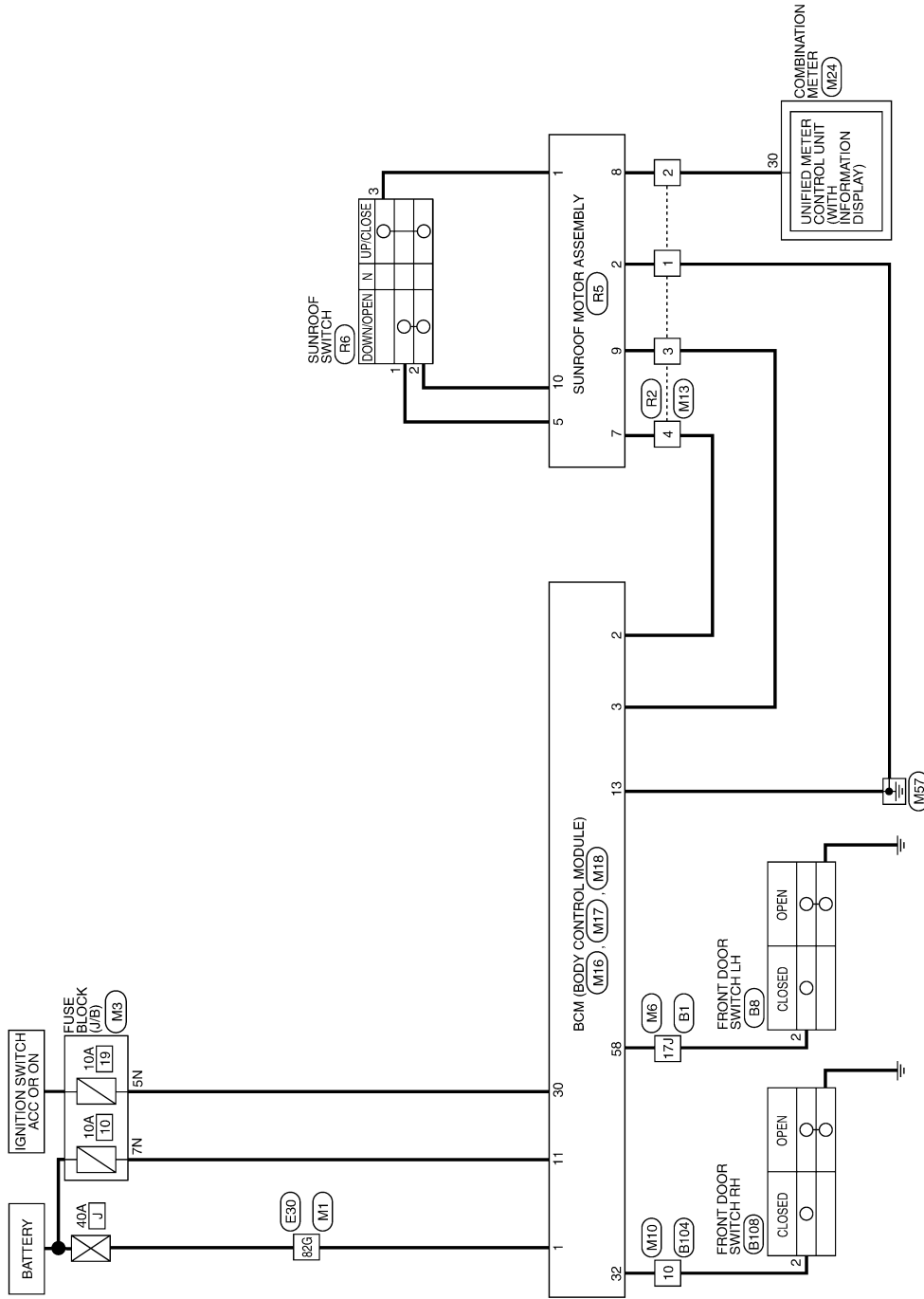

A
B
C
D
E
F
G
H
I
J
L
M
N
O
P

RF

AWKWA0207GI

SUNROOF MOTOR ASSEMBLY

< ECU DIAGNOSIS >

SUNROOF CONNECTORS

Connector No.	M1
Connector Name	WIRE TO WIRE
Connector Color	WHITE

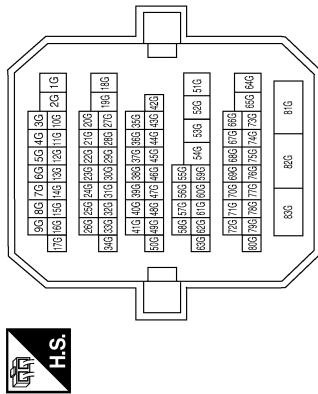

Terminal No.	Color of wire	Signal Name
82G	W/B	-

Connector No.	M3
Connector Name	FUSE BLOCK (J/B)
Connector Color	WHITE

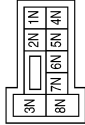

Terminal No.	Color of wire	Signal Name
5N	V/Y	-
7N	Y/R	-

Connector No.	M10
Connector Name	WIRE TO WIRE
Connector Color	BROWN

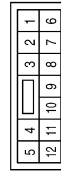

Terminal No.	Color of wire	Signal Name
10	R/B	-

Connector No.	M6
Connector Name	WIRE TO WIRE
Connector Color	WHITE

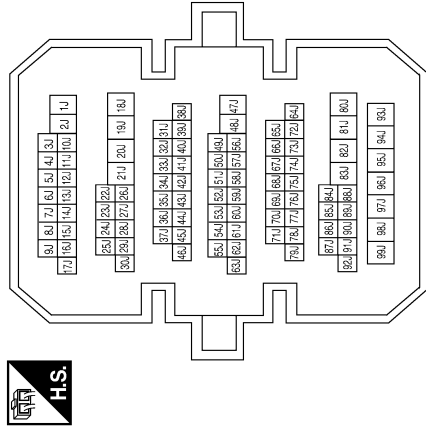

Terminal No.	Color of wire	Signal Name
17J	SB	-

Connector No.	M16
Connector Name	BCM (BODY CONTROL MODULE)
Connector Color	BLACK



Terminal No.	Color of wire	Signal Name
1	W/B	BAT_POWER_F/L
2	R/Y	POWER WINDOW POWER SUPPLY (BAT)
3	L/W	POWER WINDOW POWER SUPPLY (RAP)

ALKIA0017GB

SUNROOF MOTOR ASSEMBLY

< ECU DIAGNOSIS >

Connector No.	M17
Connector Name	BCM (BODY CONTROL MODULE)
Connector Color	WHITE

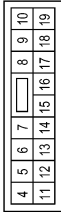

Terminal No.	Color of wire	Signal Name
11	Y/R	BAT_BCM_FUSE
13	B	GND1

Connector No.	M18
Connector Name	BCM (BODY CONTROL MODULE)
Connector Color	GREEN

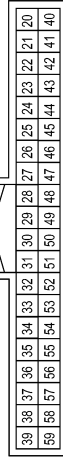

Terminal No.	Color of wire	Signal Name
30	V/Y	ACC_F/B
32	R/B	AS_DOOR_SW
58	SB	DR_DOOR_SW

Connector No.	M24
Connector Name	COMBINATION METER
Connector Color	WHITE

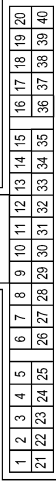

Terminal No.	Color of wire	Signal Name
30	L/B	SPEED (2P)

Connector No.	E30
Connector Name	WIRE TO WIRE
Connector Color	WHITE

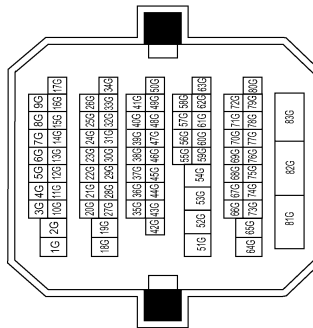

Terminal No.	Color of wire	Signal Name
82G	W/B	-

Connector No.	B1
Connector Name	WIRE TO WIRE
Connector Color	WHITE

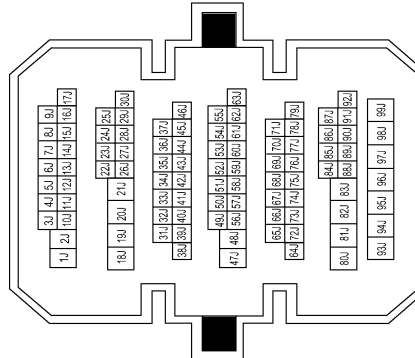

Terminal No.	Color of wire	Signal Name
17J	SB	-

Connector No.	B8
Connector Name	FRONT DOOR SWITCH LH
Connector Color	WHITE

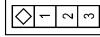

Terminal No.	Color of wire	Signal Name
1		
2	SB	DOOR SW (DR)

ALKIA0257GB

A
B
C
D
E
F
G
H
I
J
K
L
M
N
O
P

SUNROOF MOTOR ASSEMBLY

< ECU DIAGNOSIS >

Connector No.	R2
Connector Name	WIRE TO WIRE
Connector Color	WHITE

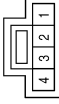

Terminal No.	Color of wire	Signal Name
1	B	-
2	L/B	-
3	L/W	-
4	R/Y	-

Connector No.	B108
Connector Name	FRONT DOOR SWITCH RH
Connector Color	WHITE

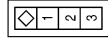

Terminal No.	Color of wire	Signal Name
2	R/B	DOOR SW (AS)

Connector No.	B104
Connector Name	WIRE TO WIRE
Connector Color	BROWN



Terminal No.	Color of wire	Signal Name
10	R/B	-

Connector No.	R6
Connector Name	SUNROOF SWITCH
Connector Color	WHITE



Terminal No.	Color of wire	Signal Name
1	Y	+ DOWN_OPEN
2	R	GND
3	G	+ UP_CLOSE

Connector No.	R5
Connector Name	SUNROOF MOTOR ASSEMBLY
Connector Color	WHITE

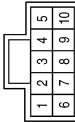

Terminal No.	Color of wire	Signal Name
1	G	CLOSE_T_UP
2	B	GND
5	Y	OPEN_T_DOWN
7	R/Y	+B
8	L/B	SPEED (2P)
9	L/W	+ IGN
10	R	GROUND

ALKIA0236GB

SUNROOF DOES NOT OPERATE PROPERLY

< SYMPTOM DIAGNOSIS >

SYMPTOM DIAGNOSIS

SUNROOF DOES NOT OPERATE PROPERLY

Diagnosis Procedure

INFOID:000000003292968

1. CHECK BCM POWER SUPPLY AND GROUND CIRCUITS

Check BCM power supply and ground circuits. Refer to [BCS-41, "Diagnosis Procedure"](#).

Is the inspection result normal?

YES >> GO TO 2.

NO >> Repair or replace malfunctioning parts.

2. CHECK SUNROOF MOTOR ASSEMBLY POWER SUPPLY AND GROUND CIRCUIT

Check sunroof motor assembly power supply and ground circuit. Refer to [RF-11, "SUNROOF MOTOR ASSEMBLY : Diagnosis Procedure"](#).

Is the inspection result normal?

YES >> GO TO 3.

NO >> Repair or replace malfunctioning parts.

3. CHECK SUNROOF SWITCH CIRCUIT

Check sunroof switch circuit. Refer to [RF-11, "SUNROOF MOTOR ASSEMBLY : Diagnosis Procedure"](#).

Is the inspection result normal?

YES >> Check intermittent incident. Refer to [GI-42, "Intermittent Incident"](#).

NO >> Repair or replace malfunctioning parts.

A
B
C
D
E
F
G
H
I
J
L
M
N
O
P

RF

AUTO OPERATION DOES NOT OPERATE

< SYMPTOM DIAGNOSIS >

AUTO OPERATION DOES NOT OPERATE

Diagnosis Procedure

INFOID:000000003292969

1. PERFORM INITIALIZATION PROCEDURE

Perform initialization procedure. Refer to [RF-6, "ADDITIONAL SERVICE WHEN REPLACING CONTROL UNIT : Special Repair Requirement"](#).

Is the inspection result normal?

YES >> Inspection End.

NO >> Check intermittent incident. Refer to [GI-42, "Intermittent Incident"](#).

DOES NOT STOP FULLY-OPEN OR FULLY-CLOSED POSITION

< SYMPTOM DIAGNOSIS >

DOES NOT STOP FULLY-OPEN OR FULLY-CLOSED POSITION

Diagnosis Procedure

INFOID:000000003292970

1. PERFORM INITIALIZATION PROCEDURE

Perform initialization procedure. Refer to [RF-6, "ADDITIONAL SERVICE WHEN REPLACING CONTROL UNIT : Special Repair Requirement"](#).

Is the inspection result normal?

YES >> Inspection End.

NO >> Check intermittent incident. Refer to [GI-42, "Intermittent Incident"](#).

A
B
C
D
E
F
G
H
I
J
RF
L
M
N
O
P

RETAINED POWER OPERATION DOES NOT OPERATE PROPERLY

< SYMPTOM DIAGNOSIS >

RETAINED POWER OPERATION DOES NOT OPERATE PROPERLY

Diagnosis Procedure

INFOID:000000003292971

1. CHECK FRONT DOOR SWITCH

Check front door switch. Refer to [DLK-52, "Component Function Check"](#).

Is the inspection result normal?

- YES >> Check intermittent incident. Refer to [GI-42, "Intermittent Incident"](#).
- NO >> Repair or replace malfunctioning parts.

SUNROOF DOES NOT OPERATE ANTI-PINCH FUNCTION

< SYMPTOM DIAGNOSIS >

SUNROOF DOES NOT OPERATE ANTI-PINCH FUNCTION

Diagnosis Procedure

INFOID:000000003292972

1. PERFORM INITIALIZATION PROCEDURE

Perform initialization procedure. Refer to [RF-6, "ADDITIONAL SERVICE WHEN REPLACING CONTROL UNIT : Special Repair Requirement"](#).

Is the inspection result normal?

YES >> Inspection End.

NO >> Check intermittent incident. Refer to [GI-42, "Intermittent Incident"](#).

A
B
C
D
E
F
G
H
I
J
RF
L
M
N
O
P

SQUEAK AND RATTLE TROUBLE DIAGNOSES

< SYMPTOM DIAGNOSIS >

SQUEAK AND RATTLE TROUBLE DIAGNOSES

Work Flow

INFOID:000000003071501

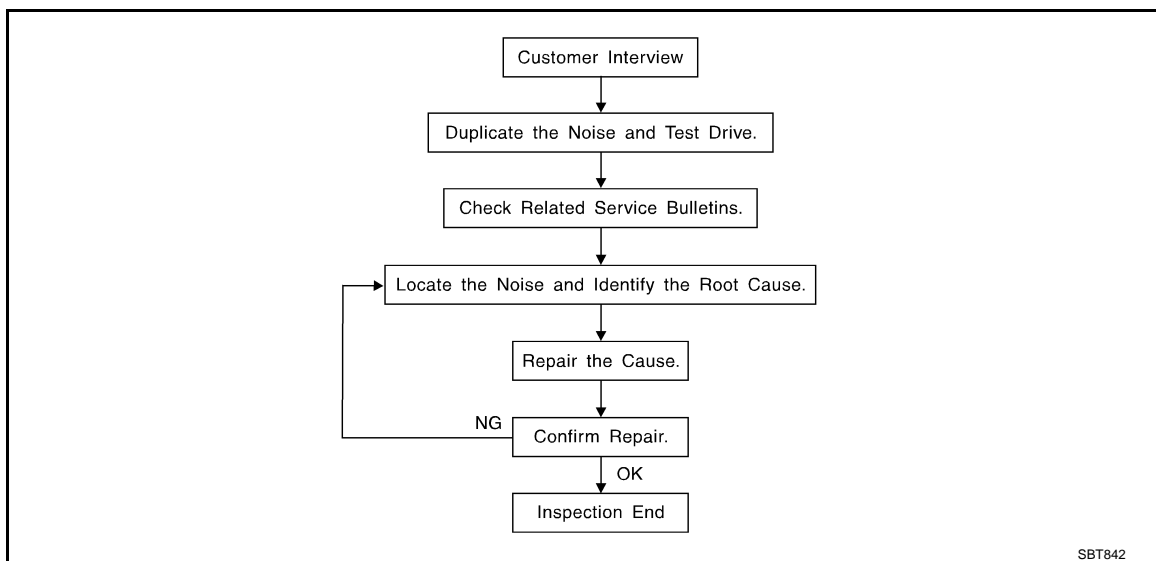

CUSTOMER INTERVIEW

Interview the customer if possible, to determine the conditions that exist when the noise occurs. Use the Diagnostic Worksheet during the interview to document the facts and conditions when the noise occurs and any customer's comments; refer to [RF-56, "Diagnostic Worksheet"](#). This information is necessary to duplicate the conditions that exist when the noise occurs.

- The customer may not be able to provide a detailed description or the location of the noise. Attempt to obtain all the facts and conditions that exist when the noise occurs (or does not occur).
- If there is more than one noise in the vehicle, be sure to diagnose and repair the noise that the customer is concerned about. This can be accomplished by test driving the vehicle with the customer.
- After identifying the type of noise, isolate the noise in terms of its characteristics. The noise characteristics are provided so the customer, service adviser and technician are all speaking the same language when defining the noise.
- Squeak —(Like tennis shoes on a clean floor)
Squeak characteristics include the light contact/fast movement/brought on by road conditions/hard surfaces=higher pitch noise/softer surfaces=lower pitch noises/edge to surface=chirping
- Creak—(Like walking on an old wooden floor)
Creak characteristics include firm contact/slow movement/twisting with a rotational movement/pitch dependent on materials/often brought on by activity.
- Rattle—(Like shaking a baby rattle)
Rattle characteristics include the fast repeated contact/vibration or similar movement/loose parts/missing clip or fastener/incorrect clearance.
- Knock —(Like a knock on a door)
Knock characteristics include hollow sounding/sometimes repeating/often brought on by driver action.
- Tick—(Like a clock second hand)
Tick characteristics include gentle contacting of light materials/loose components/can be caused by driver action or road conditions.
- Thump—(Heavy, muffled knock noise)
Thump characteristics include softer knock/dead sound often brought on by activity.
- Buzz—(Like a bumble bee)
Buzz characteristics include high frequency rattle/firm contact.
- Often the degree of acceptable noise level will vary depending upon the person. A noise that you may judge as acceptable may be very irritating to the customer.
- Weather conditions, especially humidity and temperature, may have a great effect on noise level.

DUPLICATE THE NOISE AND TEST DRIVE

If possible, drive the vehicle with the customer until the noise is duplicated. Note any additional information on the Diagnostic Worksheet regarding the conditions or location of the noise. This information can be used to duplicate the same conditions when you confirm the repair.

SQUEAK AND RATTLE TROUBLE DIAGNOSES

< SYMPTOM DIAGNOSIS >

If the noise can be duplicated easily during the test drive, to help identify the source of the noise, try to duplicate the noise with the vehicle stopped by doing one or all of the following:

- 1) Close a door.
 - 2) Tap or push/pull around the area where the noise appears to be coming from.
 - 3) Rev the engine.
 - 4) Use a floor jack to recreate vehicle "twist".
 - 5) At idle, apply engine load (electrical load, half-clutch on M/T model, drive position on A/T model).
 - 6) Raise the vehicle on a hoist and hit a tire with a rubber hammer.
- Drive the vehicle and attempt to duplicate the conditions the customer states exist when the noise occurs.
 - If it is difficult to duplicate the noise, drive the vehicle slowly on an undulating or rough road to stress the vehicle body.

CHECK RELATED SERVICE BULLETINS

After verifying the customer concern or symptom, check ASIST for Technical Service Bulletins (TSBs) related to that concern or symptom.

If a TSB relates to the symptom, follow the procedure to repair the noise.

LOCATE THE NOISE AND IDENTIFY THE ROOT CAUSE

1. Narrow down the noise to a general area. To help pinpoint the source of the noise, use a listening tool (Chassis Ear: J-39570, Engine Ear and mechanics stethoscope).
2. Narrow down the noise to a more specific area and identify the cause of the noise by:
 - removing the components in the area that you suspect the noise is coming from.
Do not use too much force when removing clips and fasteners, otherwise clips and fastener can be broken or lost during the repair, resulting in the creation of new noise.
 - tapping or pushing/pulling the component that you suspect is causing the noise.
Do not tap or push/pull the component with excessive force, otherwise the noise will be eliminated only temporarily.
 - feeling for a vibration with your hand by touching the component(s) that you suspect is (are) causing the noise.
 - placing a piece of paper between components that you suspect are causing the noise.
 - looking for loose components and contact marks.
Refer to [RF-54. "Inspection Procedure"](#).

REPAIR THE CAUSE

- If the cause is a loose component, tighten the component securely.
- If the cause is insufficient clearance between components:
 - separate components by repositioning or loosening and retightening the component, if possible.
 - insulate components with a suitable insulator such as urethane pads, foam blocks, felt cloth tape or urethane tape. A Nissan Squeak and Rattle Kit (J-43980) is available through your authorized Nissan Parts Department.

CAUTION:

Do not use excessive force as many components are constructed of plastic and may be damaged.

NOTE:

Always check with the Parts Department for the latest parts information.

The following materials are contained in the Nissan Squeak and Rattle Kit (J-43980). Each item can be ordered separately as needed.

URETHANE PADS [1.5 mm (0.059 in) thick]

Insulates connectors, harness, etc.

76268-9E005: 100 × 135 mm (3.94 × 5.31 in)/76884-71L01: 60 × 85 mm (2.36 × 3.35 in)/76884-71L02: 15 × 25 mm (0.59 × 0.98 in)

INSULATOR (Foam blocks)

Insulates components from contact. Can be used to fill space behind a panel.

73982-9E000: 45 mm (1.77 in) thick, 50 × 50 mm (1.97 × 1.97 in)/73982-

50Y00: 10 mm (0.39 in) thick, 50 × 50 mm (1.97 × 1.97 in)

INSULATOR (Light foam block)

80845-71L00: 30 mm (1.18 in) thick, 30 × 50 mm (1.18 × 1.97 in)

FELT CLOTHTAPE

Used to insulate where movement does not occur. Ideal for instrument panel applications.

68370-4B000: 15 × 25 mm (0.59 × 0.98 in) pad/68239-13E00: 5 mm (0.20 in) wide tape roll

The following materials, not found in the kit, can also be used to repair squeaks and rattles.

UHMW (TEFLON) TAPE

SQUEAK AND RATTLE TROUBLE DIAGNOSES

< SYMPTOM DIAGNOSIS >

Insulates where slight movement is present. Ideal for instrument panel applications.

SILICONE GREASE

Used in place of UHMW tape that will be visible or not fit. Will only last a few months.

SILICONE SPRAY

Use when grease cannot be applied.

DUCT TAPE

Use to eliminate movement.

CONFIRM THE REPAIR

Confirm that the cause of a noise is repaired by test driving the vehicle. Operate the vehicle under the same conditions as when the noise originally occurred. Refer to the notes on the Diagnostic Worksheet.

Inspection Procedure

INFOID:000000003071502

Refer to Table of Contents for specific component removal and installation information.

INSTRUMENT PANEL

Most incidents are caused by contact and movement between:

1. The cluster lid A and instrument panel
2. Acrylic lens and combination meter housing
3. Instrument panel to front pillar garnish
4. Instrument panel to windshield
5. Instrument panel mounting pins
6. Wiring harnesses behind the combination meter
7. A/C defroster duct and duct joint

These incidents can usually be located by tapping or moving the components to duplicate the noise or by pressing on the components while driving to stop the noise. Most of these incidents can be repaired by applying felt cloth tape or silicon spray (in hard to reach areas). Urethane pads can be used to insulate wiring harness.

CAUTION:

Do not use silicone spray to isolate a squeak or rattle. If you saturate the area with silicone, you will not be able to recheck the repair.

CENTER CONSOLE

Components to pay attention to include:

1. Shifter assembly cover to finisher
2. A/C control unit and cluster lid C
3. Wiring harnesses behind audio and A/C control unit

The instrument panel repair and isolation procedures also apply to the center console.

DOORS

Pay attention to the:

1. Finisher and inner panel making a slapping noise
2. Inside handle escutcheon to door finisher
3. Wiring harnesses tapping
4. Door striker out of alignment causing a popping noise on starts and stops

Tapping or moving the components or pressing on them while driving to duplicate the conditions can isolate many of these incidents. You can usually insulate the areas with felt cloth tape or insulator foam blocks from the Nissan Squeak and Rattle Kit (J-43980) to repair the noise.

TRUNK

Trunk noises are often caused by a loose jack or loose items put into the trunk by the owner.

In addition look for:

1. Trunk lid dumpers out of adjustment
2. Trunk lid striker out of adjustment
3. The trunk lid torsion bars knocking together
4. A loose license plate or bracket

SQUEAK AND RATTLE TROUBLE DIAGNOSES

< SYMPTOM DIAGNOSIS >

Most of these incidents can be repaired by adjusting, securing or insulating the item(s) or component(s) causing the noise.

SUNROOF/HEADLINING

Noises in the sunroof/headlining area can often be traced to one of the following:

1. Sunroof lid, rail, linkage or seals making a rattle or light knocking noise
2. Sunvisor shaft shaking in the holder
3. Front or rear windshield touching headlining and squeaking

Again, pressing on the components to stop the noise while duplicating the conditions can isolate most of these incidents. Repairs usually consist of insulating with felt cloth tape.

SEATS

When isolating seat noise it's important to note the position the seat is in and the load placed on the seat when the noise is present. These conditions should be duplicated when verifying and isolating the cause of the noise.

Cause of seat noise include:

1. Headrest rods and holder
2. A squeak between the seat pad cushion and frame
3. The rear seatback lock and bracket

These noises can be isolated by moving or pressing on the suspected components while duplicating the conditions under which the noise occurs. Most of these incidents can be repaired by repositioning the component or applying urethane tape to the contact area.

UNDERHOOD

Some interior noise may be caused by components under the hood or on the engine wall. The noise is then transmitted into the passenger compartment.

Causes of transmitted underhood noise include:

1. Any component mounted to the engine wall
2. Components that pass through the engine wall
3. Engine wall mounts and connectors
4. Loose radiator mounting pins
5. Hood bumpers out of adjustment
6. Hood striker out of adjustment

These noises can be difficult to isolate since they cannot be reached from the interior of the vehicle. The best method is to secure, move or insulate one component at a time and test drive the vehicle. Also, engine RPM or load can be changed to isolate the noise. Repairs can usually be made by moving, adjusting, securing, or insulating the component causing the noise.

A
B
C
D
E
F
G
H
I
J
RF
L
M
N
O
P

SQUEAK AND RATTLE TROUBLE DIAGNOSES

< SYMPTOM DIAGNOSIS >

Diagnostic Worksheet

INFOID:00000003071503

Dear Customer:

We are concerned about your satisfaction with your vehicle. Repairing a squeak or rattle sometimes can be very difficult. To help us fix your vehicle right the first time, please take a moment to note the area of the vehicle where the squeak or rattle occurs and under what conditions. You may be asked to take a test drive with a service advisor or technician to ensure we confirm the noise you are hearing.

SQUEAK & RATTLE DIAGNOSTIC WORKSHEET

I. WHERE DOES THE NOISE COME FROM? (circle the area of the vehicle)

The illustrations are for reference only, and may not reflect the actual configuration of your vehicle.

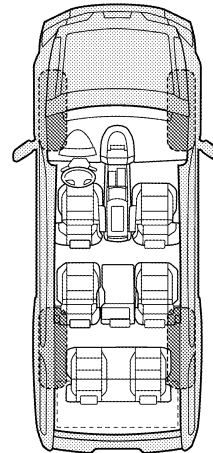
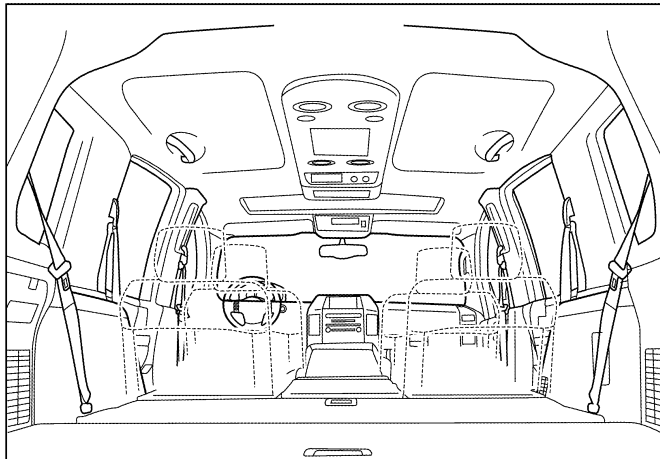
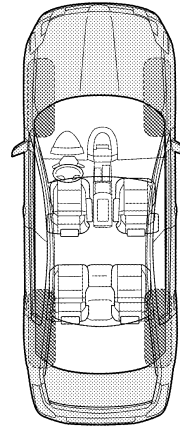
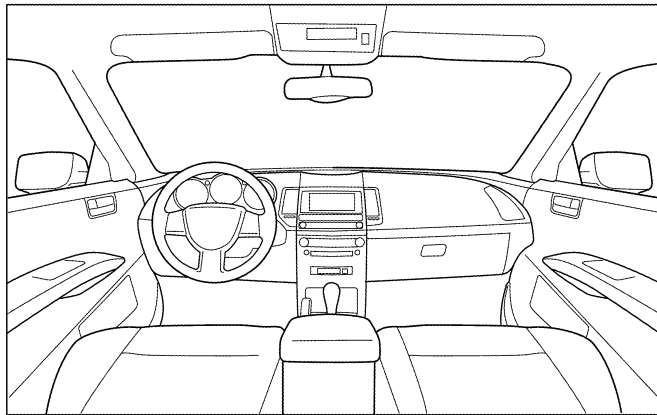

Continue to page 2 of the worksheet and briefly describe the location of the noise or rattle. In addition, please indicate the conditions which are present when the noise occurs.

SQUEAK AND RATTLE TROUBLE DIAGNOSES

< SYMPTOM DIAGNOSIS >

SQUEAK & RATTLE DIAGNOSTIC WORKSHEET - page 2

Briefly describe the location where the noise occurs:

II. WHEN DOES IT OCCUR? (please check the boxes that apply)

- | | |
|---|--|
| <input type="checkbox"/> Anytime | <input type="checkbox"/> After sitting out in the rain |
| <input type="checkbox"/> 1st time in the morning | <input type="checkbox"/> When it is raining or wet |
| <input type="checkbox"/> Only when it is cold outside | <input type="checkbox"/> Dry or dusty conditions |
| <input type="checkbox"/> Only when it is hot outside | <input type="checkbox"/> Other: |

III. WHEN DRIVING:

- Through driveways
- Over rough roads
- Over speed bumps
- Only about ____ mph
- On acceleration
- Coming to a stop
- On turns: left, right or either (circle)
- With passengers or cargo
- Other: _____
- After driving ____ miles or ____ minutes

IV. WHAT TYPE OF NOISE

- Squeak (like tennis shoes on a clean floor)
- Creak (like walking on an old wooden floor)
- Rattle (like shaking a baby rattle)
- Knock (like a knock at the door)
- Tick (like a clock second hand)
- Thump (heavy muffled knock noise)
- Buzz (like a bumble bee)

TO BE COMPLETED BY DEALERSHIP PERSONNEL

Test Drive Notes:

	YES	NO	Initials of person performing
Vehicle test driven with customer	<input type="checkbox"/>	<input type="checkbox"/>	_____
- Noise verified on test drive	<input type="checkbox"/>	<input type="checkbox"/>	_____
- Noise source located and repaired	<input type="checkbox"/>	<input type="checkbox"/>	_____
- Follow up test drive performed to confirm repair	<input type="checkbox"/>	<input type="checkbox"/>	_____

VIN: _____ Customer Name _____

W.O.# _____ Date: _____

This form must be attached to Work Order

LAI A0071E

A
B
C
D
E
F
G
H
I
J
RF
L
M
N
O
P

PRECAUTIONS

< PRECAUTION >

PRECAUTION

PRECAUTIONS

Supplemental Restraint System (SRS) "AIR BAG" and "SEAT BELT PRE-TENSIONER"

INFOID:000000003071504

The Supplemental Restraint System such as "AIR BAG" and "SEAT BELT PRE-TENSIONER", used along with a front seat belt, helps to reduce the risk or severity of injury to the driver and front passenger for certain types of collision. This system includes seat belt switch inputs and dual stage front air bag modules. The SRS system uses the seat belt switches to determine the front air bag deployment, and may only deploy one front air bag, depending on the severity of a collision and whether the front occupants are belted or unbelted. Information necessary to service the system safely is included in the SR and SB section of this Service Manual.

WARNING:

- To avoid rendering the SRS inoperative, which could increase the risk of personal injury or death in the event of a collision which would result in air bag inflation, all maintenance must be performed by an authorized NISSAN/INFINITI dealer.
- Improper maintenance, including incorrect removal and installation of the SRS, can lead to personal injury caused by unintentional activation of the system. For removal of Spiral Cable and Air Bag Module, see the SR section.
- Do not use electrical test equipment on any circuit related to the SRS unless instructed to in this Service Manual. SRS wiring harnesses can be identified by yellow and/or orange harnesses or harness connectors.

Precautions

INFOID:000000003071505

- After removing and installing any opening/closing parts, make sure to perform all adjustments for proper operation.
- Check the lubrication level, damage, and wear of each part. If necessary, grease or replace it.
- When removing or disassembling any part, be careful not to damage or deform it. Protect parts which may get in the way with cloth.
- When removing parts with a screw driver or other tool, protect parts by wrapping them with vinyl or tape.
- Keep removed parts protected with cloth.
- If a clip is deformed or damaged, replace it.
- If an unreuseable part is removed, replace it with a new one.
- Tighten bolts and nuts firmly to the specified torque.
- After re-assembly has been completed, make sure each part functions correctly.
- Remove stains in the following manner:

Water-Soluble stains	Oil stains
Dip a cloth in warm water, and squeeze tightly. After wiping the stain, wipe with a soft dry cloth.	Dissolve a synthetic detergent in warm water (density of 2 to 3% or less), dip the cloth, then clean off the stain with the cloth. Next, dip the cloth in fresh water, then squeeze tightly. Clean off detergent completely, then wipe entire area with a soft dry cloth.
Do not use any organic solvent, such as a thinner or benzine to remove stains	

PREPARATION

< PREPARATION >

PREPARATION

PREPARATION

Special Service Tools

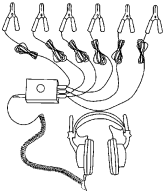
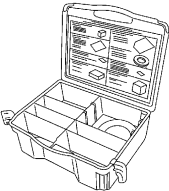

INFOID:000000003071506

The actual shapes of Kent-Moore tools may differ from those of special service tools illustrated here.

Tool number (Kent-Moore No.) Tool name	Description
(J-39570) Chassis ear  SIIA0993E	Locating the noise
(J-43980) NISSAN Squeak and Rattle Kit  SIIA0994E	Repairing the cause of noise

Commercial Service Tools

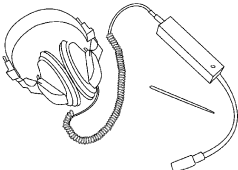
INFOID:000000003071507

Tool name (Kent-Moore No.)	Description
Engine ear (J-39565)  SIIA0995E	Locating the noise
Power tools  PIIB1407E	Loosening bolts, nuts and screws

A
B
C
D
E
F
G
H
I
J
L
M
N
O
P

RF

SUNROOF UNIT ASSEMBLY

< ON-VEHICLE REPAIR >

ON-VEHICLE REPAIR

SUNROOF UNIT ASSEMBLY

Inspection

INFOID:000000003071508

WIND DEFLECTOR

1. Open glass lid assembly fully.
2. Visually check for proper installation, damaged/deteriorated components, or foreign objects within mechanism. Correct as required for smooth operation.
3. Check for grease at the wind deflector arm (1) and pivot areas. If necessary, apply a sufficient amount of grease for non-binding operation.
←:Vehicle front

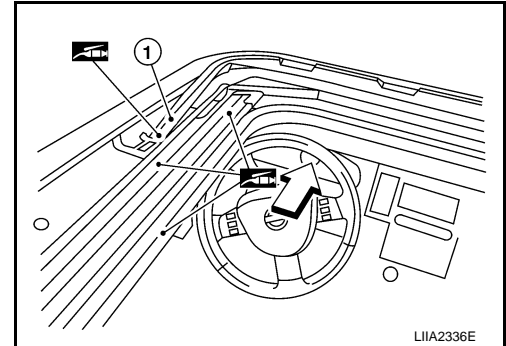

4. Check that the wind deflector (1) moves freely within the sunroof unit assembly while manually pressing down and releasing. If a malfunction is detected, remove the sunroof unit assembly and visually inspect; refer to [RF-60, "Inspection"](#). If damage is found, replace either wind deflector (1) or sunroof unit assembly as required.
←:Vehicle front

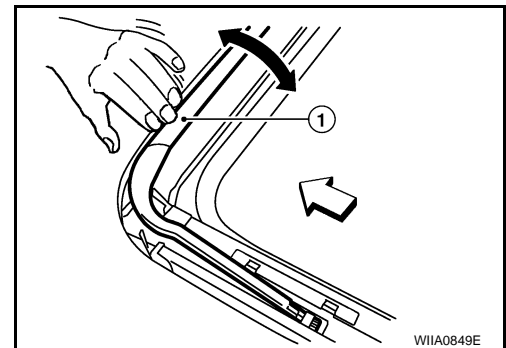

LINK AND WIRE ASSEMBLY

NOTE:

Before replacing a suspect part, make sure it is the source of noise being experienced.

1. Check link to determine if coating film has peeled off excessively enough that substrate is visible. Check also to determine if link is the source of noise. Replace as necessary.
2. Visually check to determine if a sufficient amount of grease has been applied to wire or rail groove. If not, add grease as required.
3. Check wire for any damage or deterioration. If any damage is found, replace sunroof unit assembly.

WEATHERSTRIP

1. Visually check weatherstrip for damage, deterioration, or deformation.
 - Open glass lid assembly partially to inspect front edge of weatherstrip.
 - Tilt up glass lid assembly fully to inspect sides and rear edge of weatherstrip.If any area of the weatherstrip is found to be damaged, replace the glass lid assembly. Refer to [RF-64, "Removal and Installation"](#).
2. Check for leakage around glass lid assembly.
 - Close glass lid assembly.
 - Pour water around surface to determine area of concern.
 - For gaps or misalignment, adjust glass lid assembly to specifications. Refer to [RF-60, "Inspection"](#).
 - For damaged sealing surfaces, either replace glass lid assembly [RF-64, "Removal and Installation"](#), or repair the panel [BRM-28, "High Strength Steel \(HSS\)"](#).

DRAIN HOSES

SUNROOF UNIT ASSEMBLY

< ON-VEHICLE REPAIR >

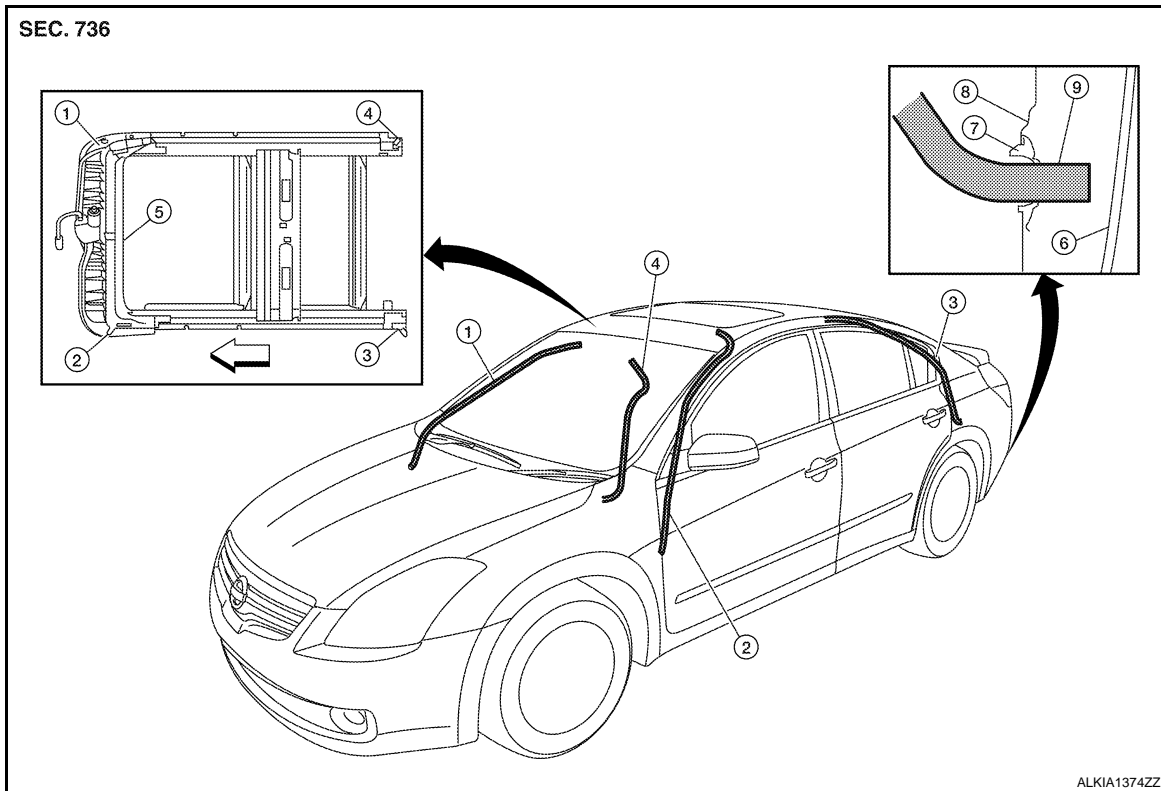

- | | | |
|------------------------|--------------------------|-----------------------|
| 1. Drain hose front RH | 2. Drain hose front LH | 3. Drain hose rear LH |
| 4. Drain hose rear RH | 5. Sunroof unit assembly | 6. Fascia |
| 7. Seal | 8. Fender | 9. Drain hose |
- ← Vehicle front

1. Remove the headlining. Refer to [INT-18. "Removal and Installation"](#).
2. Visually check drain hoses for:
 - Proper connection at sunroof unit assembly drain hose connector(s).
 - Damage, pinch, cracks, deterioration.
 - Proper fastening and routing on body panels.
3. Pour water through drain hoses to determine watertight performance.
If damaged or leaking portions in any drain hose is found, replace entire drain hose as necessary.

ADJUSTMENT

CAUTION:

- Always work with a helper.
- Handle glass lid assembly with care to prevent damage.

NOTE:

- For easier and more accurate installation, always mark each point before removal.
- After any adjustment, check sunroof operation and glass lid assembly alignment.

A
B
C
D
E
F
G
H
I
J
RF
L
M
N
O
P

SUNROOF UNIT ASSEMBLY

< ON-VEHICLE REPAIR >

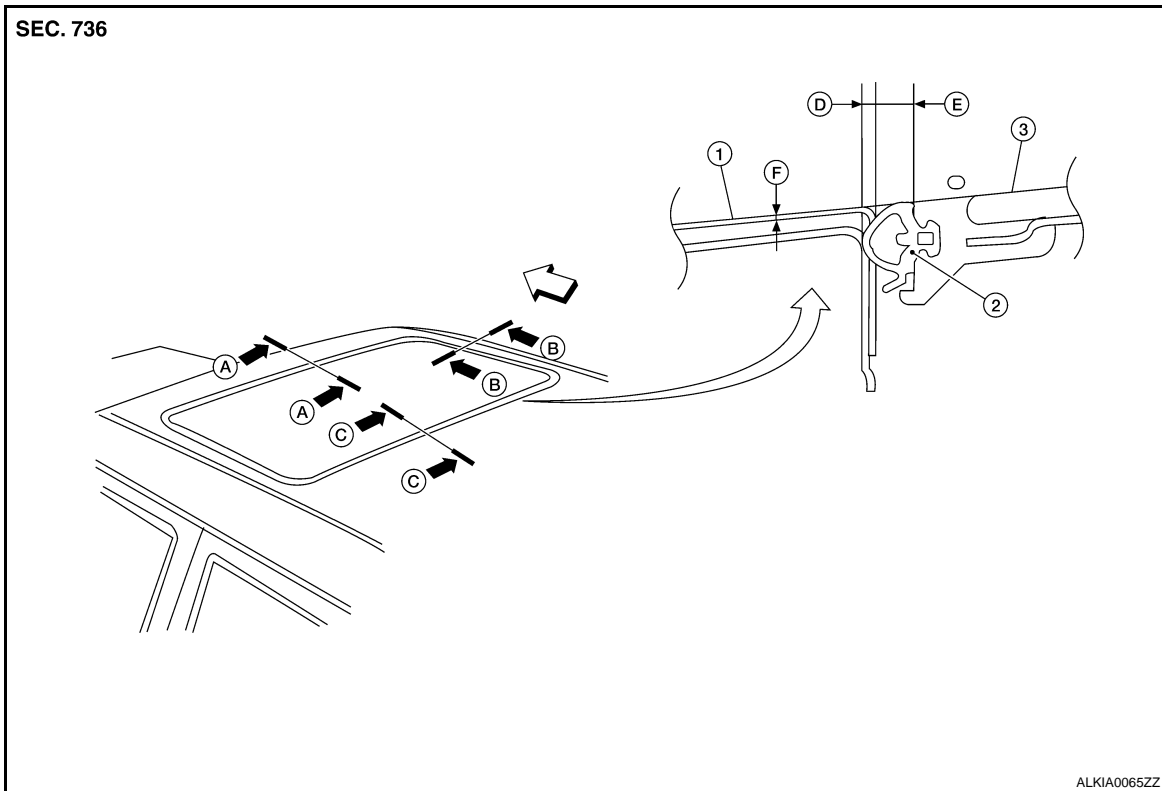

- | | | |
|-----------------------------------|---------------------------------|--|
| 1. Roof | 2. Weatherstrip | 3. Glass lid assembly |
| A. Front edge specifications | B. Side edge specifications | C. Rear edge specifications |
| D. Weatherstrip overlap tolerance | E. Weatherstrip width dimension | F. Surface flushness tolerance (Glass lid below roof line) |

← Vehicle front

Unit: mm (in)

	A-A	B-B	C-C
D.	1.4 ± 0.45 (0.06 ± 0.02)	1.4 ± 0.45 (0.06 ± 0.02)	1.4 ± 0.45 (0.06 ± 0.02)
E.	5.8 ± (0.23)	5.8 ± (0.23)	5.8 ± (0.23)
F.	-0.8 ± 1.5 (-0.03 ± 0.06)	-0.8 ± 1.5 (-0.03 ± 0.06)	-0.8 ± 1.5 (-0.03 ± 0.06)

Gap adjustment (A-A, C-C)

1. Open sunshade assembly.
2. Tilt glass lid assembly up, then release side trim cover and set aside.
3. Loosen glass lid assembly bolts (1) (2 each on left and right sides), then tilt glass lid assembly down.
4. Manually adjust glass lid assembly from outside of vehicle so gaps A-A and C-C are within specifications.

NOTE:

Temporarily snug glass lid assembly bolts to prevent movement between each adjustment.

5. Tilt glass lid assembly up and down several times using sunroof switch to check that it operates smoothly.

6. Tilt glass lid assembly up and tighten bolts to specification.

NOTE:

First tighten left front bolt, then right rear bolt on glass lid assembly to prevent uneven torque while tightening remaining bolts.

7. Attach side trim cover, then tilt glass lid assembly down.

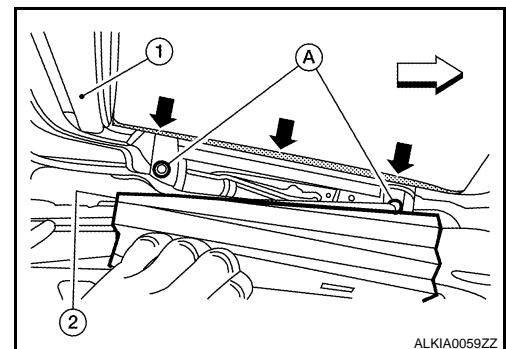

SUNROOF UNIT ASSEMBLY

< ON-VEHICLE REPAIR >

Gap Adjustment (B-B)

1. Remove headlining. Refer to [INT-18, "Removal and Installation"](#). A
2. Loosen sunroof unit assembly and sunroof side bracket bolts.
3. Carefully slide sunroof unit assembly side to side or add shims until gap is within specifications. B
NOTE:
Temporarily snug sunroof unit assembly bolts to prevent movement between each adjustment.
4. Tilt glass lid assembly up and down several times using sunroof switch to check that it operates smoothly. C
5. Tighten sunroof unit assembly and sunroof side bracket bolts. D
NOTE:
First tighten left front sunroof unit assembly bolt, then right rear to prevent uneven torque while tightening remaining bolts.
6. Install headlining. Refer to [INT-18, "Removal and Installation"](#).

Height Adjustment

1. Tilt glass lid assembly up and down several times using sunroof switch to check that it operates smoothly. E
2. Check height difference between roof surface and glass lid assembly surface, then compare to specifications. F
3. If necessary, adjust height difference by using the following procedure. G
 - Loosen glass lid assembly bolts.
 - Manually raise/lower glass lid assembly until height difference is within specification.**NOTE:**
If necessary, shims may be added between sunroof unit assembly and roof to increase adjustment range. Refer to [RF-60, "Inspection"](#). H
Temporarily snug sunroof unit assembly bolts to prevent movement between each adjustment.
- Tilt glass lid assembly up and down several times using sunroof switch to check that it operates smoothly. I
- Tighten glass lid assembly and sunroof side bracket bolts. J
NOTE:
First tighten left front bolt, then right rear bolt on glass lid assembly to prevent uneven torque while tightening remaining bolts.
- After any adjustment, check sunroof operation and glass lid assembly alignment.

RF

L

M

N

O

P

SUNROOF UNIT ASSEMBLY

< ON-VEHICLE REPAIR >

Exploded View

INFOID:000000003071509

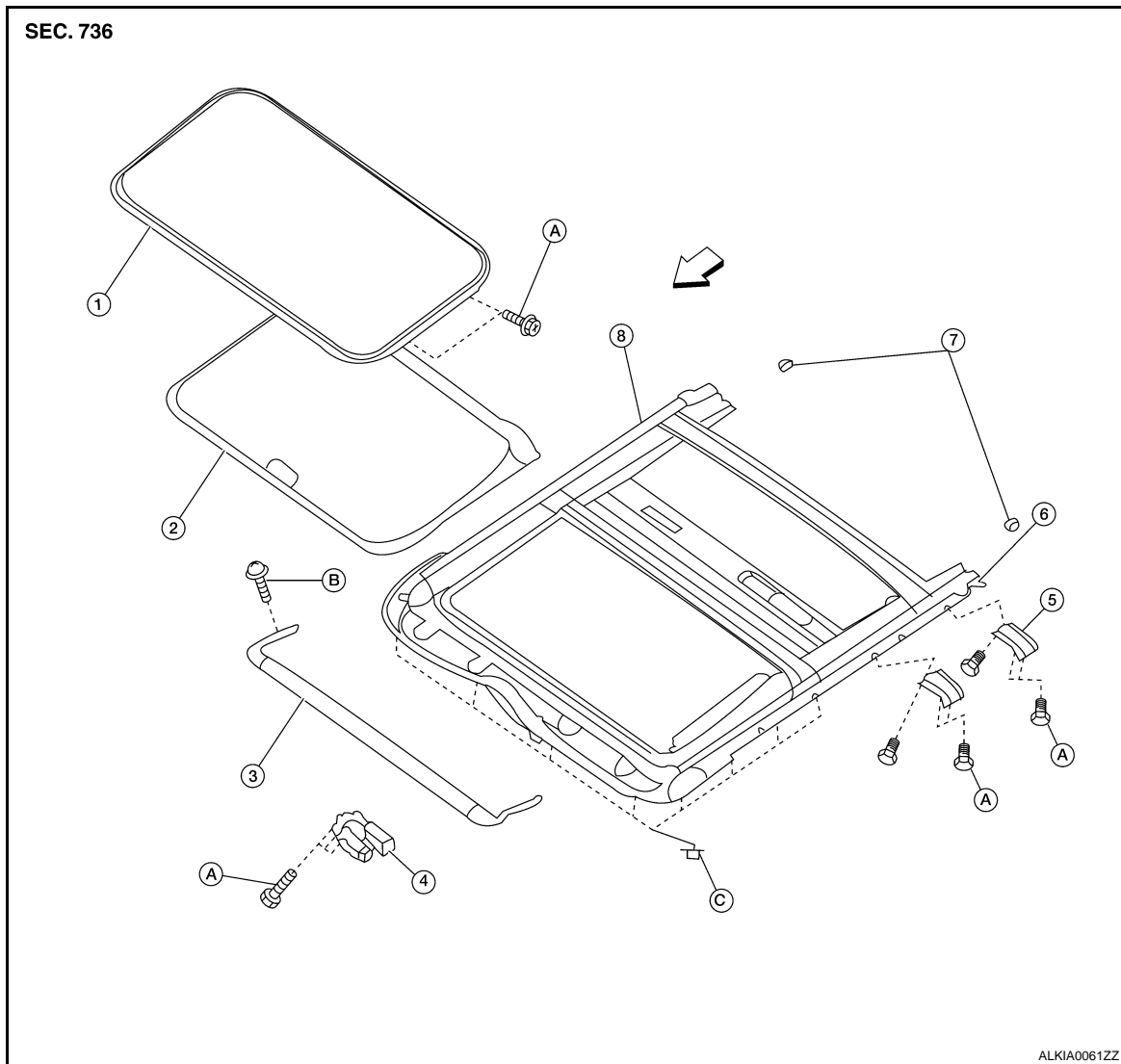

- | | | |
|---------------------------|--------------------------|-------------------------|
| 1. Glass lid assembly | 2. Sunshade | 3. Wind deflector |
| 4. Sunroof motor assembly | 5. Sunroof side bracket | 6. Drain hose connector |
| 7. Sunshade stopper | 8. Sunroof unit assembly | A. Bolt |
| B. Screw | C. Nut | ← Vehicle front |

Removal and Installation

INFOID:000000003071510

CAUTION:

- After installing either sunroof unit assembly or glass lid assembly, check gap/height adjustments and operation to make sure there is no malfunction.
- Always work with a helper.
- Handle glass lid assembly with care to prevent damage.
- When taking sunroof unit out, use shop cloths to protect the seats and trim from damage.

SUNROOF UNIT ASSEMBLY

Removal

1. Close glass lid assembly.
2. Remove headlining. Refer to [INT-18, "Removal and Installation"](#).
3. Disconnect drain hoses.

SUNROOF UNIT ASSEMBLY

< ON-VEHICLE REPAIR >

4. Remove screws (A), then pull sunroof switch bracket (1) away from sunroof unit assembly.
↳ Vehicle front
5. Disconnect sunroof motor harness connector.

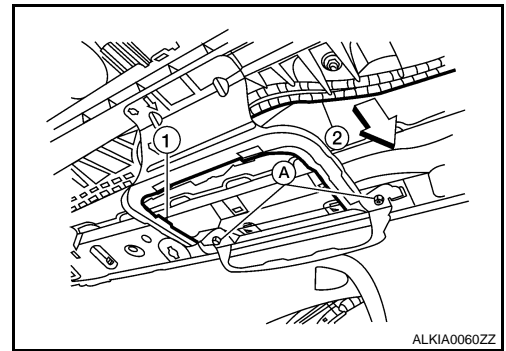

6. Remove bolts on the front end and side rails of the sunroof unit assembly.
7. Remove front sunroof side bracket bolts.
8. Remove rear sunroof side bracket bolts and remove sunroof unit assembly from roof panel.
9. Remove sunroof unit assembly through the passenger compartment while being careful not to damage the seats and trim.

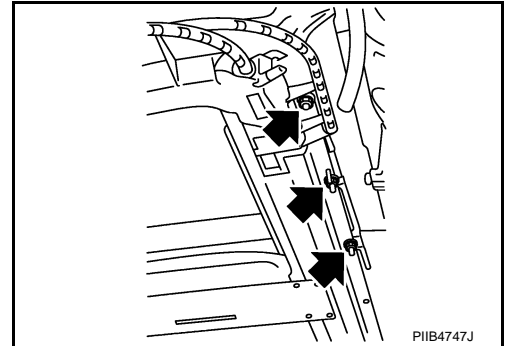

Installation

1. Loosely tighten the rear sunroof side bracket bolts to the sunroof unit assembly side rails.
2. Bring sunroof unit into passenger compartment and loosely tighten rear sunroof side bracket bolts to roof panel while supporting front.
3. Align the sunroof unit assembly front end rail and side rails with the locator pins, then loosely tighten the bolts.
4. Install remaining sunroof side brackets and loosely tighten bolts.
5. Tighten the sunroof unit assembly front end and side rail bolts diagonally to the specified torque.
6. Tighten the front sunroof side bracket bolts at the vehicle side first, then at the side rail end.
7. Tighten the rear sunroof side bracket bolts at the vehicle side first, then at the side rail end.
8. Connect sunroof motor harness connector.
9. Install sunroof switch bracket.
10. Connect drain hoses.
11. Install headlining. Refer to [INT-18. "Removal and Installation"](#).

GLASS LID ASSEMBLY

Removal

1. Open sunshade, then close glass lid assembly.
2. Slide the side trim covers (2) RH/LH inward, then release them from the glass lid assembly inside edge and set aside.
↳ Vehicle front
3. Remove the bolts (A) and glass lid assembly from sunroof unit assembly.

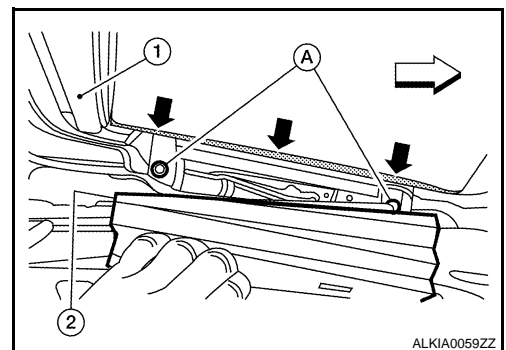

Installation

1. Position glass lid assembly to sunroof unit assembly.
2. Tighten glass lid assembly bolts to specification.

SUNROOF UNIT ASSEMBLY

< ON-VEHICLE REPAIR >

NOTE:

First tighten left front bolt, then right rear bolt on glass lid assembly to prevent uneven torque while tightening remaining bolts.

3. Slide side trim covers onto inside edge of glass lid assembly.
4. After installation, check sunroof operation and glass lid assembly alignment. Refer to [RF-60, "Inspection"](#).

SUNSHADE

Removal

1. Remove sunroof unit assembly. Refer to [RF-64, "Exploded View"](#).
2. Remove glass lid assembly. Refer to [RF-64, "Removal and Installation"](#).
3. Remove the sunshade stoppers (1) RH/LH from the sunroof unit assembly side rails (2).
← Vehicle front
4. Slide sunshade rearward past sunroof unit assembly side rail ends to remove.

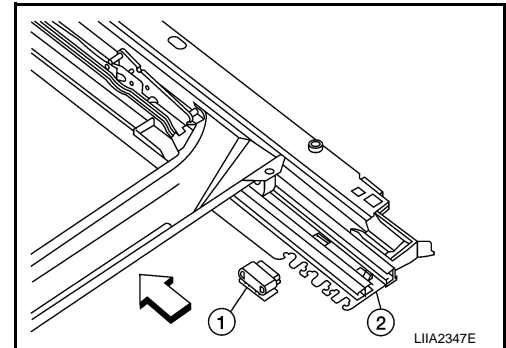

Installation

Installation is in the reverse order of removal.

SUNROOF MOTOR

Removal

1. Close glass lid assembly.
2. Disconnect the negative and positive battery cables.
3. Remove map lamp assembly from headliner (4). Refer to [INT-18, "Exploded View"](#).
← Vehicle front
4. Remove sunroof motor screws (A).
5. Disconnect harness connector (2) and remove sunroof motor (1) from sunroof unit assembly front end rail.

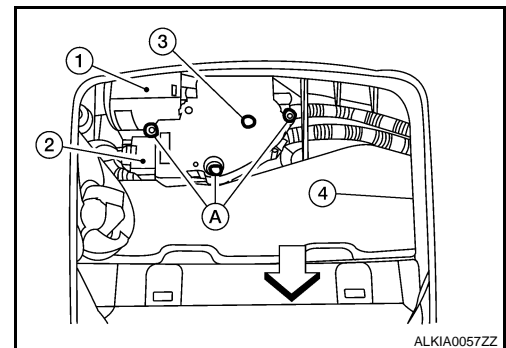

CAUTION:

Never run the removed sunroof motor as a single unit.

Installation

1. Move sunroof motor laterally little by little so that the gear is completely engaged into the wire on the sunroof unit assembly, and the mounting surfaces become parallel. Install the sunroof motor screws, and tighten to the specified torque.

CAUTION:

Before installing the motor, be sure to place the link and wire assembly in the symmetrical and fully closed position.

NOTE:

If necessary, insert a suitable tool into the drive key (3) and rotate right or left slightly to assist in complete sunroof motor gear alignment.

Remainder of installation is in the reverse order of removal.

2. Connect battery positive and negative terminals.
3. Synchronize sunroof motor with sunroof unit assembly. Refer to [RF-6, "ADDITIONAL SERVICE WHEN REPLACING CONTROL UNIT : Special Repair Requirement"](#).