

SECTION **AV**

AUDIO, VISUAL & NAVIGATION SYSTEM

CONTENTS

<b>BASE AUDIO</b>		
<b>BASIC INSPECTION</b> .....	9	
<b>DIAGNOSIS AND REPAIR WORKFLOW</b> .....	9	
Work Flow .....	9	
<b>FUNCTION DIAGNOSIS</b> .....	11	
<b>AUDIO SYSTEM (COUPE)</b> .....	11	
System Diagram .....	11	
System Description .....	11	
Component Parts Location .....	12	
Component Description .....	12	
<b>AUDIO SYSTEM (SEDAN)</b> .....	14	
System Diagram .....	14	
System Description .....	14	
Component Parts Location .....	15	
Component Description .....	15	
<b>DIAGNOSIS SYSTEM (AUDIO UNIT)</b> .....	17	
Diagnosis Description .....	17	
<b>COMPONENT DIAGNOSIS</b> .....	20	
<b>POWER SUPPLY AND GROUND CIRCUIT (COUPE)</b> .....	20	
<b>AUDIO UNIT</b> .....	20	
AUDIO UNIT : Diagnosis Procedure .....	20	
<b>SATELLITE RADIO TUNER</b> .....	20	
SATELLITE RADIO TUNER : Diagnosis Procedure .....	20	
<b>POWER SUPPLY AND GROUND CIRCUIT (SEDAN)</b> .....	22	
<b>AUDIO UNIT</b> .....	22	
AUDIO UNIT : Diagnosis Procedure .....	22	
<b>SATELLITE RADIO TUNER</b> .....	22	
SATELLITE RADIO TUNER : Diagnosis Procedure .....	22	
<b>DOOR SPEAKER (COUPE)</b> .....	24	
Description .....	24	
Diagnosis Procedure .....	24	
<b>FRONT DOOR SPEAKER (SEDAN)</b> .....	26	
Description .....	26	
Diagnosis Procedure .....	26	
<b>FRONT TWEETER (COUPE)</b> .....	28	
Description .....	28	
Diagnosis Procedure .....	28	
<b>TWEETER (SEDAN)</b> .....	30	
Description .....	30	
Diagnosis Procedure .....	30	
<b>REAR SPEAKER</b> .....	32	
Description .....	32	
Diagnosis Procedure .....	32	
<b>STEERING SWITCH</b> .....	34	
Description .....	34	
Diagnosis Procedure .....	34	
<b>COMMUNICATION SIGNAL CIRCUIT (COUPE)</b> .....	36	
<b>SATELLITE RADIO TUNER</b> .....	36	
SATELLITE RADIO TUNER : Description .....	36	
SATELLITE RADIO TUNER : Diagnosis Procedure .....	36	
<b>COMMUNICATION SIGNAL CIRCUIT (SEDAN)</b> .....	38	
<b>SATELLITE RADIO TUNER</b> .....	38	
SATELLITE RADIO TUNER : Description .....	38	
SATELLITE RADIO TUNER : Diagnosis Procedure .....	38	

A  
B  
C  
D  
E  
F  
G  
H  
I  
J  
K  
L  
M  
AV  
O  
P

<b>SOUND SIGNAL CIRCUIT (COUPE)</b> .....	40	<b>REAR SPEAKER</b> .....	73
<b>SATELLITE RADIO TUNER</b> .....	40	Removal and Installation - Coupe .....	73
SATELLITE RADIO TUNER : Description .....	40	Removal and Installation - Sedan .....	73
SATELLITE RADIO TUNER : Diagnosis Procedure .....	40	<b>STEERING SWITCH</b> .....	74
<b>SOUND SIGNAL CIRCUIT (SEDAN)</b> .....	42	Removal and Installation .....	74
<b>SATELLITE RADIO TUNER</b> .....	42	<b>ANTENNA AMP.</b> .....	75
SATELLITE RADIO TUNER : Description .....	42	Removal and Installation - Coupe .....	75
SATELLITE RADIO TUNER : Diagnosis Procedure .....	42	Removal and Installation - Sedan .....	75
<b>ECU DIAGNOSIS</b> .....	44	<b>AUDIO ANTENNA (COUPE)</b> .....	76
<b>AUDIO UNIT (COUPE)</b> .....	44	Location of Antenna .....	76
Reference Value .....	44	Window Antenna Repair .....	76
Wiring Diagram — Coupe .....	47	<b>AUDIO ANTENNA (SEDAN)</b> .....	79
<b>AUDIO UNIT (SEDAN)</b> .....	54	Location of Antenna .....	79
Reference Value .....	54	Window Antenna Repair .....	79
Wiring Diagram — Sedan .....	57	<b>BOSE AUDIO WITHOUT NAVIGATION</b>	
<b>SATELLITE RADIO TUNER</b> .....	64	<b>BASIC INSPECTION</b> .....	82
Reference Value .....	64	<b>DIAGNOSIS AND REPAIR WORKFLOW</b> .....	82
<b>SYMPTOM DIAGNOSIS</b> .....	66	Work Flow .....	82
<b>AUDIO SYSTEM</b> .....	66	<b>FUNCTION DIAGNOSIS</b> .....	84
<b>AUDIO UNIT</b> .....	66	<b>AUDIO SYSTEM (COUPE)</b> .....	84
AUDIO UNIT : Symptom Table .....	66	System Diagram .....	84
<b>CD</b> .....	66	System Description .....	84
CD : Symptom Table .....	66	Component Parts Location .....	85
<b>SATELLITE RADIO TUNER</b> .....	66	Component Description .....	86
SATELLITE RADIO TUNER : Symptom Table .....	66	<b>AUDIO SYSTEM (SEDAN)</b> .....	87
<b>NORMAL OPERATING CONDITION</b> .....	67	System Diagram .....	87
Description .....	67	System Description .....	87
<b>PRECAUTION</b> .....	68	Component Parts Location .....	88
<b>PRECAUTIONS</b> .....	68	Component Description .....	89
Supplemental Restraint System (SRS) "AIR BAG" and "SEAT BELT PRE-TENSIONER" .....	68	<b>HANDS FREE PHONE SYSTEM (COUPE)</b> .....	90
<b>PREPARATION</b> .....	69	System Diagram .....	90
<b>PREPARATION</b> .....	69	System Description .....	90
Commercial Service Tools .....	69	Component Parts Location .....	91
<b>ON-VEHICLE REPAIR</b> .....	70	Component Description .....	92
<b>AUDIO UNIT</b> .....	70	<b>HANDS FREE PHONE SYSTEM (SEDAN)</b> .....	93
Removal and Installation .....	70	System Diagram .....	93
<b>FRONT TWEETER</b> .....	71	System Description .....	93
Removal and Installation .....	71	Component Parts Location .....	94
<b>FRONT DOOR SPEAKER</b> .....	72	Component Description .....	95
Removal and Installation .....	72	<b>DIAGNOSIS SYSTEM (AUDIO UNIT)</b> .....	96
		Diagnosis Description .....	96
		<b>DIAGNOSIS SYSTEM (BLUETOOTH CONTROL UNIT)</b> .....	99
		Diagnosis Description .....	99
		Work Flow .....	99
		<b>COMPONENT DIAGNOSIS</b> .....	100

<b>POWER SUPPLY AND GROUND CIRCUIT (COUPE)</b> .....	<b>100</b>	<b>REAR DOOR SPEAKER (SEDAN)</b> .....	<b>127</b>	
		Description .....	127	A
		Diagnosis Procedure .....	127	
<b>AUDIO UNIT</b> .....	<b>100</b>	<b>SUBWOOFER</b> .....	<b>130</b>	B
AUDIO UNIT : Diagnosis Procedure .....	100	Description .....	130	
<b>BOSE SPEAKER AMP</b> .....	<b>100</b>	Diagnosis Procedure .....	130	
BOSE SPEAKER AMP : Diagnosis Procedure .....	100	<b>AMP ON SIGNAL CIRCUIT</b> .....	<b>133</b>	C
<b>SATELLITE RADIO TUNER</b> .....	<b>101</b>	Description .....	133	
SATELLITE RADIO TUNER : Diagnosis Procedure .....	101	Diagnosis Procedure .....	133	
<b>BLUETOOTH CONTROL UNIT</b> .....	<b>102</b>	<b>STEERING SWITCH (COUPE)</b> .....	<b>134</b>	D
BLUETOOTH CONTROL UNIT : Diagnosis Procedure .....	102	Description .....	134	
<b>MICROPHONE</b> .....	<b>103</b>	Diagnosis Procedure .....	134	E
MICROPHONE : Diagnosis Procedure .....	103	Component Inspection .....	136	
<b>POWER SUPPLY AND GROUND CIRCUIT (SEDAN)</b> .....	<b>105</b>	<b>STEERING SWITCH (SEDAN)</b> .....	<b>137</b>	F
		Description .....	137	
<b>AUDIO UNIT</b> .....	<b>105</b>	Diagnosis Procedure .....	137	
AUDIO UNIT : Diagnosis Procedure .....	105	Component Inspection .....	139	
<b>BOSE SPEAKER AMP</b> .....	<b>105</b>	<b>COMMUNICATION SIGNAL CIRCUIT (COUPE)</b> .....	<b>140</b>	G
BOSE SPEAKER AMP : Diagnosis Procedure .....	105	<b>SATELLITE RADIO TUNER</b> .....	<b>140</b>	H
<b>SATELLITE RADIO TUNER</b> .....	<b>106</b>	SATELLITE RADIO TUNER : Description .....	140	
SATELLITE RADIO TUNER : Diagnosis Procedure .....	106	SATELLITE RADIO TUNER : Diagnosis Procedure .....	140	I
<b>BLUETOOTH CONTROL UNIT</b> .....	<b>107</b>	<b>COMMUNICATION SIGNAL CIRCUIT (SEDAN)</b> .....	<b>142</b>	J
BLUETOOTH CONTROL UNIT : Diagnosis Procedure .....	107	<b>SATELLITE RADIO TUNER</b> .....	<b>142</b>	
<b>MICROPHONE</b> .....	<b>108</b>	SATELLITE RADIO TUNER : Description .....	142	
MICROPHONE : Diagnosis Procedure .....	108	SATELLITE RADIO TUNER : Diagnosis Procedure .....	142	K
<b>DOOR SPEAKER (COUPE)</b> .....	<b>110</b>	<b>SOUND SIGNAL CIRCUIT (COUPE)</b> .....	<b>144</b>	L
Description .....	110	<b>SATELLITE RADIO TUNER</b> .....	<b>144</b>	
Diagnosis Procedure .....	110	SATELLITE RADIO TUNER : Description .....	144	
<b>FRONT DOOR SPEAKER (SEDAN)</b> .....	<b>113</b>	SATELLITE RADIO TUNER : Diagnosis Procedure .....	144	M
Description .....	113	<b>SOUND SIGNAL CIRCUIT (SEDAN)</b> .....	<b>146</b>	
Diagnosis Procedure .....	113	<b>SATELLITE RADIO TUNER</b> .....	<b>146</b>	AV
<b>FRONT TWEETER (COUPE)</b> .....	<b>116</b>	SATELLITE RADIO TUNER : Description .....	146	
Description .....	116	SATELLITE RADIO TUNER : Diagnosis Procedure .....	146	O
Diagnosis Procedure .....	116	<b>MICROPHONE SIGNAL CIRCUIT (COUPE)</b> ..	<b>148</b>	
<b>TWEETER (SEDAN)</b> .....	<b>119</b>	Description .....	148	
Description .....	119	Diagnosis Procedure .....	148	P
Diagnosis Procedure .....	119	<b>MICROPHONE SIGNAL CIRCUIT (SEDAN)</b> ..	<b>150</b>	
<b>CENTER SPEAKER</b> .....	<b>122</b>	Description .....	150	
Description .....	122	Diagnosis Procedure .....	150	
Diagnosis Procedure .....	122	<b>ECU DIAGNOSIS</b> .....	<b>152</b>	
<b>REAR TWEETER (COUPE)</b> .....	<b>124</b>	<b>AUDIO UNIT (COUPE)</b> .....	<b>152</b>	
Description .....	124			
Diagnosis Procedure .....	124			

Reference Value .....	152	<b>REAR SPEAKER</b> .....	<b>212</b>
Wiring Diagram - Coupe .....	157	Removal and Installation - Coupe .....	212
<b>AUDIO UNIT (SEDAN)</b> .....	<b>171</b>	Removal and Installation - Sedan .....	212
Reference Value .....	171	<b>WOOFER</b> .....	<b>213</b>
Wiring Diagram - Sedan .....	176	Components .....	213
<b>BOSE SPEAKER AMP</b> .....	<b>191</b>	Removal and Installation .....	213
Reference Value .....	191	<b>SATELLITE RADIO TUNER</b> .....	<b>214</b>
<b>SATELLITE RADIO TUNER</b> .....	<b>194</b>	Removal and Installation - Coupe .....	214
Reference Value .....	194	Removal and Installation - Sedan .....	214
<b>BLUETOOTH CONTROL UNIT</b> .....	<b>196</b>	<b>SATELLITE RADIO ANTENNA</b> .....	<b>215</b>
Reference Value .....	196	Removal and Installation .....	215
<b>SYMPTOM DIAGNOSIS</b> .....	<b>199</b>	<b>STEERING SWITCH</b> .....	<b>216</b>
<b>AUDIO SYSTEM (COUPE)</b> .....	<b>199</b>	Removal and Installation .....	216
Symptom Table .....	199	<b>AUDIO ANTENNA (COUPE)</b> .....	<b>217</b>
<b>AUDIO SYSTEM (SEDAN)</b> .....	<b>200</b>	Location of Antenna .....	217
Symptom Table .....	200	Window Antenna Repair .....	217
<b>NORMAL OPERATING CONDITION</b> .....	<b>201</b>	<b>AUDIO ANTENNA (SEDAN)</b> .....	<b>220</b>
Description .....	201	Location of Antenna .....	220
<b>PRECAUTION</b> .....	<b>202</b>	Window Antenna Repair .....	220
<b>PRECAUTIONS</b> .....	<b>202</b>	<b>ANTENNA AMP.</b> .....	<b>223</b>
Supplemental Restraint System (SRS) "AIR BAG" and "SEAT BELT PRE-TENSIONER" .....	202	Removal and Installation - Coupe .....	223
<b>PREPARATION</b> .....	<b>203</b>	Removal and Installation - Sedan .....	223
<b>PREPARATION</b> .....	<b>203</b>	<b>MICROPHONE</b> .....	<b>224</b>
Commercial Service Tools .....	203	Removal and Installation - Coupe .....	224
<b>ON-VEHICLE REPAIR</b> .....	<b>204</b>	Removal and Installation - Sedan .....	224
<b>AUDIO UNIT</b> .....	<b>204</b>	<b>TEL ANTENNA</b> .....	<b>226</b>
Removal and Installation .....	204	Removal and Installation - Coupe .....	226
<b>BOSE SPEAKER AMP</b> .....	<b>205</b>	Removal and Installation - Sedan .....	226
Removal and Installation - Coupe .....	205	<b>BLUETOOTH CONTROL UNIT</b> .....	<b>227</b>
Removal and Installation - Sedan .....	205	Removal and Installation - Coupe .....	227
<b>CD CHANGER</b> .....	<b>206</b>	Removal and Installation - Sedan .....	227
Removal and Installation .....	206	<b>BOSE AUDIO WITH NAVIGATION</b>	
<b>FRONT TWEETER</b> .....	<b>207</b>	<b>BASIC INSPECTION</b> .....	<b>228</b>
Removal and Installation .....	207	<b>DIAGNOSIS AND REPAIR WORKFLOW</b> .....	<b>228</b>
<b>CENTER SPEAKER</b> .....	<b>208</b>	Work Flow .....	228
Removal and Installation .....	208	<b>INSPECTION AND ADJUSTMENT</b> .....	<b>230</b>
<b>FRONT DOOR SPEAKER</b> .....	<b>209</b>	<b>REAR VIEW MONITOR GUIDING LINE ADJUST- MENT</b> .....	<b>230</b>
Removal and Installation .....	209	REAR VIEW MONITOR GUIDING LINE ADJUST- MENT : Description .....	230
<b>REAR DOOR SPEAKER</b> .....	<b>210</b>	REAR VIEW MONITOR GUIDING LINE ADJUST- MENT : Special Repair Requirement .....	230
Removal and Installation - Sedan .....	210	<b>FUNCTION DIAGNOSIS</b> .....	<b>232</b>
<b>REAR TWEETER</b> .....	<b>211</b>	<b>MULTI AV SYSTEM (COUPE)</b> .....	<b>232</b>
Removal and Installation - Coupe .....	211	System Diagram .....	232
		System Description .....	232



Component Parts Location .....	234	<b>COMPONENT DIAGNOSIS .....</b>	<b>283</b>	
Component Description .....	235	<b>U1000 CAN COMM CIRCUIT .....</b>	<b>283</b>	A
<b>MULTI AV SYSTEM (SEDAN) .....</b>	<b>236</b>	Description .....	283	
System Diagram .....	236	DTC Logic .....	283	B
System Description .....	236	Diagnosis Procedure .....	283	
Component Parts Location .....	238	<b>U1010 CONTROL UNIT (CAN) .....</b>	<b>284</b>	C
Component Description .....	240	Description .....	284	
<b>NAVIGATION SYSTEM (COUPE) .....</b>	<b>242</b>	DTC Logic .....	284	
System Diagram .....	242	Diagnosis Procedure .....	284	D
System Description .....	242	<b>U1200 AV CONTROL UNIT .....</b>	<b>285</b>	
Component Parts Location .....	245	Description .....	285	E
Component Description .....	246	DTC Logic .....	285	
<b>NAVIGATION SYSTEM (SEDAN) .....</b>	<b>247</b>	<b>U1201 AV CONTROL UNIT .....</b>	<b>286</b>	F
System Diagram .....	247	Description .....	286	
System Description .....	247	DTC Logic .....	286	
Component Parts Location .....	250	<b>U1204 GPS COMM .....</b>	<b>287</b>	G
Component Description .....	252	Description .....	287	
<b>REAR VIEW MONITOR SYSTEM (COUPE) ...</b>	<b>253</b>	DTC Logic .....	287	
System Diagram .....	253	<b>U1205 GPS ROM .....</b>	<b>288</b>	H
System Description .....	253	Description .....	288	
Component Parts Location .....	254	DTC Logic .....	288	
Component Description .....	255	<b>U1206 GPS RAM .....</b>	<b>289</b>	I
<b>REAR VIEW MONITOR SYSTEM (SEDAN) ...</b>	<b>256</b>	Description .....	289	
System Diagram .....	256	DTC Logic .....	289	
System Description .....	256	<b>U1207 GPS RTC .....</b>	<b>290</b>	J
Component Parts Location .....	257	Description .....	290	
Component Description .....	259	DTC Logic .....	290	
<b>AUDIO SYSTEM (COUPE) .....</b>	<b>260</b>	<b>U1208 DVD-ROM COMM .....</b>	<b>291</b>	K
System Diagram .....	260	Description .....	291	
System Description .....	260	DTC Logic .....	291	
Component Parts Location .....	261	Diagnosis Procedure .....	291	L
Component Description .....	262	<b>U1209 DVD-ROM READ .....</b>	<b>292</b>	
<b>AUDIO SYSTEM (SEDAN) .....</b>	<b>263</b>	Description .....	292	M
System Diagram .....	263	DTC Logic .....	292	
System Description .....	263	Diagnosis Procedure .....	292	
Component Parts Location .....	264	<b>U120A DVD-ROM DISC .....</b>	<b>293</b>	AV
Component Description .....	266	Description .....	293	
<b>HANDS FREE PHONE SYSTEM (COUPE) ....</b>	<b>267</b>	DTC Logic .....	293	
System Diagram .....	267	Diagnosis Procedure .....	293	O
System Description .....	267	<b>U120C DVD-ROM MECHA DETECT .....</b>	<b>294</b>	
Component Parts Location .....	268	Description .....	294	
Component Description .....	269	DTC Logic .....	294	P
<b>HANDS FREE PHONE SYSTEM (SEDAN) ....</b>	<b>270</b>	Diagnosis Procedure .....	294	
System Diagram .....	270	<b>U120D DVD-ROM DRIVE MECHA .....</b>	<b>295</b>	
System Description .....	270	Description .....	295	
Component Parts Location .....	271	DTC Logic .....	295	
Component Description .....	273	Diagnosis Procedure .....	295	
<b>DIAGNOSIS SYSTEM (AV CONTROL UNIT)..</b>	<b>274</b>	<b>U1210 DVD-ROM SEEK .....</b>		
Diagnosis Description .....	274			
CONSULT - III Function (MULTI AV) .....	281			

Description .....	296	CD CHANGER : Diagnosis Procedure .....	310
DTC Logic .....	296	<b>MICROPHONE .....</b>	<b>311</b>
Diagnosis Procedure .....	296	MICROPHONE : Diagnosis Procedure .....	311
<b>U1212 DVD-ROM DATA FORWARD .....</b>	<b>297</b>	<b>POWER SUPPLY AND GROUND CIRCUIT (SEDAN) .....</b>	<b>313</b>
Description .....	297	<b>AV CONTROL UNIT .....</b>	<b>313</b>
DTC Logic .....	297	AV CONTROL UNIT : Diagnosis Procedure .....	313
Diagnosis Procedure .....	297	<b>REAR VIEW CAMERA CONTROL UNIT .....</b>	<b>313</b>
<b>U1213 DVD-ROM DATA .....</b>	<b>298</b>	REAR VIEW CAMERA CONTROL UNIT : Diagnosis Procedure .....	313
Description .....	298	<b>REAR VIEW CAMERA .....</b>	<b>314</b>
DTC Logic .....	298	REAR VIEW CAMERA : Diagnosis Procedure .....	314
Diagnosis Procedure .....	298	<b>BOSE SPEAKER AMP .....</b>	<b>315</b>
<b>U1214 DVD-ROM TIMEOUT .....</b>	<b>299</b>	BOSE SPEAKER AMP : Diagnosis Procedure .....	315
Description .....	299	<b>CD CHANGER .....</b>	<b>316</b>
DTC Logic .....	299	CD CHANGER : Diagnosis Procedure .....	316
Diagnosis Procedure .....	299	<b>MICROPHONE .....</b>	<b>317</b>
<b>U1215 DVD-ROM LOAD .....</b>	<b>300</b>	MICROPHONE : Diagnosis Procedure .....	317
Description .....	300	<b>DOOR SPEAKER (COUPE) .....</b>	<b>319</b>
DTC Logic .....	300	Description .....	319
Diagnosis Procedure .....	300	Diagnosis Procedure .....	319
<b>U1216 AV CONTROL UNIT .....</b>	<b>301</b>	<b>FRONT DOOR SPEAKER (SEDAN) .....</b>	<b>322</b>
Description .....	301	Description .....	322
DTC Logic .....	301	Diagnosis Procedure .....	322
<b>U1217 AV CONTROL UNIT .....</b>	<b>302</b>	<b>FRONT TWEETER (COUPE) .....</b>	<b>325</b>
Description .....	302	Description .....	325
DTC Logic .....	302	Diagnosis Procedure .....	325
<b>U1220 AV CONTROL UNIT .....</b>	<b>303</b>	<b>TWEETER (SEDAN) .....</b>	<b>328</b>
Description .....	303	Description .....	328
DTC Logic .....	303	Diagnosis Procedure .....	328
<b>U1244 GPS ANTENNA .....</b>	<b>304</b>	<b>CENTER SPEAKER .....</b>	<b>331</b>
Description .....	304	Description .....	331
DTC Logic .....	304	Diagnosis Procedure .....	331
Diagnosis Procedure .....	304	<b>REAR TWEETER (COUPE) .....</b>	<b>333</b>
<b>U124C CD CHANGER .....</b>	<b>305</b>	Description .....	333
Description .....	305	Diagnosis Procedure .....	333
DTC Logic .....	305	<b>REAR DOOR SPEAKER (SEDAN) .....</b>	<b>336</b>
Diagnosis Procedure .....	305	Description .....	336
<b>POWER SUPPLY AND GROUND CIRCUIT (COUPE) .....</b>	<b>307</b>	Diagnosis Procedure .....	336
<b>AV CONTROL UNIT .....</b>	<b>307</b>	<b>SUBWOOFER .....</b>	<b>339</b>
AV CONTROL UNIT : Diagnosis Procedure .....	307	Description .....	339
<b>REAR VIEW CAMERA CONTROL UNIT .....</b>	<b>307</b>	Diagnosis Procedure .....	339
REAR VIEW CAMERA CONTROL UNIT : Diagnosis Procedure .....	307	<b>AMP ON SIGNAL CIRCUIT .....</b>	<b>342</b>
<b>REAR VIEW CAMERA .....</b>	<b>308</b>	Description .....	342
REAR VIEW CAMERA : Diagnosis Procedure .....	308	Diagnosis Procedure .....	342
<b>BOSE SPEAKER AMP .....</b>	<b>309</b>	<b>STEERING SWITCH .....</b>	<b>343</b>
BOSE SPEAKER AMP : Diagnosis Procedure .....	309		
<b>CD CHANGER .....</b>	<b>310</b>		

Description .....	343	Symptom Table .....	411	A
Diagnosis Procedure .....	343	<b>NORMAL OPERATING CONDITION</b> .....	<b>412</b>	
Component Inspection .....	344	Description .....	412	
<b>MICROPHONE SIGNAL CIRCUIT</b> .....	<b>345</b>	<b>PRECAUTION</b> .....	<b>420</b>	B
Description .....	345	<b>PRECAUTIONS</b> .....	<b>420</b>	
Diagnosis Procedure .....	345	Supplemental Restraint System (SRS) "AIR BAG" and "SEAT BELT PRE-TENSIONER" .....	420	C
<b>CAMERA IMAGE SIGNAL CIRCUIT (REAR VIEW CAMERA TO CAMERA CONTROL UNIT)(COUPE)</b> .....	<b>347</b>	Precaution for Trouble Diagnosis .....	420	
Description .....	347	Precaution for Harness Repair .....	420	D
Diagnosis Procedure .....	347	<b>PREPARATION</b> .....	<b>421</b>	
<b>CAMERA IMAGE SIGNAL CIRCUIT (REAR VIEW CAMERA TO CAMERA CONTROL UNIT)(SEDAN)</b> .....	<b>348</b>	<b>PREPARATION</b> .....	<b>421</b>	E
Description .....	348	Commercial Service Tools .....	421	
Diagnosis Procedure .....	348	<b>ON-VEHICLE REPAIR</b> .....	<b>422</b>	F
<b>CAMERA ON SIGNAL CIRCUIT (COUPE)</b> ....	<b>349</b>	<b>AUDIO UNIT</b> .....	<b>422</b>	
Description .....	349	Removal and Installation .....	422	G
Diagnosis Procedure .....	349	<b>BOSE SPEAKER AMP</b> .....	<b>423</b>	
<b>CAMERA ON SIGNAL CIRCUIT (SEDAN)</b> ....	<b>350</b>	Removal and Installation - Coupe .....	423	H
Description .....	350	Removal and Installation - Sedan .....	423	
Diagnosis Procedure .....	350	<b>CD CHANGER</b> .....	<b>424</b>	I
<b>CAMERA IMAGE SIGNAL CIRCUIT (CAM- ERA CONTROL UNIT TO AV CONTROL UNIT)</b> .....	<b>351</b>	Removal and Installation .....	424	
Description .....	351	<b>FRONT TWEETER</b> .....	<b>425</b>	J
Diagnosis Procedure .....	351	Removal and Installation .....	425	
<b>REVERSE SIGNAL CIRCUIT</b> .....	<b>352</b>	<b>CENTER SPEAKER</b> .....	<b>426</b>	K
Description .....	352	Removal and Installation .....	426	
Diagnosis Procedure .....	352	<b>FRONT DOOR SPEAKER</b> .....	<b>427</b>	L
<b>ECU DIAGNOSIS</b> .....	<b>353</b>	Removal and Installation .....	427	
<b>AV CONTROL UNIT (COUPE)</b> .....	<b>353</b>	<b>REAR DOOR SPEAKER</b> .....	<b>428</b>	M
Reference Value .....	353	Removal and Installation - Sedan .....	428	
Wiring Diagram .....	358	<b>REAR TWEETER</b> .....	<b>429</b>	
DTC Index .....	377	Removal and Installation - Coupe .....	429	
<b>AV CONTROL UNIT (SEDAN)</b> .....	<b>379</b>	<b>REAR SPEAKER</b> .....	<b>430</b>	
Reference Value .....	379	Removal and Installation - Coupe .....	430	
Wiring Diagram .....	384	Removal and Installation - Sedan .....	430	AV
DTC Index .....	402	<b>SATELLITE RADIO TUNER</b> .....	<b>431</b>	
<b>BOSE SPEAKER AMP</b> .....	<b>404</b>	Removal and Installation - Coupe .....	431	O
Reference Value .....	404	Removal and Installation - Sedan .....	431	
<b>REAR VIEW CAMERA CONTROL UNIT</b> .....	<b>407</b>	<b>SATELLITE RADIO ANTENNA</b> .....	<b>432</b>	
Reference Value .....	407	Removal and Installation .....	432	P
<b>CD CHANGER</b> .....	<b>409</b>	<b>GPS ANTENNA</b> .....	<b>433</b>	
Reference Value .....	409	Removal and Installation .....	433	
<b>SYMPTOM DIAGNOSIS</b> .....	<b>411</b>	<b>STEERING SWITCH</b> .....	<b>434</b>	
<b>MULTI AV SYSTEM</b> .....	<b>411</b>	Removal and Installation .....	434	
		<b>AUDIO ANTENNA (COUPE)</b> .....	<b>435</b>	

Location of Antenna .....	435	<b>TEL ANTENNA .....</b>	<b>444</b>
Window Antenna Repair .....	435	Removal and Installation - Coupe .....	444
<b>AUDIO ANTENNA (SEDAN) .....</b>	<b>438</b>	Removal and Installation - Sedan .....	444
Location of Antenna .....	438	<b>BLUETOOTH CONTROL UNIT .....</b>	<b>445</b>
Window Antenna Repair .....	438	Removal and Installation - Coupe .....	445
<b>ANTENNA AMP. ....</b>	<b>441</b>	Removal and Installation - Sedan .....	445
Removal and Installation - Coupe .....	441	<b>REAR VIEW MONITOR .....</b>	<b>446</b>
Removal and Installation - Sedan .....	441	Removal and Installation .....	446
<b>MICROPHONE .....</b>	<b>442</b>	Adjustment .....	446
Removal and Installation - Coupe .....	442	<b>CAMERA CONTROL UNIT .....</b>	<b>447</b>
Removal and Installation - Sedan .....	442	Removal and Installation - Coupe .....	447
		Removal and Installation - Sedan .....	447

## BASIC INSPECTION

### DIAGNOSIS AND REPAIR WORKFLOW

#### Work Flow

INFOID:000000001830425

#### OVERALL SEQUENCE

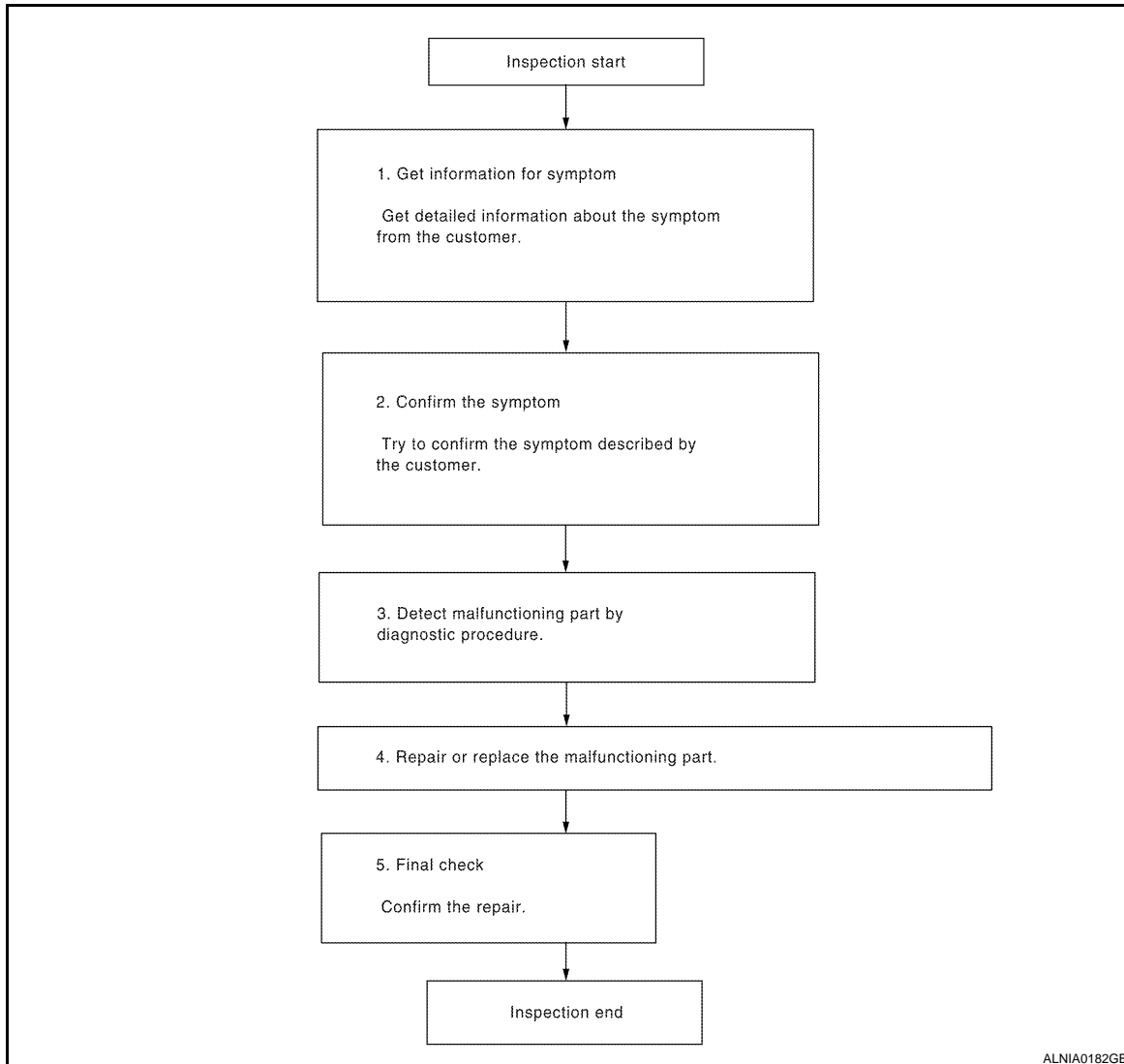

#### DETAILED FLOW

### 1.GET INFORMATION FOR SYMPTOM

Get detailed information from the customer about the symptom (the condition and the environment when the incident/malfunction occurred).

>> GO TO 2

### 2.CONFIRM THE SYMPTOM

Try to confirm the symptom described by the customer. Verify relation between the symptom and the condition when the symptom is detected.

>> GO TO 3

### 3.DETECT MALFUNCTIONING PART BY DIAGNOSTIC PROCEDURE

Inspect according to Diagnostic Procedure of the system.

A  
B  
C  
D  
E  
F  
G  
H  
I  
J  
K  
L  
M

AV

O

P

# DIAGNOSIS AND REPAIR WORKFLOW

< BASIC INSPECTION >

[BASE AUDIO]

---

Is malfunctioning part detected?

YES >> GO TO 4

NO >> GO TO 2

## 4.REPAIR OR REPLACE THE MALFUNCTIONING PART

---

1. Repair or replace the malfunctioning part.
2. Reconnect parts or connectors disconnected during Diagnostic Procedure.

>> GO TO 5

## 5.FINAL CHECK

---

Refer to confirmed symptom in step 2, and make sure that the symptom is not detected.

Has the symptom been repaired?

YES >> Inspection End.

NO >> GO TO 2

FUNCTION DIAGNOSIS

AUDIO SYSTEM (COUPE)

System Diagram

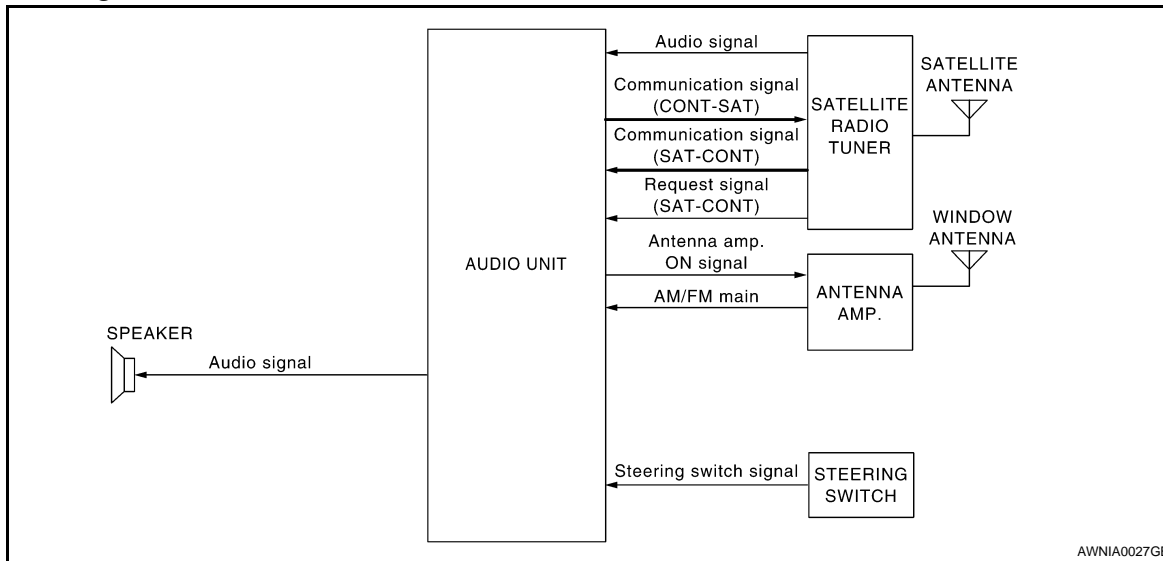

System Description

INFOID:000000001830427

AUDIO SYSTEM

The audio system consists of the following components

- Audio unit
- Window antenna
- Steering wheel audio control switches
- Door speakers
- Front tweeters
- Rear speakers

When the audio system is on, radio signals are received by the window antenna. The audio unit then sends audio signals to the door speakers, front tweeters and rear speakers.

Refer to Owner's Manual for audio system operating instructions.

SATELLITE RADIO SYSTEM

The satellite radio system consists of the following components

- Roof antenna (satellite)
- Satellite radio tuner

When the satellite radio system is on, radio signals are supplied to the satellite radio tuner from the satellite antenna. The satellite radio tuner then sends audio signals to the audio unit.

Refer to Owner's Manual for satellite radio system operating instructions.

A  
B  
C  
D  
E  
F  
G  
H  
I  
J  
K  
L  
M  
AV  
O  
P

# AUDIO SYSTEM (COUPE)

< FUNCTION DIAGNOSIS >

[BASE AUDIO]

## Component Parts Location

INFOID:000000001830428

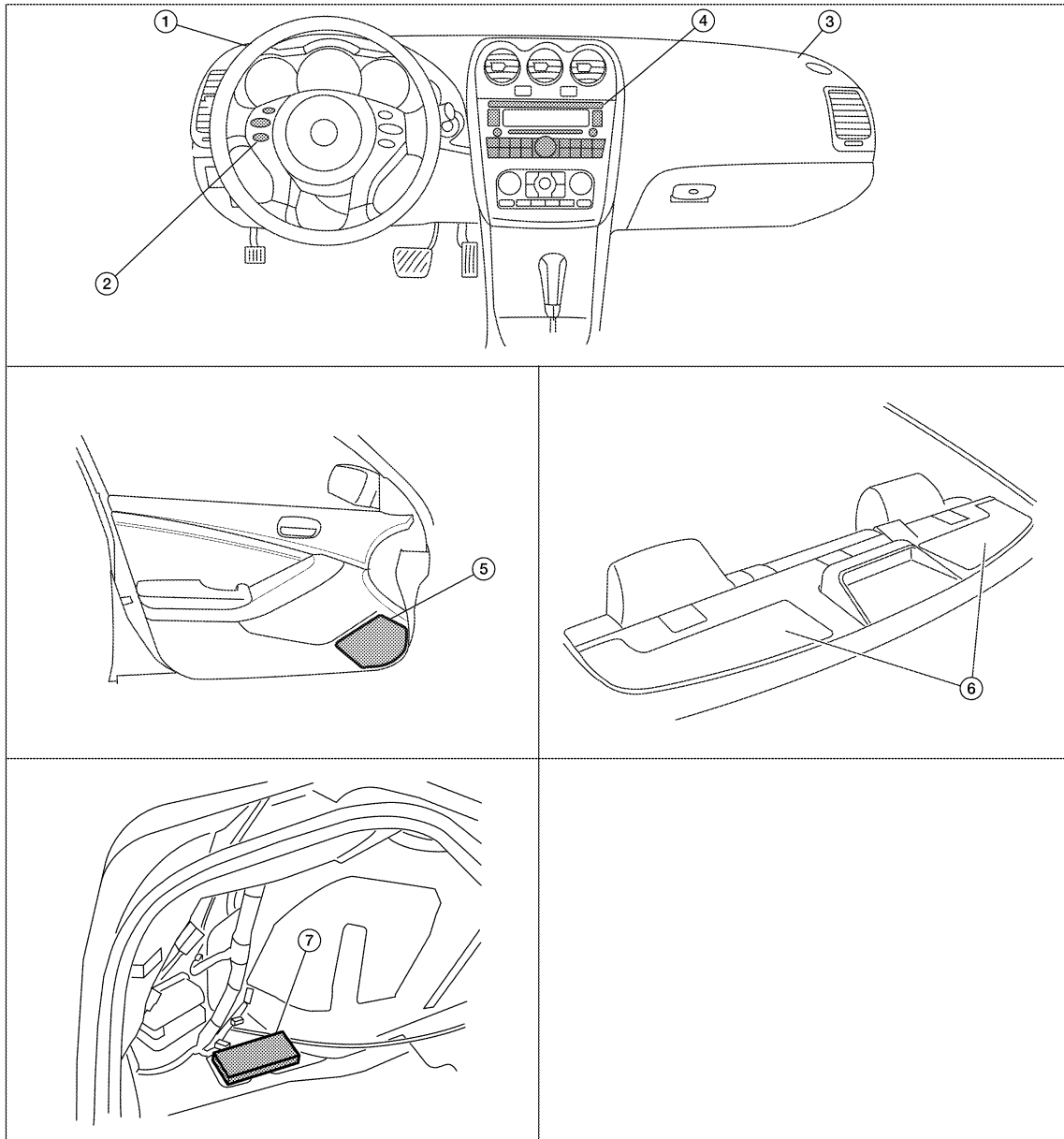

ALNIA0939GB

- |  |  |                                     |
|--|--|-------------------------------------|
| 1. Front tweeter LH M51  | 2. Steering wheel audio control switches | 3. Front tweeter RH M52             |
| 4. Audio unit M43, M45, M81                                    | 5. Door speaker<br>LH D3<br>RH D103      | 6. Rear speaker<br>RH B44<br>LH B26 |
| 7. Satellite radio tuner B57, B58 (with satellite radio tuner) |  |                                     |

## Component Description

INFOID:000000001830429

Part name	Description
Audio unit	Controls audio system and satellite radio system functions
Steering wheel audio control switches	<ul style="list-style-type: none"> <li>Each audio operation can be operated</li> <li>Steering switch signal (operation signal) is output to AV control unit</li> </ul>



# AUDIO SYSTEM (COUPE)

< FUNCTION DIAGNOSIS >

[BASE AUDIO]

Part name	Description	
Door speakers	<ul style="list-style-type: none"><li>• Outputs audio signal from audio unit</li><li>• Outputs high, mid and low range sounds</li></ul>	A
Front tweeters	<ul style="list-style-type: none"><li>• Outputs audio signal from audio unit</li><li>• Outputs high range sounds</li></ul>	B
Rear speakers	<ul style="list-style-type: none"><li>• Outputs audio signal from audio unit</li><li>• Outputs high, mid and low range sounds</li></ul>	C
Satellite radio tuner	<ul style="list-style-type: none"><li>• Receives radio signals from satellite antenna</li><li>• Sends audio signals to audio unit</li></ul>	
Satellite antenna	Audio signal (satellite radio) is received and output to audio unit.	D

E

F

G

H

I

J

K

L

M

AV

O

P

## AUDIO SYSTEM (SEDAN)

### System Diagram

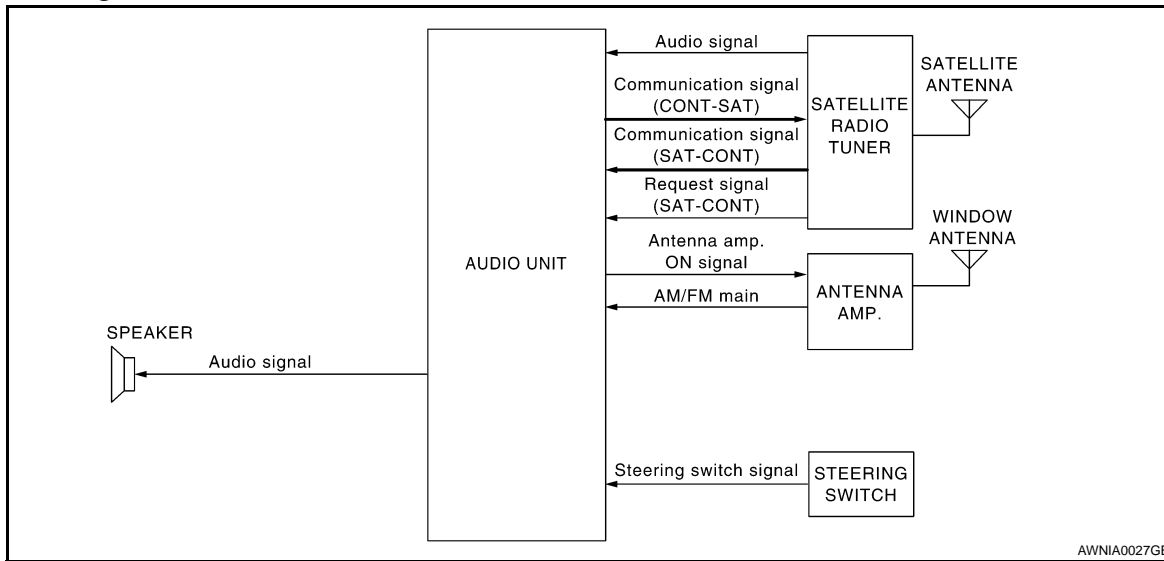

### System Description

INFOID:000000003221748

#### AUDIO SYSTEM

The audio system consists of the following components

- Audio unit
- Window antenna
- Steering wheel audio control switches
- Front door speakers
- Tweeters
- Rear speakers

When the audio system is on, radio signals are received by the window antenna. The audio unit then sends audio signals to the front door speakers, tweeters and rear speakers.

Refer to Owner's Manual for audio system operating instructions.

#### SATELLITE RADIO SYSTEM

The satellite radio system consists of the following components

- Roof antenna (satellite)
- Satellite radio tuner

When the satellite radio system is on, radio signals are supplied to the satellite radio tuner from the satellite antenna. The satellite radio tuner then sends audio signals to the audio unit.

Refer to Owner's Manual for satellite radio system operating instructions.

# AUDIO SYSTEM (SEDAN)

< FUNCTION DIAGNOSIS >

[BASE AUDIO]

## Component Parts Location

INFOID:000000003221749

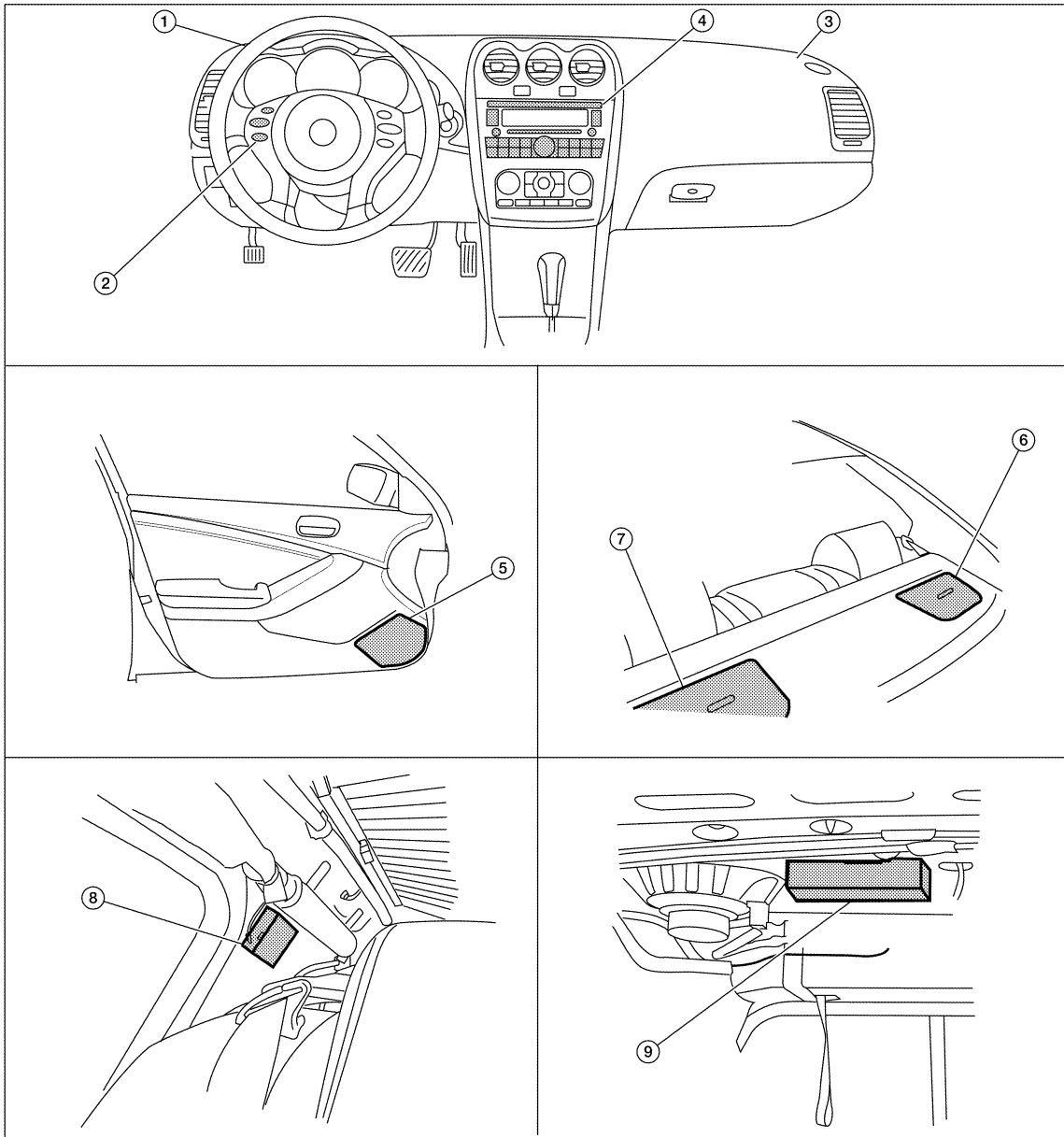

ALNIA0073GB

- |                             |   |   |
|-----------------------------|---|---|
| 1. Tweeter LH M51           | 2. Steering wheel audio control switches  | 3. Tweeter RH M52   |
| 4. Audio unit M43, M45, M81 | 5. Front door speaker<br>LH D3<br>RH D103 | 6. Rear speaker<br>RH B44   |
| 7. Rear speaker<br>LH B26   | 8. Antenna amp. M502                      | 9. Satellite radio tuner B57, B58 (with<br>satellite radio tuner) |

## Component Description

INFOID:000000003221750

Part name	Description
Audio unit	Controls audio system and satellite radio system functions
Steering wheel audio control switches	<ul style="list-style-type: none"> <li>Each audio operation can be operated</li> <li>Steering switch signal (operation signal) is output to AV control unit</li> </ul>

A  
B  
C  
D  
E  
F  
G  
H  
I  
J  
K  
L  
M

AV

O

P

## AUDIO SYSTEM (SEDAN)

< FUNCTION DIAGNOSIS >

[BASE AUDIO]

Part name	Description
Front door speakers	<ul style="list-style-type: none"><li>• Outputs audio signal from audio unit</li><li>• Outputs high, mid and low range sounds</li></ul>
Tweeters	<ul style="list-style-type: none"><li>• Outputs audio signal from audio unit</li><li>• Outputs high range sounds</li></ul>
Rear speakers	<ul style="list-style-type: none"><li>• Outputs audio signal from audio unit</li><li>• Outputs high, mid and low range sounds</li></ul>
Satellite radio tuner	<ul style="list-style-type: none"><li>• Receives radio signals from satellite antenna</li><li>• Sends audio signals to audio unit</li></ul>
Satellite antenna	Audio signal (satellite radio) is received and output to audio unit.

## DIAGNOSIS SYSTEM (AUDIO UNIT)

### Diagnosis Description

INFOID:000000001830430

Self-diagnosis mode can check the following items.

- Audio unit hardware/software versions
- Continuity of each speaker channel
- Continuity of each audio unit switch

### OPERATION PROCEDURE

1. Turn ignition switch to the ACC position.
2. Turn the audio unit off.
3. While pressing the "AUDIO" button, turn the volume control dial clockwise or counterclockwise 30 clicks or more. When the self-diagnosis mode is started, a short beep will be heard.

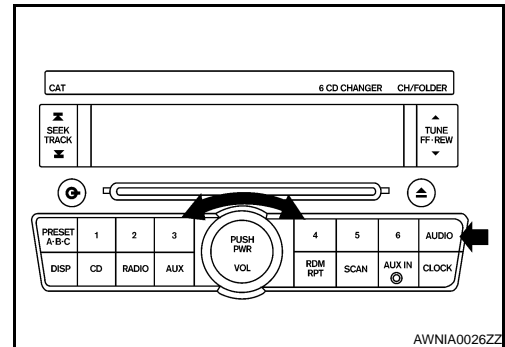

4. Initially, all display segments will be illuminated.

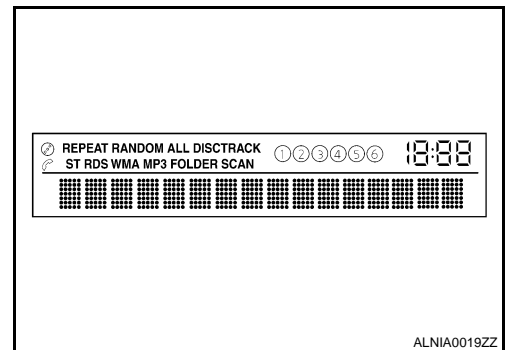

### Version Check

1. Press the "AUDIO" switch to enter version diagnostics. "Software" (audio software version) is displayed.

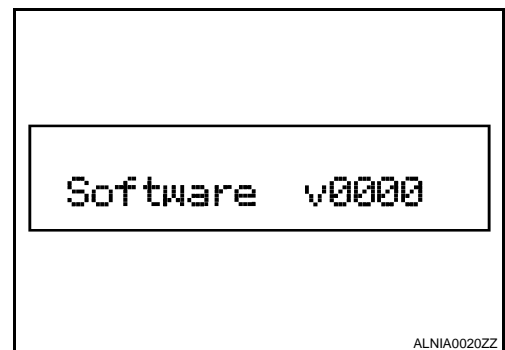

A  
B  
C  
D  
E  
F  
G  
H  
I  
J  
K  
L  
M  
AV  
O  
P

# DIAGNOSIS SYSTEM (AUDIO UNIT)

< FUNCTION DIAGNOSIS >

[BASE AUDIO]

2. Press the "AUDIO" switch again to display the "Hardware" (audio hardware version).

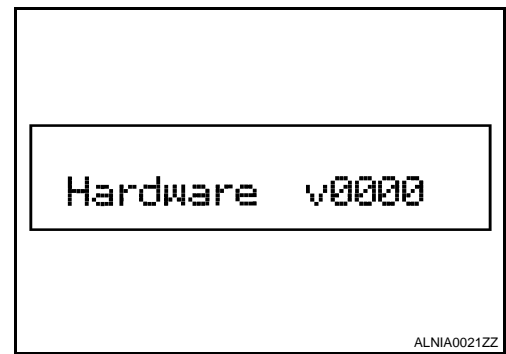

3. Press the "AUDIO" switch again to display the "CD Mech" (CD mechanism version).



4. Press the "AUDIO" switch again to display the "SDARS" (satellite radio version).



## Channel Check Diagnostics

When all segments are illuminated, press the "TUNE" up switch to enter channel check diagnostics. The self-diagnostic function will then send a tone to each channel (FL, RL, RR, FR) for 1 second.

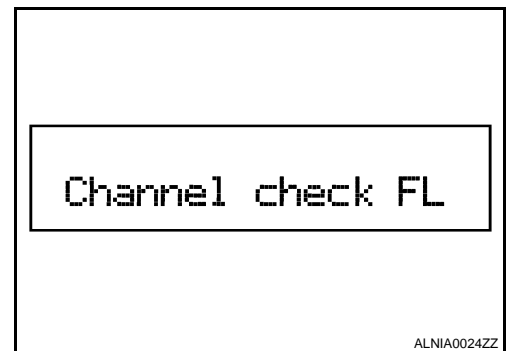

## Button Check Diagnostics

# DIAGNOSIS SYSTEM (AUDIO UNIT)

< FUNCTION DIAGNOSIS >

[BASE AUDIO]

When all segments are illuminated, press the "TUNE" down switch to enter button check diagnostics. When each audio unit switch is pressed, a tone will sound and the switch name will be displayed.

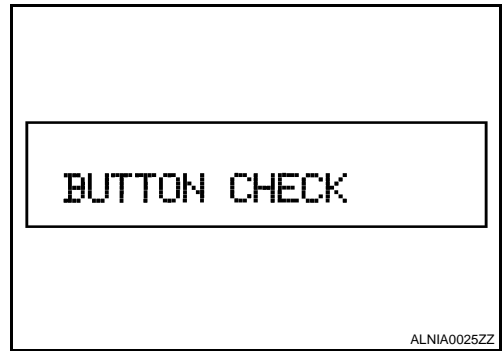

- A
- B
- C
- D
- E
- F
- G
- H
- I
- J
- K
- L
- M
- AV
- O
- P

# POWER SUPPLY AND GROUND CIRCUIT (COUPE)

< COMPONENT DIAGNOSIS >

[BASE AUDIO]

## COMPONENT DIAGNOSIS

### POWER SUPPLY AND GROUND CIRCUIT (COUPE)

#### AUDIO UNIT

#### AUDIO UNIT : Diagnosis Procedure

INFOID:000000001830431

#### 1.CHECK FUSES

Check that the following fuses are not blown.

Unit	Terminals	Signal name	Fuse No.
Audio unit	19	Battery power	24
	7	Ignition switch ACC or ON	19

Are the fuses OK?

YES >> GO TO 2

NO >> If fuse is blown, be sure to eliminate cause of malfunction before installing new fuse.

#### 2.POWER SUPPLY CIRCUIT CHECK

1. Disconnect audio unit connector M43.
2. Check voltage between the audio unit connector M43 and ground.

(+) Connector		(-)	OFF	ACC	ON
Terminal					
M43	19	Ground	Battery voltage	Battery voltage	Battery voltage
	7	Ground	0V	Battery voltage	Battery voltage

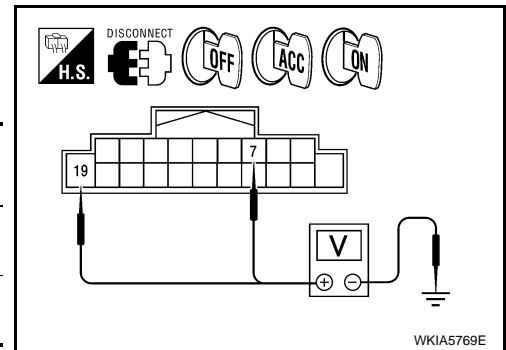

Are the voltage results as specified?

YES >> GO TO 3

NO >> • Check connector housings for disconnected or loose terminals.  
• Repair harness or connector.

#### 3.GROUND CIRCUIT CHECK

Inspect audio unit case ground.

Does case ground pass inspection?

YES >> Inspection End.

NO >> Repair audio unit case ground.

#### SATELLITE RADIO TUNER

#### SATELLITE RADIO TUNER : Diagnosis Procedure

INFOID:000000001830432

#### 1.CHECK FUSES

Check that the following fuses are not blown.

Unit	Terminals	Signal name	Fuse No.
Satellite radio tuner (factory installed)	32	Battery power	24
	36	Ignition switch ACC or ON	19

Are the fuses OK?

YES >> GO TO 2

NO >> If fuse is blown, be sure to eliminate cause of malfunction before installing new fuse.

#### 2.POWER SUPPLY CIRCUIT CHECK



# POWER SUPPLY AND GROUND CIRCUIT (COUPE)

[BASE AUDIO]

## < COMPONENT DIAGNOSIS >

1. Turn ignition switch OFF.
2. Disconnect satellite radio tuner (factory installed) connector B57.
3. Check voltage between the satellite radio tuner (factory installed) and ground.

(+)		(-)	OFF	ACC	ON
Connector	Terminal				
B57	32	Ground	Battery voltage	Battery voltage	Battery voltage
	36	Ground	0V	Battery voltage	Battery voltage

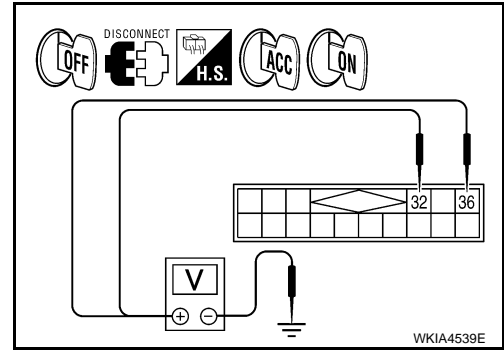

### Are the voltage results as specified?

- YES >> GO TO 3  
 NO >> • Check connector housings for disconnected or loose terminals.  
 • Repair harness or connector.

## 3. GROUND CIRCUIT CHECK

Inspect satellite radio tuner (factory installed) case ground.

### Does case ground pass inspection?

- YES >> Inspection End.  
 NO >> Repair satellite radio tuner (factory installed) case ground.

A  
B  
C  
D  
E  
F  
G  
H  
I  
J  
K  
L  
M  
O  
P

AV

# POWER SUPPLY AND GROUND CIRCUIT (SEDAN)

< COMPONENT DIAGNOSIS >

[BASE AUDIO]

## POWER SUPPLY AND GROUND CIRCUIT (SEDAN)

### AUDIO UNIT

#### AUDIO UNIT : Diagnosis Procedure

INFOID:000000003221751

#### 1.CHECK FUSES

Check that the following fuses are not blown.

Unit	Terminals	Signal name	Fuse No.
Audio unit	19	Battery power	24
	7	Ignition switch ACC or ON	19

Are the fuses OK?

YES >> GO TO 2

NO >> If fuse is blown, be sure to eliminate cause of malfunction before installing new fuse.

#### 2.POWER SUPPLY CIRCUIT CHECK

1. Disconnect audio unit connector M43.
2. Check voltage between the audio unit connector M43 and ground.

(+) Connector		(-) Terminal	OFF	ACC	ON
M43	19	Ground	Battery voltage	Battery voltage	Battery voltage
	7	Ground	0V	Battery voltage	Battery voltage

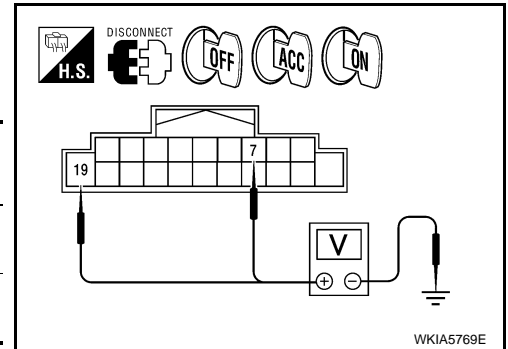

Are the voltage results as specified?

YES >> GO TO 3

NO >> • Check connector housings for disconnected or loose terminals.  
• Repair harness or connector.

#### 3.GROUND CIRCUIT CHECK

Inspect audio unit case ground.

Does case ground pass inspection?

YES >> Inspection End.

NO >> Repair audio unit case ground.

### SATELLITE RADIO TUNER

#### SATELLITE RADIO TUNER : Diagnosis Procedure

INFOID:000000003221753

#### 1.CHECK FUSES

Check that the following fuses are not blown.

Unit	Terminals	Signal name	Fuse No.
Satellite radio tuner (factory installed)	32	Battery power	24
	36	Ignition switch ACC or ON	19

Are the fuses OK?

YES >> GO TO 2

NO >> If fuse is blown, be sure to eliminate cause of malfunction before installing new fuse.

#### 2.POWER SUPPLY CIRCUIT CHECK

1. Turn ignition switch OFF.
2. Disconnect satellite radio tuner (factory installed) connector B123.

# POWER SUPPLY AND GROUND CIRCUIT (SEDAN)

< COMPONENT DIAGNOSIS >

[BASE AUDIO]

3. Check voltage between the satellite radio tuner (factory installed) and ground.

(+)		(-)	OFF	ACC	ON
Connector	Terminal				
B123	32	Ground	Battery voltage	Battery voltage	Battery voltage
	36	Ground	0V	Battery voltage	Battery voltage

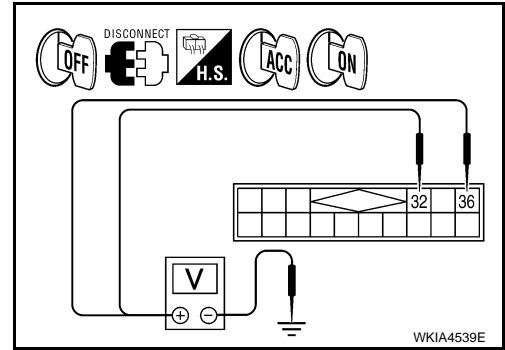

Are the voltage results as specified?

YES >> GO TO 3

NO >> • Check connector housings for disconnected or loose terminals.  
• Repair harness or connector.

## 3. GROUND CIRCUIT CHECK

Inspect satellite radio tuner (factory installed) case ground.

Does case ground pass inspection?

YES >> Inspection End.

NO >> Repair satellite radio tuner (factory installed) case ground.

A  
B  
C  
D  
E  
F  
G  
H  
I  
J  
K  
L  
M  
N  
O  
P

AV

# DOOR SPEAKER (COUPE)

< COMPONENT DIAGNOSIS >

[BASE AUDIO]

## DOOR SPEAKER (COUPE)

### Description

INFOID:000000001830433

The audio unit sends audio signals to the door speakers using the door speaker circuits.

### Diagnosis Procedure

INFOID:000000001830434

#### 1. HARNESS CHECK

1. Disconnect audio unit connector M43 (A) and suspect speaker connector (B).
2. Check continuity between audio unit harness connector M43 (A) terminal and suspect speaker harness connector (B) terminal.

A		B		Continuity
Connector	Terminal	Connector	Terminal	
M43	2	D3	1	Yes
	3		2	
	11	D103	1	
	12		2	

3. Check continuity between audio unit harness connector M43 (A) terminal and ground.

A		—	Continuity
Connector	Terminal		
A	2	Ground	No
	3		
	11		
	12		

Are continuity results as specified?

YES >> GO TO 2

- NO >> • Check connector housings for disconnected or loose terminals.  
• Repair harness or connector.

#### 2. DOOR SPEAKER SIGNAL CHECK

1. Connect audio unit connector and front speaker connector.
2. Turn ignition switch to ACC.
3. Push "POWER" switch.

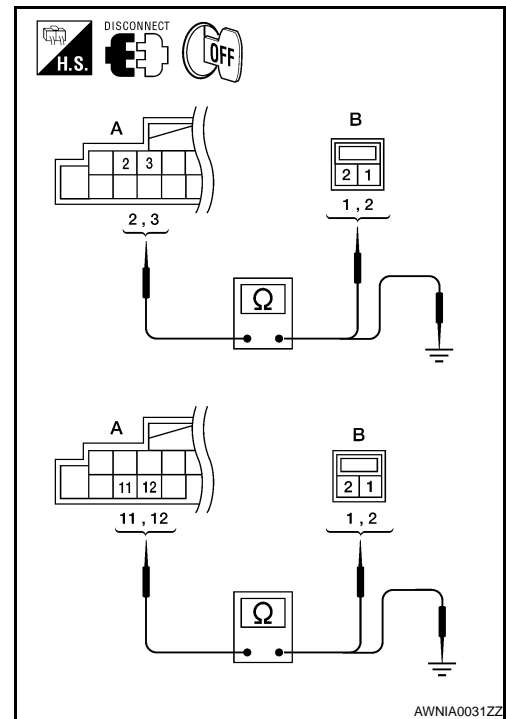

# DOOR SPEAKER (COUPE)

## < COMPONENT DIAGNOSIS >

[BASE AUDIO]

4. Check the signal between audio unit harness connector terminals with CONSULT-III or oscilloscope.

Con- nector	(+) Terminal		(-) Terminal	Condition	Reference signal
	2	3	11		
M43	11	12		Receive audio sig- nal	<p style="text-align: right; font-size: small;">SKIA0177E</p>

Is the audio signal voltage as specified?

- YES >> Replace speaker. Refer to [AV-72. "Removal and Installation"](#).
- NO >> Replace audio unit. Refer to [AV-70. "Removal and Installation"](#).

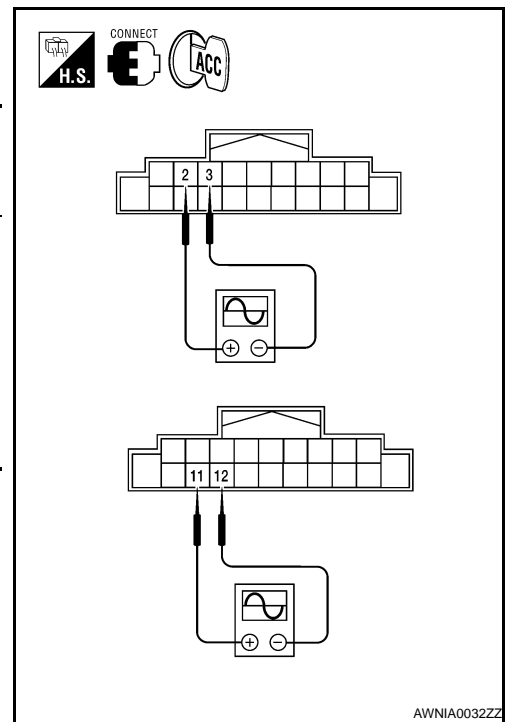

A  
B  
C  
D  
E  
F  
G  
H  
I  
J  
K  
L  
M  
O  
P

AV

# FRONT DOOR SPEAKER (SEDAN)

< COMPONENT DIAGNOSIS >

[BASE AUDIO]

## FRONT DOOR SPEAKER (SEDAN)

### Description

INFOID:000000003188260

The audio unit sends audio signals to the front door speakers using the door speaker circuits.

### Diagnosis Procedure

INFOID:000000003188261

#### 1. HARNESS CHECK

1. Disconnect audio unit connector M43 (A) and suspect speaker connector (B).
2. Check continuity between audio unit harness connector M43 (A) terminal and suspect speaker harness connector (B) terminal.

A		B		Continuity
Connector	Terminal	Connector	Terminal	
M43	2	D3	1	Yes
	3		2	
	11	D103	1	
	12		2	

3. Check continuity between audio unit harness connector M43 (A) terminal and ground.

A		—	Continuity
Connector	Terminal		
A	2	Ground	No
	3		
	11		
	12		

Are continuity results as specified?

YES >> GO TO 2

- NO >> • Check connector housings for disconnected or loose terminals.  
• Repair harness or connector.

#### 2. FRONT DOOR SPEAKER SIGNAL CHECK

1. Connect audio unit connector and front speaker connector.
2. Turn ignition switch to ACC.
3. Push "POWER" switch.

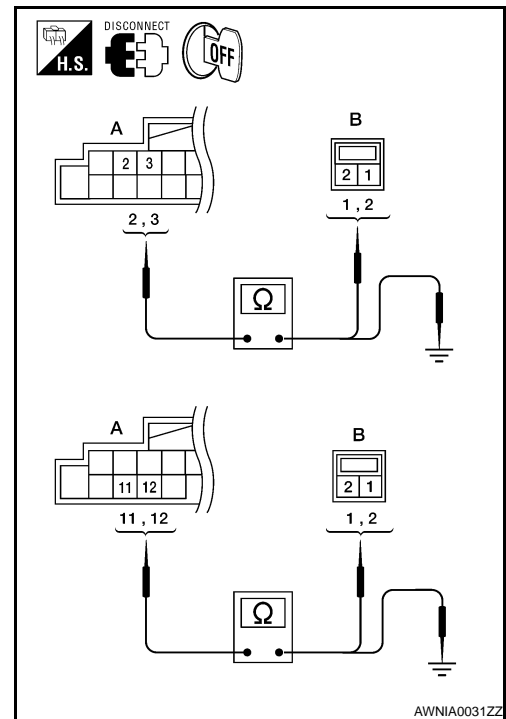

# FRONT DOOR SPEAKER (SEDAN)

< COMPONENT DIAGNOSIS >

[BASE AUDIO]

4. Check the signal between audio unit harness connector terminals with CONSULT-III or oscilloscope.

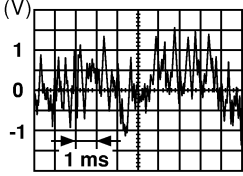
Con- nector	(+) (-)		Condition	Reference signal
	Terminal	Terminal		
M43	2	3	Receive audio sig- nal	
	11	12		

Is the audio signal voltage as specified?

- YES >> Replace speaker. Refer to [AV-72. "Removal and Installation"](#).
- NO >> Replace audio unit. Refer to [AV-70. "Removal and Installation"](#).

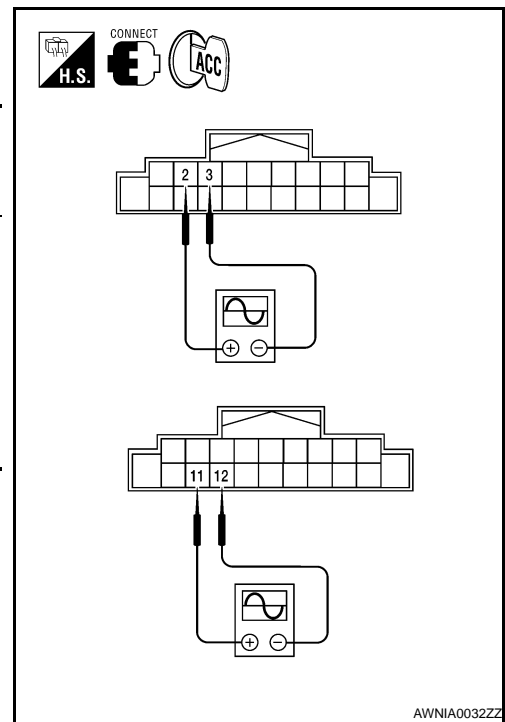

A  
B  
C  
D  
E  
F  
G  
H  
I  
J  
K  
L  
M

AV

O  
P

# FRONT TWEETER (COUPE)

< COMPONENT DIAGNOSIS >

[BASE AUDIO]

## FRONT TWEETER (COUPE)

### Description

INFOID:000000001830435

The audio unit sends audio signals to the front tweeters using the door speaker circuits.

### Diagnosis Procedure

INFOID:000000001830436

#### 1. HARNESS CHECK

1. Disconnect audio unit connector M43 (A) and suspect tweeter connector (B).
2. Check continuity between audio unit harness connector M43 (A) and suspect tweeter harness connector (B).

A		B		Continuity
Connector	Terminal	Connector	Terminal	
M43	2	M51	1	Yes
	3		2	
	11	M52	1	
	12		2	

3. Check continuity between audio unit harness connector M43 (A) and ground.

A		—	Continuity
Connector	Terminal		
M43	2	Ground	No
	3		
	11		
	12		

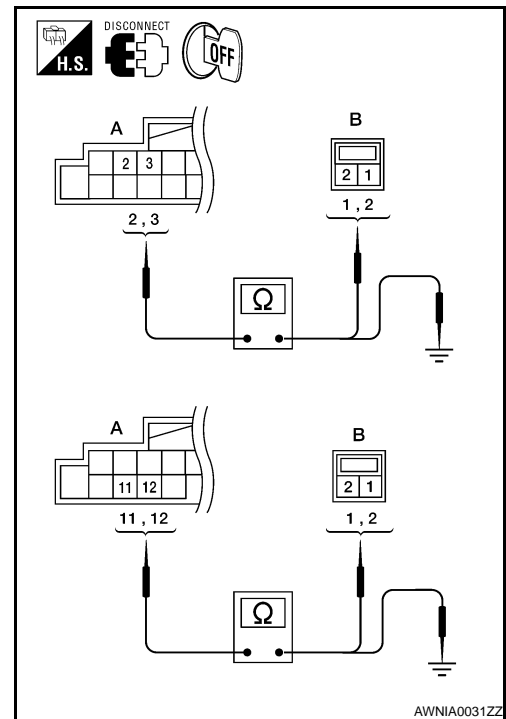

AVNIA0031ZZ

Are the continuity results as specified?

YES >> GO TO 2

- NO >> • Check connector housings for disconnected or loose terminals.  
• Repair harness or connector.

#### 2. FRONT TWEETER SIGNAL CHECK



# FRONT TWEETER (COUPE)

[BASE AUDIO]

## < COMPONENT DIAGNOSIS >

1. Connect audio unit connector and tweeter connector.
2. Turn ignition switch to ACC.
3. Push "POWER" switch.
4. Check the signal between audio unit harness connector terminals with CONSULT-III or oscilloscope.

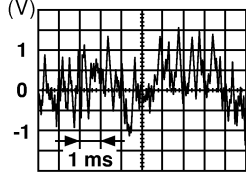
Con- nector	(+)		(-)		Condition	Reference signal
	Terminal	Terminal	Terminal	Terminal		
M43	2	3	11	12	Receive audio sig- nal	 <p style="text-align: right; font-size: small;">SKIA0177E</p>
	11	12				

Is the audio signal voltage as specified?

- YES >> Replace tweeter. Refer to [AV-71](#), "[Removal and Installation](#)".
- NO >> Replace audio unit. Refer to [AV-70](#), "[Removal and Installation](#)".

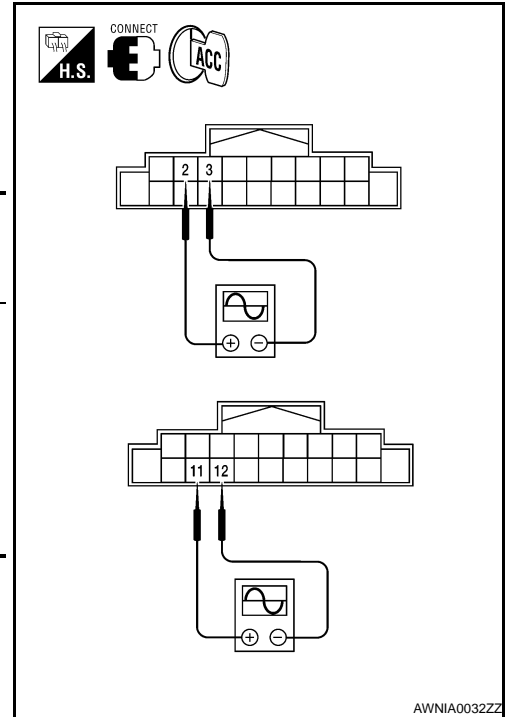

A  
B  
C  
D  
E  
F  
G  
H  
I  
J  
K  
L  
M  
O  
P

AV

# TWEETER (SEDAN)

< COMPONENT DIAGNOSIS >

[BASE AUDIO]

## TWEETER (SEDAN)

### Description

INFOID:000000003188262

The audio unit sends audio signals to the tweeters using the door speaker circuits.

### Diagnosis Procedure

INFOID:000000003188263

#### 1. HARNESS CHECK

1. Disconnect audio unit connector M43 (A) and suspect tweeter connector (B).
2. Check continuity between audio unit harness connector M43 (A) and suspect tweeter harness connector (B).

A		B		Continuity
Connector	Terminal	Connector	Terminal	
M43	2	M51	1	Yes
	3		2	
	11	M52	1	
	12		2	

3. Check continuity between audio unit harness connector M43 (A) and ground.

A		—	Continuity
Connector	Terminal		
M43	2	Ground	No
	3		
	11		
	12		

Are the continuity results as specified?

YES >> GO TO 2

- NO >> • Check connector housings for disconnected or loose terminals.  
• Repair harness or connector.

#### 2. TWEETER SIGNAL CHECK

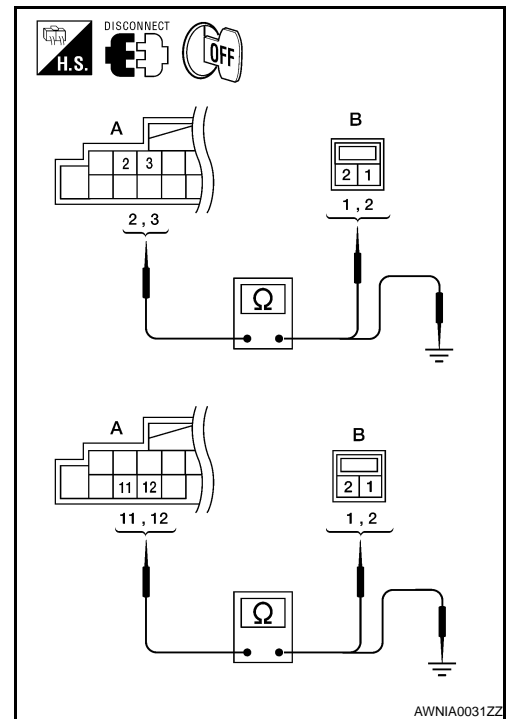

AVNIA0031ZZ

# TWEETER (SEDAN)

## < COMPONENT DIAGNOSIS >

[BASE AUDIO]

1. Connect audio unit connector and tweeter connector.
2. Turn ignition switch to ACC.
3. Push "POWER" switch.
4. Check the signal between audio unit harness connector terminals with CONSULT-III or oscilloscope.

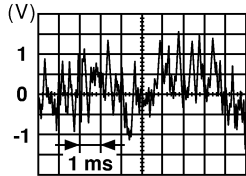
Con- nector	(+)		(-)		Condition	Reference signal
	Terminal	Terminal	Terminal	Terminal		
M43	2	3	11	12	Receive audio sig- nal	 <p style="text-align: right; font-size: small;">SKIA0177E</p>
	11	12				

Is the audio signal voltage as specified?

- YES >> Replace tweeter. Refer to [AV-71](#), "[Removal and Installation](#)".
- NO >> Replace audio unit. Refer to [AV-70](#), "[Removal and Installation](#)".

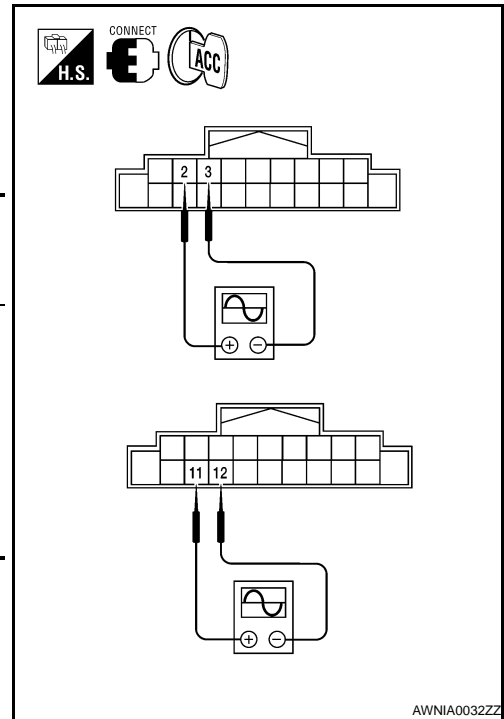

A  
B  
C  
D  
E  
F  
G  
H  
I  
J  
K  
L  
M  
O  
P

AV

# REAR SPEAKER

< COMPONENT DIAGNOSIS >

[BASE AUDIO]

## REAR SPEAKER

### Description

INFOID:000000001830437

The audio unit sends audio signals to the rear speakers using the rear speaker circuits.

### Diagnosis Procedure

INFOID:000000001830438

#### 1. HARNESS CHECK

1. Disconnect audio unit connector M43 (A) and suspect speaker connector.
2. Check continuity between audio unit harness connector M43 (A) and suspect speaker harness connector (B).

A		B		Continuity
Connector	Terminal	Connector	Terminal	
M43	4	B26	1	Yes
	5		2	
	13	B44	1	
	14		2	

3. Check continuity between audio unit harness connector M43 (A) and ground.

A		—	Continuity
Connector	Terminal		
M43	4	Ground	No
	5		
	13		
	14		

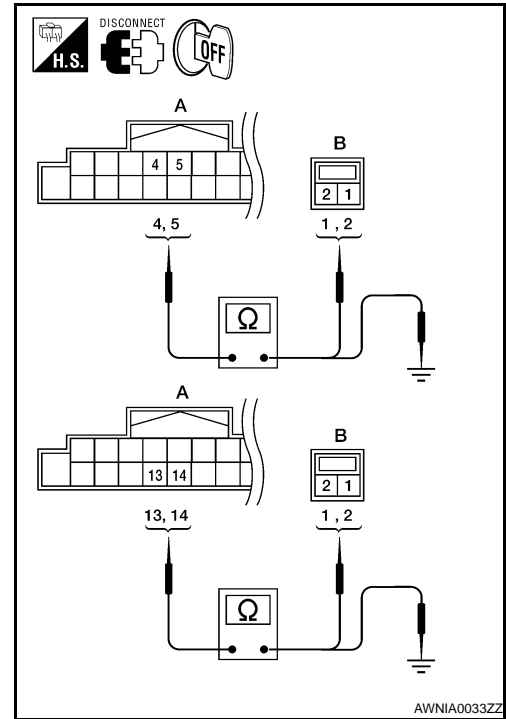

AVNIA0033ZZ

Are the continuity results as specified?

YES >> GO TO 2

- NO >> • Check connector housings for disconnected or loose terminals.  
• Repair harness or connector.

#### 2. REAR SPEAKER SIGNAL CHECK

# REAR SPEAKER

[BASE AUDIO]

## < COMPONENT DIAGNOSIS >

1. Connect audio unit connector and rear tweeter connector.
2. Turn ignition switch to ACC.
3. Push "POWER" switch.
4. Check the signal between audio unit harness connector terminals with CONSULT-III or oscilloscope.

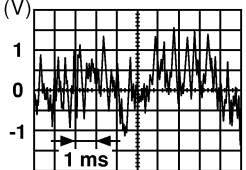
(+)		(-)		Condition	Reference signal
Connector	Terminal	Terminal	Terminal		
M43	4	5	Receive audio signal		
	13	14			

SKIA0177E

Is the audio signal voltage as specified?

- YES >> Replace rear speaker. Refer to [AV-73, "Removal and Installation - Coupe"](#).
- NO >> Replace audio unit. Refer to [AV-70, "Removal and Installation"](#).

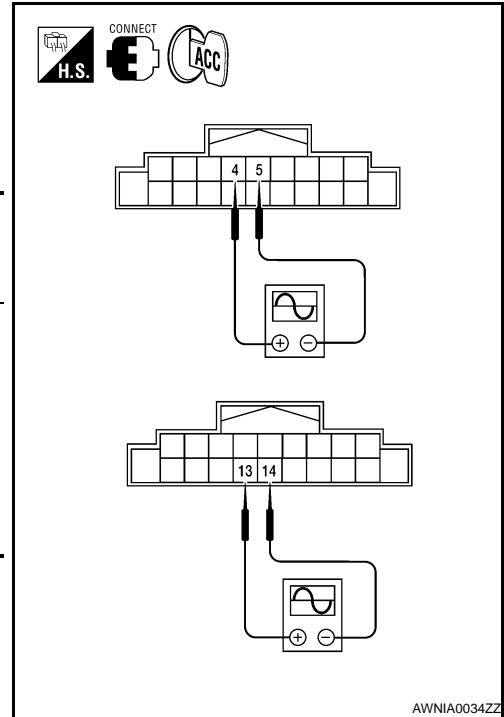

A  
B  
C  
D  
E  
F  
G  
H  
I  
J  
K  
L  
M  
O  
P

AV

# STEERING SWITCH

< COMPONENT DIAGNOSIS >

[BASE AUDIO]

## STEERING SWITCH

### Description

INFOID:000000001830439

When one of the steering wheel audio control switches is pushed, the resistance in steering switch circuit changes depending on which button is pushed.

### Diagnosis Procedure

INFOID:000000001830440

#### 1. CHECK STEERING SWITCH RESISTANCE

1. Disconnect steering switch connector M88.
2. Check resistance between steering switch connector terminals.

Terminal	Signal name	Condition	Resistance (Ω) (Approx.)
15	Seek (down)	Depress (station) down switch.	165
	Volume (down)	Depress volume down switch.	487
14	Seek (up)	Depress (station) up switch.	165
	Source	Depress source switch.	0
	Volume (up)	Depress volume up switch.	487

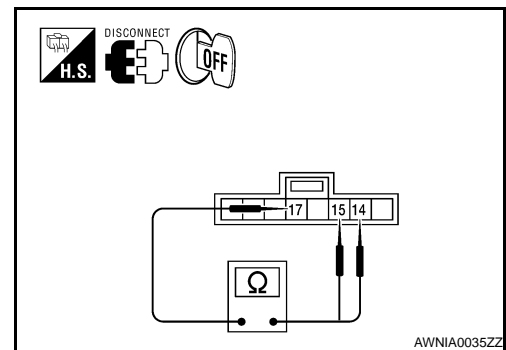

Do the steering switches check OK?

YES >> GO TO 2

NO >> Replace steering switch. Refer to [AV-216. "Removal and Installation"](#).

#### 2. CHECK HARNESS

1. Turn ignition switch OFF.
2. Disconnect audio unit connector M43 and spiral cable connector M30.
3. Check continuity between audio unit harness connector M43 (A) and spiral cable harness connector M30 (B).

A		B		Continuity
Connector	Terminal	Connector	Terminal	
M43	6	M30	31	Yes
	16		24	
	15		33	

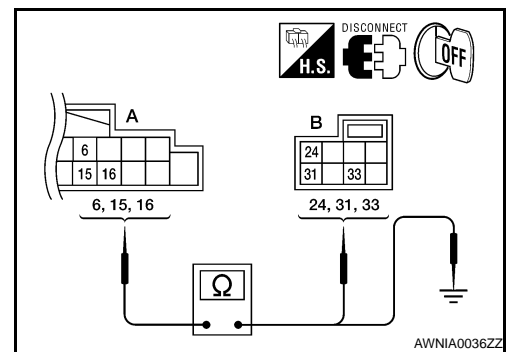

4. Check continuity between audio unit connector M43 (A) and ground.

A		—	Continuity
Connector	Terminal		
M43	6	Ground	No
	15		
	16		

Are the continuity results as specified?

YES >> GO TO 3

NO >> Repair harness.

#### 3. SPIRAL CABLE CHECK

# STEERING SWITCH

[BASE AUDIO]

## < COMPONENT DIAGNOSIS >

1. Disconnect spiral cable connector M88.
2. Check continuity between spiral cable harness connector M30 (A) and M88 (B).

A		B		Continuity
Connector	Terminal	Connector	Terminal	
M30	24	M88	14	Yes
	31		15	
	33		17	

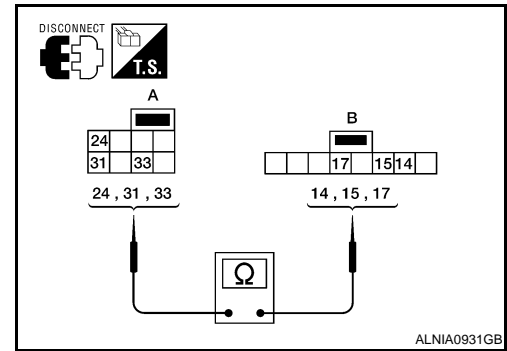

Does the spiral cable check OK?

- YES >> Inspection End.  
 NO >> Replace spiral cable. Refer to [SR-6. "Removal and Installation"](#).

A  
B  
C  
D  
E  
F  
G  
H  
I  
J  
K  
L  
M

AV

O  
P

# COMMUNICATION SIGNAL CIRCUIT (COUPE)

< COMPONENT DIAGNOSIS >

[BASE AUDIO]

## COMMUNICATION SIGNAL CIRCUIT (COUPE)

### SATELLITE RADIO TUNER

#### SATELLITE RADIO TUNER : Description

INFOID:000000001830441

Communication signals are exchanged between the audio unit and satellite radio tuner using the communication circuits.

#### SATELLITE RADIO TUNER : Diagnosis Procedure

INFOID:000000001830442

#### 1.CHECK HARNESS - 1

1. Turn ignition switch OFF.
2. Disconnect satellite radio tuner (factory installed) connector B57 and audio unit connector M45.
3. Check continuity between satellite radio tuner (factory installed) harness connector B57 (A) terminal 28 and audio unit harness connector M45 (B) terminal 38.

**Continuity should exist.**

4. Check continuity between satellite radio tuner (factory installed) harness connector B57 (A) terminal 28 and ground.

**Continuity should not exist.**

Are continuity results as specified?

YES >> GO TO 2

NO >> Repair harness or connector.

#### 2.CHECK HARNESS - 2

1. Check continuity between satellite radio tuner (factory installed) harness connector B57 (A) terminal 29 and audio unit harness connector M45 (B) terminal 39.

**Continuity should exist.**

2. Check continuity between satellite radio tuner (factory installed) harness connector B57 (A) terminal 29 and ground.

**Continuity should not exist.**

Are continuity results as specified?

YES >> GO TO 3

NO >> Repair harness or connector.

#### 3.CHECK HARNESS - 3

1. Check continuity between satellite radio tuner (factory installed) harness connector B57 (A) terminal 30 and audio unit harness connector M45 (B) terminal 40.

**Continuity should exist.**

2. Check continuity between satellite radio tuner (factory installed) harness connector B57 (A) terminal 30 and ground.

**Continuity should not exist.**

Are continuity results as specified?

YES >> GO TO 4

NO >> Repair harness or connector.

#### 4.CHECK REQ1 SIGNAL

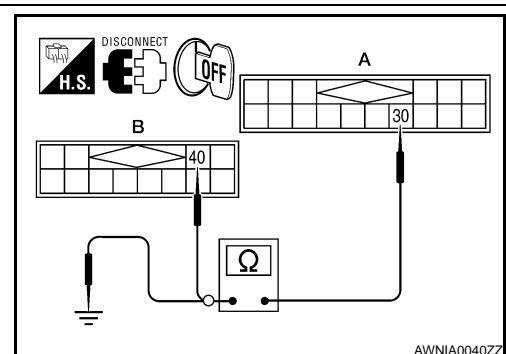
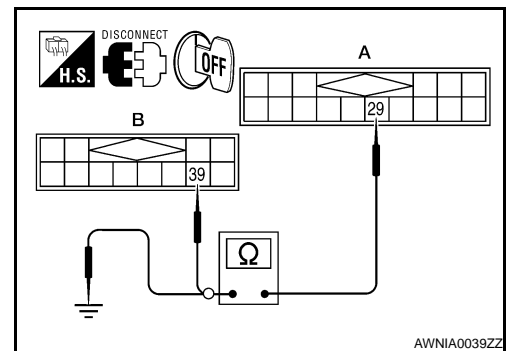
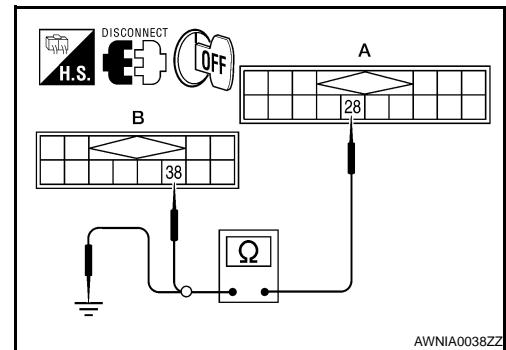



# COMMUNICATION SIGNAL CIRCUIT (COUPE)

< COMPONENT DIAGNOSIS >

[BASE AUDIO]

1. Connect satellite radio tuner (factory installed) connector and audio unit connector.
2. Turn ignition switch to ACC
3. Check signal between satellite radio tuner (factory installed) harness connector B57 terminal 28 and ground with CONSULT-III or oscilloscope.

## 28 - Ground

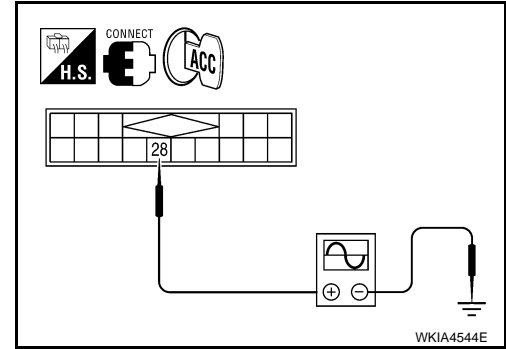
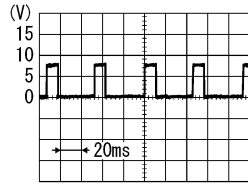

Are voltage readings as specified?

YES >> GO TO 5

NO >> Replace audio unit. Refer to [AV-70, "Removal and Installation"](#).

## 5.CHECK TXD SIGNAL

Check signal between satellite radio tuner (factory installed) harness connector B57 terminal 29 and ground with CONSULT-III or oscilloscope.

## 29 - Ground

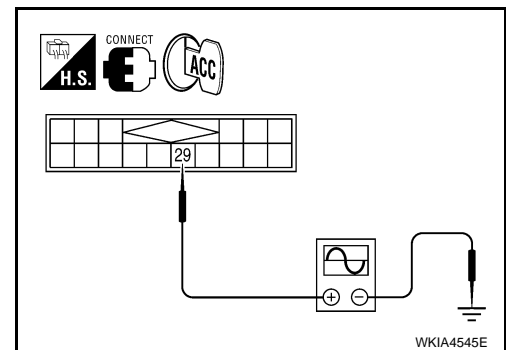
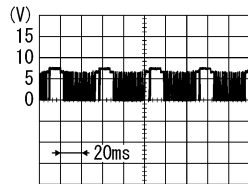

Are the voltage readings as specified?

YES >> GO TO 6

NO >> Replace satellite radio tuner.

## 6.CHECK RXD SIGNAL

Check signal between satellite radio tuner (factory installed) harness connector B57 terminal 30 and ground with CONSULT-III or oscilloscope.

## 30 - Ground

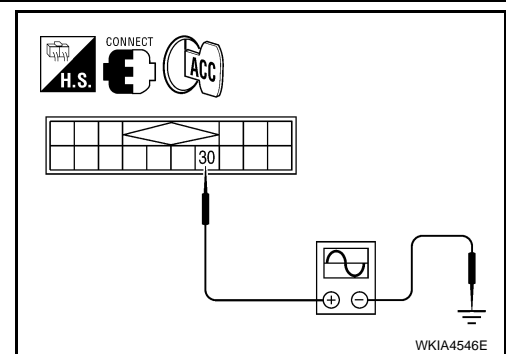
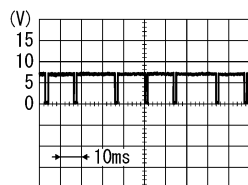

Are the voltage readings as specified?

YES >> Replace satellite radio tuner.

NO >> Replace audio unit. Refer to [AV-70, "Removal and Installation"](#).

A  
B  
C  
D  
E  
F  
G  
H  
I  
J  
K  
L  
M  
AV  
O  
P

## COMMUNICATION SIGNAL CIRCUIT (SEDAN) SATELLITE RADIO TUNER

### SATELLITE RADIO TUNER : Description

INFOID:000000003221754

Communication signals are exchanged between the audio unit and satellite radio tuner using the communication circuits.

### SATELLITE RADIO TUNER : Diagnosis Procedure

INFOID:000000003221756

#### 1. CHECK HARNESS - 1

1. Turn ignition switch OFF.
2. Disconnect satellite radio tuner (factory installed) connector B123 and audio unit connector M45.
3. Check continuity between satellite radio tuner (factory installed) harness connector B123 (A) terminal 28 and audio unit harness connector M45 (B) terminal 38.

**Continuity should exist.**

4. Check continuity between satellite radio tuner (factory installed) harness connector B123 (A) terminal 28 and ground.

**Continuity should not exist.**

Are continuity results as specified?

- YES >> GO TO 2  
NO >> Repair harness or connector.

#### 2. CHECK HARNESS - 2

1. Check continuity between satellite radio tuner (factory installed) harness connector B123 (A) terminal 29 and audio unit harness connector M45 (B) terminal 39.

**Continuity should exist.**

2. Check continuity between satellite radio tuner (factory installed) harness connector B123 (A) terminal 29 and ground.

**Continuity should not exist.**

Are continuity results as specified?

- YES >> GO TO 3  
NO >> Repair harness or connector.

#### 3. CHECK HARNESS - 3

1. Check continuity between satellite radio tuner (factory installed) harness connector B123 (A) terminal 30 and audio unit harness connector M45 (B) terminal 40.

**Continuity should exist.**

2. Check continuity between satellite radio tuner (factory installed) harness connector B123 (A) terminal 30 and ground.

**Continuity should not exist.**

Are continuity results as specified?

- YES >> GO TO 4  
NO >> Repair harness or connector.

#### 4. CHECK REQ1 SIGNAL

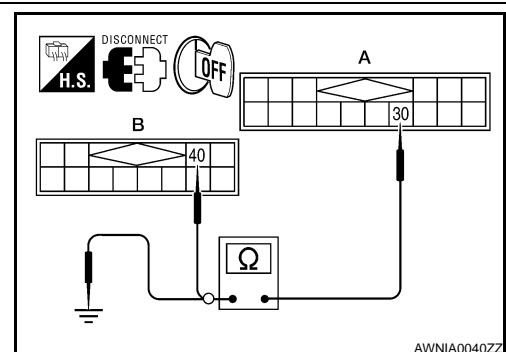
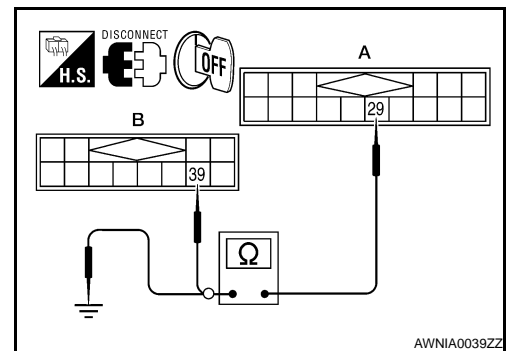
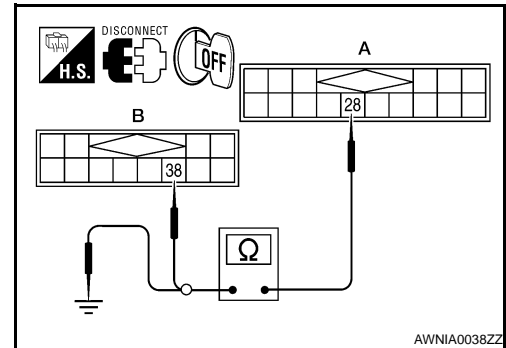

# COMMUNICATION SIGNAL CIRCUIT (SEDAN)

< COMPONENT DIAGNOSIS >

[BASE AUDIO]

1. Connect satellite radio tuner (factory installed) connector and audio unit connector.
2. Turn ignition switch to ACC
3. Check signal between satellite radio tuner (factory installed) harness connector B123 terminal 28 and ground with CONSULT-III or oscilloscope.

## 28 - Ground

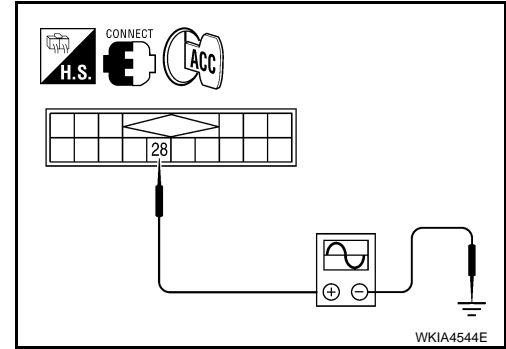
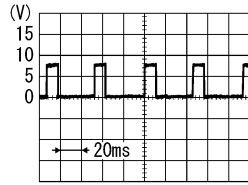

Are voltage readings as specified?

YES >> GO TO 5

NO >> Replace audio unit. Refer to [AV-70, "Removal and Installation"](#).

## 5.CHECK TXD SIGNAL

Check signal between satellite radio tuner (factory installed) harness connector B123 terminal 29 and ground with CONSULT-III or oscilloscope.

## 29 - Ground

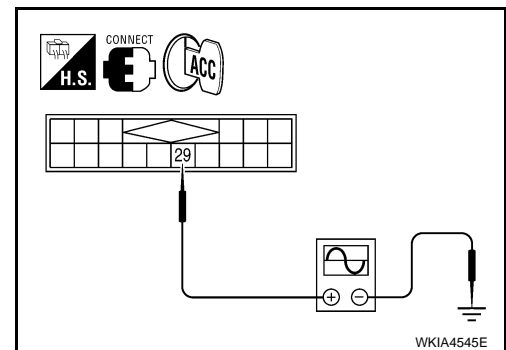
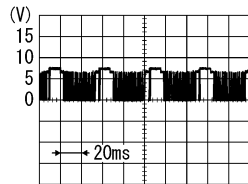

Are the voltage readings as specified?

YES >> GO TO 6

NO >> Replace satellite radio tuner.

## 6.CHECK RXD SIGNAL

Check signal between satellite radio tuner (factory installed) harness connector B123 terminal 30 and ground with CONSULT-III or oscilloscope.

## 30 - Ground

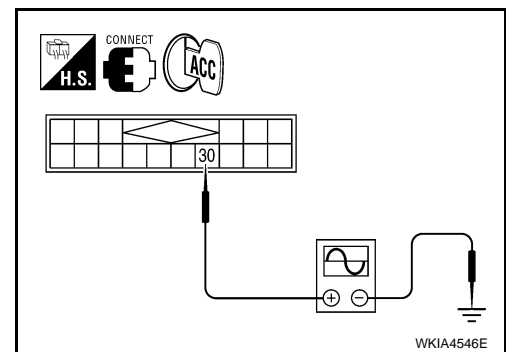
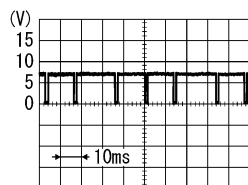

Are the voltage readings as specified?

YES >> Replace satellite radio tuner.

NO >> Replace audio unit. Refer to [AV-70, "Removal and Installation"](#).

A  
B  
C  
D  
E  
F  
G  
H  
I  
J  
K  
L  
M  
AV  
O  
P

# SOUND SIGNAL CIRCUIT (COUPE)

< COMPONENT DIAGNOSIS >

[BASE AUDIO]

## SOUND SIGNAL CIRCUIT (COUPE) SATELLITE RADIO TUNER

### SATELLITE RADIO TUNER : Description

INFOID:000000001830443

Left and right channel audio signals are supplied from the satellite radio tuner to the audio unit through the sound signal circuits.

### SATELLITE RADIO TUNER : Diagnosis Procedure

INFOID:000000001830444

#### LEFT CHANNEL

##### 1.CHECK HARNESS

1. Turn ignition switch OFF.
2. Disconnect satellite radio tuner (factory installed) connector B57 and audio unit connector M45.
3. Check continuity between satellite radio tuner (factory installed) connector B57 (A) and audio unit connector M45 (B).

A		B		Continuity
Connector	Terminal	Connector	Terminal	
B57	21	M45	31	Yes
	22		32	

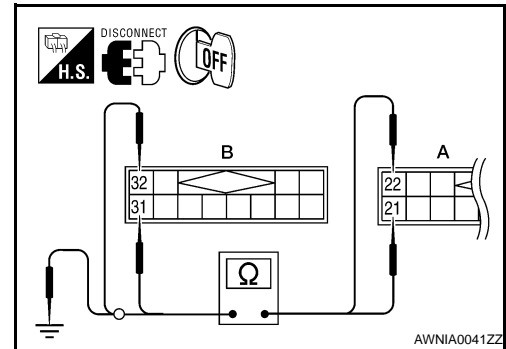

4. Check continuity between satellite radio tuner (factory installed) connector B57 (A) and ground.

A		—	Continuity
Connector	Terminal		
B57	21	Ground	No
	22		

Are continuity results as specified?

- YES >> GO TO 2  
NO >> Repair harness or connector.

##### 2.CHECK LEFT CHANNEL AUDIO SIGNAL

1. Connect satellite radio tuner (factory installed) and audio unit.
2. Turn ignition switch ON.
3. Check signal between satellite radio tuner (factory installed) connector B57 terminals 21 and 22 with CONSULT-III or oscilloscope.

21 - 22

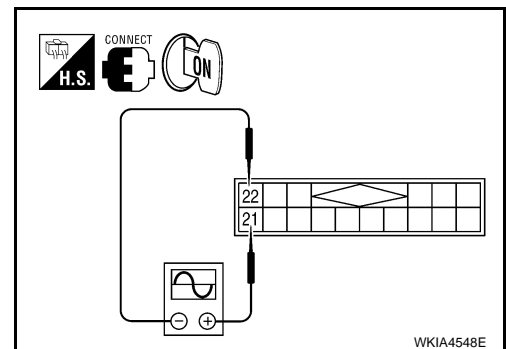
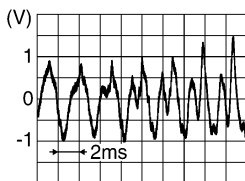

Are voltage readings as specified?

- YES >> Replace audio unit. Refer to [AV-70. "Removal and Installation"](#).  
NO >> Replace satellite radio tuner. Refer to [AV-214. "Removal and Installation - Coupe"](#).

#### RIGHT CHANNEL

##### 1.CHECK HARNESS

# SOUND SIGNAL CIRCUIT (COUPE)

[BASE AUDIO]

## < COMPONENT DIAGNOSIS >

1. Turn ignition switch OFF.
2. Disconnect satellite radio tuner (factory installed) connector B57 and audio unit connector M45.
3. Check continuity between satellite radio tuner (factory installed) connector B57 (A) and audio unit connector M45 (B).

A		B		Continuity
Connector	Terminal	Connector	Terminal	
B57	23	M45	33	Yes
	24		34	

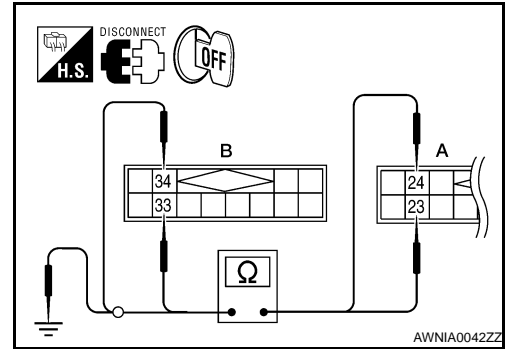

4. Check continuity between satellite radio tuner (factory installed) connector B57 (A) and ground.

A		—	Continuity
Connector	Terminal		
B57	23	Ground	No
	24		

Are continuity results as specified?

- YES >> GO TO 2  
 NO >> Repair harness or connector.

## 2. CHECK RIGHT CHANNEL AUDIO SIGNAL

1. Connect satellite radio tuner (factory installed) and audio unit.
2. Turn ignition switch ON.
3. Check signal between satellite radio tuner (factory installed) connector B57 terminals 23 and 24 with CONSULT-III or oscilloscope.

**23 - 24**

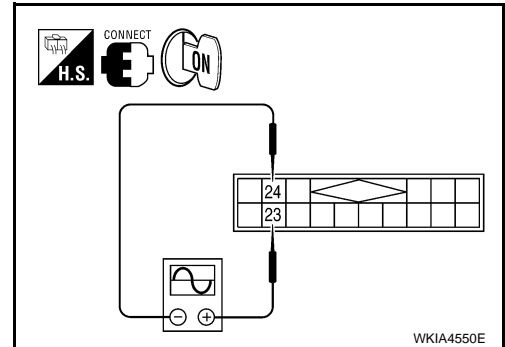
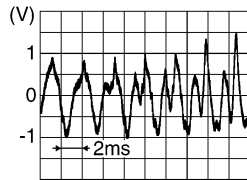

Are voltage readings as specified?

- YES >> Replace audio unit. Refer to [AV-70, "Removal and Installation"](#).  
 NO >> Replace satellite radio tuner. Refer to [AV-214, "Removal and Installation - Coupe"](#).

A  
B  
C  
D  
E  
F  
G  
H  
I  
J  
K  
L  
M

AV

# SOUND SIGNAL CIRCUIT (SEDAN)

< COMPONENT DIAGNOSIS >

[BASE AUDIO]

## SOUND SIGNAL CIRCUIT (SEDAN) SATELLITE RADIO TUNER

### SATELLITE RADIO TUNER : Description

INFOID:000000003221757

Left and right channel audio signals are supplied from the satellite radio tuner to the audio unit through the sound signal circuits.

### SATELLITE RADIO TUNER : Diagnosis Procedure

INFOID:000000003221759

#### LEFT CHANNEL

##### 1.CHECK HARNESS

1. Turn ignition switch OFF.
2. Disconnect satellite radio tuner (factory installed) connector B123 and audio unit connector M45.
3. Check continuity between satellite radio tuner (factory installed) connector B123 (A) and audio unit connector M45 (B).

A		B		Continuity
Connector	Terminal	Connector	Terminal	
B123	21	M45	31	Yes
	22		32	

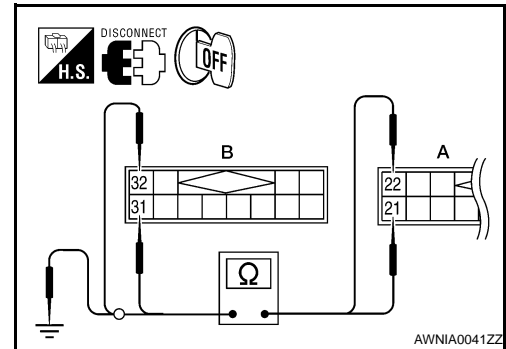

4. Check continuity between satellite radio tuner (factory installed) connector B123 (A) and ground.

A		—	Continuity
Connector	Terminal		
B123	21	Ground	No
	22		

Are continuity results as specified?

- YES >> GO TO 2  
NO >> Repair harness or connector.

##### 2.CHECK LEFT CHANNEL AUDIO SIGNAL

1. Connect satellite radio tuner (factory installed) and audio unit.
2. Turn ignition switch ON.
3. Check signal between satellite radio tuner (factory installed) connector B123 terminals 21 and 22 with CONSULT-III or oscilloscope.

21 - 22

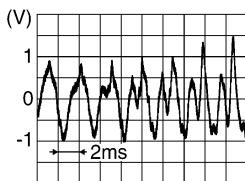

SKIB3609E

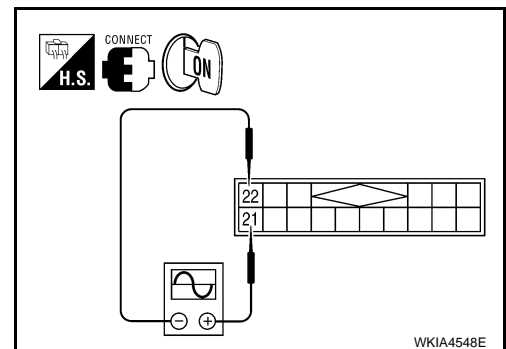

WKIA4548E

Are voltage readings as specified?

- YES >> Replace audio unit. Refer to [AV-70. "Removal and Installation"](#).  
NO >> Replace satellite radio tuner. Refer to [AV-214. "Removal and Installation - Sedan"](#).

#### RIGHT CHANNEL

##### 1.CHECK HARNESS

# SOUND SIGNAL CIRCUIT (SEDAN)

[BASE AUDIO]

## < COMPONENT DIAGNOSIS >

1. Turn ignition switch OFF.
2. Disconnect satellite radio tuner (factory installed) connector B123 and audio unit connector M45.
3. Check continuity between satellite radio tuner (factory installed) connector B123 (A) and audio unit connector M45 (B).

A		B		Continuity
Connector	Terminal	Connector	Terminal	
B123	23	M45	33	Yes
	24		34	

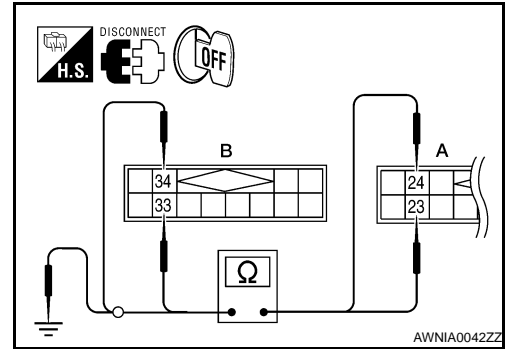

4. Check continuity between satellite radio tuner (factory installed) connector B123 (A) and ground.

A		—	Continuity
Connector	Terminal		
B123	23	Ground	No
	24		

Are continuity results as specified?

- YES >> GO TO 2  
 NO >> Repair harness or connector.

## 2. CHECK RIGHT CHANNEL AUDIO SIGNAL

1. Connect satellite radio tuner (factory installed) and audio unit.
2. Turn ignition switch ON.
3. Check signal between satellite radio tuner (factory installed) connector B123 terminals 23 and 24 with CONSULT-III or oscilloscope.

**23 - 24**

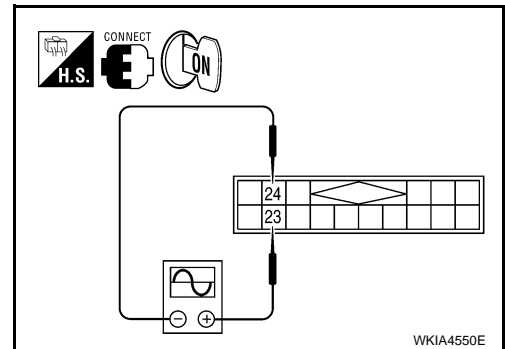
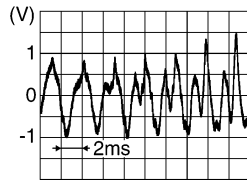

Are voltage readings as specified?

- YES >> Replace audio unit. Refer to [AV-70, "Removal and Installation"](#).  
 NO >> Replace satellite radio tuner. Refer to [AV-214, "Removal and Installation - Sedan"](#).

A  
B  
C  
D  
E  
F  
G  
H  
I  
J  
K  
L  
M

AV

# AUDIO UNIT (COUPE)

< ECU DIAGNOSIS >

[BASE AUDIO]

## ECU DIAGNOSIS

### AUDIO UNIT (COUPE)

Reference Value

INFOID:000000001830445

#### TERMINAL LAYOUT

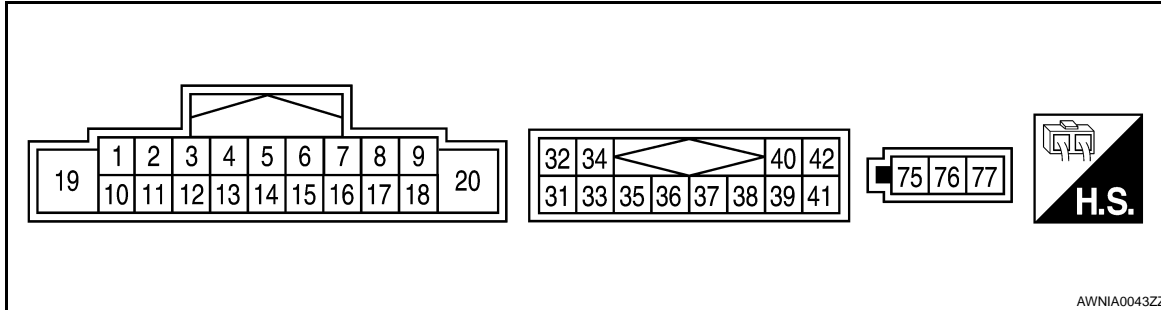

#### PHYSICAL VALUES

Terminal (Wire color)		Item	Signal input/output	Condition		Reference value
+	-			Ignition switch	Operation	
2 (W)	3 (B)	Audio sound signal front LH	Output	ON	Receive audio signal	<p>SKIA0177E</p>
4 (O/B)	5 (W/R)	Audio sound signal rear LH	Output	ON	Receive audio signal	<p>SKIA0177E</p>
6 (W/G)	Ground	Remote control A	Input	ON	Press SOURCE switch	Approx. 0.0V
					Press SEEK UP switch	Approx. 0.75V
					Press VOL UP switch	Approx. 2.0V
					Except for above	Approx. 5.0V
7 (V/Y)	Ground	ACC signal	Input	ON	Ignition switch ACC or ON	Battery voltage
9 (R/L)	8 (R/Y)	ILL signal	Input	ON	Headlamps ON	Battery voltage



# AUDIO UNIT (COUPE)

< ECU DIAGNOSIS >

[BASE AUDIO]

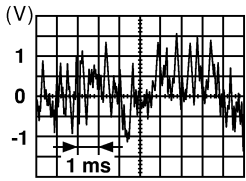
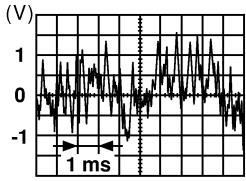
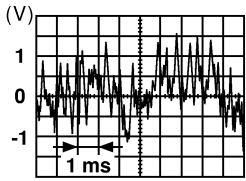
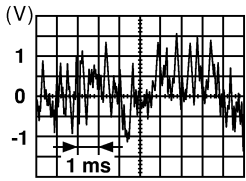
Terminal (Wire color)		Item	Signal in- put/out- put	Condition		Reference value
+	-			Ignition switch	Operation	
11 (G/W)	12 (BR)	Audio sound signal front RH	Output	ON	Receive audio sig- nal	 <small>SKIA0177E</small>
13 (L)	14 (B/W)	Audio sound signal rear RH	Output	ON	Receive audio sig- nal	 <small>SKIA0177E</small>
15 (L/B)	-	Remote con- trol ground	Input	-	-	-
16 (GR/L)	Ground	Remote con- trol B	Input	ON	Press SEEK DOWN switch	Approx. 0.75V
					Press VOL DOWN switch	Approx. 2.0V
					Except for above	Approx. 5.0V
19 (Y/R)	Ground	Battery power	Input	-	-	Battery voltage
32 (Y/L)	31 (W/L)	Audio left channel sound signal from satellite radio tuner	Input	ON	Receive audio sig- nal	 <small>SKIA0177E</small>
34 (BR/L)	33 (Y/G)	Audio right channel sound signal from satellite radio tuner	Input	ON	Receive audio sig- nal	 <small>SKIA0177E</small>
35	-	Shield ground (audio signal)	-	-	-	0V
36	-	Shield ground (data)	-	-	-	0V

A  
B  
C  
D  
E  
F  
G  
H  
I  
J  
K  
L  
M  
AV  
O  
P

# AUDIO UNIT (COUPE)

< ECU DIAGNOSIS >

[BASE AUDIO]

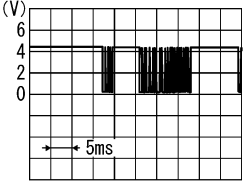
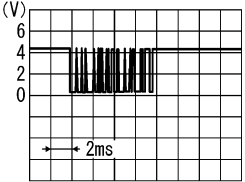
Terminal (Wire color)		Item	Signal in- put/out- put	Condition		Reference value
+	-			Ignition switch	Operation	
38 (R)	Ground	Satellite radio tuner request to audio unit	Input	ON	Turn audio unit ON	5V
39 (G)	Ground	Audio RX	Input		Operate audio vol- ume	
40 (B)	Ground	Audio TX	Output		Operate audio vol- ume	
75 (B)	Ground	Antenna amp power supply	Output	ON	Turn audio unit ON	Battery voltage
76 (B)	Ground	Main antenna	Input	ON	Turn audio unit ON	-

# AUDIO UNIT (COUPE)

< ECU DIAGNOSIS >

[BASE AUDIO]

## Wiring Diagram — Coupe

INFOID:000000001830446

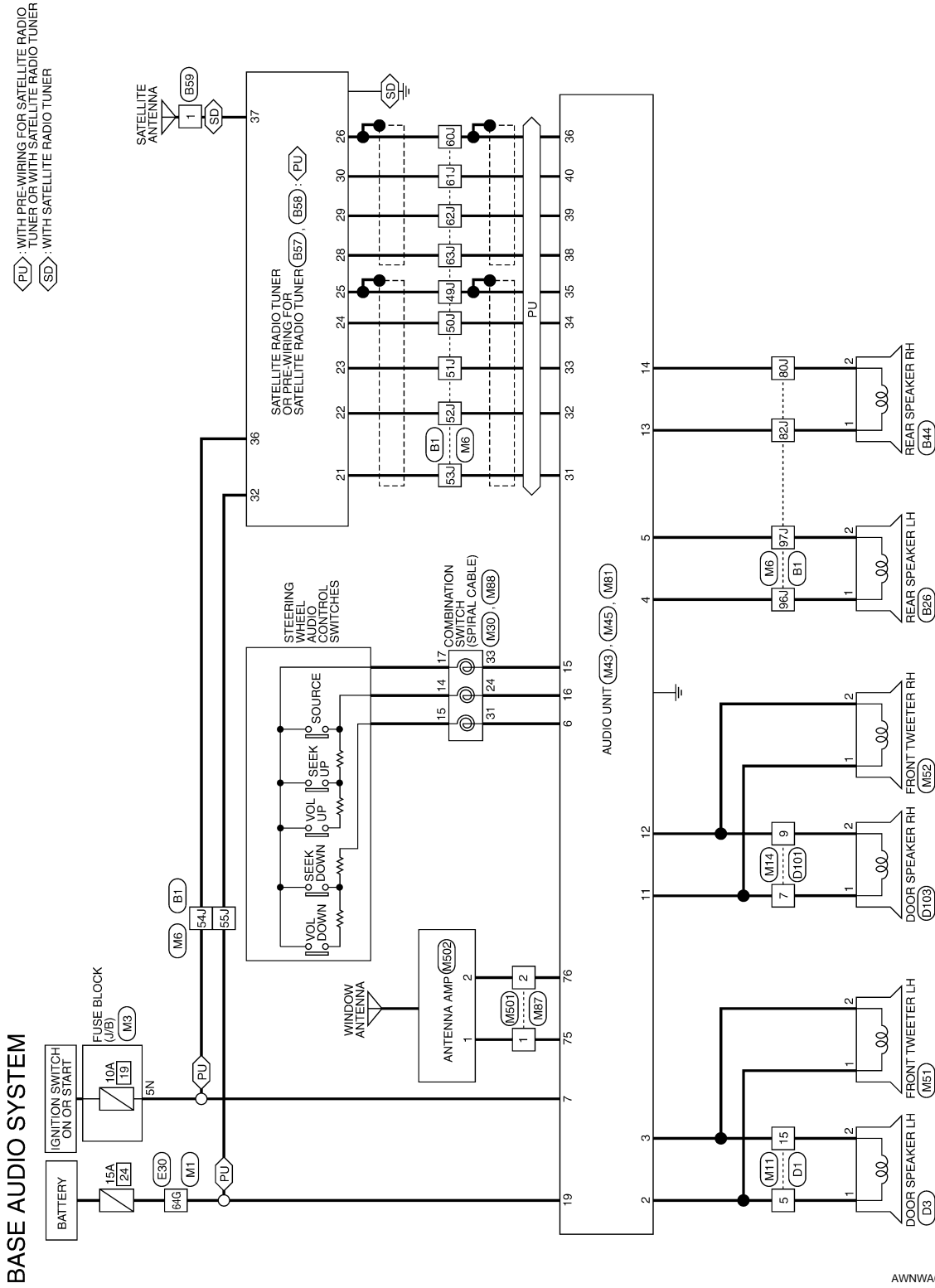

AWNWA0018G

A  
B  
C  
D  
E  
F  
G  
H  
I  
J  
K  
L  
M  
N  
O  
P

AV



# AUDIO UNIT (COUPE)

< ECU DIAGNOSIS >

[BASE AUDIO]

Connector No.	M30
Connector Name	COMBINATION SWITCH (SPIRAL CABLE)
Connector Color	GRAY

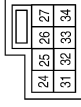

Terminal No.	Color of Wire	Signal Name
24	W/G	AUDIO_STRG_SW_REMOTE_A
31	GR/L	AUDIO_STRG_SW_REMOTE_B
33	L/B	AUDIO_STRG_SW_GND

Connector No.	M14
Connector Name	WIRE TO WIRE
Connector Color	WHITE

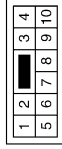

Terminal No.	Color of Wire	Signal Name
7	G/W	-
9	BR	-

Connector No.	M11
Connector Name	WIRE TO WIRE
Connector Color	WHITE



Terminal No.	Color of Wire	Signal Name
5	W	-
15	B	-

Connector No.	M45
Connector Name	AUDIO UNIT
Connector Color	WHITE



Terminal No.	Color of Wire	Signal Name
31	W/L	SAT LH INPUT (-)
32	Y/L	SAT LH INPUT (+)
33	Y/G	SAT RH INPUT (-)
34	BR/L	SAT RH INPUT (+)
35	SHIELD	EARTH
36	SHIELD	DAT EARTH
37	-	-
38	R	RFQ1 (SAT TO COMBI)
39	G	RX (SAT TO COMBI)
40	B	TX (COMBI TO SAT)
41	-	-
42	-	-

Terminal No.	Color of Wire	Signal Name
6	W/G	STRG_SW_A
7	V/Y	ACC
8	R/Y	ILL_CONT_OUT
9	R/L	TAIL/ILL_RLY
10	-	-
11	G/W	FR SP RH (+)
12	BR	FR SP RH (-)
13	L	RR SP RH (+)
14	B/W	RR SP RH (-)
15	L/B	STRG_SW_GND
16	GR/L	STRG_SW_B
17	-	-
18	-	-
19	Y/R	BAT
20	-	-

Connector No.	M43
Connector Name	AUDIO UNIT
Connector Color	WHITE

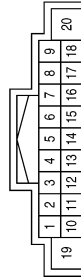

Terminal No.	Color of Wire	Signal Name
1	-	-
2	W	FR SP LH (+)
3	B	FR SP LH (-)
4	O/B	RR SP LH (+)
5	W/R	RR SP LH (-)

ALNIA0028GB

A  
B  
C  
D  
E  
F  
G  
H  
I  
J  
K  
L  
M  
O  
P

AV

# AUDIO UNIT (COUPE)

< ECU DIAGNOSIS >

[BASE AUDIO]

Connector No.	M52
Connector Name	FRONT TWEETER RH
Connector Color	BROWN



Terminal No.	Color of Wire	Signal Name
1	G/W	-
2	BR	-

Connector No.	M81
Connector Name	AUDIO UNIT
Connector Color	GRAY



Terminal No.	Color of Wire	Signal Name
75	B	AMP POWER SUPPLY
76	B	MAIN ANTENNA
77	-	-

Connector No.	M87
Connector Name	WIRE TO WIRE
Connector Color	GRAY

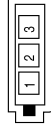

Terminal No.	Color of Wire	Signal Name
1	B	-
2	B	-

Connector No.	M88
Connector Name	COMBINATION SWITCH (SPIRAL CABLE)
Connector Color	GRAY

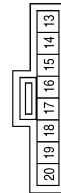

Terminal No.	Color of Wire	Signal Name
14	W	REMOTE A
15	L	REMOTE B
17	BR	GND

Connector No.	M501
Connector Name	WIRE TO WIRE
Connector Color	GRAY



Terminal No.	Color of Wire	Signal Name
1	B	-
2	B	-

Connector No.	M502
Connector Name	ANTENNA AMP
Connector Color	GRAY



Terminal No.	Color of Wire	Signal Name
1	B	-
2	B	-

AWNIA0353GB

# AUDIO UNIT (COUPE)

< ECU DIAGNOSIS >

[BASE AUDIO]

Terminal No.	Color of Wire	Signal Name
49J	SHIELD	-
50J	BR/L	-
51J	Y/G	-
52J	Y/L	-
53J	W/L	-
54J	V/Y	-
55J	Y/R	-
60J	SHIELD	-
61J	B	-
62J	G	-
63J	R	-
80J	B/W	-
82J	L	-
96J	O/B	-
97J	W/R	-

Connector No.	B1
Connector Name	WIRE TO WIRE
Connector Color	WHITE

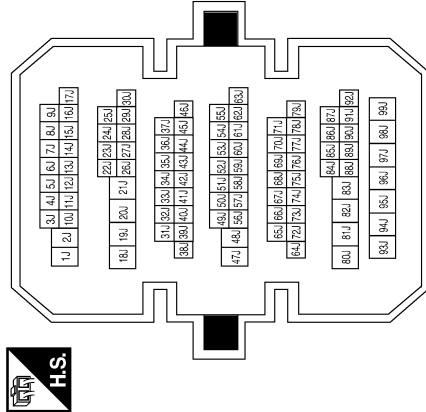

Connector No.	E30
Connector Name	WIRE TO WIRE
Connector Color	WHITE

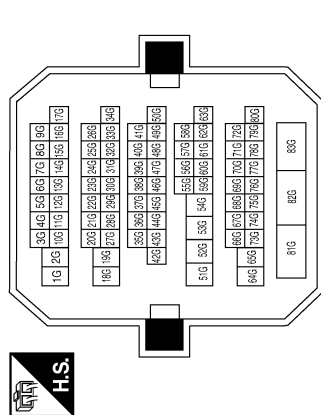

Terminal No.	Color of Wire	Signal Name
64G	Y/R	-

Connector No.	B44
Connector Name	REAR SPEAKER RH
Connector Color	WHITE

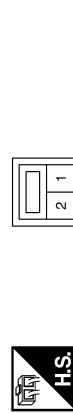

Terminal No.	Color of Wire	Signal Name
1	L	-
2	B/W	-

Connector No.	B26
Connector Name	REAR SPEAKER LH
Connector Color	WHITE

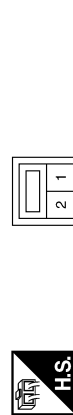

Terminal No.	Color of Wire	Signal Name
1	O/B	-
2	W/R	-

AWNIA0330GB

A  
B  
C  
D  
E  
F  
G  
H  
I  
J  
K  
L  
M  
N  
O  
P

AV

# AUDIO UNIT (COUPE)

< ECU DIAGNOSIS >

[BASE AUDIO]

Connector No.	B58
Connector Name	SATELLITE RADIO TUNER OR PRE-WIRING FOR SATELLITE RADIO TUNER
Connector Color	BROWN (WITH SIRIUS SATELLITE RADIO) VIOLET (WITH XM SATELLITE RADIO)



Terminal No.	Color of Wire	Signal Name
37	B	ANTENNA SIGNAL

Terminal No.	Color of Wire	Signal Name
21	W/L	SAT_LCH (-)
22	Y/L	SAT_LCH (+)
23	Y/G	SAT_RCH (-)
24	BR/L	SAT_RCH (+)
25	SHIELD	EARTH (SIG)
26	SHIELD	DATA
27	-	-
28	R/L	EC1 (SAT-COMBI)
29	R/W	TXD (SAT_COMBI)
30	B	RXD (COMBI_SAT)
31	-	-
32	Y/R	BAT
33	-	-
34	-	-
35	-	-
36	GR/W	ACC

Connector No.	B57
Connector Name	SATELLITE RADIO TUNER OR PRE-WIRING FOR SATELLITE RADIO TUNER
Connector Color	WHITE



Connector No.	D3
Connector Name	DOOR SPEAKER LH
Connector Color	WHITE



Terminal No.	Color of Wire	Signal Name
1	W	-
2	B	-

Connector No.	D1
Connector Name	WIRE TO WIRE
Connector Color	WHITE

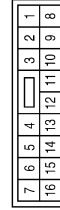

Terminal No.	Color of Wire	Signal Name
5	W	-
15	B	-

Connector No.	B59
Connector Name	SATELLITE RADIO ANTENNA
Connector Color	GRAY (WITH SIRIUS SATELLITE RADIO) BROWN (WITH XM SATELLITE RADIO)



Terminal No.	Color of Wire	Signal Name
1	B	-

AWNIA0331GB



# AUDIO UNIT (COUPE)

< ECU DIAGNOSIS >

[BASE AUDIO]

A  
B  
C  
D  
E  
F  
G  
H  
I  
J  
K  
L  
M  
AV  
O  
P

Connector No.	D103
Connector Name	DOOR SPEAKER RH
Connector Color	BROWN



Terminal No.	Color of Wire	Signal Name
1	G/W	-
2	BR	-

Connector No.	D101
Connector Name	WIRE TO WIRE
Connector Color	WHITE

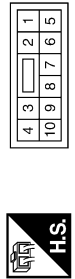

Terminal No.	Color of Wire	Signal Name
7	G/W	-
9	BR	-

AWNIA0354GB

# AUDIO UNIT (SEDAN)

< ECU DIAGNOSIS >

[BASE AUDIO]

## AUDIO UNIT (SEDAN)

Reference Value

INFOID:000000003229330

### TERMINAL LAYOUT

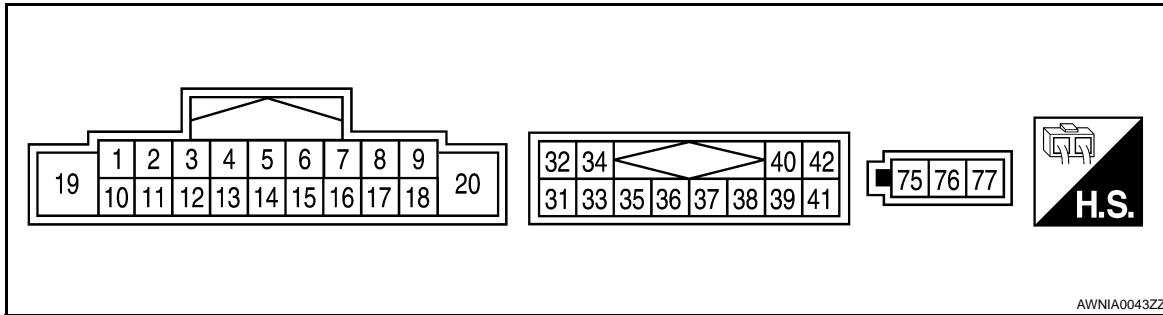

### PHYSICAL VALUES

Terminal (Wire color)		Item	Signal in- put/out- put	Condition		Reference value
+	-			Ignition switch	Operation	
2 (W)	3 (B)	Audio sound signal front LH	Output	ON	Receive audio sig- nal	<p style="text-align: right; font-size: small;">SKIA0177E</p>
4 (O/B)	5 (W/R)	Audio sound signal rear LH	Output	ON	Receive audio sig- nal	<p style="text-align: right; font-size: small;">SKIA0177E</p>
6 (W/G)	Ground	Remote con- trol A	Input	ON	Press SOURCE switch	Approx. 0.0V
					Press SEEK UP switch	Approx. 0.75V
					Press VOL UP switch	Approx. 2.0V
					Except for above	Approx. 5.0V
7 (V/Y)	Ground	ACC signal	Input	ON	Ignition switch ACC or ON	Battery voltage
9 (R/L)	8 (R/Y)	ILL signal	Input	ON	Headlamps ON	Battery voltage
11 (G/W)	12 (BR)	Audio sound signal front RH	Output	ON	Receive audio sig- nal	<p style="text-align: right; font-size: small;">SKIA0177E</p>

# AUDIO UNIT (SEDAN)

< ECU DIAGNOSIS >

[BASE AUDIO]

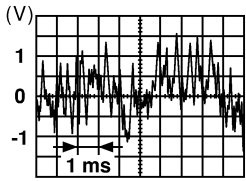
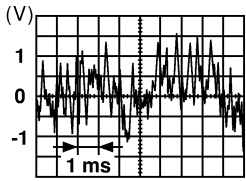
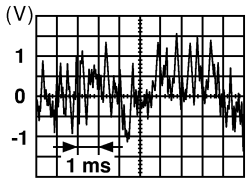
Terminal (Wire color)		Item	Signal in- put/out- put	Condition		Reference value
+	-			Ignition switch	Operation	
13 (L)	14 (B/W)	Audio sound signal rear RH	Output	ON	Receive audio sig- nal	
15 (L/B)	-	Remote con- trol ground	Input	-	-	-
16 (GR/L)	Ground	Remote con- trol B	Input	ON	Press SEEK DOWN switch	Approx. 0.75V
					Press VOL DOWN switch	Approx. 2.0V
					Except for above	Approx. 5.0V
19 (Y/R)	Ground	Battery power	Input	-	-	Battery voltage
32 (Y/L)	31 (W/L)	Audio left channel sound signal from satellite radio tuner	Input	ON	Receive audio sig- nal	
34 (BR/L)	33 (Y/G)	Audio right channel sound signal from satellite radio tuner	Input	ON	Receive audio sig- nal	
35	-	Shield ground (audio signal)	-	-	-	0V
36	-	Shield ground (data)	-	-	-	0V

A  
B  
C  
D  
E  
F  
G  
H  
I  
J  
K  
L  
M

AV

# AUDIO UNIT (SEDAN)

< ECU DIAGNOSIS >

[BASE AUDIO]

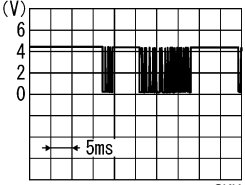
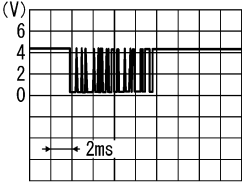
Terminal (Wire color)		Item	Signal in- put/out- put	Condition		Reference value
+	-			Ignition switch	Operation	
38 (R)	Ground	Satellite radio tuner request to audio unit	Input	ON	Turn audio unit ON	5V
39 (G)	Ground	Audio RX	Input		Operate audio vol- ume	 <small>SKIA4403E</small>
40 (B)	Ground	Audio TX	Output		Operate audio vol- ume	 <small>SKIA4402E</small>
75 (B)	Ground	Antenna amp power supply	Output	ON	Turn audio unit ON	Battery voltage
76 (B)	Ground	Main antenna	Input	ON	Turn audio unit ON	-

# AUDIO UNIT (SEDAN)

< ECU DIAGNOSIS >

[BASE AUDIO]

## Wiring Diagram — Sedan

INFOID:000000003221764

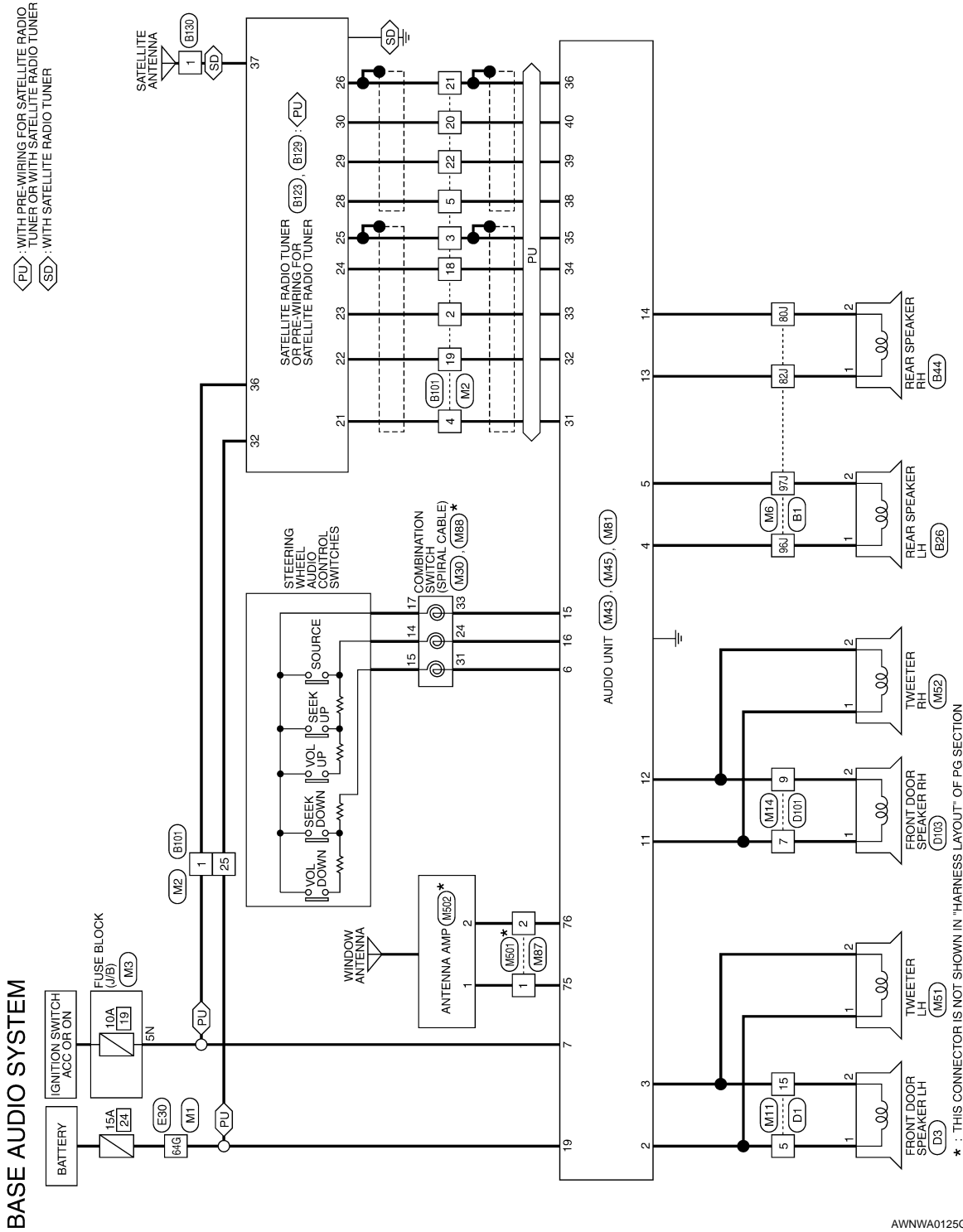

AWNWA0125G

A  
B  
C  
D  
E  
F  
G  
H  
I  
J  
K  
L  
M  
O  
P

AV

## BASE AUDIO CONNECTORS

Connector No.	M1
Connector Name	WIRE TO WIRE
Connector Color	WHITE

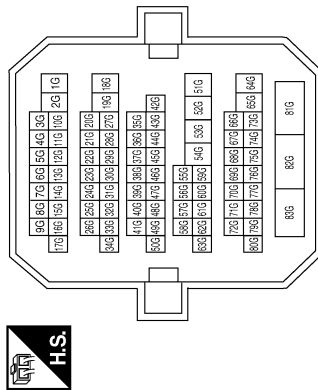

Terminal No.	64G	Color of Wire	Y/R	Signal Name	-
--------------	-----	---------------	-----	-------------	---

Connector No.	M3
Connector Name	FUSE BLOCK (J/B)
Connector Color	WHITE

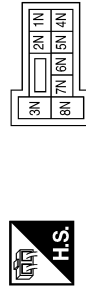

Terminal No.	5N	Color of Wire	V/Y	Signal Name	-
--------------	----	---------------	-----	-------------	---

Connector No.	M2
Connector Name	WIRE TO WIRE
Connector Color	WHITE

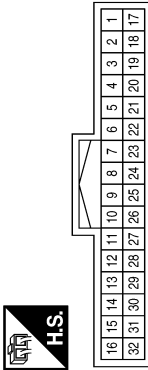

Terminal No.	1	Color of Wire	V/Y	Signal Name	-
Terminal No.	2	Color of Wire	Y/G	Signal Name	-
Terminal No.	3	Color of Wire	SHIELD	Signal Name	-
Terminal No.	4	Color of Wire	W/L	Signal Name	-
Terminal No.	5	Color of Wire	R	Signal Name	-
Terminal No.	18	Color of Wire	BR/L	Signal Name	-
Terminal No.	19	Color of Wire	Y/L	Signal Name	-
Terminal No.	20	Color of Wire	B	Signal Name	-
Terminal No.	21	Color of Wire	SHIELD	Signal Name	-
Terminal No.	22	Color of Wire	G	Signal Name	-
Terminal No.	25	Color of Wire	Y/R	Signal Name	-

Connector No.	M6
Connector Name	WIRE TO WIRE
Connector Color	WHITE

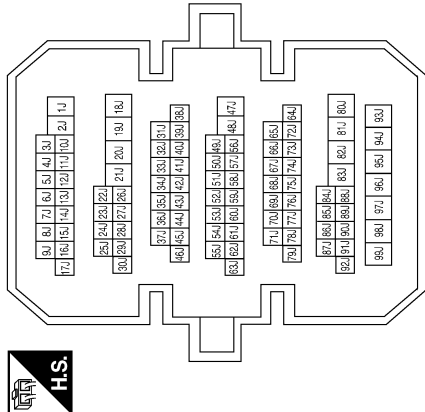

Terminal No.	80J	Color of Wire	B/W	Signal Name	-
Terminal No.	82J	Color of Wire	L	Signal Name	-
Terminal No.	96J	Color of Wire	O/B	Signal Name	-
Terminal No.	97J	Color of Wire	W/R	Signal Name	-

# AUDIO UNIT (SEDAN)

< ECU DIAGNOSIS >

[BASE AUDIO]

Connector No.	M30
Connector Name	COMBINATION SWITCH (SPIRAL CABLE)
Connector Color	GRAY

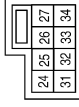

Terminal No.	Color of Wire	Signal Name
24	W/G	AUDIO_STRG_SW_REMOTE_A
31	GR/L	AUDIO_STRG_SW_REMOTE_B
33	L/B	AUDIO_STRG_SW_GND

Connector No.	M14
Connector Name	WIRE TO WIRE
Connector Color	WHITE

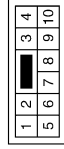

Terminal No.	Color of Wire	Signal Name
7	G/W	-
9	BR	-

Connector No.	M11
Connector Name	WIRE TO WIRE
Connector Color	WHITE



Terminal No.	Color of Wire	Signal Name
5	W	-
15	B	-

Connector No.	M45
Connector Name	AUDIO UNIT
Connector Color	WHITE



Terminal No.	Color of Wire	Signal Name
31	W/L	SAT LH INPUT (-)
32	Y/L	SAT LH INPUT (+)
33	Y/G	SAT RH INPUT (-)
34	BR/L	SAT RH INPUT (+)
35	SHIELD	EARTH
36	SHIELD	DAT EARTH
37	-	-
38	R	RFQ1 (SAT TO COMBI)
39	G	RX (SAT TO COMBI)
40	B	TX (COMBI TO SAT)
41	-	-
42	-	-

Terminal No.	Color of Wire	Signal Name
6	W/G	STRG_SW_A
7	V/Y	ACC
8	R/Y	ILL_CONT_OUT
9	R/L	TAIL/ILL_RLY
10	-	-
11	G/W	FR SP RH (+)
12	BR	FR SP RH (-)
13	L	RR SP RH (+)
14	B/W	RR SP RH (-)
15	L/B	STRG_SW_GND
16	GR/L	STRG_SW_B
17	-	-
18	-	-
19	Y/R	BAT
20	-	-

Connector No.	M43
Connector Name	AUDIO UNIT
Connector Color	WHITE

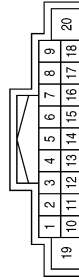

Terminal No.	Color of Wire	Signal Name
1	-	-
2	W	FR SP LH (+)
3	B	FR SP LH (-)
4	O/B	RR SP LH (+)
5	W/R	RR SP LH (-)

ALNIA0028GB

A  
B  
C  
D  
E  
F  
G  
H  
I  
J  
K  
L  
M  
N  
O  
P

AV

# AUDIO UNIT (SEDAN)

< ECU DIAGNOSIS >

[BASE AUDIO]

Connector No.	M81
Connector Name	AUDIO UNIT
Connector Color	GRAY

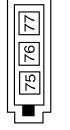

Terminal No.	Color of Wire	Signal Name
75	B	AMP POWER SUPPLY
76	B	MAIN ANTENNA
77	-	-

Connector No.	M52
Connector Name	TWEETER RH
Connector Color	BROWN



Terminal No.	Color of Wire	Signal Name
1	G/W	-
2	BR	-

Connector No.	M51
Connector Name	TWEETER LH
Connector Color	BROWN



Terminal No.	Color of Wire	Signal Name
1	W	-
2	B	-

Connector No.	M501
Connector Name	WIRE TO WIRE
Connector Color	GRAY

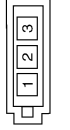

Terminal No.	Color of Wire	Signal Name
1	B	-
2	B	-

Connector No.	M88
Connector Name	COMBINATION SWITCH (SPIRAL CABLE)
Connector Color	GRAY

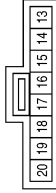

Terminal No.	Color of Wire	Signal Name
14	W	REMOTE A
15	L	REMOTE B
17	BR	GND

Connector No.	M87
Connector Name	WIRE TO WIRE
Connector Color	GRAY

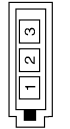

Terminal No.	Color of Wire	Signal Name
1	B	-
2	B	-

Connector No.	M502
Connector Name	ANTENNA AMP
Connector Color	GRAY

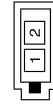

Terminal No.	Color of Wire	Signal Name
1	B	-
2	B	-

ALNIA0029GB



# AUDIO UNIT (SEDAN)

< ECU DIAGNOSIS >

[BASE AUDIO]

Terminal No.	Color of Wire	Signal Name
80J	B/W	-
82J	L	-
96J	O/B	-
97J	W/R	-

Connector No.	B1
Connector Name	WIRE TO WIRE
Connector Color	WHITE

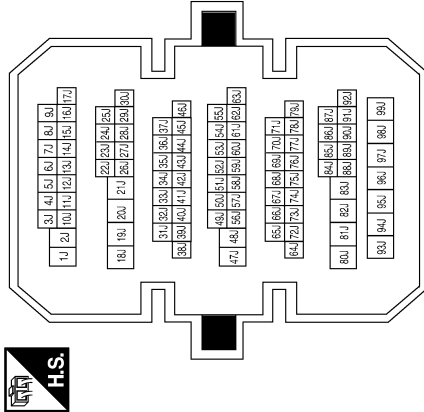

Connector No.	E30
Connector Name	WIRE TO WIRE
Connector Color	WHITE

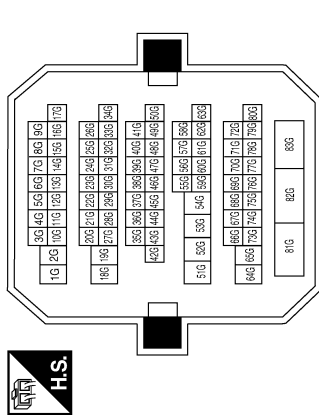

Terminal No.	Color of Wire	Signal Name
64G	Y/R	-

Connector No.	B44
Connector Name	REAR SPEAKER RH
Connector Color	WHITE

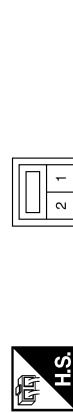

Terminal No.	Color of Wire	Signal Name
1	L	-
2	B/W	-

Connector No.	B26
Connector Name	REAR SPEAKER LH
Connector Color	WHITE

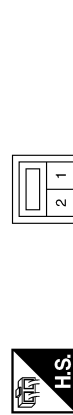

Terminal No.	Color of Wire	Signal Name
1	O/B	-
2	W/R	-

ALNIA0075GB

A  
B  
C  
D  
E  
F  
G  
H  
I  
J  
K  
L  
M  
N  
O  
P

AV

# AUDIO UNIT (SEDAN)

< ECU DIAGNOSIS >

[BASE AUDIO]

Connector No.	M41
Connector Name	SATELLITE RADIO TUNER OR PRE-WIRING FOR SATELLITE RADIO TUNER
Connector Color	WHITE

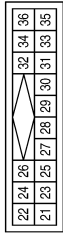

Terminal No.	Color of Wire	Signal Name
21	G	SAT_LCH (-)
22	R	SAT_LCH (+)
23	W	SAT_RCH (-)
24	B	SAT_RCH (+)

Terminal No.	Color of Wire	Signal Name
25	SHIELD	EARTH
26	SHIELD	DATA_EARTH
27	-	-
28	O	REQ (TO_HU)
29	L	RX (TO_HU)
30	P	TX (FROM_HU)
31	-	-
32	R/B	BACKUP
33	-	-
34	-	-
35	-	-
36	G/B	ACC

Connector No.	M42
Connector Name	AV CONTROL UNIT
Connector Color	WHITE

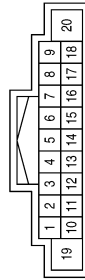

Terminal No.	Color of Wire	Signal Name
1	SB	AMP ON
2	R	FR_LH_PRE+
3	B	FR_LH_PRE-
4	L	FR_LH_PRE+
5	Y	FR_LH_PRE-
6	Y	STRG_SW_A
7	G/Y	ACC
8	-	-

Terminal No.	Color of Wire	Signal Name
9	V	ILL
10	SHIELD	SHIELD
11	G	FR_RH_PRE+
12	W	FR_RH_PRE-
13	R	RR_RH_PRE+
14	B	RR_RH_PRE-
15	SHIELD	STRG_SW_GND
16	BR	STRG_SW_B
17	-	-
18	-	-
19	Y	+B
20	B	GND

Connector No.	M43
Connector Name	AV CONTROL UNIT
Connector Color	WHITE



Terminal No.	Color of Wire	Signal Name
21	L	R
22	G	G
23	Y	B
24	-	RGB_GND
25	R	RGB_SYNC
26	-	RGB_SYNC_GND
27	G	YS
28	B	HP
29	W	VP
30	V	IT_DISP
31	LG	DISP_IT
32	-	SHIELD

ALNIA0608GB

# AUDIO UNIT (SEDAN)

< ECU DIAGNOSIS >

[BASE AUDIO]

Connector No.	D103
Connector Name	FRONT DOOR SPEAKER RH
Connector Color	BROWN



Terminal No.	Color of Wire	Signal Name
1	G/W	-
2	BR	-

Connector No.	D101
Connector Name	WIRE TO WIRE
Connector Color	WHITE

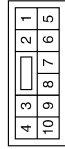

Terminal No.	Color of Wire	Signal Name
7	G/W	-
9	BR	-

Connector No.	D3
Connector Name	FRONT DOOR SPEAKER LH
Connector Color	WHITE



Terminal No.	Color of Wire	Signal Name
1	W	-
2	B	-

A  
B  
C  
D  
E  
F  
G  
H  
I  
J  
K  
L  
M  
AV  
O  
P

ALNIA0077GB

# SATELLITE RADIO TUNER

< ECU DIAGNOSIS >

[BASE AUDIO]

## SATELLITE RADIO TUNER

Reference Value

INFOID:000000001830447

### TERMINAL LAYOUT

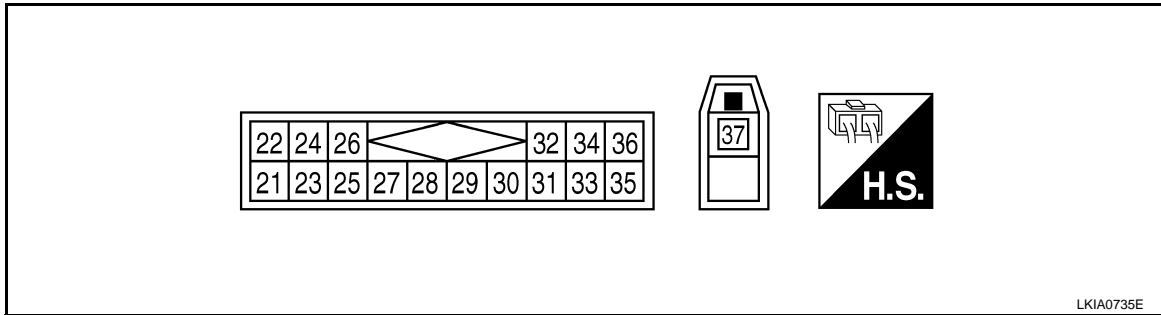

### PHYSICAL VALUES

Terminal (Wire color)		Item	Signal input/ output	Condition		Voltage (approx.)
+	-			Ignition switch	Operation	
22 (Y/L)	21 (W/L)	Audio signal LH	Output	ON	Receive audio signal.	<p>SKIB3609E</p>
24 (BR/L)	23 (Y/G)	Audio signal RH	Output	ON	Receive audio signal.	<p>SKIB3609E</p>
25	-	Shield	-	-	-	-
26	-	Data ground	-	ON	-	Approx. 0 V
28 (R/L)	Ground	REQ1 (SAT-AUDIO)	Output	ON	Set to the satellite radio mode	<p>SKIB3825E</p>
29 (R/W)	Ground	Communication signal (SAT-AUDIO)	Output	ON	Set to the satellite radio mode	<p>SKIB3824E</p>

# SATELLITE RADIO TUNER

< ECU DIAGNOSIS >

[BASE AUDIO]

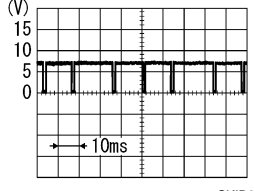
Terminal (Wire color)		Item	Signal input/ output	Condition		Voltage (approx.)
+	-			Ignition switch	Operation	
30 (B)	Ground	Communication signal (AUDIO-SAT)	Input	ON	Set to the satellite radio mode	
32 (Y/R)	Ground	Battery power supply	Input	OFF	-	Battery voltage
36 (GR/W)		ACC power supply		ACC		
37 (B)	-	Antenna signal		-		

A  
B  
C  
D  
E  
F  
G  
H  
I  
J  
K  
L  
M

AV

O  
P

## SYMPTOM DIAGNOSIS

### AUDIO SYSTEM

#### AUDIO UNIT

#### AUDIO UNIT : Symptom Table

INFOID:000000001830449

Symptom	Possible cause	Reference page
Inoperative	<ul style="list-style-type: none"> <li>• Audio unit power circuit</li> <li>• Audio unit</li> </ul>	<ul style="list-style-type: none"> <li>• <a href="#">AV-20</a></li> <li>• <a href="#">AV-70</a></li> </ul>
Steering wheel audio control switch does not operate	<ul style="list-style-type: none"> <li>• Steering wheel audio control switch</li> <li>• Audio unit</li> </ul>	<ul style="list-style-type: none"> <li>• <a href="#">AV-34</a></li> <li>• <a href="#">AV-70</a></li> </ul>
All speakers do not sound	<ul style="list-style-type: none"> <li>• Audio unit power circuit</li> <li>• Audio unit</li> </ul>	<ul style="list-style-type: none"> <li>• <a href="#">AV-20</a></li> <li>• <a href="#">AV-70</a></li> </ul>
One or several speakers do not sound	<ul style="list-style-type: none"> <li>• Door speaker</li> <li>• Front tweeter</li> <li>• Rear speaker</li> </ul>	<ul style="list-style-type: none"> <li>• <a href="#">AV-24</a></li> <li>• <a href="#">AV-28</a></li> <li>• <a href="#">AV-32</a></li> </ul>

### CD

#### CD : Symptom Table

INFOID:000000001830450

Symptom	Possible cause	Reference page
CD cannot be inserted.	Audio unit	<a href="#">AV-70</a>
CD cannot be ejected.		
The CD cannot be played.		
The sound skips, stops suddenly, or is distorted.		

### SATELLITE RADIO TUNER

#### SATELLITE RADIO TUNER : Symptom Table

INFOID:000000001830451

Symptom	Possible cause	Reference page
Inoperative	<ul style="list-style-type: none"> <li>• Satellite radio tuner power or ground circuit</li> <li>• Satellite radio tuner communication circuit</li> <li>• Satellite radio tuner</li> </ul>	<ul style="list-style-type: none"> <li>• <a href="#">AV-20</a></li> <li>• <a href="#">AV-36</a></li> <li>• <a href="#">AV-214</a></li> </ul>
Right or left channel does not sound	<ul style="list-style-type: none"> <li>• Satellite radio tuner right channel audio signal circuit</li> <li>• Satellite radio tuner left channel audio signal circuit</li> <li>• Satellite radio tuner</li> </ul>	<ul style="list-style-type: none"> <li>• <a href="#">AV-40</a></li> <li>• <a href="#">AV-40</a></li> <li>• <a href="#">AV-214</a></li> </ul>

# NORMAL OPERATING CONDITION

< SYMPTOM DIAGNOSIS >

[BASE AUDIO]

## NORMAL OPERATING CONDITION

### Description

INFOID:000000001830452

The majority of the audio concerns are the result of outside causes (bad CD, electromagnetic interference, etc.).

### NOISE

The following noise results from variations in field strength, such as fading noise and multi-path noise, or external noise from trains and other sources. It is not a malfunction.

- Fading noise: This noise occurs because of variations in the field strength in a narrow range due to mountains or buildings blocking the signal.
- Multi-path noise: This noise results from the waves sent directly from the broadcast station arriving at the antenna at a different time from the waves which reflect off mountains or buildings.

The vehicle itself can be a source of noise if noise prevention parts or electrical equipment is malfunctioning. Check if noise is caused and/or changed by engine speed, ignition switch turned to each position, and operation of each piece of electrical equipment, and determine the cause.

### NOTE:

The source of the noise can be found easily by listening to the noise while removing the fuses of electrical components, one by one.

### Type of Noise and Possible Cause

Occurrence condition		Possible cause
Occurs only when engine is ON.	A continuous growling noise occurs. The speed of the noise varies with changes in the engine speed.	• Ignition components
The occurrence of the noise is linked with the operation of the fuel pump.		• Fuel pump condenser
Noise only occurs when various electrical components are operating.	A cracking or snapping sound occurs with the operation of various switches.	• Relay malfunction, audio unit malfunction
	The noise occurs when various motors are operating.	• Motor case ground • Motor
The noise occurs constantly, not just under certain conditions.		• Rear defogger coil malfunction • Open circuit in printed heater • Poor ground of antenna feeder line
A cracking or snapping sound occurs while the vehicle is being driven, especially when it is vibrating excessively.		• Ground wire of body parts • Ground due to improper part installation • Wiring connections or a short circuit

A  
B  
C  
D  
E  
F  
G  
H  
I  
J  
K  
L  
M  
O  
P

AV

## PRECAUTION

### PRECAUTIONS

#### Supplemental Restraint System (SRS) "AIR BAG" and "SEAT BELT PRE-TENSIONER"

INFOID:000000001345951

The Supplemental Restraint System such as "AIR BAG" and "SEAT BELT PRE-TENSIONER", used along with a front seat belt, helps to reduce the risk or severity of injury to the driver and front passenger for certain types of collision. This system includes seat belt switch inputs and dual stage front air bag modules. The SRS system uses the seat belt switches to determine the front air bag deployment, and may only deploy one front air bag, depending on the severity of a collision and whether the front occupants are belted or unbelted. Information necessary to service the system safely is included in the SR and SB section of this Service Manual.

**WARNING:**

- To avoid rendering the SRS inoperative, which could increase the risk of personal injury or death in the event of a collision which would result in air bag inflation, all maintenance must be performed by an authorized NISSAN/INFINITI dealer.
- Improper maintenance, including incorrect removal and installation of the SRS, can lead to personal injury caused by unintentional activation of the system. For removal of Spiral Cable and Air Bag Module, see the SR section.
- Do not use electrical test equipment on any circuit related to the SRS unless instructed to in this Service Manual. SRS wiring harnesses can be identified by yellow and/or orange harnesses or harness connectors.



PREPARATION

PREPARATION

Commercial Service Tools

INFOID:000000001345952

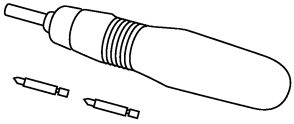
Tool name	Description
<p>Power tool</p>  <p>PBIC0191E</p>	<p>Loosening bolts and nuts</p>

A  
B  
C  
D  
E  
F  
G  
H  
I  
J  
K  
L  
M  
N  
O  
P

AV

**ON-VEHICLE REPAIR****AUDIO UNIT****Removal and Installation**

INFOID:000000001345953

**REMOVAL**

1. Remove the cluster lid D. Refer to [JP-11, "Removal and Installation"](#).
2. Remove the cluster lid D screws (A), then remove the audio unit screws (B) and the audio unit (1).

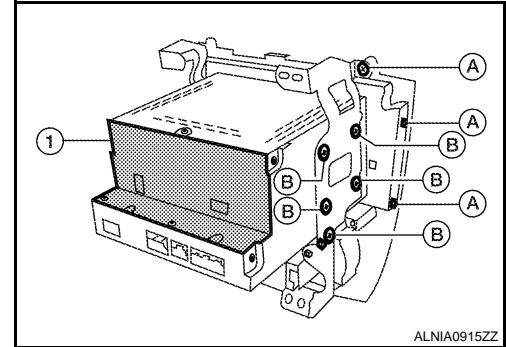
**INSTALLATION**

Installation is in the reverse order of removal.

## FRONT TWEETER

### Removal and Installation

INFOID:000000001345954

#### REMOVAL

1. Remove the front pillar finisher. Refer to [INT-19, "Removal and Installation"](#).
2. Remove tweeter speaker grille. Refer to [IP-11, "Removal and Installation"](#).
3. Remove the tweeter speaker screws (A), disconnect the tweeter speaker connector and remove the tweeter speaker (1).

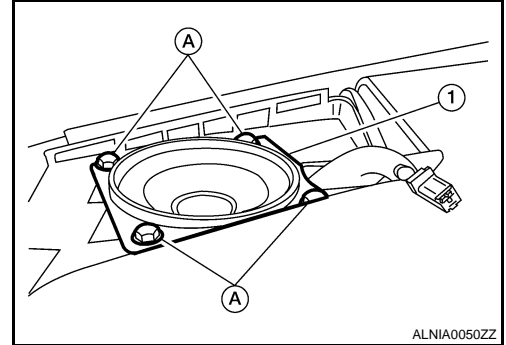

#### INSTALLATION

Installation is in the reverse order of removal.

A  
B  
C  
D  
E  
F  
G  
H  
I  
J  
K  
L  
M  
O  
P

AV

# FRONT DOOR SPEAKER

< ON-VEHICLE REPAIR >

[BASE AUDIO]

## FRONT DOOR SPEAKER

### Removal and Installation

INFOID:000000001345955

#### REMOVAL

1. Remove the front door finisher. Refer to [INT-11. "Removal and Installation"](#).
2. Remove the front door speaker screws (A), then disconnect the front door speaker connector and remove the front door speaker (1).

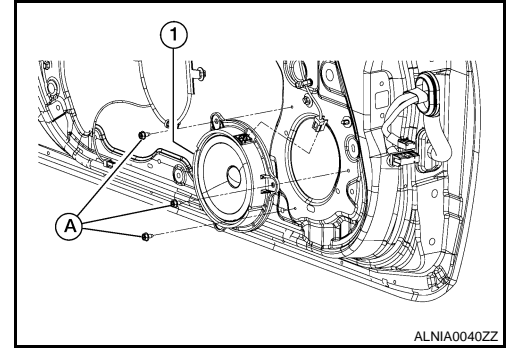

#### INSTALLATION

Installation is in the reverse order of removal.

# REAR SPEAKER

< ON-VEHICLE REPAIR >

[BASE AUDIO]

## REAR SPEAKER

### Removal and Installation - Coupe

INFOID:000000001345956

#### REMOVAL

1. Remove the trunk front finisher. Refer to [INT-22. "Removal and Installation"](#).
2. Remove the rear speaker screws (A), then disconnect the rear speaker connector (B) and remove the rear speaker (1).

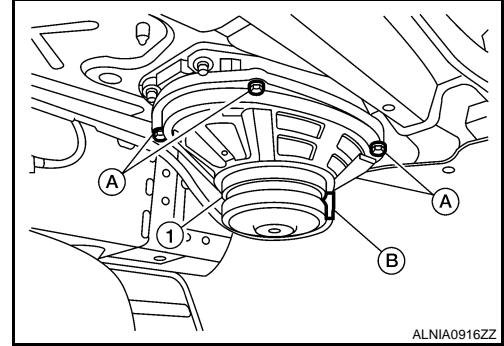

#### INSTALLATION

Installation is in the reverse order of removal.

### Removal and Installation - Sedan

INFOID:000000003110979

#### REMOVAL

1. Remove the rear parcel shelf finisher. Refer to [INT-36. "Removal and Installation"](#).
2. Remove the rear speaker screws (A), then disconnect the rear speaker and remove the rear speaker (1).

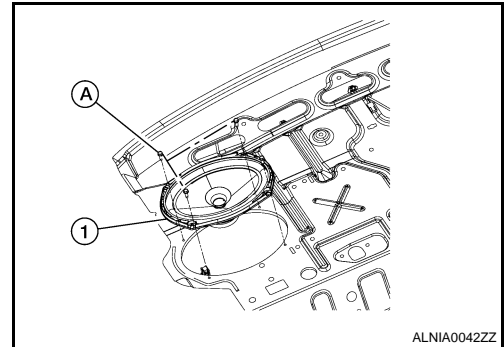

#### INSTALLATION

Installation is in the reverse order of removal.

A  
B  
C  
D  
E  
F  
G  
H  
I  
J  
K  
L  
M

AV

O  
P

## STEERING SWITCH

### Removal and Installation

INFOID:000000003110836

#### REMOVAL

1. Remove the driver airbag module. Refer to [SR-4, "Removal and Installation"](#).
2. Remove the steering wheel switch assembly screws (A), then remove the steering wheel switches (1).

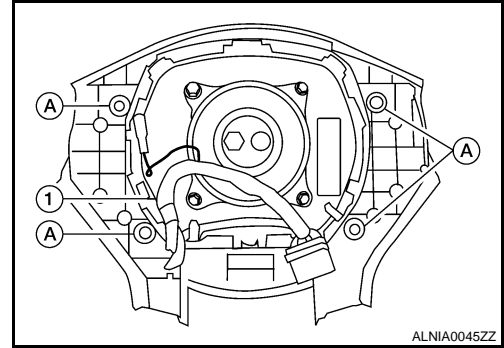

#### INSTALLATION

Installation is in the reverse order of removal.

# ANTENNA AMP.

< ON-VEHICLE REPAIR >

[BASE AUDIO]

## ANTENNA AMP.

### Removal and Installation - Coupe

INFOID:000000001345957

#### REMOVAL

1. Remove the rear pillar finisher RH. Refer to [INT-14, "Removal and Installation"](#).
2. Detach the antenna amp harness clip (B), disconnect the antenna amp connectors (A), remove the antenna amp screw (C) and remove the antenna amp (1).

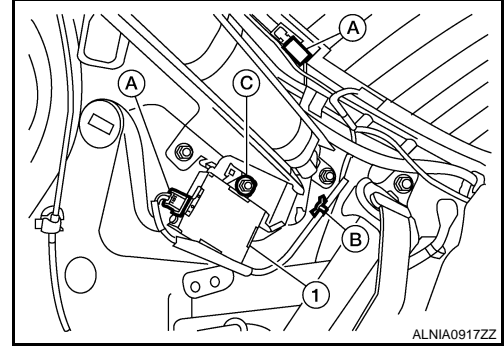

#### INSTALLATION

Installation is in the reverse order of removal.

### Removal and Installation - Sedan

INFOID:000000003110980

#### REMOVAL

1. Remove the rear pillar finisher RH. Refer to [INT-19, "Removal and Installation"](#).
2. Partially remove the side curtain air bag module RH to gain access to the antenna amp. Refer to [SR-10, "Removal and Installation"](#).
3. Detach the antenna amp harness clip (A), disconnect the antenna amp connectors (B), remove the antenna amp screw (C) and remove the antenna amp (1).

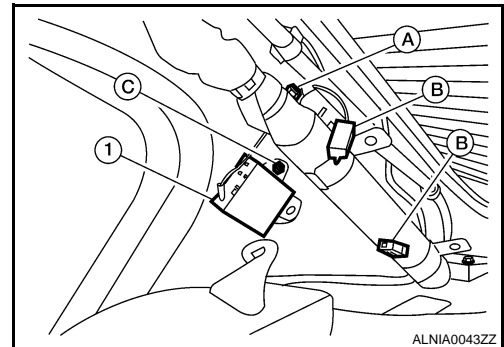

#### INSTALLATION

Installation is in the reverse order of removal.

A  
B  
C  
D  
E  
F  
G  
H  
I  
J  
K  
L  
M

AV

O  
P

# AUDIO ANTENNA (COUPE)

< ON-VEHICLE REPAIR >

[BASE AUDIO]

## AUDIO ANTENNA (COUPE)

### Location of Antenna

INFOID:000000001345958

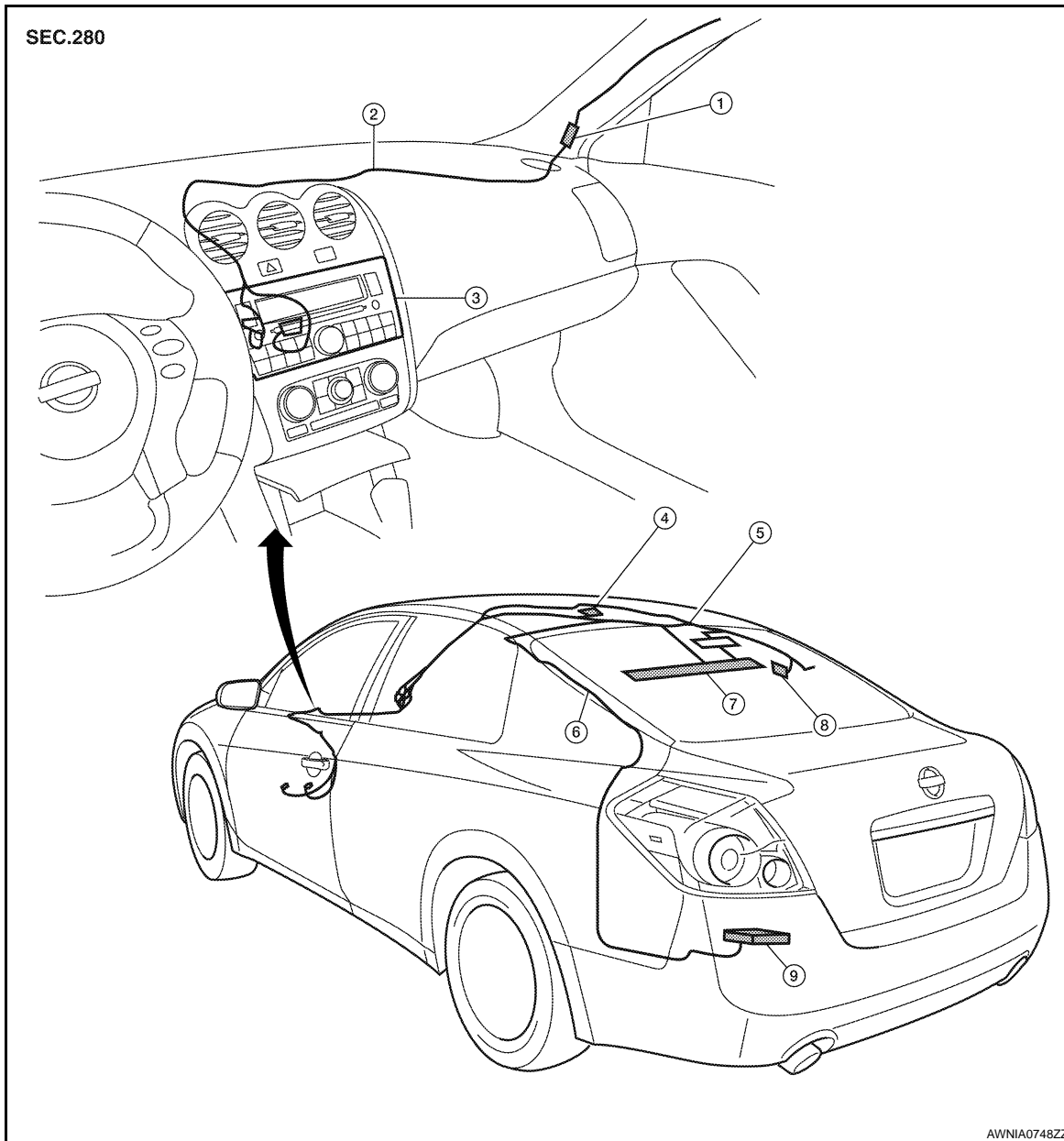

1. In-line connectors M87, M501

2. Audio unit harness

3. Audio unit

4. Satellite antenna

5. Audio antenna feeder

6. Satellite radio antenna feeder

7. Window Antenna

8. Antenna amp.

9. Satellite radio tuner

### Window Antenna Repair

INFOID:000000001345959

### ELEMENT CHECK



# AUDIO ANTENNA (COUPE)

< ON-VEHICLE REPAIR >

[BASE AUDIO]

1. Attach probe circuit tester (ohm setting) to antenna terminal on each side.

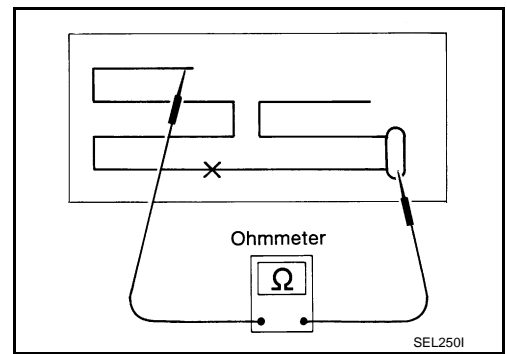

- When measuring continuity, wrap tin foil around the top of probe. Then, press the foil against the wire with your finger.

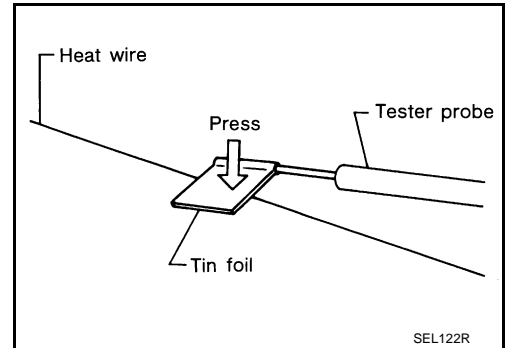

2. If an element is broken, no continuity will exist.

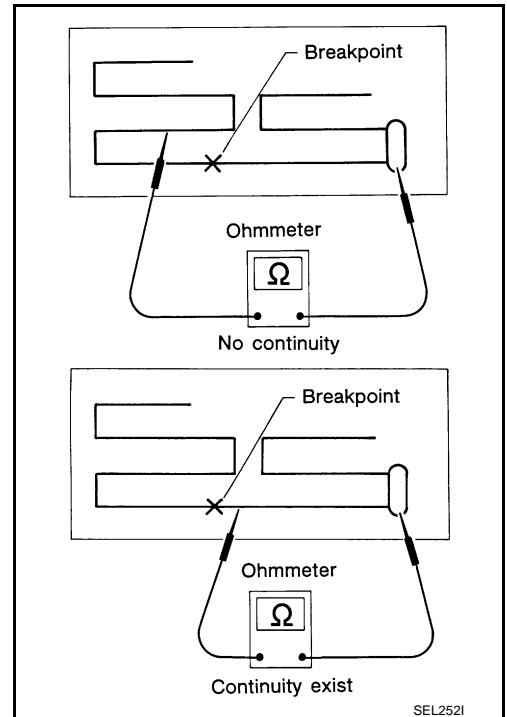

3. To locate a break, move probe along element. Tester indication will change abruptly when probe passes the broken point.

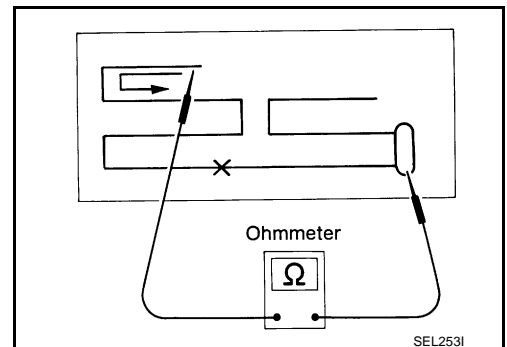

A  
B  
C  
D  
E  
F  
G  
H  
I  
J  
K  
L  
M  
AV  
O  
P

# AUDIO ANTENNA (COUPE)

< ON-VEHICLE REPAIR >

[BASE AUDIO]

## REPAIR EQUIPMENT

- Conductive silver composition (DuPont No. 4817 or equivalent)
- Ruler 30 cm (11.8 in) long
- Drawing pen
- Heat gun
- Alcohol
- Cloth

## REPAIRING PROCEDURE

1. Wipe broken heat wire and its surrounding area clean with a cloth dampened in alcohol.
2. Apply a small amount of conductive silver composition to tip of drawing pen. Shake silver composition container before use.
3. Place ruler on glass along broken line. Deposit conductive silver composition on break with drawing pen. Slightly overlap existing heat wire on both sides [preferably 5 mm (0.20 in)] of the break.

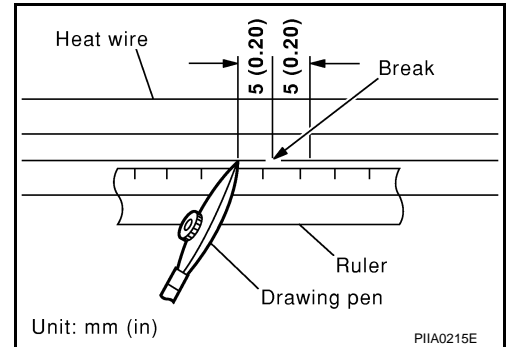

4. After repair has been completed, check repaired wire for continuity. This check should be conducted 10 minutes after silver composition is deposited. Do not touch repaired area while test is being conducted.

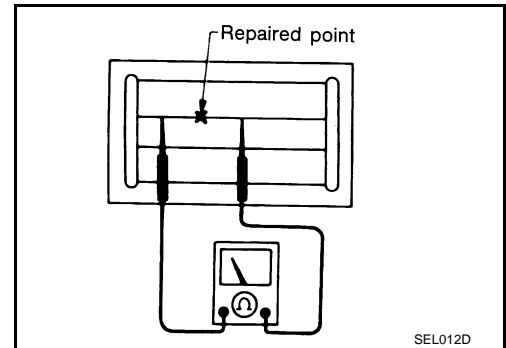

5. Apply a constant stream of hot air directly to the repaired area for approximately 20 minutes with a heat gun. A minimum distance of 3 cm (1.2 in) should be kept between repaired area and hot air outlet. If a heat gun is not available, let the repaired area dry for 24 hours.

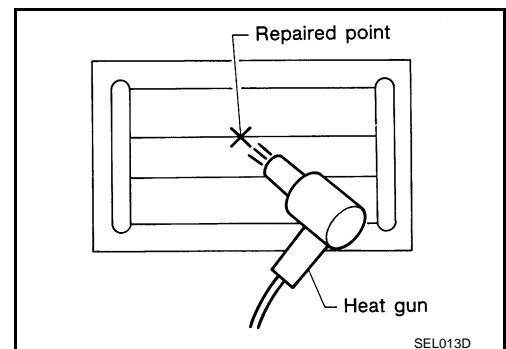

# AUDIO ANTENNA (SEDAN)

< ON-VEHICLE REPAIR >

[BASE AUDIO]

## AUDIO ANTENNA (SEDAN)

### Location of Antenna

INFOID:00000000322314

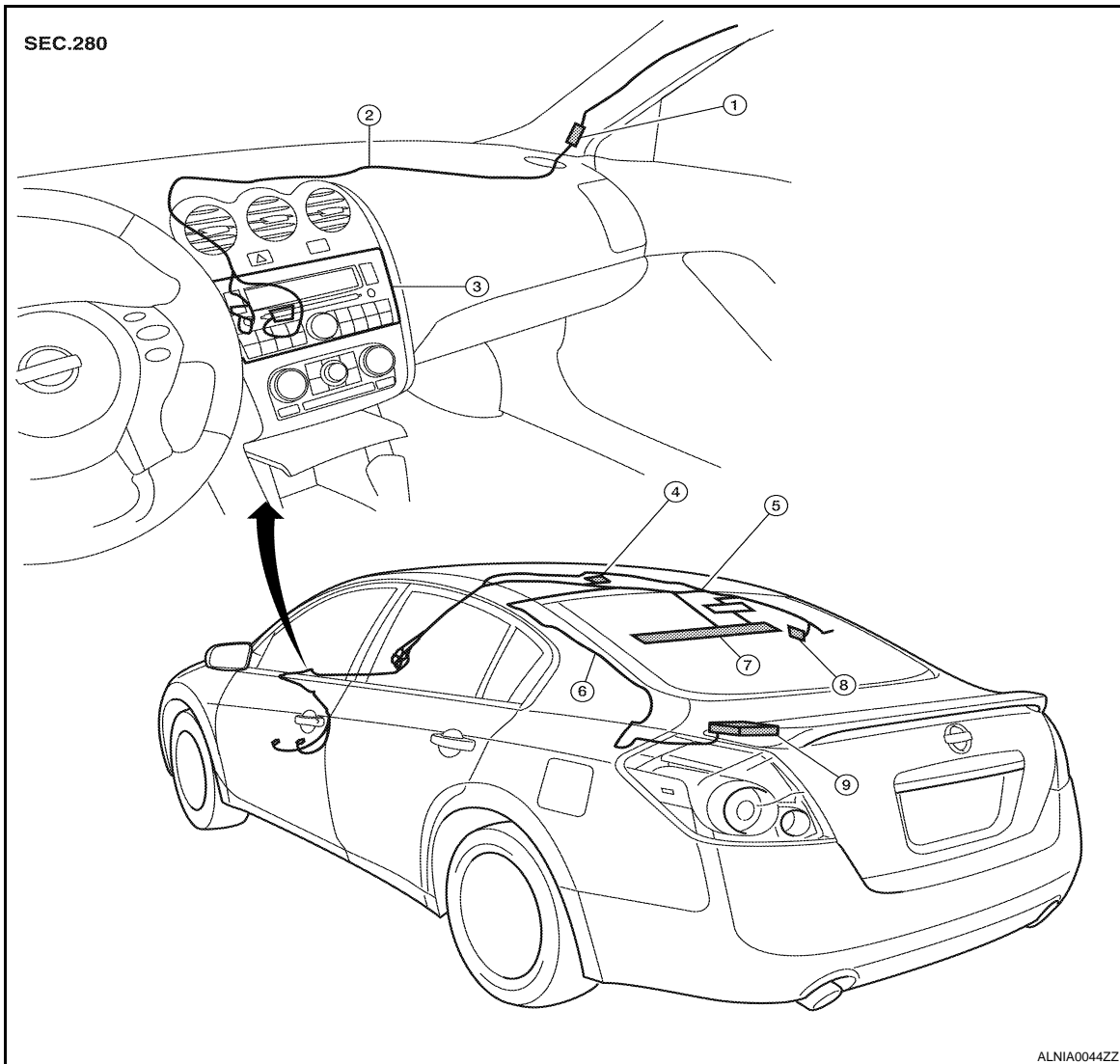

- |                                 |                         |                                   |
|---------------------------------|-------------------------|-----------------------------------|
| 1. In-line connectors M87, M501 | 2. Audio unit harness   | 3. Audio unit                     |
| 4. Satellite antenna            | 5. Audio antenna feeder | 6. Satellite radio antenna feeder |
| 7. Window Antenna               | 8. Antenna amp.         | 9. Satellite radio tuner          |

### Window Antenna Repair

INFOID:00000000322315

#### ELEMENT CHECK

1. Attach probe circuit tester (ohm setting) to antenna terminal on each side.

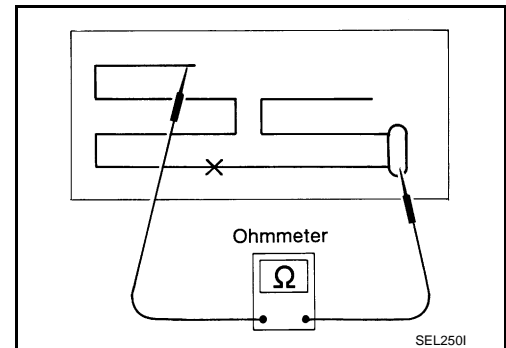

A  
B  
C  
D  
E  
F  
G  
H  
I  
J  
K  
L

M

AV

O

P

# AUDIO ANTENNA (SEDAN)

< ON-VEHICLE REPAIR >

[BASE AUDIO]

- When measuring continuity, wrap tin foil around the top of probe. Then, press the foil against the wire with your finger.

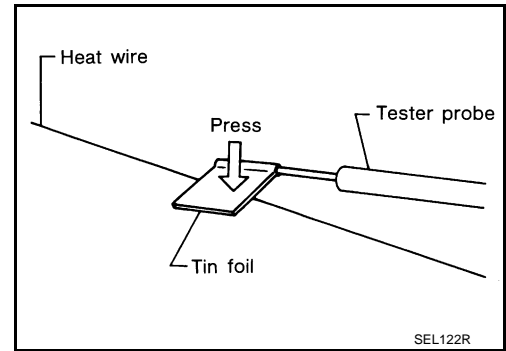

2. If an element is broken, no continuity will exist.

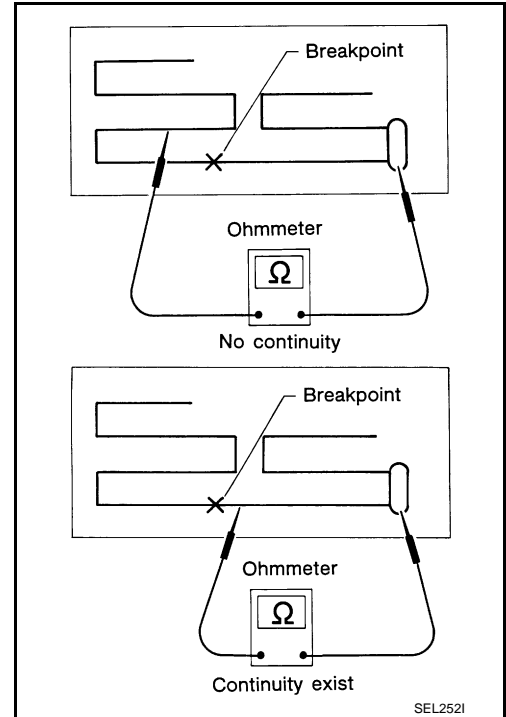

3. To locate a break, move probe along element. Tester indication will change abruptly when probe passes the broken point.

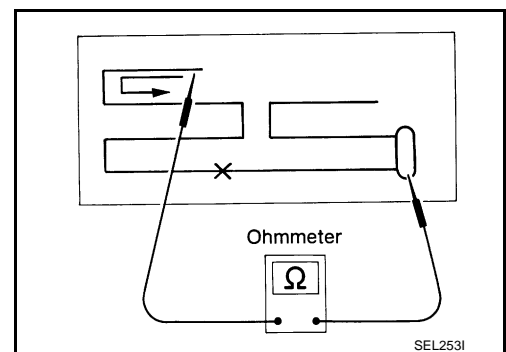

## REPAIR EQUIPMENT

- Conductive silver composition (DuPont No. 4817 or equivalent)
- Ruler 30 cm (11.8 in) long
- Drawing pen
- Heat gun
- Alcohol
- Cloth

## REPAIRING PROCEDURE

# AUDIO ANTENNA (SEDAN)

## < ON-VEHICLE REPAIR >

[BASE AUDIO]

1. Wipe broken heat wire and its surrounding area clean with a cloth dampened in alcohol.
2. Apply a small amount of conductive silver composition to tip of drawing pen. Shake silver composition container before use.
3. Place ruler on glass along broken line. Deposit conductive silver composition on break with drawing pen. Slightly overlap existing heat wire on both sides [preferably 5 mm (0.20 in)] of the break.

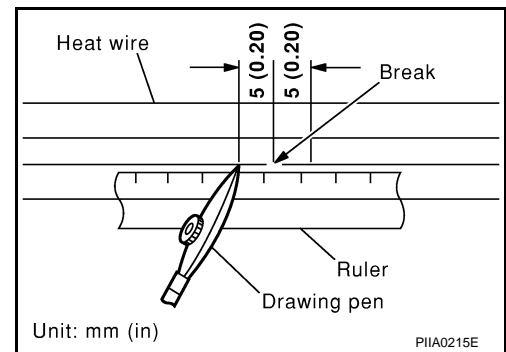

4. After repair has been completed, check repaired wire for continuity. This check should be conducted 10 minutes after silver composition is deposited. Do not touch repaired area while test is being conducted.

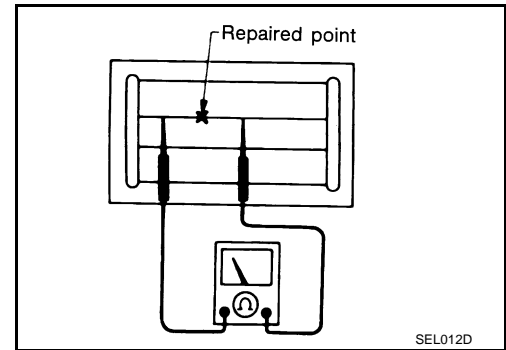

5. Apply a constant stream of hot air directly to the repaired area for approximately 20 minutes with a heat gun. A minimum distance of 3 cm (1.2 in) should be kept between repaired area and hot air outlet. If a heat gun is not available, let the repaired area dry for 24 hours.

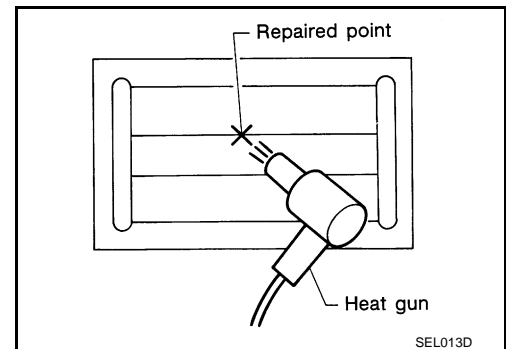

A  
B  
C  
D  
E  
F  
G  
H  
I  
J  
K  
L  
M  
O  
P

AV

## BASIC INSPECTION

### DIAGNOSIS AND REPAIR WORKFLOW

#### Work Flow

INFOID:000000001830598

#### OVERALL SEQUENCE

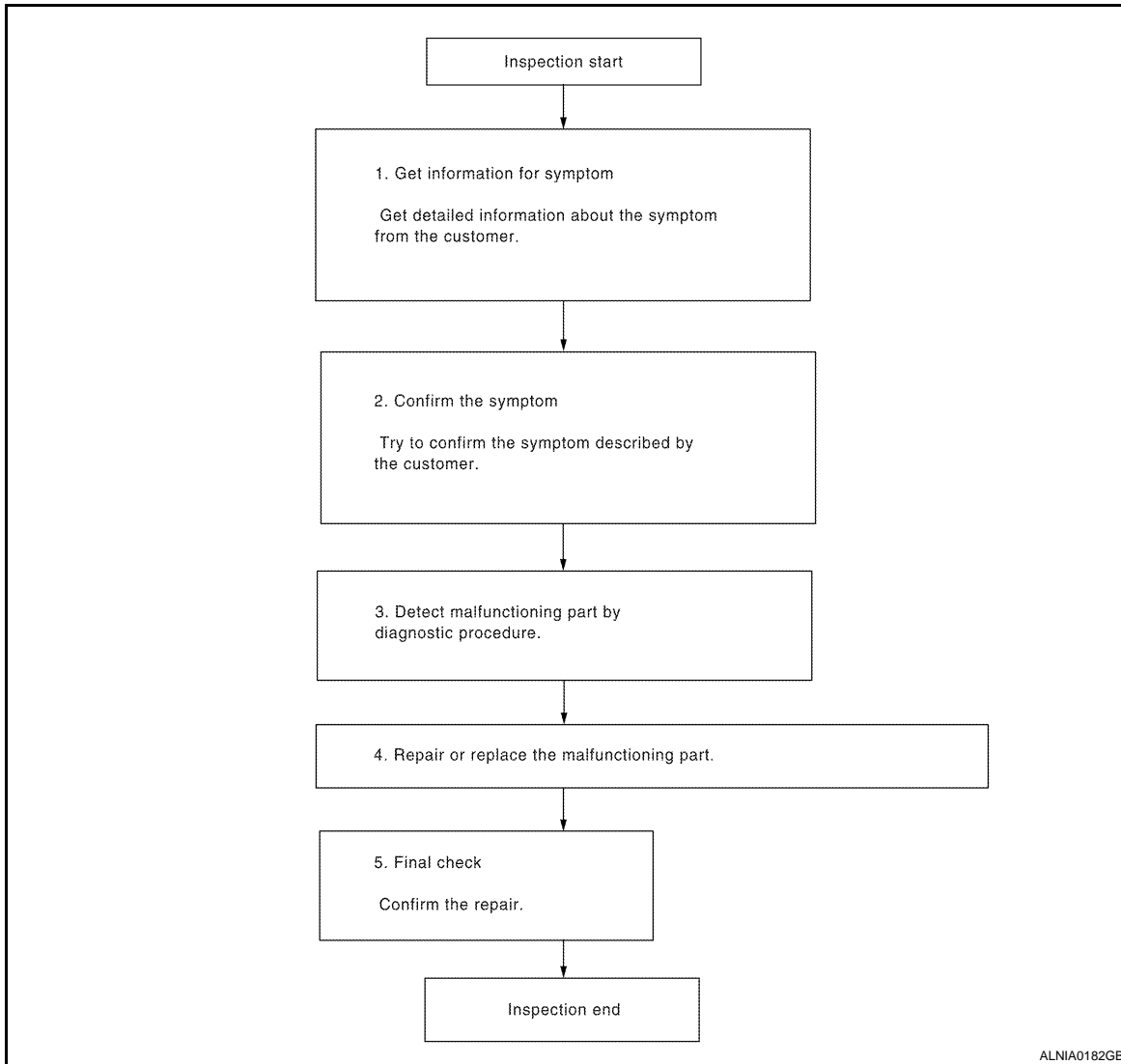

#### DETAILED FLOW

### 1.GET INFORMATION FOR SYMPTOM

Get detailed information from the customer about the symptom (the condition and the environment when the incident/malfunction occurred).

>> GO TO 2

### 2.CONFIRM THE SYMPTOM

Try to confirm the symptom described by the customer. Verify relation between the symptom and the condition when the symptom is detected.

>> GO TO 3

### 3.DETECT MALFUNCTIONING PART BY DIAGNOSTIC PROCEDURE

Inspect according to Diagnostic Procedure of the system.

# DIAGNOSIS AND REPAIR WORKFLOW

[BOSE AUDIO WITHOUT NAVIGATION]

< BASIC INSPECTION >

Is malfunctioning part detected?

YES >> GO TO 4

NO >> GO TO 2

## 4.REPAIR OR REPLACE THE MALFUNCTIONING PART

1. Repair or replace the malfunctioning part.
2. Reconnect parts or connectors disconnected during Diagnostic Procedure.

>> GO TO 5

## 5.FINAL CHECK

Refer to confirmed symptom in step 2, and make sure that the symptom is not detected.

Was the repair confirmed?

YES >> INSPECTION END.

NO >> GO TO 2

A

B

C

D

E

F

G

H

I

J

K

L

M

AV

O

P

## FUNCTION DIAGNOSIS

### AUDIO SYSTEM (COUPE)

#### System Diagram

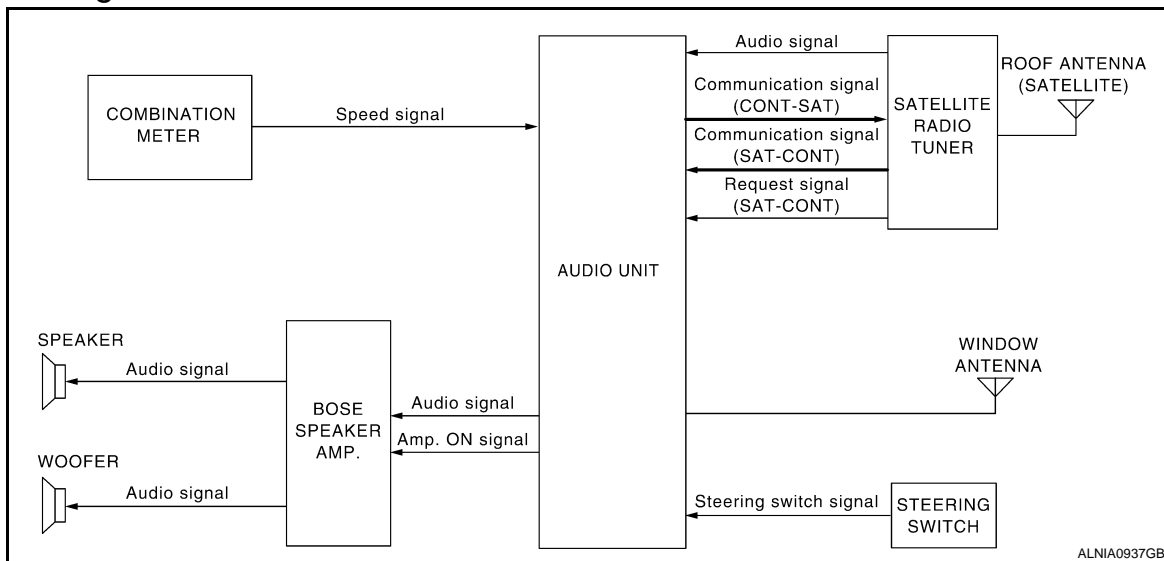

#### System Description

INFOID:000000001830600

##### AUDIO SYSTEM

The audio system consists of the following components

- Audio unit
- BOSE speaker amp.
- Window antenna
- Steering wheel audio control switches
- Door speakers
- Front tweeters
- Center speaker
- Rear tweeters
- Rear subwoofers

When the audio system is on, radio signals are received by the window antenna. The audio unit then sends audio signals to the BOSE speaker amp. The BOSE speaker amp. amplifies the audio signals before sending them to the door speakers, front tweeters, center speaker, rear tweeters and rear subwoofers.

Refer to Owner's Manual for audio system operating instructions.

##### SATELLITE RADIO SYSTEM

The satellite radio system consists of the following components

- Roof antenna (satellite)
- Satellite radio tuner

When the satellite radio system is on, radio signals are supplied to the satellite radio tuner from the satellite antenna. The satellite radio tuner then sends audio signals to the audio unit.

Refer to Owner's Manual for satellite radio system operating instructions.

##### SPEED SENSITIVE VOLUME SYSTEM

Volume level of this system goes up and down automatically in proportion to the vehicle speed. The control level can be selected by the customer. Refer to Owner's Manual for operating instructions.



# AUDIO SYSTEM (COUPE)

< FUNCTION DIAGNOSIS >

[BOSE AUDIO WITHOUT NAVIGATION]

## Component Parts Location

INFOID:000000001830601

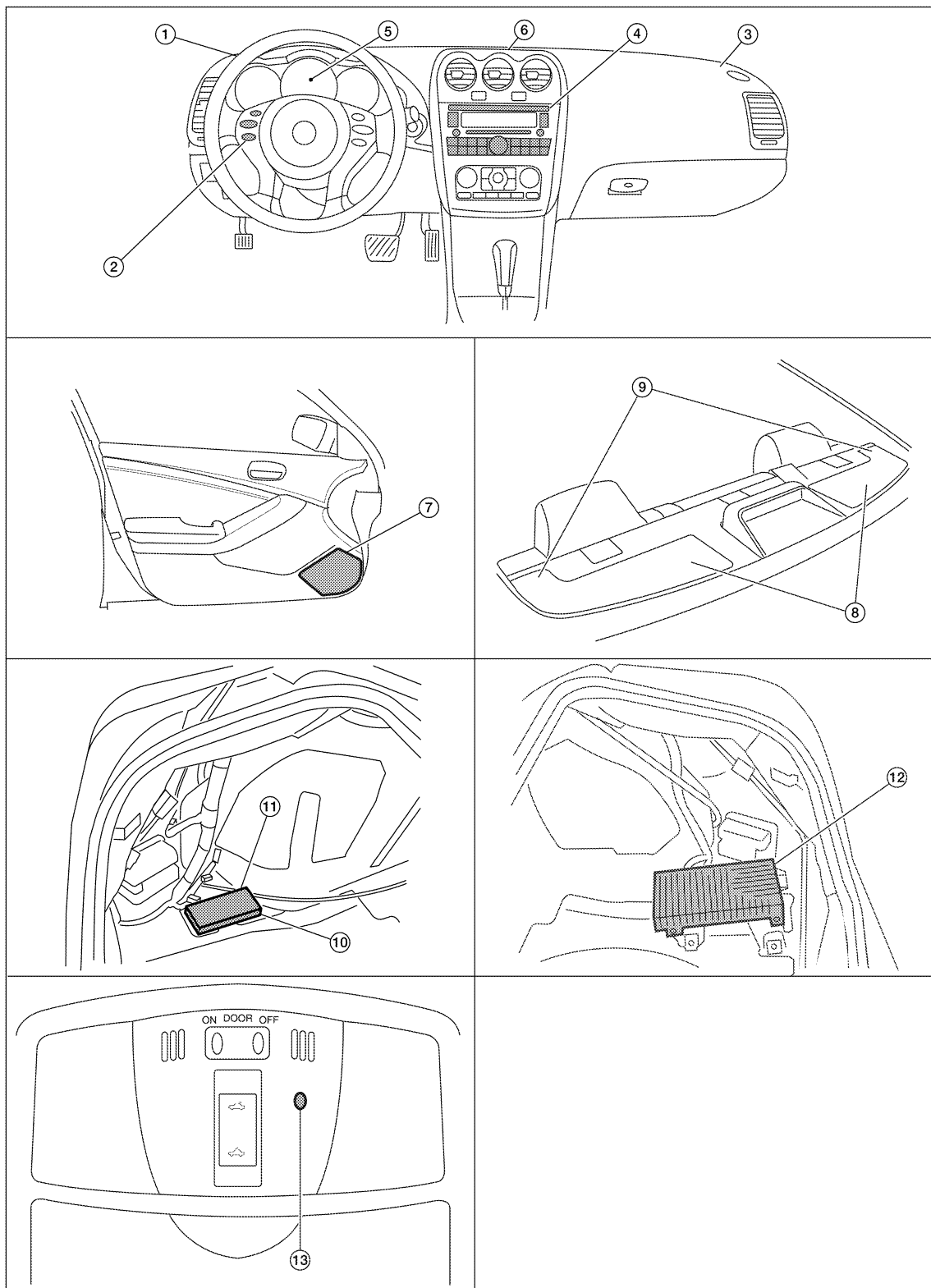

A  
B  
C  
D  
E  
F  
G  
H  
I  
J  
K  
L  
M  
AV  
O  
P

- |                                  |  |                         |
|----------------------------------|--|-------------------------|
| 1. Front tweeter LH M51          | 2. Steering wheel audio control switches | 3. Front tweeter RH M52 |
| 4. Audio unit M43, M44, M45, M81 | 5. Combination meter M24                 | 6. Center speaker M151  |

ALNIA0940GB

# AUDIO SYSTEM (COUPE)

[BOSE AUDIO WITHOUT NAVIGATION]

## < FUNCTION DIAGNOSIS >

- |   |                                       |  |
|---|---------------------------------------|--|
| 7. Door speaker<br>LH D3<br>RH D103   | 8. Rear subwoofer<br>LH B25<br>RH B47 | 9. Rear tweeter<br>LH B16<br>RH B100   |
| 10. Satellite radio tuner B57, B58<br>(viewed with trunk carpet and LH<br>floor spacer removed) | 11. Bluetooth control unit B55, B56   | 12. BOSE speaker amp B121, B122<br>(view with trunk carpet and RH floor<br>spacer removed) |
| 13. Microphone R7   |                                       |  |

## Component Description

INFOID:000000001830602

Part name	Description
Audio unit	Controls audio system and satellite radio system functions
BOSE speaker amp.	Receives power (amp ON) and audio signals from audio unit, and outputs audio signals to each speaker.
Steering wheel audio control switches	<ul style="list-style-type: none"><li>• Each audio operation can be operated</li><li>• Steering switch signal (operation signal) is output to audio unit</li></ul>
Door speakers	<ul style="list-style-type: none"><li>• Outputs audio signal from BOSE speaker amp.</li><li>• Outputs high, mid and low range sounds</li></ul>
Front tweeters	<ul style="list-style-type: none"><li>• Outputs audio signal from BOSE speaker amp.</li><li>• Outputs high range sounds</li></ul>
Center speaker	<ul style="list-style-type: none"><li>• Outputs audio signal from BOSE speaker amp.</li><li>• Outputs high range sounds</li></ul>
Rear tweeters	<ul style="list-style-type: none"><li>• Outputs audio signal from BOSE speaker amp.</li><li>• Outputs high range sounds</li></ul>
Rear subwoofers	<ul style="list-style-type: none"><li>• Outputs audio signal from BOSE speaker amp.</li><li>• Outputs low range sounds</li></ul>
Satellite radio tuner	<ul style="list-style-type: none"><li>• Receives radio signals from satellite antenna</li><li>• Sends audio signals to audio unit</li></ul>
Satellite antenna	Audio signal (satellite radio) is received and output to audio unit.

# AUDIO SYSTEM (SEDAN)

< FUNCTION DIAGNOSIS >

[BOSE AUDIO WITHOUT NAVIGATION]

## AUDIO SYSTEM (SEDAN)

### System Diagram

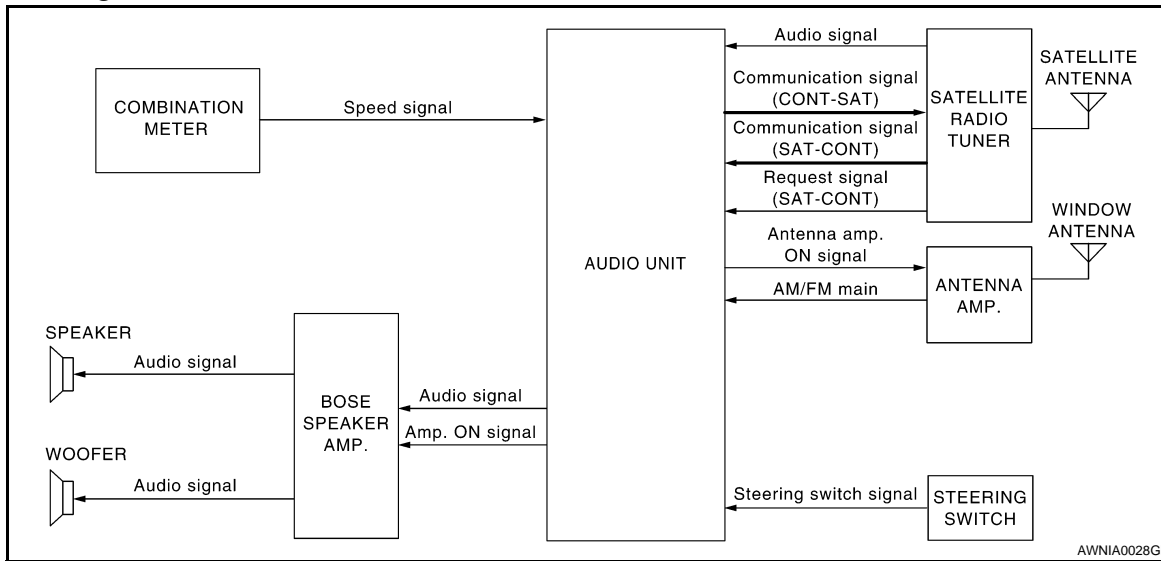

### System Description

INFOID:000000003222157

#### AUDIO SYSTEM

The audio system consists of the following components

- Audio unit
- Window antenna
- BOSE speaker amp.
- Steering wheel audio control switches
- Front door speakers
- Tweeters
- Center speaker
- Rear door speakers
- Rear subwoofers

When the audio system is on, radio signals are received by the window antenna. The audio unit then sends audio signals to BOSE speaker amp. The Bose speaker amp. sends the audio signals to the front door speakers, tweeters, center speaker, rear door speakers and rear subwoofers.

Refer to Owner's Manual for audio system operating instructions.

#### SATELLITE RADIO SYSTEM

The satellite radio system consists of the following components

- Roof antenna (satellite)
- Satellite radio tuner

When the satellite radio system is on, radio signals are supplied to the satellite radio tuner from the satellite antenna. The satellite radio tuner then sends audio signals to the audio unit.

Refer to Owner's Manual for satellite radio system operating instructions.

#### SPEED SENSITIVE VOLUME SYSTEM

Volume level of this system goes up and down automatically in proportion to the vehicle speed. The control level can be selected by the customer. Refer to Owner's Manual for operating instructions.

A  
B  
C  
D  
E  
F  
G  
H  
I  
J  
K  
L  
M  
AV  
O  
P

# AUDIO SYSTEM (SEDAN)

< FUNCTION DIAGNOSIS >

[BOSE AUDIO WITHOUT NAVIGATION]

## Component Parts Location

INFOID:000000003222158

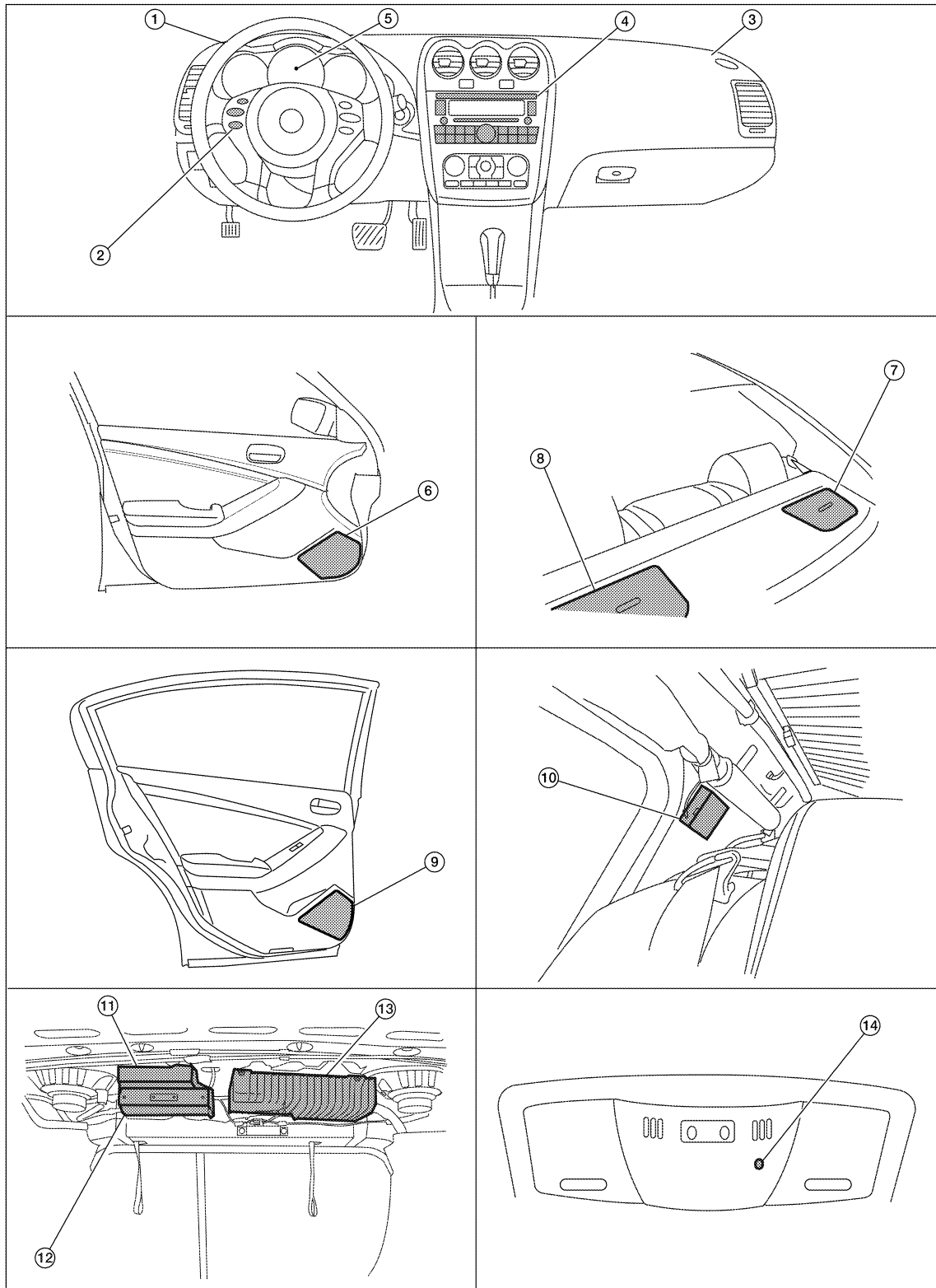

AWNIA0746ZZ

- |                                  |  |   |
|----------------------------------|--|---|
| 1. Tweeter LH M51                | 2. Steering wheel audio control switches | 3. Tweeter RH M52                         |
| 4. Audio unit M43, M44, M45, M81 | 5. Combination meter M24                 | 6. Front door speaker<br>LH D3<br>RH D103 |

# AUDIO SYSTEM (SEDAN)

[BOSE AUDIO WITHOUT NAVIGATION]

< FUNCTION DIAGNOSIS >

- |                                  |                                      |  |
|----------------------------------|--------------------------------------|--|
| 7. Rear subwoofer LH B120        | 8. Rear subwoofer RH B124            | 9. Rear door speaker<br>LH D202<br>RH D302 |
| 10. Antenna amp. M502            | 11. Satellite radio tuner B123, B129 | 12. Bluetooth control unit B125, B126      |
| 13. BOSE speaker amp. B121, B122 | 14. Microphone R7                    |  |

## Component Description

INFOID:000000003222159

Part name	Description
Audio unit	Controls audio system and satellite radio system functions
BOSE speaker amp.	Receives power (amp ON) and audio signals from audio unit, and outputs audio signals to each speaker.
Steering wheel audio control switches	<ul style="list-style-type: none"> <li>Each audio operation can be operated</li> <li>Steering switch signal (operation signal) is output to audio unit</li> </ul>
Front door speakers	<ul style="list-style-type: none"> <li>Outputs audio signal from BOSE speaker amp.</li> <li>Outputs high, mid and low range sounds</li> </ul>
Tweeters	<ul style="list-style-type: none"> <li>Outputs audio signal from BOSE speaker amp.</li> <li>Outputs high range sounds</li> </ul>
Center speaker	<ul style="list-style-type: none"> <li>Outputs audio signal from BOSE speaker amp.</li> <li>Outputs high range sounds</li> </ul>
Rear door speakers	<ul style="list-style-type: none"> <li>Outputs audio signal from BOSE speaker amp.</li> <li>Outputs high range sounds</li> </ul>
Rear subwoofers	<ul style="list-style-type: none"> <li>Outputs audio signal from BOSE speaker amp.</li> <li>Outputs low range sounds</li> </ul>
Satellite radio tuner	<ul style="list-style-type: none"> <li>Receives radio signals from satellite antenna</li> <li>Sends audio signals to audio unit</li> </ul>
Satellite antenna	Audio signal (satellite radio) is received and output to audio unit.

A  
B  
C  
D  
E  
F  
G  
H  
I  
J  
K  
L  
M  
O  
P

AV

# HANDS FREE PHONE SYSTEM (COUPE)

< FUNCTION DIAGNOSIS >

[BOSE AUDIO WITHOUT NAVIGATION]

## HANDS FREE PHONE SYSTEM (COUPE)

### System Diagram

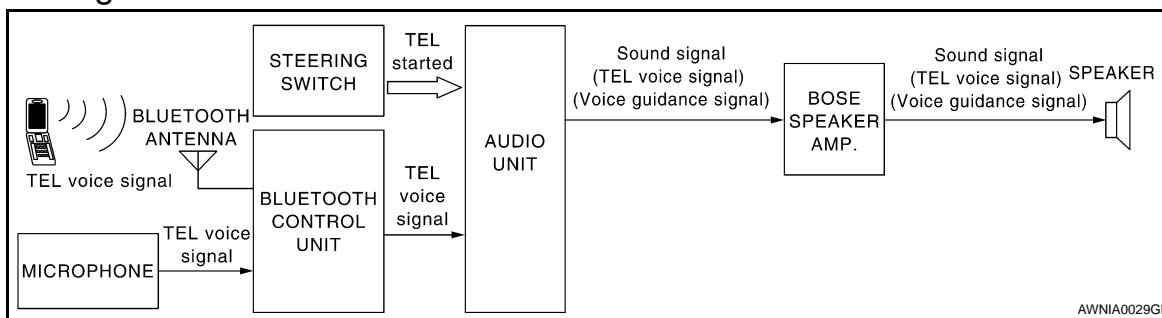

### System Description

INFOID:000000001830604

Refer to the owner's manual for Bluetooth telephone system operating instructions.

#### NOTE:

Cellular telephones must have their wireless connection set up (paired) before using the Bluetooth telephone system.

Bluetooth telephone system allows users who have a Bluetooth cellular telephone to make a wireless connection between their cellular telephone and the Bluetooth control unit. Hands-free cellular telephone calls can be sent and received. Personal memos can be created using the Nissan Voice Recognition system. Some Bluetooth cellular telephones may not be recognized by the Bluetooth control unit. When a cellular telephone or the Bluetooth control unit is replaced, the telephone must be paired with the Bluetooth control unit. Different cellular telephones may have different pairing procedures. Refer to the cellular telephone operating manual.

#### BLUETOOTH CONTROL UNIT

When the ignition switch is turned to ACC or ON, the Bluetooth control unit will power up. During power up, the Bluetooth control unit is initialized and performs various self checks. Initialization may take up to 10 seconds. If a phone is present in the vehicle and paired with the Bluetooth control unit, Nissan Voice Recognition will then become active. Bluetooth telephone functions can be turned off using the Nissan Voice Recognition system.

#### STEERING WHEEL AUDIO CONTROL SWITCHES

When buttons on the steering wheel audio control switch are pushed, the resistance in steering wheel audio control switch circuit changes depending on which button is pushed. The Bluetooth control unit uses this signal to perform various functions while navigating through the voice recognition system.

The following functions can be performed using the steering wheel audio control switch:

- Initiate Self Diagnosis of the Bluetooth telephone system
- Start a voice recognition session
- Answer and end telephone calls
- Adjust the volume of calls
- Record memos

#### MICROPHONE

The microphone is located in the roof console assembly. The microphone sends a signal to the Bluetooth control unit. The microphone can be actively tested during self-diagnosis.

#### AUDIO UNIT

The audio unit receives signals from the Bluetooth control unit and sends audio signals to the speakers.

# HANDS FREE PHONE SYSTEM (COUPE)

< FUNCTION DIAGNOSIS >

[BOSE AUDIO WITHOUT NAVIGATION]

## Component Parts Location

INFOID:000000003222326

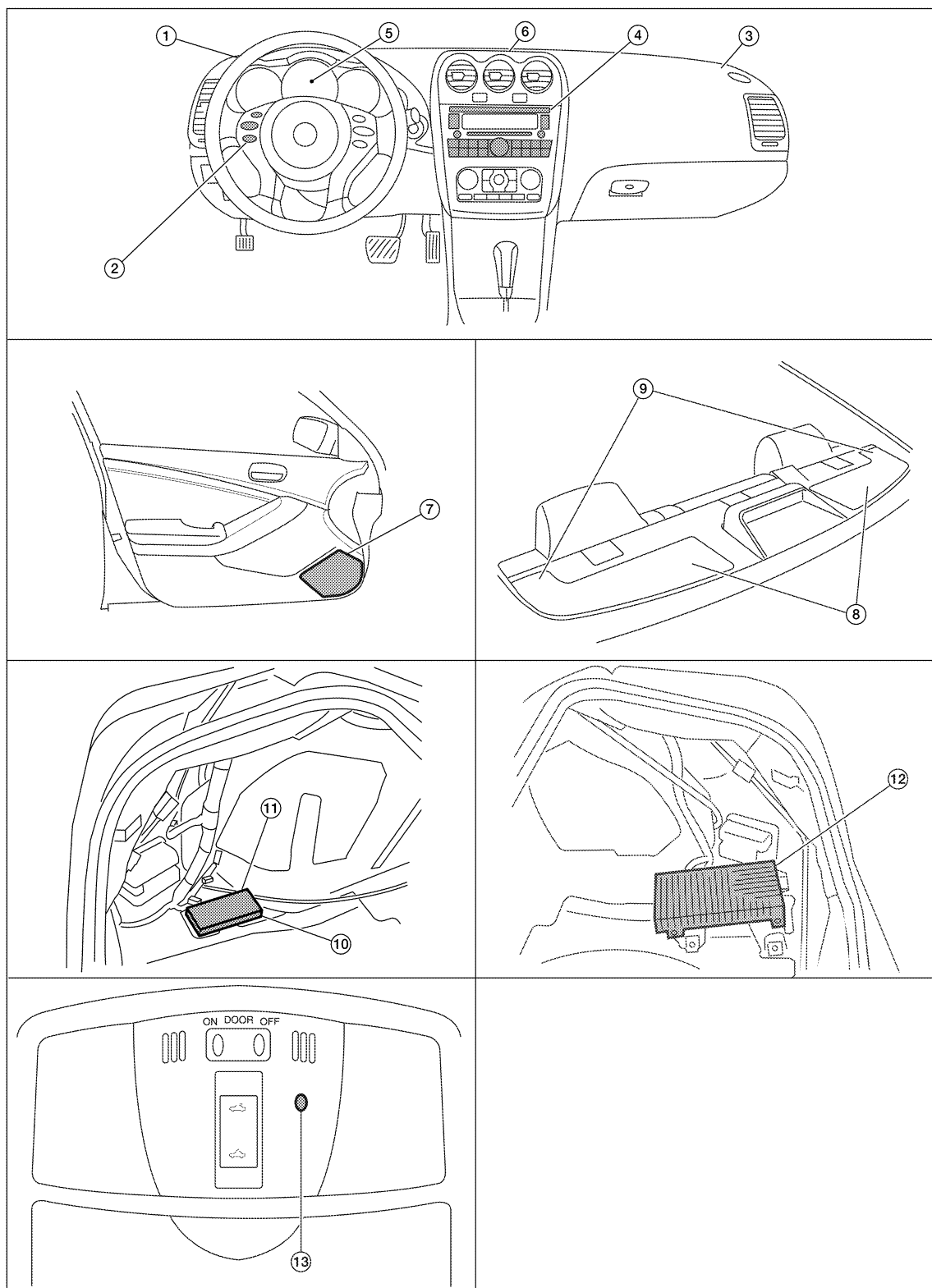

A  
B  
C  
D  
E  
F  
G  
H  
I  
J  
K  
L  
M  
AV  
O  
P

- |                                  |  |                         |
|----------------------------------|--|-------------------------|
| 1. Front tweeter LH M51          | 2. Steering wheel audio control switches | 3. Front tweeter RH M52 |
| 4. Audio unit M43, M44, M45, M81 | 5. Combination meter M24                 | 6. Center speaker M151  |

ALNIA0940GB

# HANDS FREE PHONE SYSTEM (COUPE)

[BOSE AUDIO WITHOUT NAVIGATION]

## < FUNCTION DIAGNOSIS >

- |   |                                       |  |
|---|---------------------------------------|--|
| 7. Door speaker<br>LH D3<br>RH D103   | 8. Rear subwoofer<br>LH B25<br>RH B47 | 9. Rear tweeter<br>LH B16<br>RH B100   |
| 10. Satellite radio tuner B57, B58<br>(viewed with trunk carpet and LH<br>floor spacer removed) | 11. Bluetooth control unit B55, B56   | 12. BOSE speaker amp B121, B122<br>(view with trunk carpet and RH floor<br>spacer removed) |
| 13. Microphone R7   |                                       |  |

## Component Description

INFOID:000000001830606

Part name	Description
Audio unit	<ul style="list-style-type: none"><li>Receives telephone voice signal from Bluetooth control unit</li><li>Sends telephone voice and voice guidance signals to BOSE speaker amp.</li></ul>
BOSE speaker amp.	Inputs power (amp ON) and sound signal from audio unit, and outputs sound signal to each speaker.
Door speaker	Receives telephone voice and voice guidance signals from BOSE speaker amp.
Front tweeter	
Center speaker	
Steering wheel audio control switches	<ul style="list-style-type: none"><li>Start a voice recognition session</li><li>Answer and end telephone calls</li><li>Adjust the volume level</li></ul>
Microphone	Sends voice signals to Bluetooth control unit
Bluetooth control unit	Controls hands-free phone functions
Bluetooth antenna	Sends telephone voice signal to bluetooth control unit



# HANDS FREE PHONE SYSTEM (SEDAN)

< FUNCTION DIAGNOSIS >

[BOSE AUDIO WITHOUT NAVIGATION]

## HANDS FREE PHONE SYSTEM (SEDAN)

### System Diagram

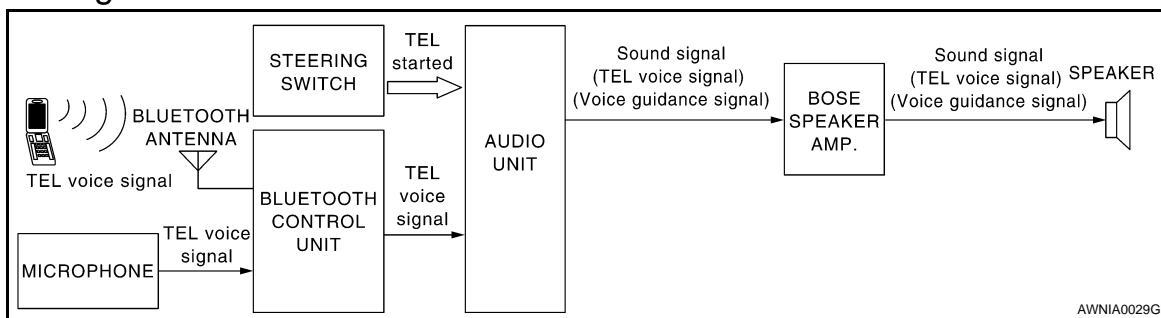

### System Description

INFOID:000000003222321

Refer to the owner's manual for Bluetooth telephone system operating instructions.

#### NOTE:

Cellular telephones must have their wireless connection set up (paired) before using the Bluetooth telephone system.

Bluetooth telephone system allows users who have a Bluetooth cellular telephone to make a wireless connection between their cellular telephone and the Bluetooth control unit. Hands-free cellular telephone calls can be sent and received. Personal memos can be created using the Nissan Voice Recognition system. Some Bluetooth cellular telephones may not be recognized by the Bluetooth control unit. When a cellular telephone or the Bluetooth control unit is replaced, the telephone must be paired with the Bluetooth control unit. Different cellular telephones may have different pairing procedures. Refer to the cellular telephone operating manual.

#### BLUETOOTH CONTROL UNIT

When the ignition switch is turned to ACC or ON, the Bluetooth control unit will power up. During power up, the Bluetooth control unit is initialized and performs various self checks. Initialization may take up to 10 seconds. If a phone is present in the vehicle and paired with the Bluetooth control unit, Nissan Voice Recognition will then become active. Bluetooth telephone functions can be turned off using the Nissan Voice Recognition system.

#### STEERING WHEEL AUDIO CONTROL SWITCHES

When buttons on the steering wheel audio control switch are pushed, the resistance in steering wheel audio control switch circuit changes depending on which button is pushed. The Bluetooth control unit uses this signal to perform various functions while navigating through the voice recognition system.

The following functions can be performed using the steering wheel audio control switch:

- Initiate Self Diagnosis of the Bluetooth telephone system
- Start a voice recognition session
- Answer and end telephone calls
- Adjust the volume of calls
- Record memos

#### MICROPHONE

The microphone is located in the roof console assembly. The microphone sends a signal to the Bluetooth control unit. The microphone can be actively tested during self-diagnosis.

#### AUDIO UNIT

The audio unit receives signals from the Bluetooth control unit and sends audio signals to the speakers.

# HANDS FREE PHONE SYSTEM (SEDAN)

< FUNCTION DIAGNOSIS >

[BOSE AUDIO WITHOUT NAVIGATION]

## Component Parts Location

INFOID:00000000322327

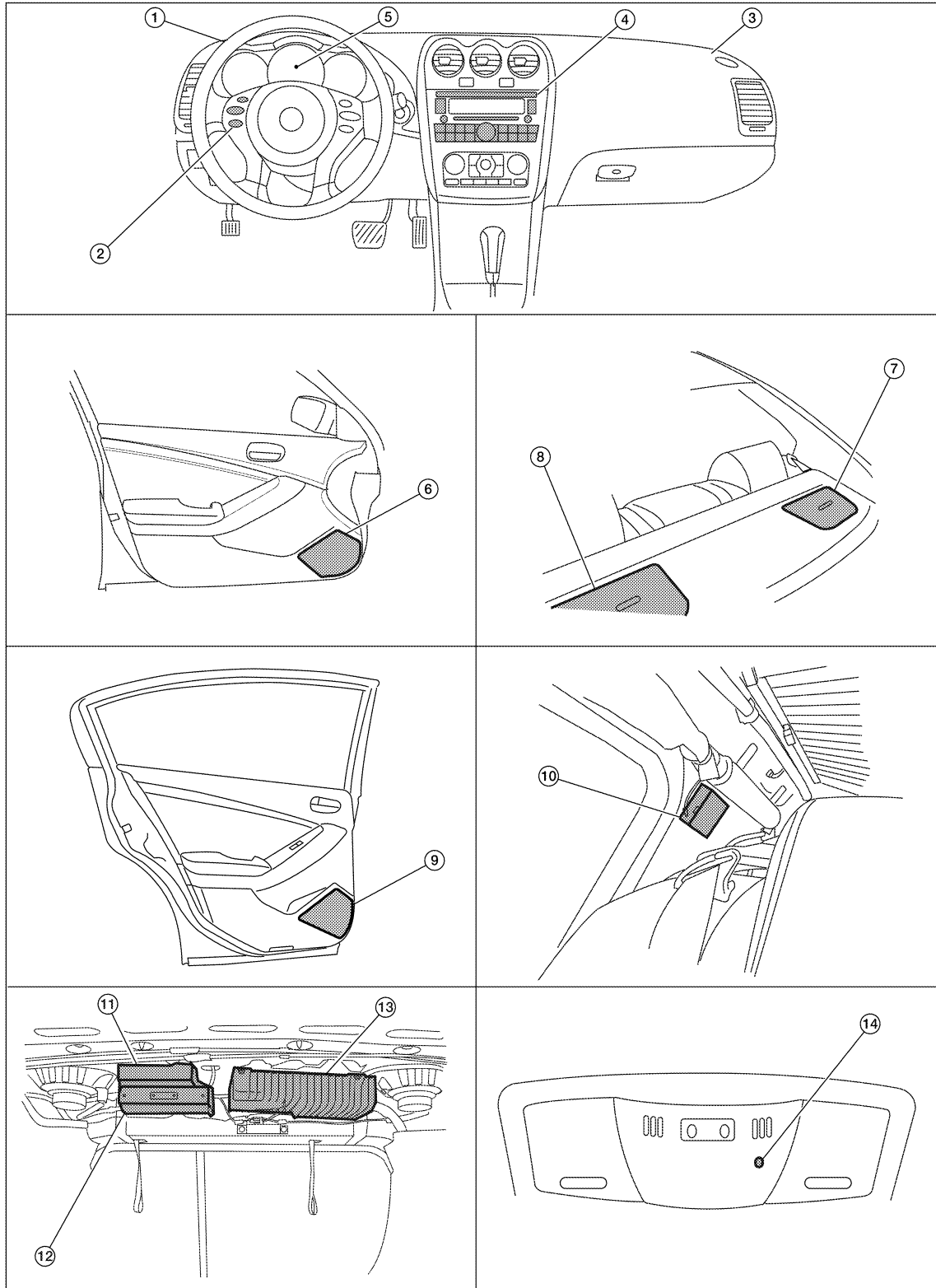

AWNIA0746ZZ

- |                                  |  |   |
|----------------------------------|--|---|
| 1. Tweeter LH M51                | 2. Steering wheel audio control switches | 3. Tweeter RH M52                         |
| 4. Audio unit M43, M44, M45, M81 | 5. Combination meter M24                 | 6. Front door speaker<br>LH D3<br>RH D103 |

# HANDS FREE PHONE SYSTEM (SEDAN)

[BOSE AUDIO WITHOUT NAVIGATION]

< FUNCTION DIAGNOSIS >

- |                                  |                                      |  |
|----------------------------------|--------------------------------------|--|
| 7. Rear subwoofer LH B120        | 8. Rear subwoofer RH B124            | 9. Rear door speaker<br>LH D202<br>RH D302 |
| 10. Antenna amp. M502            | 11. Satellite radio tuner B123, B129 | 12. Bluetooth control unit B125, B126      |
| 13. BOSE speaker amp. B121, B122 | 14. Microphone R7                    |  |

## Component Description

INFOID:000000003222325

Part name	Description
Audio unit	<ul style="list-style-type: none"> <li>Receives telephone voice signal from Bluetooth control unit</li> <li>Sends telephone voice and voice guidance signals to BOSE speaker amp.</li> </ul>
BOSE speaker amp.	Inputs power (amp ON) and sound signal from audio unit, and outputs sound signal to each speaker.
Front door speaker	Receives telephone voice and voice guidance signals from BOSE speaker amp.
Tweeter	
Center speaker	
Steering wheel audio control switches	<ul style="list-style-type: none"> <li>Start a voice recognition session</li> <li>Answer and end telephone calls</li> <li>Adjust the volume level</li> </ul>
Microphone	Sends voice signals to Bluetooth control unit
Bluetooth control unit	Controls hands-free phone functions
Bluetooth antenna	Sends telephone voice signal to bluetooth control unit

AV

# DIAGNOSIS SYSTEM (AUDIO UNIT)

[BOSE AUDIO WITHOUT NAVIGATION]

< FUNCTION DIAGNOSIS >

## DIAGNOSIS SYSTEM (AUDIO UNIT)

### Diagnosis Description

INFOID:000000001830607

Self-diagnosis mode can check the following items.

- Audio unit hardware/software versions
- Continuity of each speaker channel
- Continuity of each audio unit switch

### OPERATION PROCEDURE

1. Turn ignition switch to the ACC position.
2. Turn the audio unit off.
3. While pressing the “AUDIO” button, turn the volume control dial clockwise or counterclockwise 30 clicks or more. When the self-diagnosis mode is started, a short beep will be heard.

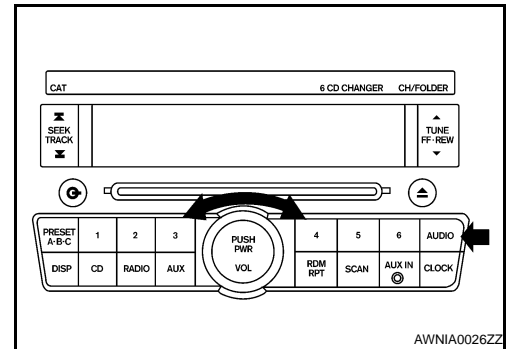

4. Initially, all display segments will be illuminated.

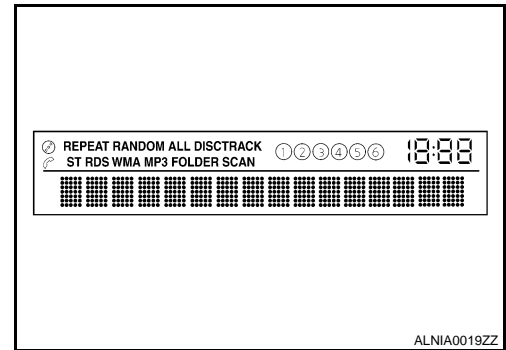

### Version Check

1. Press the “AUDIO” switch to enter version diagnostics. “Software” (audio software version) is displayed.

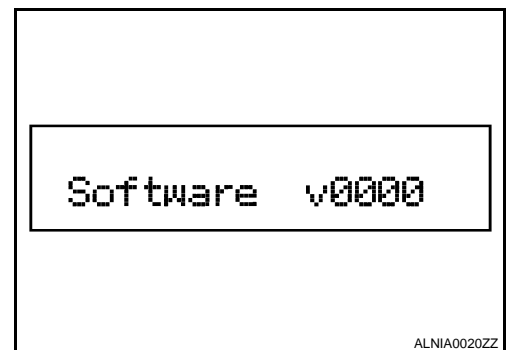

# DIAGNOSIS SYSTEM (AUDIO UNIT)

[BOSE AUDIO WITHOUT NAVIGATION]

< FUNCTION DIAGNOSIS >

2. Press the "AUDIO" switch again to display the "Hardware" (audio hardware version).



A  
B  
C  
D

3. Press the "AUDIO" switch again to display the "CD Mech" (CD mechanism version).



E  
F  
G

4. Press the "AUDIO" switch again to display the "SDARS" (satellite radio version).



H  
I  
J  
K

## Channel Check Diagnostics

When all segments are illuminated, press the "TUNE" up switch to enter channel check diagnostics. The self-diagnostic function will then send a tone to each channel (FL, RL, RR, FR) for 1 second.



L  
M

AV

## Button Check Diagnostics

O  
P

## DIAGNOSIS SYSTEM (AUDIO UNIT)

< FUNCTION DIAGNOSIS >

[BOSE AUDIO WITHOUT NAVIGATION]

When all segments are illuminated, press the "TUNE" down switch to enter button check diagnostics. When each audio unit switch is pressed, a tone will sound and the switch name will be displayed.

BUTTON CHECK

ALNIA0025ZZ

# DIAGNOSIS SYSTEM (BLUETOOTH CONTROL UNIT)

< FUNCTION DIAGNOSIS >

[BOSE AUDIO WITHOUT NAVIGATION]

## DIAGNOSIS SYSTEM (BLUETOOTH CONTROL UNIT)

### Diagnosis Description

INFOID:000000001830608

The Bluetooth control unit has two diagnostic checks. The first diagnostic check is performed automatically every ignition cycle during control unit initialization. The second diagnostic check is performed by the technician using the steering wheel audio control switches prior to trouble diagnosis.

### BLUETOOTH CONTROL UNIT INITIALIZATION CHECKS

- Internal control unit failure
- Bluetooth antenna connection open or shorted
- Steering wheel audio control switches (SEND/END) stuck closed
- Vehicle speed pulse count
- Microphone connection test (with playback to operator)
- Bluetooth inquiry check

### OPERATION PROCEDURE

1. Turn ignition switch to ACC or ON.
2. Wait for the Bluetooth system to complete initialization. This may take up to 10 seconds.
3. Press and hold the steering wheel audio control switch SEND button for at least 5 seconds. The Bluetooth system will begin to play a verbal prompt.

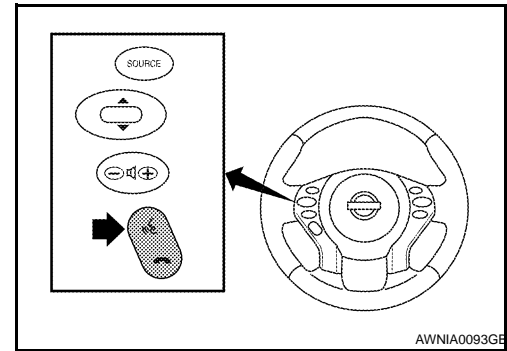

4. While the prompt is playing, press and hold the steering wheel audio control switch END button until you hear the "Diagnostics mode" prompt. The Bluetooth system will sound a 5 second beep.
5. While the beep is sounding, press and hold the steering wheel audio control switch END button again until you hear prompts.
6. The Bluetooth system has now entered into the diagnostic mode. Results of the diagnostic checks will be verbalized to the technician. Refer to [AV-99. "Work Flow"](#).
7. After the failure records are reported, an interactive microphone test will be performed. Follow the voice prompt. If the microphone test fails refer to [AV-99. "Work Flow"](#).
8. Self-diagnosis mode is complete when the voice prompt says "All diagnostic functions completed".

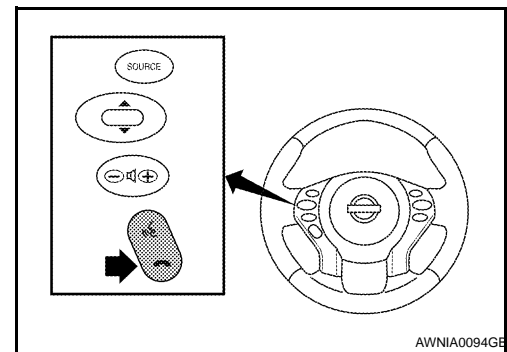

### Work Flow

INFOID:000000001830609

Failure Message	Action
"Internal failure"	Replace Bluetooth control unit. For coupe, refer to <a href="#">AV-227. "Removal and Installation - Coupe"</a> . For sedan, refer to <a href="#">AV-227. "Removal and Installation - Sedan"</a> .
"Bluetooth antenna open"	<ol style="list-style-type: none"> <li>1. Inspect harness connection.</li> <li>2. Replace Bluetooth antenna. For coupe, refer to <a href="#">AV-226. "Removal and Installation - Coupe"</a>. For sedan, refer to <a href="#">AV-226. "Removal and Installation - Sedan"</a>.</li> </ol>
"Bluetooth antenna shorted"	
"Phone/Send for Hands Free System is stuck"	Check steering wheel audio control switches. Refer to <a href="#">AV-134. "Diagnosis Procedure"</a> .
"Phone/End for the Hands Free System is stuck"	
"Microphone test" (failed interactive test)	<ol style="list-style-type: none"> <li>1. Inspect harness between Bluetooth control unit and microphone.</li> <li>2. Replace microphone. For coupe, refer to <a href="#">AV-224. "Removal and Installation - Coupe"</a>. For sedan, refer to <a href="#">AV-224. "Removal and Installation - Coupe"</a>.</li> </ol>

A  
B  
C  
D  
E  
F  
G  
H  
I  
J  
K  
L  
M

# POWER SUPPLY AND GROUND CIRCUIT (COUPE)

< COMPONENT DIAGNOSIS >

[BOSE AUDIO WITHOUT NAVIGATION]

## COMPONENT DIAGNOSIS

### POWER SUPPLY AND GROUND CIRCUIT (COUPE)

#### AUDIO UNIT

#### AUDIO UNIT : Diagnosis Procedure

INFOID:000000003188232

#### 1.CHECK FUSES

Check that the following fuses are not blown.

Unit	Terminals	Signal name	Fuse No.
Audio unit	19	Battery power	24
	7	Ignition switch ACC or ON	19

Are the fuses OK?

YES >> GO TO 2

NO >> If fuse is blown, be sure to eliminate cause of malfunction before installing new fuse.

#### 2.POWER SUPPLY CIRCUIT CHECK

1. Disconnect audio unit connector M43.
2. Check voltage between the audio unit connector M43 and ground.

(+) Connector		(-)	OFF	ACC	ON
Terminal					
M43	19	Ground	Battery voltage	Battery voltage	Battery voltage
	7	Ground	0V	Battery voltage	Battery voltage

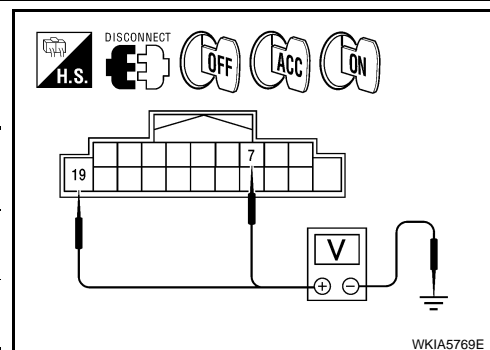

Are the voltage results as specified?

YES >> GO TO 3

NO >> • Check connector housings for disconnected or loose terminals.  
• Repair harness or connector.

#### 3.GROUND CIRCUIT CHECK

Inspect audio unit case ground.

Does case ground pass inspection?

YES >> Inspection End.

NO >> Repair audio unit case ground.

#### BOSE SPEAKER AMP

#### BOSE SPEAKER AMP : Diagnosis Procedure

INFOID:000000001830611

#### 1.CHECK FUSE

Check for blown fuses.

Unit	Terminals	Signal name	Fuse No.
BOSE speaker amp.	50	Battery power	25
	51		26

Are the fuses OK?

YES >> GO TO 2

NO >> Be sure to eliminate cause of malfunction before installing new fuse.

#### 2.CHECK POWER SUPPLY CIRCUIT



# POWER SUPPLY AND GROUND CIRCUIT (COUPE)

[BOSE AUDIO WITHOUT NAVIGATION]

## < COMPONENT DIAGNOSIS >

1. Turn ignition switch OFF.
2. Disconnect BOSE speaker amp connector.
3. Check voltage between BOSE speaker amp harness connector and ground.

(+)		(-)	Voltage (approx.)
Connector	Terminal		
B122	50	Ground	Battery voltage
	51		

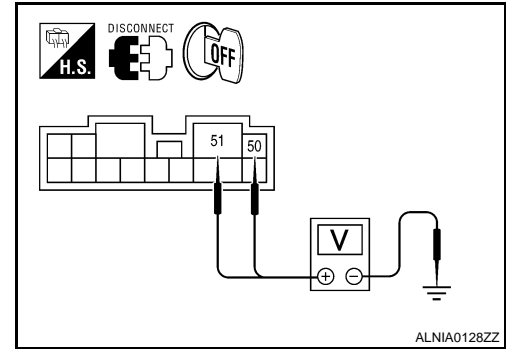

Is battery voltage present?

YES >> GO TO 3

NO >> Check harness between BOSE speaker amp and fuse.

### 3.CHECK GROUND CIRCUIT

1. Turn ignition switch OFF.
2. Disconnect BOSE speaker amp connector.
3. Check continuity between BOSE speaker amp harness connector and ground.

(+)		(-)	Continuity
Connector	Terminal		
B122	47	Ground	Yes
	52		

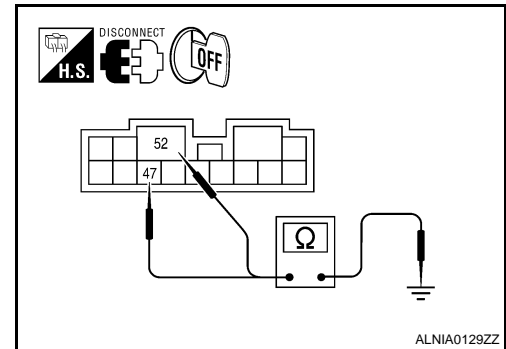

Does continuity exist?

YES >> INSPECTION END.

NO >> Repair harness or connector.

## SATELLITE RADIO TUNER

### SATELLITE RADIO TUNER : Diagnosis Procedure

INFOID:000000003188233

#### 1.CHECK FUSES

Check that the following fuses are not blown.

Unit	Terminals	Signal name	Fuse No.
Satellite radio tuner (factory installed)	32	Battery power	24
	36	Ignition switch ACC or ON	19

Are the fuses OK?

YES >> GO TO 2

NO >> If fuse is blown, be sure to eliminate cause of malfunction before installing new fuse.

#### 2.POWER SUPPLY CIRCUIT CHECK

1. Turn ignition switch OFF.
2. Disconnect satellite radio tuner (factory installed) connector B57.
3. Check voltage between the satellite radio tuner (factory installed) and ground.

A  
B  
C  
D  
E  
F  
G  
H  
I  
J  
K  
L  
M  
AV  
O  
P

# POWER SUPPLY AND GROUND CIRCUIT (COUPE)

< COMPONENT DIAGNOSIS >

[BOSE AUDIO WITHOUT NAVIGATION]

(+) Connector		Terminal	(-)	OFF	ACC	ON
B57	32			Ground	Battery voltage	Battery voltage
	36	Ground	0V	Battery voltage	Battery voltage	

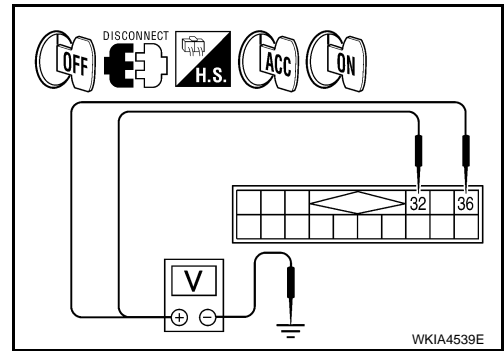

Are the voltage results as specified?

- YES >> GO TO 3
- NO >> • Check connector housings for disconnected or loose terminals.
- Repair harness or connector.

## 3. GROUND CIRCUIT CHECK

Inspect satellite radio tuner (factory installed) case ground.

Does case ground pass inspection?

- YES >> Inspection End.
- NO >> Repair satellite radio tuner (factory installed) case ground.

## BLUETOOTH CONTROL UNIT

### BLUETOOTH CONTROL UNIT : Diagnosis Procedure

INFOID:000000001830613

## 1. CHECK FUSE

Check that the following fuses of the Bluetooth control unit are not blown.

Power source	Fuse No.
Battery	24
Ignition switch ACC or ON	19
Ignition switch ON or START	3

Are the fuses OK?

- YES >> GO TO 2
- NO >> Be sure to eliminate cause of malfunction before installing new fuse.

## 2. CHECK POWER SUPPLY CIRCUIT

Check voltage between Bluetooth control unit harness connector and ground.

(+) Connector		Terminal	(-)	Ignition switch position	Value (Approx.)
B55	1			Ground	OFF
	2	ACC			
	3	ON			

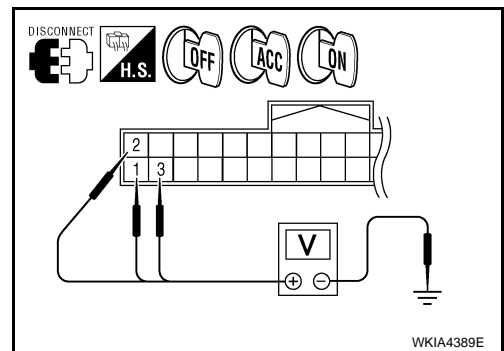

Are the voltage results as specified?

- YES >> GO TO 3
- NO >> Check harness between Bluetooth control unit and fuse.

## 3. CHECK GROUND CIRCUIT

# POWER SUPPLY AND GROUND CIRCUIT (COUPE)

[BOSE AUDIO WITHOUT NAVIGATION]

## < COMPONENT DIAGNOSIS >

1. Turn ignition switch OFF.
2. Disconnect Bluetooth control unit connector B55.
3. Check continuity between Bluetooth control unit harness connector and ground.

(+)		(-)	Continuity
Connector	Terminal		
B55	4	Ground	Yes
	24		

Does continuity exist?

- YES >> Inspection End.  
 NO >> Repair harness or connector.

## MICROPHONE

### MICROPHONE : Diagnosis Procedure

INFOID:000000003188238

#### 1.CHECK POWER SUPPLY CIRCUIT (MICROPHONE SIDE)

Check voltage between microphone harness connector and ground.

(+)		(-)	Ignition switch position	Value (Approx.)
Connector	Terminal			
R7	4	Ground	ON	5V

Is proper voltage present?

- YES >> GO TO 4  
 NO >> GO TO 2

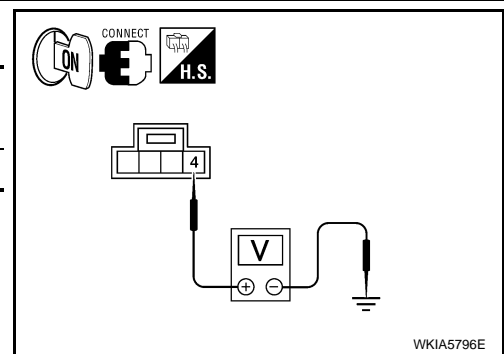
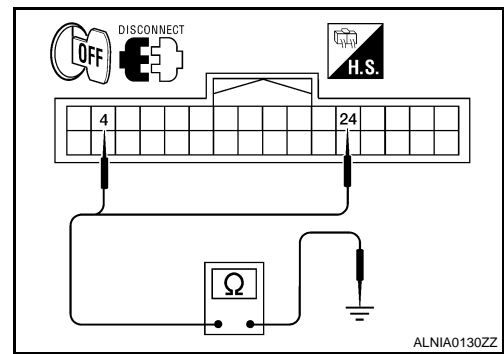

#### 2.CHECK POWER SUPPLY CIRCUIT (CONTINUITY)

1. Turn ignition switch OFF.
2. Disconnect Bluetooth control unit and microphone connectors.
3. Check continuity between microphone harness connector R7 (A) terminal 4 and Bluetooth control unit harness connector B55 (B) terminal 29.

Signal name	Continuity
Microphone VCC signal	Continuity should exist.

4. Check continuity between microphone harness connector R7 (A) terminal 4 and ground.

Signal name	Continuity
Microphone VCC signal	Continuity should not exist.

Are continuity results as specified?

- YES >> GO TO 3  
 NO >> Repair harness or connector.

#### 3.CHECK POWER SUPPLY CIRCUIT (BLUETOOTH CONTROL UNIT SIDE)

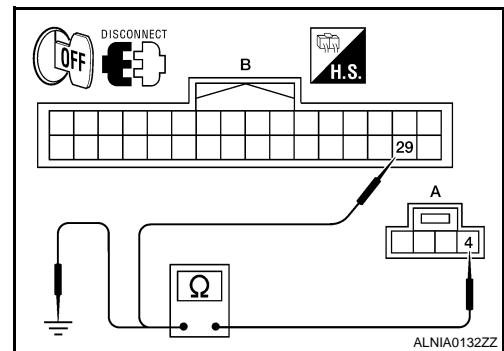

A  
B  
C  
D  
E  
F  
G  
H  
I  
J  
K  
L  
M  
N  
O  
P

AV

# POWER SUPPLY AND GROUND CIRCUIT (COUPE)

[BOSE AUDIO WITHOUT NAVIGATION]

## < COMPONENT DIAGNOSIS >

1. Connect Bluetooth control unit connector.
2. Turn ignition switch ON.
3. Check voltage between Bluetooth control unit harness connector and ground.

(+)		(-)	Ignition switch position	Value (Approx.)
Connector	Terminal			
B55	29	Ground	ON	5V

Is proper voltage present?

- YES >> Inspection End.  
 NO >> Replace Bluetooth control unit. Refer to [AV-227](#).  
["Removal and Installation - Coupe"](#).

## 4. CHECK GROUND CIRCUIT

1. Turn ignition switch OFF.
2. Disconnect Bluetooth control unit and microphone connectors.
3. Check continuity between microphone harness connector R7 terminal 2 and Bluetooth control unit harness connector B126 terminal 8.

Signal name	Continuity
Microphone ground	Continuity should exist.

Is continuity present?

- YES >> Inspection End.  
 NO >> Repair harness or connector.

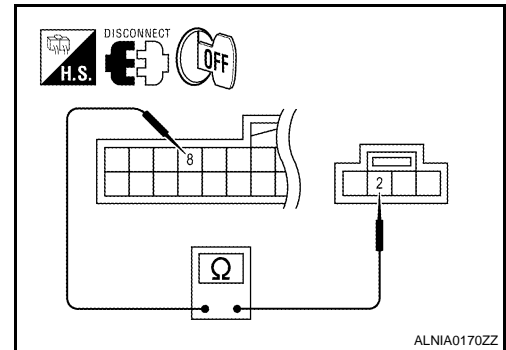
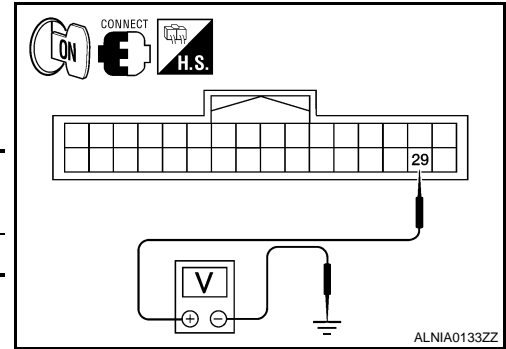

# POWER SUPPLY AND GROUND CIRCUIT (SEDAN)

< COMPONENT DIAGNOSIS >

[BOSE AUDIO WITHOUT NAVIGATION]

## POWER SUPPLY AND GROUND CIRCUIT (SEDAN)

### AUDIO UNIT

#### AUDIO UNIT : Diagnosis Procedure

INFOID:000000003222162

#### 1.CHECK FUSES

Check that the following fuses are not blown.

Unit	Terminals	Signal name	Fuse No.
Audio unit	19	Battery power	24
	7	Ignition switch ACC or ON	19

Are the fuses OK?

YES >> GO TO 2

NO >> If fuse is blown, be sure to eliminate cause of malfunction before installing new fuse.

#### 2.POWER SUPPLY CIRCUIT CHECK

1. Disconnect audio unit connector M43.
2. Check voltage between the audio unit connector M43 and ground.

(+)		(-)	OFF	ACC	ON
Connector	Terminal				
M43	19	Ground	Battery voltage	Battery voltage	Battery voltage
	7	Ground	0V	Battery voltage	Battery voltage

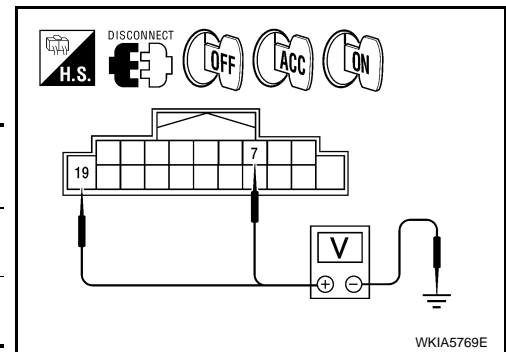

Are the voltage results as specified?

YES >> GO TO 3

NO >> • Check connector housings for disconnected or loose terminals.  
• Repair harness or connector.

#### 3.GROUND CIRCUIT CHECK

Inspect audio unit case ground.

Does case ground pass inspection?

YES >> Inspection End.

NO >> Repair audio unit case ground.

### BOSE SPEAKER AMP

#### BOSE SPEAKER AMP : Diagnosis Procedure

INFOID:000000003222163

#### 1.CHECK FUSE

Check for blown fuses.

Unit	Terminals	Signal name	Fuse No.
BOSE speaker amp.	50	Battery power	25
	51		26

Are the fuses OK?

YES >> GO TO 2

NO >> Be sure to eliminate cause of malfunction before installing new fuse.

#### 2.CHECK POWER SUPPLY CIRCUIT

A  
B  
C  
D  
E  
F  
G  
H  
I  
J  
K  
L  
M  
O  
P

AV

# POWER SUPPLY AND GROUND CIRCUIT (SEDAN)

[BOSE AUDIO WITHOUT NAVIGATION]

## < COMPONENT DIAGNOSIS >

1. Turn ignition switch OFF.
2. Disconnect BOSE speaker amp connector.
3. Check voltage between BOSE speaker amp harness connector and ground.

(+)		(-)	Voltage (approx.)
Connector	Terminal		
B122	50	Ground	Battery voltage
	51		

Is battery voltage present?

- YES >> GO TO 3  
 NO >> Check harness between BOSE speaker amp and fuse.

### 3.CHECK GROUND CIRCUIT

1. Turn ignition switch OFF.
2. Disconnect BOSE speaker amp connector.
3. Check continuity between BOSE speaker amp harness connector and ground.

(+)		(-)	Continuity
Connector	Terminal		
B122	47	Ground	Yes
	52		

Does continuity exist?

- YES >> INSPECTION END.  
 NO >> Repair harness or connector.

## SATELLITE RADIO TUNER

### SATELLITE RADIO TUNER : Diagnosis Procedure

INFOID:000000003222166

### 1.CHECK FUSES

Check that the following fuses are not blown.

Unit	Terminals	Signal name	Fuse No.
Satellite radio tuner (factory installed)	32	Battery power	24
	36	Ignition switch ACC or ON	19

Are the fuses OK?

- YES >> GO TO 2  
 NO >> If fuse is blown, be sure to eliminate cause of malfunction before installing new fuse.

### 2.POWER SUPPLY CIRCUIT CHECK

1. Turn ignition switch OFF.
2. Disconnect satellite radio tuner (factory installed) connector B123.
3. Check voltage between the satellite radio tuner (factory installed) and ground.

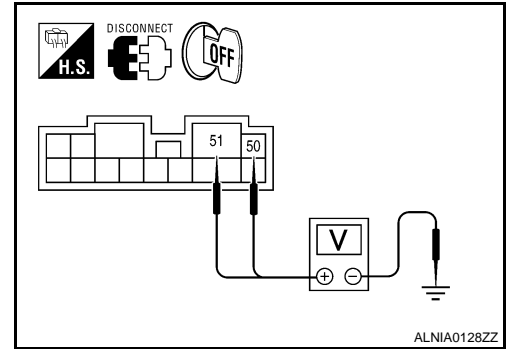

ALNIA0128ZZ

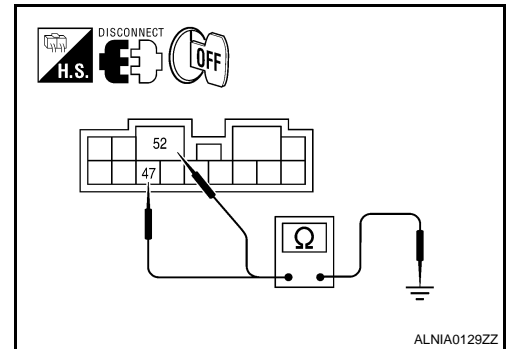

ALNIA0129ZZ

# POWER SUPPLY AND GROUND CIRCUIT (SEDAN)

< COMPONENT DIAGNOSIS >

[BOSE AUDIO WITHOUT NAVIGATION]

(+)		(-)	OFF	ACC	ON
Connector	Terminal				
B123	32	Ground	Battery voltage	Battery voltage	Battery voltage
	36	Ground	0V	Battery voltage	Battery voltage

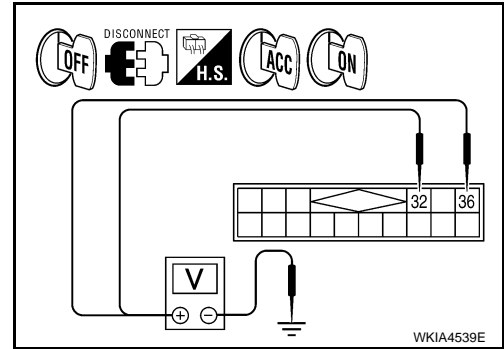

Are the voltage results as specified?

YES >> GO TO 3

NO >> • Check connector housings for disconnected or loose terminals.  
• Repair harness or connector.

## 3. GROUND CIRCUIT CHECK

Inspect satellite radio tuner (factory installed) case ground.

Does case ground pass inspection?

YES >> Inspection End.

NO >> Repair satellite radio tuner (factory installed) case ground.

## BLUETOOTH CONTROL UNIT

### BLUETOOTH CONTROL UNIT : Diagnosis Procedure

INFOID:000000003222169

## 1. CHECK FUSE

Check that the following fuses of the Bluetooth control unit are not blown.

Power source	Fuse No.
Battery	24
Ignition switch ACC or ON	19
Ignition switch ON or START	3

Are the fuses OK?

YES >> GO TO 2

NO >> Be sure to eliminate cause of malfunction before installing new fuse.

## 2. CHECK POWER SUPPLY CIRCUIT

Check voltage between Bluetooth control unit harness connector and ground.

(+)		(-)	Ignition switch position	Value (Approx.)
Connector	Terminal			
B126	1	Ground	OFF	Battery voltage
	2		ACC	
	3		ON	

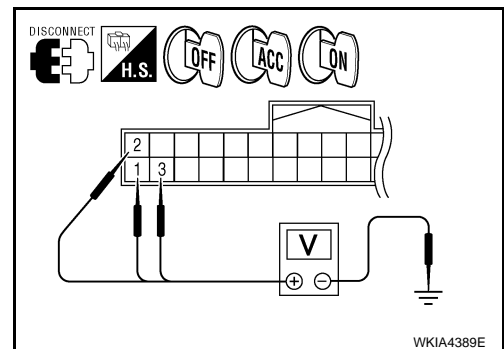

Are the voltage results as specified?

YES >> GO TO 3

NO >> Check harness between Bluetooth control unit and fuse.

## 3. CHECK GROUND CIRCUIT

# POWER SUPPLY AND GROUND CIRCUIT (SEDAN)

[BOSE AUDIO WITHOUT NAVIGATION]

## < COMPONENT DIAGNOSIS >

1. Turn ignition switch OFF.
2. Disconnect Bluetooth control unit connector B126.
3. Check continuity between Bluetooth control unit harness connector and ground.

(+)		(-)	Continuity
Connector	Terminal		
B126	4	Ground	Yes
	24		

Does continuity exist?

- YES >> Inspection End.  
 NO >> Repair harness or connector.

## MICROPHONE

### MICROPHONE : Diagnosis Procedure

INFOID:000000003222171

#### 1.CHECK POWER SUPPLY CIRCUIT (MICROPHONE SIDE)

Check voltage between microphone harness connector and ground.

(+)		(-)	Ignition switch position	Value (Approx.)
Connector	Terminal			
R7	4	Ground	ON	5V

Is proper voltage present?

- YES >> GO TO 4  
 NO >> GO TO 2

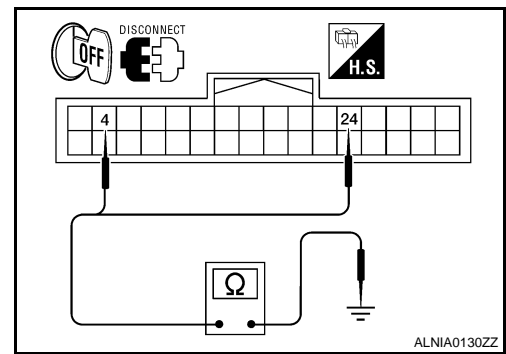

ALNIA0130ZZ

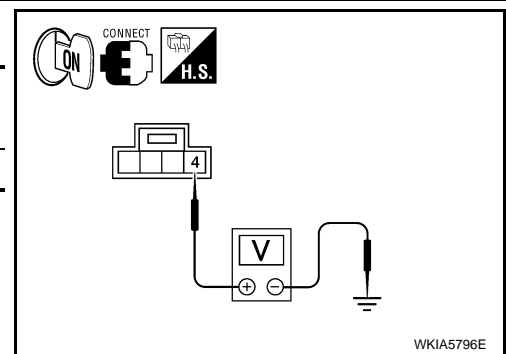

WKIA5796E

#### 2.CHECK POWER SUPPLY CIRCUIT (CONTINUITY)

1. Turn ignition switch OFF.
2. Disconnect Bluetooth control unit and microphone connectors.
3. Check continuity between microphone harness connector R7 (A) terminal 4 and Bluetooth control unit harness connector B126 (B) terminal 29.

Signal name	Continuity
Microphone VCC signal	Continuity should exist.

4. Check continuity between microphone harness connector R7 (A) terminal 4 and ground.

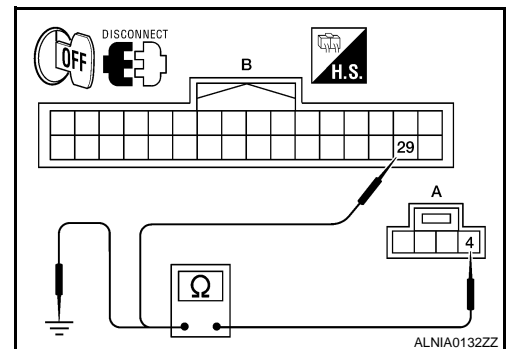

ALNIA0132ZZ

Signal name	Continuity
Microphone VCC signal	Continuity should not exist.

Are continuity results as specified?

- YES >> GO TO 3  
 NO >> Repair harness or connector.

#### 3.CHECK POWER SUPPLY CIRCUIT (BLUETOOTH CONTROL UNIT SIDE)



# POWER SUPPLY AND GROUND CIRCUIT (SEDAN)

[BOSE AUDIO WITHOUT NAVIGATION]

## < COMPONENT DIAGNOSIS >

1. Connect Bluetooth control unit connector.
2. Turn ignition switch ON.
3. Check voltage between Bluetooth control unit harness connector and ground.

(+)		(-)	Ignition switch position	Value (Approx.)
Connector	Terminal			
B126	29	Ground	ON	5V

Is proper voltage present?

- YES >> Inspection End.  
 NO >> Replace Bluetooth control unit. Refer to [AV-227](#).  
["Removal and Installation - Sedan"](#).

### 4.CHECK GROUND CIRCUIT

1. Turn ignition switch OFF.
2. Disconnect Bluetooth control unit and microphone connectors.
3. Check continuity between microphone harness connector R7 terminal 2 and Bluetooth control unit harness connector B126 terminal 8.

Signal name	Continuity
Microphone ground	Continuity should exist.

Is continuity present?

- YES >> Inspection End.  
 NO >> Repair harness or connector.

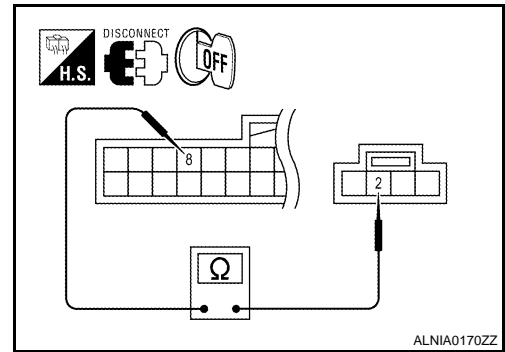
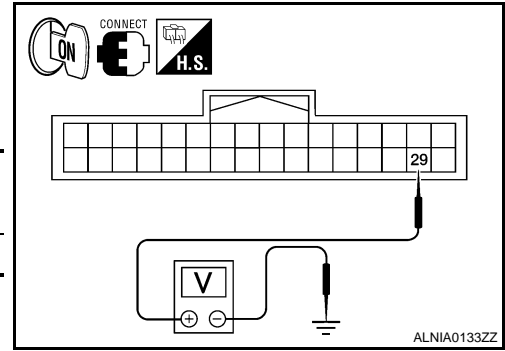

A  
B  
C  
D  
E  
F  
G  
H  
I  
J  
K  
L  
M  
O  
P

AV

# DOOR SPEAKER (COUPE)

[BOSE AUDIO WITHOUT NAVIGATION]

< COMPONENT DIAGNOSIS >

## DOOR SPEAKER (COUPE)

### Description

INFOID:000000001830615

The audio unit sends audio signals to the BOSE speaker amp. The BOSE speaker amp. amplifies the audio signals before sending them to the door speakers using the audio signal circuits.

### Diagnosis Procedure

INFOID:000000001830616

#### 1. HARNESS CHECK

1. Disconnect BOSE speaker amp. connector B121 and suspect speaker connector.
2. Check continuity between BOSE speaker amp. harness connector B121 (A) and suspect speaker harness connector (B).

A		B		Continuity
Connector	Terminal	Connector	Terminal	
B121	58	D3	1	Yes
	59		2	
	71	D103	1	
	72		2	

3. Check continuity between BOSE speaker amp. harness connector B121 (A) and ground.

A		B	Continuity
Connector	Terminal		
B121	58	Ground	No
	59		
	71		
	72		

Are continuity test results as specified?

YES >> GO TO 2

- NO >> • Check connector housings for disconnected or loose terminals.  
• Repair harness or connector.

#### 2. DOOR SPEAKER SIGNAL CHECK

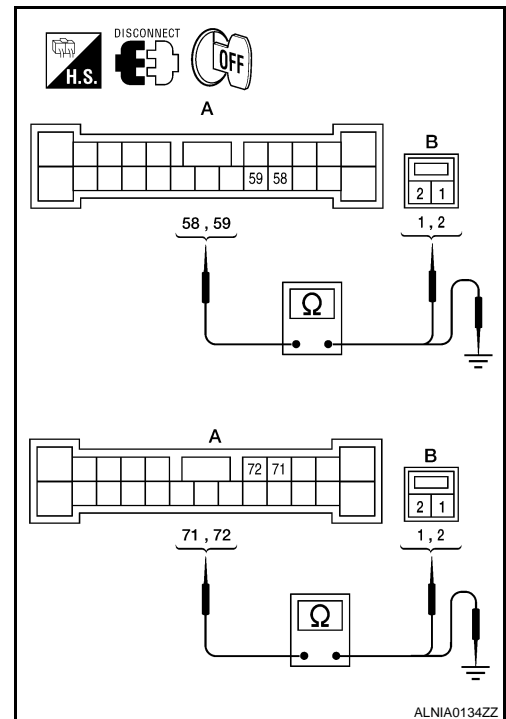

ALNIA0134ZZ

# DOOR SPEAKER (COUPE)

[BOSE AUDIO WITHOUT NAVIGATION]

## < COMPONENT DIAGNOSIS >

1. Connect BOSE speaker amp. connector B121 and suspect speaker connector.
2. Turn ignition switch to ACC.
3. Push "POWER" switch.
4. Check the signal between BOSE speaker amp. harness connector B121 terminals with CONSULT-III or oscilloscope.

Connector	Terminal		Condition	Reference signal
	(+)	(-)		
B121	58	59	Receive audio signal	
	71	72		

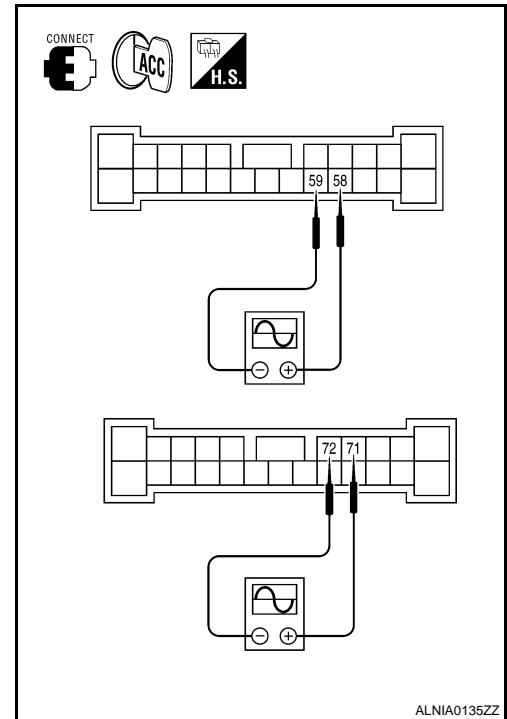

Is audio signal voltage as specified?

YES >> Replace suspect speaker. Refer to [AV-209. "Removal and Installation"](#).

NO >> GO TO 3

## 3. HARNESS CHECK

1. Disconnect audio unit connector M43 and BOSE speaker amp. connector B121.
2. Check continuity between audio unit harness connector M43 (A) and BOSE speaker amp. harness connector B121 (B).

A		B		Continuity
Connector	Terminal	Connector	Terminal	
M43	2	B121	75	Yes
	3		76	
	11		73	
	12		74	

3. Check continuity between audio unit harness connector M43 (A) and ground.

A		—	Continuity
Connector	Terminal		
M43	2	Ground	No
	3		
	11		
	12		

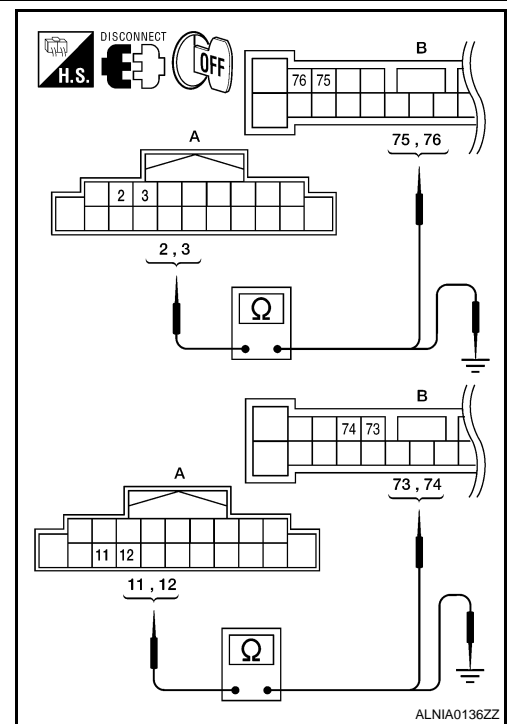

Are continuity test results as specified?

YES >> GO TO 4

NO >> • Check connector housings for disconnected or loose terminals.  
• Repair harness or connector.

## 4. DOOR SPEAKER SIGNAL CHECK

A  
B  
C  
D  
E  
F  
G  
H  
I  
J  
K  
L  
M  
O  
P

# DOOR SPEAKER (COUPE)

[BOSE AUDIO WITHOUT NAVIGATION]

< COMPONENT DIAGNOSIS >

1. Connect audio unit connector and BOSE speaker amp. connector.
2. Turn ignition switch ACC.
3. Push "POWER" switch.
4. Check the signal between audio unit harness connector terminals with CONSULT-III or oscilloscope.

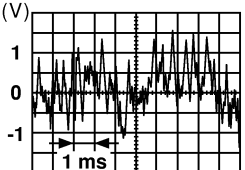
Connector	Terminals		Condition	Reference signal
	(+)	(-)		
M43	2	3	Receive audio signal	
	11	12		

SKIA0177E

Are the audio signal voltage readings as specified?

- YES >> Replace BOSE speaker amp. Refer to [AV-205, "Removal and Installation - Coupe"](#).
- NO >> Replace audio unit. Refer to [AV-204, "Removal and Installation"](#).

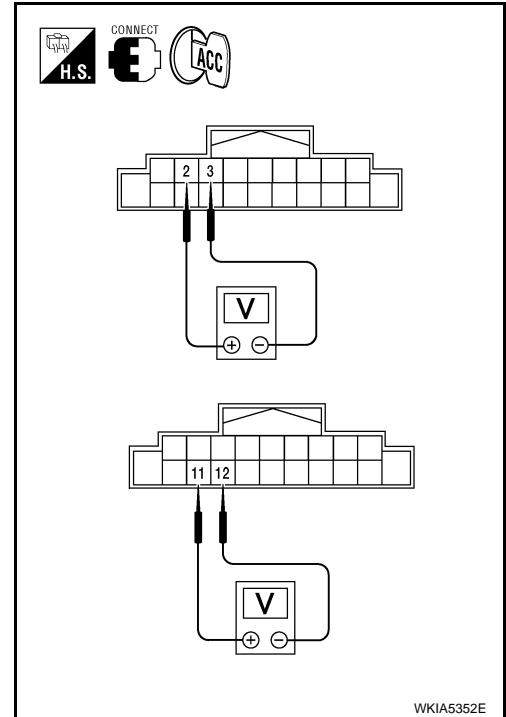

# FRONT DOOR SPEAKER (SEDAN)

< COMPONENT DIAGNOSIS >

[BOSE AUDIO WITHOUT NAVIGATION]

## FRONT DOOR SPEAKER (SEDAN)

### Description

INFOID:000000003188239

The audio unit sends audio signals to the BOSE speaker amp. The BOSE speaker amp. amplifies the audio signals before sending them to the front door speakers using the audio signal circuits.

### Diagnosis Procedure

INFOID:000000003188240

#### 1. HARNESS CHECK

1. Disconnect BOSE speaker amp. connector B121 and suspect speaker connector.
2. Check continuity between BOSE speaker amp. harness connector B121 (A) and suspect speaker harness connector (B).

A		B		Continuity
Connector	Terminal	Connector	Terminal	
B121	58	D3	1	Yes
	59		2	
	71	D103	1	
	72		2	

3. Check continuity between BOSE speaker amp. harness connector B121 (A) and ground.

A		B	Continuity
Connector	Terminal		
B121	58	Ground	No
	59		
	71		
	72		

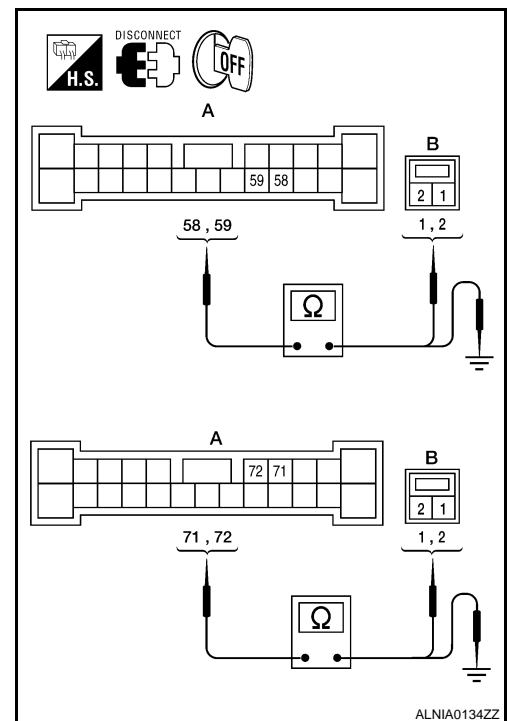

ALNIA0134ZZ

Are continuity test results as specified?

YES >> GO TO 2

- NO >> • Check connector housings for disconnected or loose terminals.  
• Repair harness or connector.

#### 2. FRONT DOOR SPEAKER SIGNAL CHECK

A  
B  
C  
D  
E  
F  
G  
H  
I  
J  
K  
L  
M  
AV  
O  
P

# FRONT DOOR SPEAKER (SEDAN)

[BOSE AUDIO WITHOUT NAVIGATION]

## < COMPONENT DIAGNOSIS >

1. Connect BOSE speaker amp. connector B121 and suspect speaker connector.
2. Turn ignition switch to ACC.
3. Push "POWER" switch.
4. Check the signal between BOSE speaker amp. harness connector B121 terminals with CONSULT-III or oscilloscope.

Connector	Terminal		Condition	Reference signal
	(+)	(-)		
B121	58	59	Receive audio signal	
	71	72		

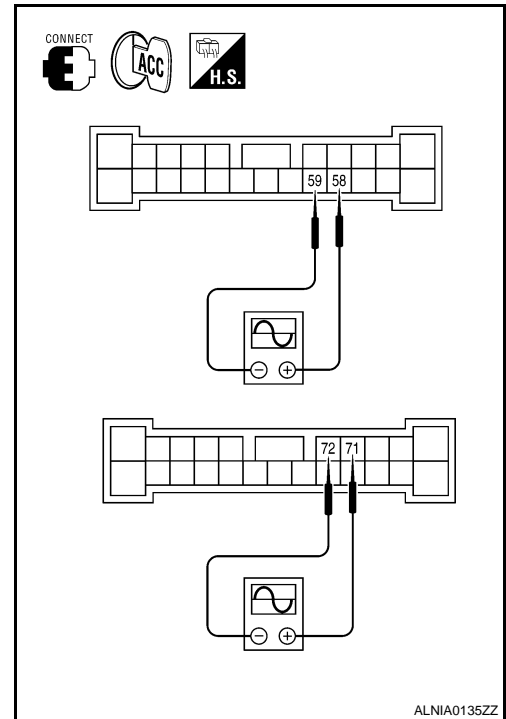

Is audio signal voltage as specified?

YES >> Replace suspect speaker. Refer to [AV-209. "Removal and Installation"](#).

NO >> GO TO 3

### 3. HARNESS CHECK

1. Disconnect audio unit connector M43 and BOSE speaker amp. connector B121.
2. Check continuity between audio unit harness connector M43 (A) and BOSE speaker amp. harness connector B121 (B).

A		B		Continuity
Connector	Terminal	Connector	Terminal	
M43	2	B121	75	Yes
	3		76	
	11		73	
	12		74	

3. Check continuity between audio unit harness connector M43 (A) and ground.

A		—	Continuity
Connector	Terminal		
M43	2	Ground	No
	3		
	11		
	12		

Are continuity test results as specified?

YES >> GO TO 4

NO >> • Check connector housings for disconnected or loose terminals.  
• Repair harness or connector.

### 4. FRONT DOOR SPEAKER SIGNAL CHECK

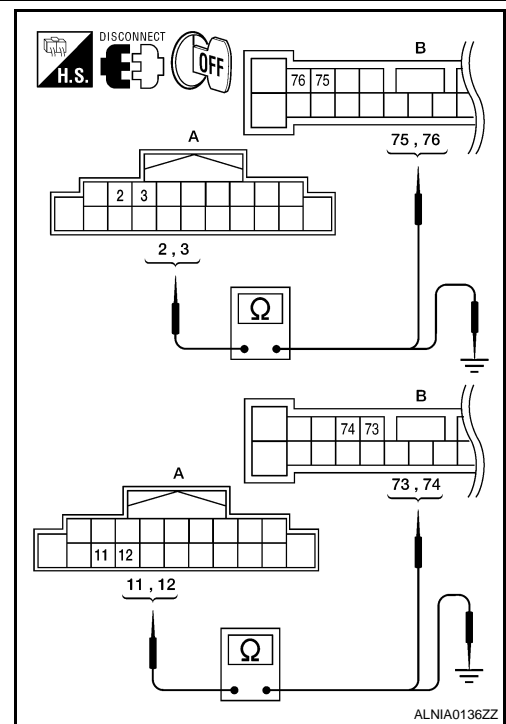

# FRONT DOOR SPEAKER (SEDAN)

[BOSE AUDIO WITHOUT NAVIGATION]

## < COMPONENT DIAGNOSIS >

1. Connect audio unit connector and BOSE speaker amp. connector.
2. Turn ignition switch ACC.
3. Push "POWER" switch.
4. Check the signal between audio unit harness connector terminals with CONSULT-III or oscilloscope.

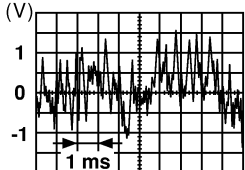
Connector	Terminals		Condition	Reference signal
	(+)	(-)		
M43	2	3	Receive audio signal	
	11	12		

SKIA0177E

Are the audio signal voltage readings as specified?

- YES >> Replace BOSE speaker amp. Refer to [AV-205, "Removal and Installation - Coupe"](#).
- NO >> Replace audio unit. Refer to [AV-204, "Removal and Installation"](#).

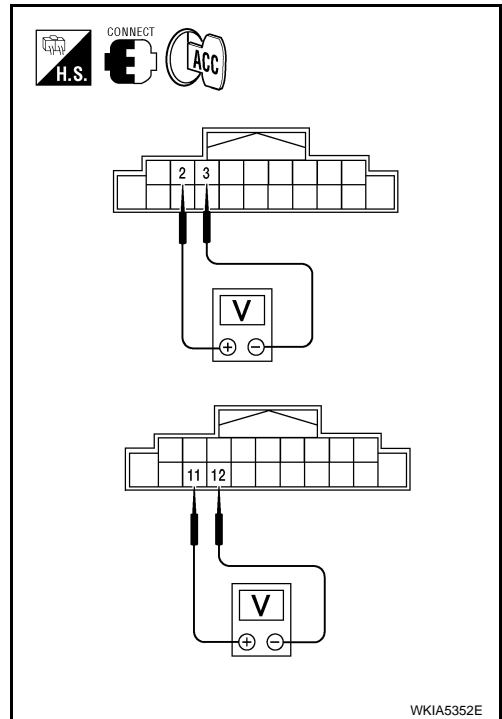

A  
B  
C  
D  
E  
F  
G  
H  
I  
J  
K  
L  
M  
O  
P

AV

# FRONT TWEETER (COUPE)

[BOSE AUDIO WITHOUT NAVIGATION]

< COMPONENT DIAGNOSIS >

## FRONT TWEETER (COUPE)

### Description

INFOID:000000001830617

The audio unit sends audio signals to the BOSE speaker amp. The BOSE speaker amp. amplifies the audio signals before sending them to the front tweeters using the audio signal circuits.

### Diagnosis Procedure

INFOID:000000001830618

#### 1. HARNESS CHECK

1. Disconnect BOSE speaker amp. connector B122 and suspect tweeter connector.
2. Check continuity between BOSE speaker amp. harness connector B122 (A) and suspect tweeter harness connector (B).

A		B		Continuity
Connector	Terminal	Connector	Terminal	
B122	41	M51	1	Yes
	42		2	
	44	M52	1	
	43		2	

3. Check continuity between BOSE speaker amp. harness connector B122 (A) and ground.

A		—	Continuity
Connector	Terminal		
B122	41	Ground	No
	42		
	44		
	43		

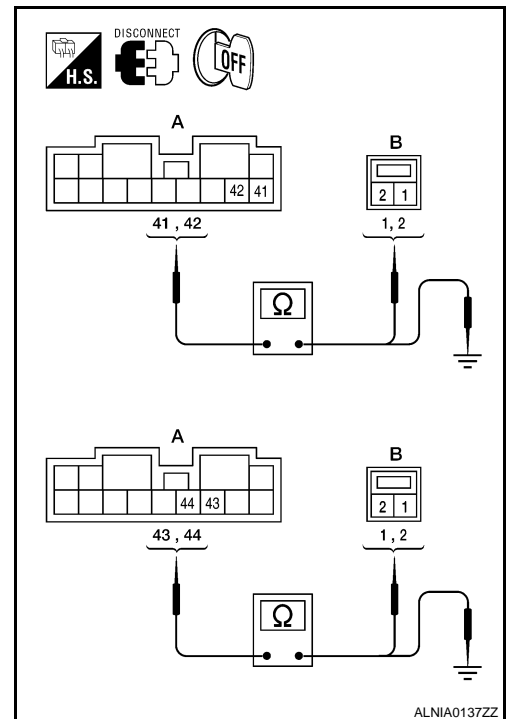

Are continuity test results as specified?

- YES >> GO TO 2  
 NO >> • Check connector housings for disconnected or loose terminals.  
 • Repair harness or connector.

#### 2. FRONT TWEETER SIGNAL CHECK



# FRONT TWEETER (COUPE)

[BOSE AUDIO WITHOUT NAVIGATION]

## < COMPONENT DIAGNOSIS >

1. Connect BOSE speaker amp. connector B122 and suspect tweeter connector.
2. Turn ignition switch to ACC.
3. Push "POWER" switch.
4. Check the signal between BOSE speaker amp. harness connector B122 terminals with CONSULT-III or oscilloscope.

Connector	Terminals		Condition	Reference signal
	(+)	(-)		
B122	41	42	Receive audio signal	
	44	43		

SKIA0177E

Are the audio signal voltage readings as specified?

YES >> Replace suspect tweeter. Refer to [AV-207, "Removal and Installation"](#).

NO >> GO TO 3

### 3. HARNESS CHECK

1. Disconnect audio unit connector M43 and BOSE speaker amp. connector B121.
2. Check continuity between audio unit harness connector M43 (A) and BOSE speaker amp. harness connector B121 (B).

A		B		Continuity
Connector	Terminal	Connector	Terminal	
M43	2	B121	75	Yes
	3		76	
	11		73	
	12		74	

3. Check continuity between audio unit harness connector M43 (A) and ground.

A		—	Continuity
Connector	Terminal		
M43	2	Ground	No
	3		
	11		
	12		

Are continuity test results as specified?

YES >> GO TO 4

NO >> • Check connector housings for disconnected or loose terminals.  
• Repair harness or connector.

### 4. FRONT TWEETER SIGNAL CHECK

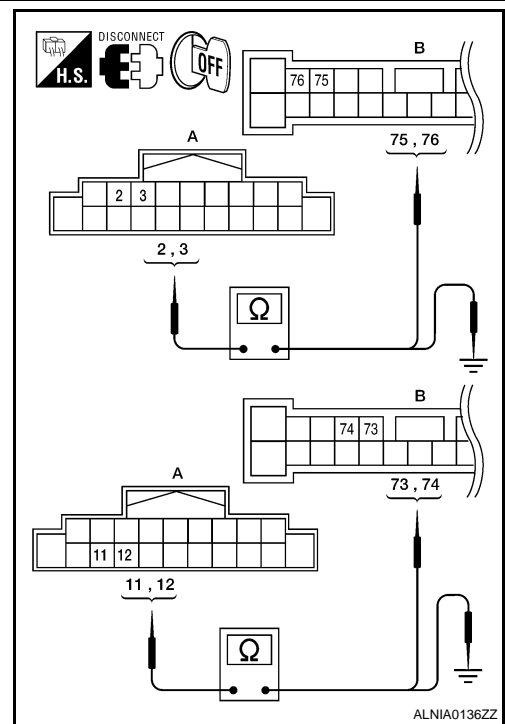
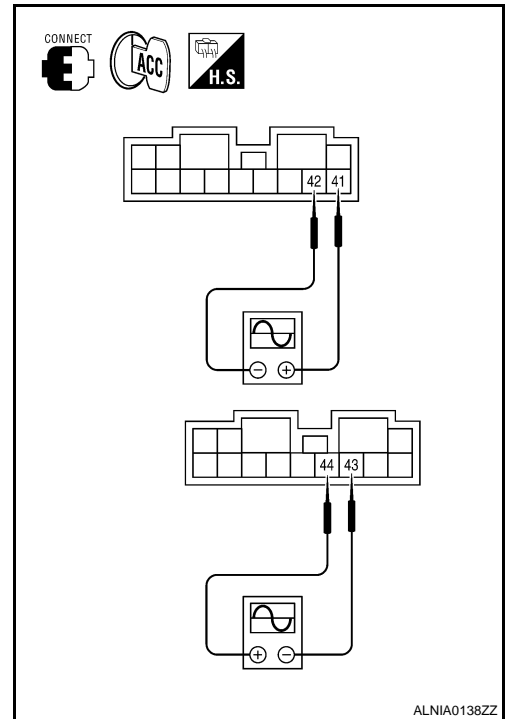

A  
B  
C  
D  
E  
F  
G  
H  
I  
J  
K  
L  
M  
O  
P

AV

# FRONT TWEETER (COUPE)

[BOSE AUDIO WITHOUT NAVIGATION]

## < COMPONENT DIAGNOSIS >

1. Connect audio unit connector and BOSE speaker amp. connector.
2. Turn ignition switch ACC.
3. Push "POWER" switch.
4. Check the signal between audio unit harness connector M43 terminals with CONSULT-III or oscilloscope.

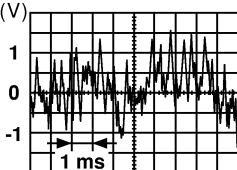
Connector	Terminals		Condition	Reference signal
	(+)	(-)		
M43	2	3	Receive audio signal	
	11	12		

SKIA0177E

Are the audio signal voltage readings as specified?

- YES >> Replace BOSE speaker amp. Refer to [AV-205, "Removal and Installation - Coupe"](#).
- NO >> Replace audio unit. Refer to [AV-204, "Removal and Installation"](#).

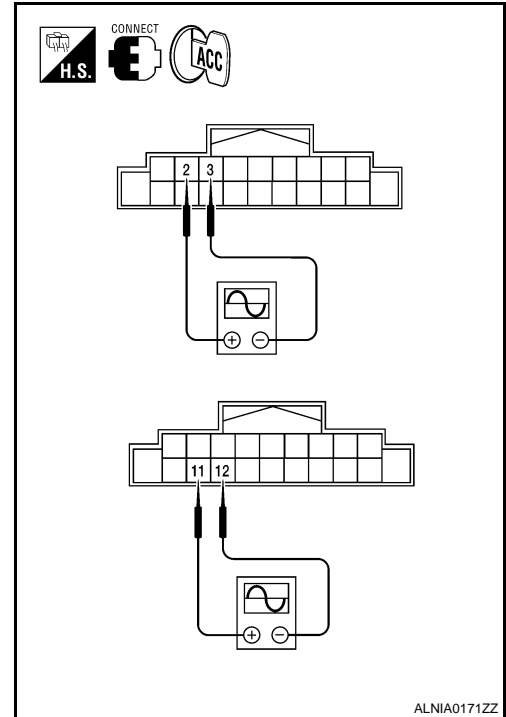

# TWEETER (SEDAN)

< COMPONENT DIAGNOSIS >

[BOSE AUDIO WITHOUT NAVIGATION]

## TWEETER (SEDAN)

### Description

INFOID:000000003188241

The audio unit sends audio signals to the BOSE speaker amp. The BOSE speaker amp. amplifies the audio signals before sending them to the front tweeters using the audio signal circuits.

### Diagnosis Procedure

INFOID:000000003188242

#### 1. HARNESS CHECK

1. Disconnect BOSE speaker amp. connector B122 and suspect tweeter connector.
2. Check continuity between BOSE speaker amp. harness connector B122 (A) and suspect tweeter harness connector (B).

A		B		Continuity
Connector	Terminal	Connector	Terminal	
B122	41	M51	1	Yes
	42		2	
	44	M52	1	
	43		2	

3. Check continuity between BOSE speaker amp. harness connector B122 (A) and ground.

A		—	Continuity
Connector	Terminal		
B122	41	Ground	No
	42		
	44		
	43		

Are continuity test results as specified?

YES >> GO TO 2

- NO >> • Check connector housings for disconnected or loose terminals.  
• Repair harness or connector.

#### 2. TWEETER SIGNAL CHECK

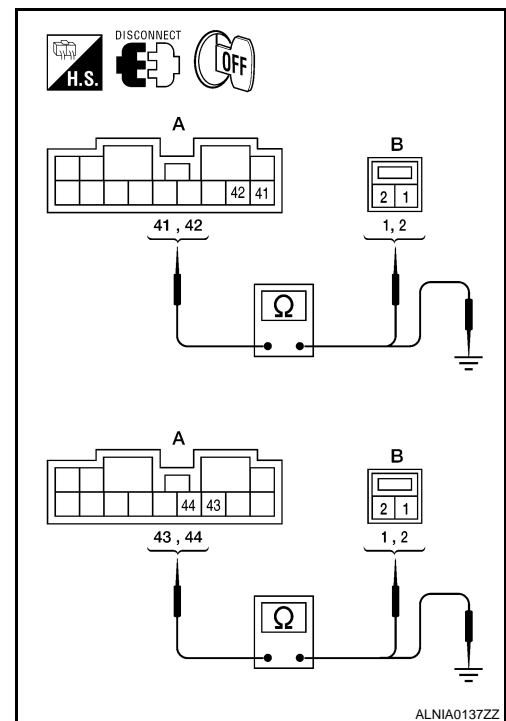

ALNIA0137ZZ

A  
B  
C  
D  
E  
F  
G  
H  
I  
J  
K  
L  
M

AV

O  
P

# TWEETER (SEDAN)

[BOSE AUDIO WITHOUT NAVIGATION]

## < COMPONENT DIAGNOSIS >

1. Connect BOSE speaker amp. connector B122 and suspect tweeter connector.
2. Turn ignition switch to ACC.
3. Push "POWER" switch.
4. Check the signal between BOSE speaker amp. harness connector B122 terminals with CONSULT-III or oscilloscope.

Connector	Terminals		Condition	Reference signal
	(+)	(-)		
B122	41	42	Receive audio signal	
	44	43		

SKIA0177E

Are the audio signal voltage readings as specified?

YES >> Replace suspect tweeter. Refer to [AV-207. "Removal and Installation"](#).

NO >> GO TO 3

### 3. HARNESS CHECK

1. Disconnect audio unit connector M43 and BOSE speaker amp. connector B121.
2. Check continuity between audio unit harness connector M43 (A) and BOSE speaker amp. harness connector B121 (B).

A		B		Continuity
Connector	Terminal	Connector	Terminal	
M43	2	B121	75	Yes
	3		76	
	11		73	
	12		74	

3. Check continuity between audio unit harness connector M43 (A) and ground.

A		—	Continuity
Connector	Terminal		
M43	2	Ground	No
	3		
	11		
	12		

Are continuity test results as specified?

YES >> GO TO 4

NO >> • Check connector housings for disconnected or loose terminals.  
• Repair harness or connector.

### 4. TWEETER SIGNAL CHECK

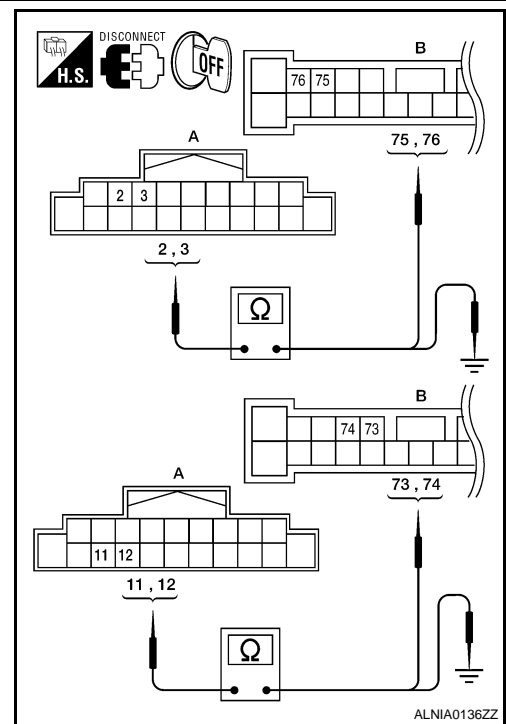
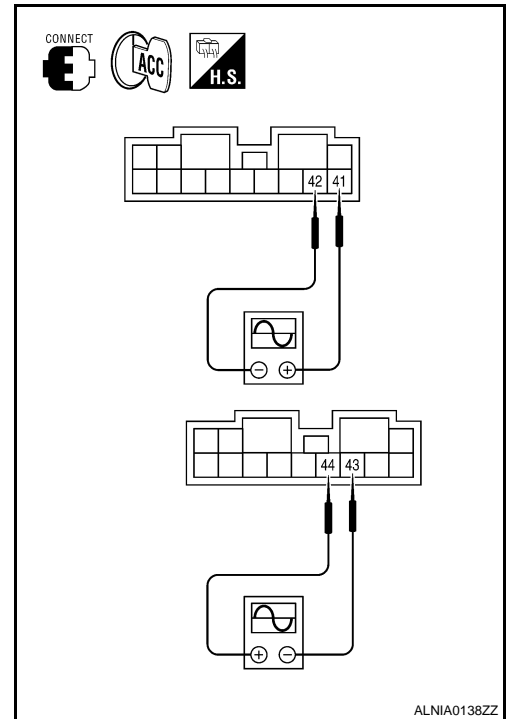

# TWEETER (SEDAN)

[BOSE AUDIO WITHOUT NAVIGATION]

## < COMPONENT DIAGNOSIS >

1. Connect audio unit connector and BOSE speaker amp. connector.
2. Turn ignition switch ACC.
3. Push "POWER" switch.
4. Check the signal between audio unit harness connector M43 terminals with CONSULT-III or oscilloscope.

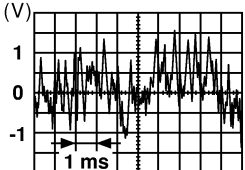
Connector	Terminals		Condition	Reference signal
	(+)	(-)		
M43	2	3	Receive audio signal	
	11	12		

SKIA0177E

Are the audio signal voltage readings as specified?

- YES >> Replace BOSE speaker amp. Refer to [AV-205, "Removal and Installation - Coupe"](#).
- NO >> Replace audio unit. Refer to [AV-204, "Removal and Installation"](#).

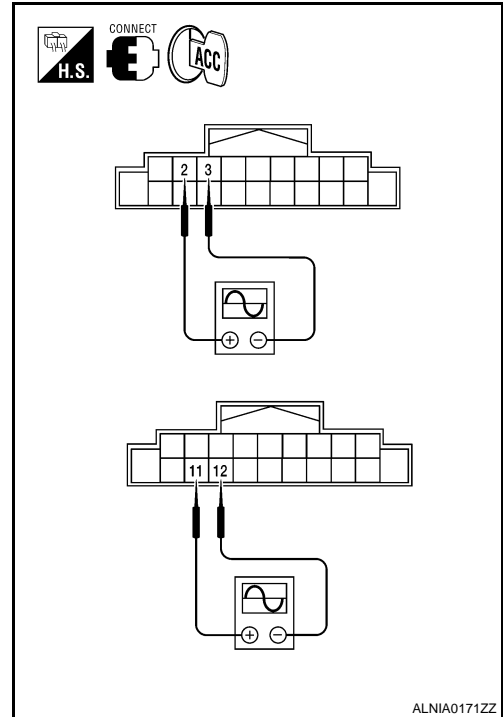

A  
B  
C  
D  
E  
F  
G  
H  
I  
J  
K  
L  
M  
O  
P

AV

# CENTER SPEAKER

< COMPONENT DIAGNOSIS >

[BOSE AUDIO WITHOUT NAVIGATION]

## CENTER SPEAKER

### Description

INFOID:000000001830619

The audio unit sends audio signals to the BOSE speaker amp. The BOSE speaker amp. amplifies the audio signals before sending them to the center speaker using the audio signal circuits.

### Diagnosis Procedure

INFOID:000000001830620

#### 1. HARNESS CHECK

1. Disconnect BOSE speaker amp. connector B121 and center speaker connector M151.
2. Check continuity between BOSE speaker amp. harness connector B121 (A) and center speaker harness connector M151 (B).

A		B		Continuity
Connector	Terminal	Connector	Terminal	
B121	69	M151	1	Yes
	70		2	

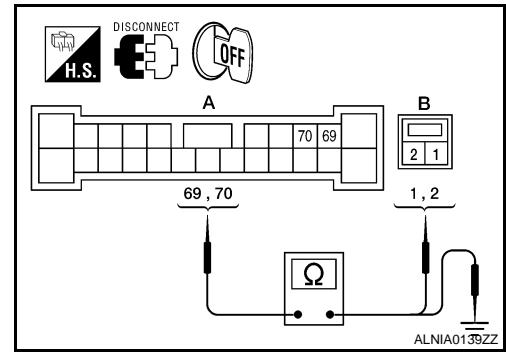

3. Check continuity between BOSE speaker amp. harness connector B121 (A) and ground.

A		—	Continuity
Connector	Terminal		
B121	69	Ground	No
	70		

Are continuity test results as specified?

YES >> GO TO 2

NO >> • Check connector housings for disconnected or loose terminals.  
• Repair harness or connector.

#### 2. CENTER SPEAKER SIGNAL CHECK

1. Connect BOSE speaker amp. connector B121 and center speaker connector.
2. Turn ignition switch to ACC.
3. Push "POWER" switch.
4. Check the signal between BOSE speaker amp. harness connector B121 terminals with CONSULT-III or oscilloscope.

Connector	Terminals		Condition	Reference signal
	(+)	(-)		
B121	69	70	Receive audio signal	<p>SKIA0177E</p>

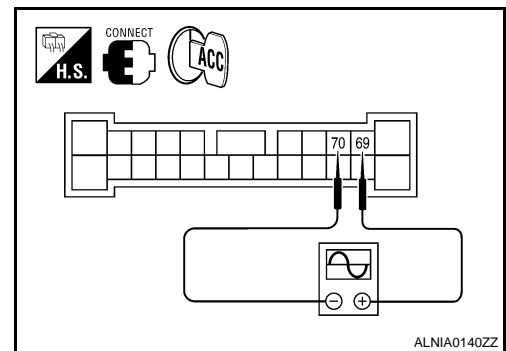

Is the audio signal voltage reading as specified?

YES >> Replace center speaker. Refer to [AV-208. "Removal and Installation"](#).

NO >> GO TO 3

#### 3. HARNESS CHECK

# CENTER SPEAKER

[BOSE AUDIO WITHOUT NAVIGATION]

## < COMPONENT DIAGNOSIS >

1. Disconnect audio unit connector M43 and BOSE speaker amp. connector B121.
2. Check continuity between audio unit harness connector M43 (A) and BOSE speaker amp. harness connector B121 (B).

A		B		Continuity
Connector	Terminal	Connector	Terminal	
M43	2	B121	75	Yes
	3		76	
	11		73	
	12		74	

3. Check continuity between audio unit harness connector M43 (A) and ground.

A		—	Continuity
Connector	Terminal		
M43	2	Ground	No
	3		
	11		
	12		

Are continuity test results as specified?

YES >> GO TO 4

- NO >> • Check connector housings for disconnected or loose terminals.  
• Repair harness or connector.

## 4. CENTER SPEAKER SIGNAL CHECK

1. Connect audio unit connector and BOSE speaker amp. connector.
2. Turn ignition switch ACC.
3. Push "POWER" switch.
4. Check the signal between audio unit harness connector M43 terminals with CONSULT-III or oscilloscope.

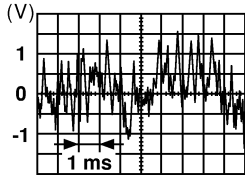
Connector	Terminals		Condition	Reference signal
	(+)	(-)		
M43	2	3	Receive audio signal	
	11	12		

Are the audio signal voltage readings as specified?

YES >> Replace BOSE speaker amp. Refer to [AV-205, "Removal and Installation - Coupe"](#).

NO >> Replace audio unit. Refer to [AV-204, "Removal and Installation"](#).

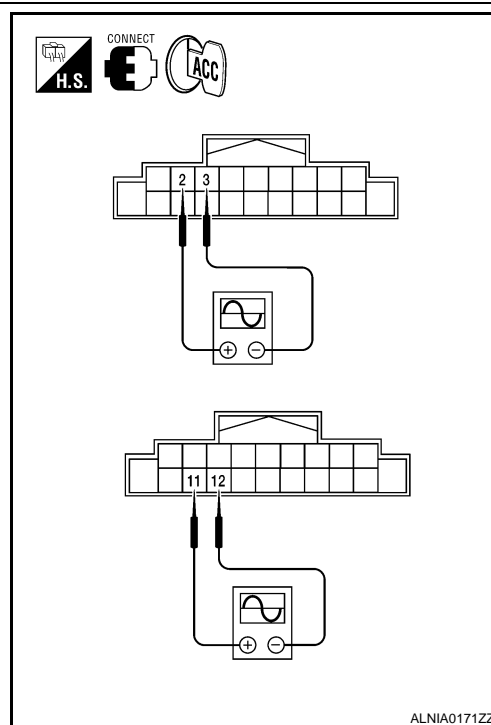
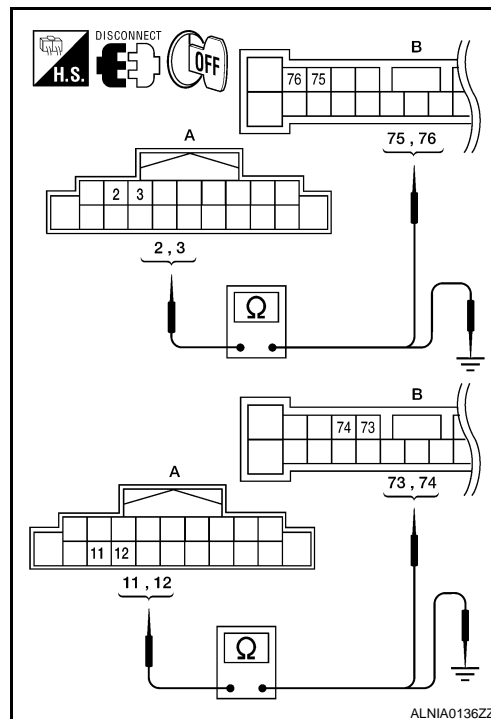

# REAR TWEETER (COUPE)

[BOSE AUDIO WITHOUT NAVIGATION]

< COMPONENT DIAGNOSIS >

## REAR TWEETER (COUPE)

### Description

INFOID:000000001830621

The audio unit sends audio signals to the BOSE speaker amp. The BOSE speaker amp. amplifies the audio signals before sending them to the rear tweeters using the audio signal circuits.

### Diagnosis Procedure

INFOID:000000001830622

#### 1. HARNESS CHECK

1. Disconnect BOSE speaker amp. connectors B121, B122 and suspect tweeter connector.
2. Check continuity between BOSE speaker amp. harness connectors B121 (A) and B122 (B) and suspect tweeter harness connector (C).

Connector	Terminal	Connector	Terminal	Continuity
A: B121	55	C: D202	2	Yes
	68		1	
B: B122	49	C: D302	2	
	54		1	

3. Check continuity between BOSE speaker amp. harness connectors B121 (A) and B122 (B) and ground.

Connector	Terminal	-	Continuity
A: B121	55	Ground	No
	68		
B: B122	49		
	54		

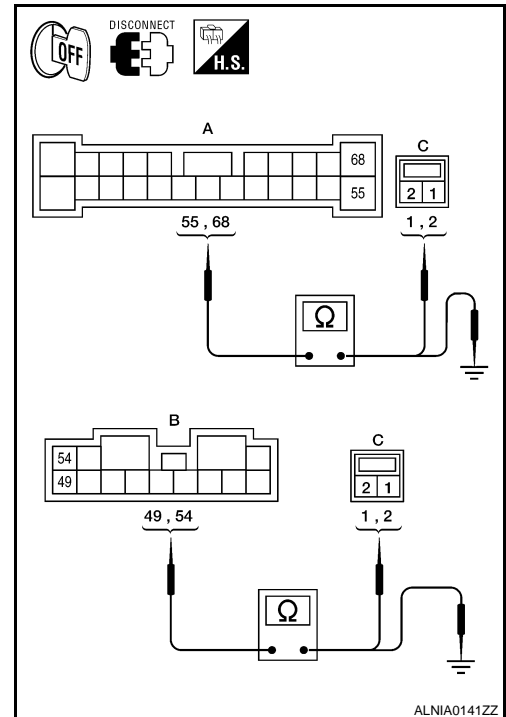

Are the continuity test results as specified?

YES >> GO TO 2

- NO >> • Check connector housings for disconnected or loose terminals.  
• Repair harness or connector.

#### 2. REAR DOOR SPEAKER SIGNAL CHECK



# REAR TWEETER (COUPE)

[BOSE AUDIO WITHOUT NAVIGATION]

## < COMPONENT DIAGNOSIS >

1. Connect BOSE speaker amp. connectors and suspect tweeter connector.
2. Turn ignition switch to ACC.
3. Push "POWER" switch.
4. Check the signal between BOSE speaker amp. harness connectors B121 (A) and B122 (B) terminals with CONSULT-III or oscilloscope.

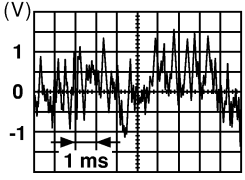
Connector	Terminals		Condition	Reference signal
	(+)	(-)		
A: B121	68	55	Receive audio signal	
B: B122	54	49		

SKIA0177E

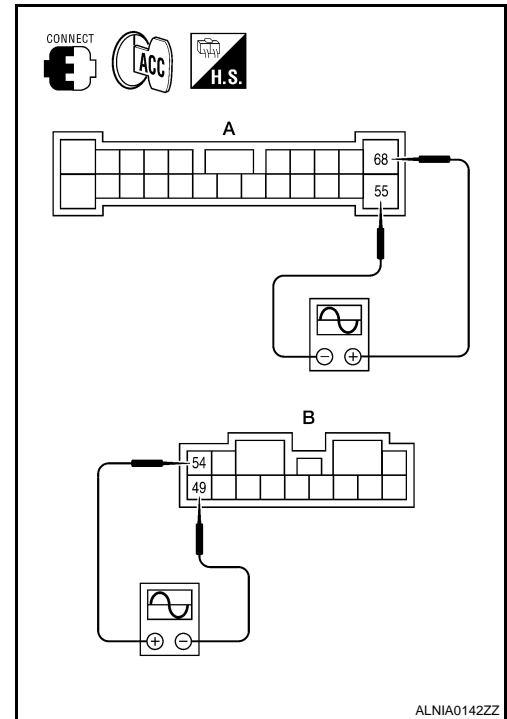

Are audio signal voltage readings as specified?

- YES >> Replace suspect tweeter. Refer to [AV-211, "Removal and Installation - Coupe"](#).
- NO >> GO TO 3

## 3. HARNESS CHECK

1. Disconnect audio unit connector M43 and BOSE speaker amp. connector B121.
2. Check continuity between audio unit harness connector M43 (A) and BOSE speaker amp. harness connector B121 (B).

A		B		Continuity
Connector	Terminal	Connector	Terminal	
M43	4	B121	64	Yes
	5		63	
	13		66	
	14		65	

3. Check continuity between audio unit harness connector M43 (A) and ground.

A		—	Continuity
Connector	Terminal		
M43	4	Ground	No
	5		
	13		
	14		

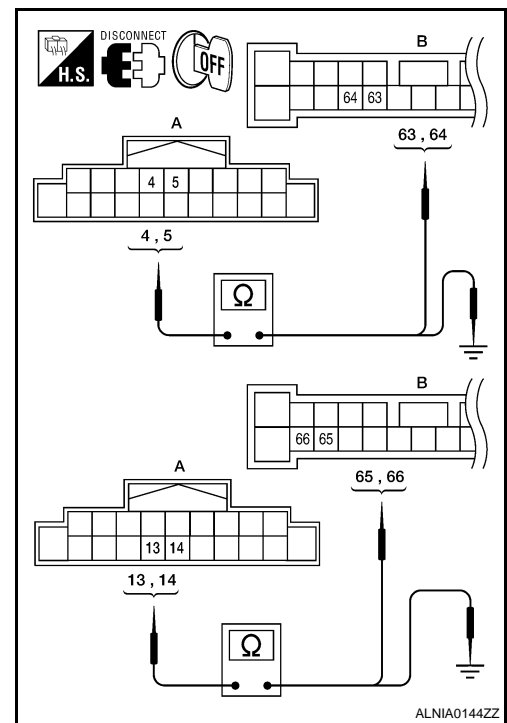

Are the continuity test results as specified?

- YES >> GO TO 4
- NO >> • Check connector housings for disconnected or loose terminals.  
• Repair harness or connector.

## 4. REAR DOOR SPEAKER SIGNAL CHECK

A  
B  
C  
D  
E  
F  
G  
H  
I  
J  
K  
L  
M  
O  
P

# REAR TWEETER (COUPE)

[BOSE AUDIO WITHOUT NAVIGATION]

## < COMPONENT DIAGNOSIS >

1. Connect audio unit connector M43 and BOSE speaker amp. connector B121.
2. Turn ignition switch to ACC.
3. Push "POWER" switch.
4. Check the signal between audio unit harness connector M43 terminals with CONSULT-III or oscilloscope.

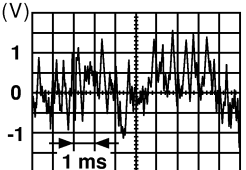
Connector	Terminals		Condition	Reference signal
	(+)	(-)		
M43	4	5	Receive audio signal	 <p style="text-align: right; font-size: small;">SKIA0177E</p>
	13	14		

Is the audio signal voltage reading as specified?

- YES >> Replace BOSE speaker amp. Refer to [AV-205, "Removal and Installation - Coupe"](#).
- NO >> Replace audio unit. Refer to [AV-204, "Removal and Installation"](#).

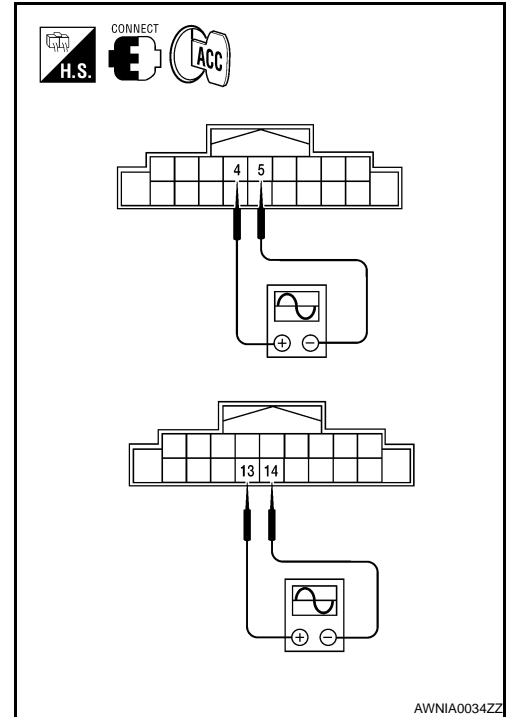

# REAR DOOR SPEAKER (SEDAN)

[BOSE AUDIO WITHOUT NAVIGATION]

< COMPONENT DIAGNOSIS >

## REAR DOOR SPEAKER (SEDAN)

### Description

INFOID:000000003188243

The audio unit sends audio signals to the BOSE speaker amp. The BOSE speaker amp. amplifies the audio signals before sending them to the rear door speakers using the audio signal circuits.

### Diagnosis Procedure

INFOID:000000003188244

#### 1. HARNESS CHECK

1. Disconnect BOSE speaker amp. connectors B121, B122 and suspect speaker connector.
2. Check continuity between BOSE speaker amp. harness connectors B121 (A) and B122 (B) and suspect speaker harness connector (C).

Connector	Terminal	Connector	Terminal	Continuity
A: B121	55	C: D202	2	Yes
	68		1	
B: B122	49	C: D302	2	
	54		1	

3. Check continuity between BOSE speaker amp. harness connectors B121 (A) and B122 (B) and ground.

Connector	Terminal	-	Continuity
A: B121	55	Ground	No
	68		
B: B122	49		
	54		

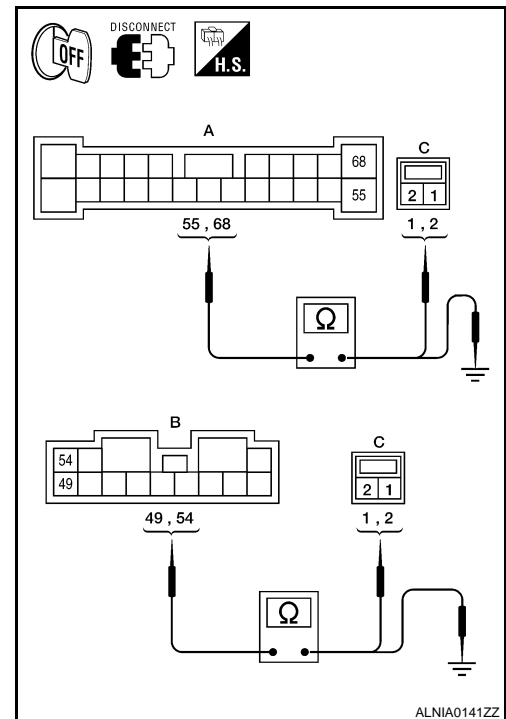

ALNIA0141ZZ

Are the continuity test results as specified?

YES >> GO TO 2

- NO >> • Check connector housings for disconnected or loose terminals.  
• Repair harness or connector.

#### 2. REAR DOOR SPEAKER SIGNAL CHECK

A  
B  
C  
D  
E  
F  
G  
H  
I  
J  
K  
L  
M  
O  
P

AV

# REAR DOOR SPEAKER (SEDAN)

[BOSE AUDIO WITHOUT NAVIGATION]

## < COMPONENT DIAGNOSIS >

1. Connect BOSE speaker amp. connectors and suspect speaker connector.
2. Turn ignition switch to ACC.
3. Push "POWER" switch.
4. Check the signal between BOSE speaker amp. harness connectors B121 (A) and B122 (B) terminals with CONSULT-III or oscilloscope.

Connector	Terminals		Condition	Reference signal
	(+)	(-)		
A: B121	68	55	Receive audio signal	
B: B122	54	49		

SKIA0177E

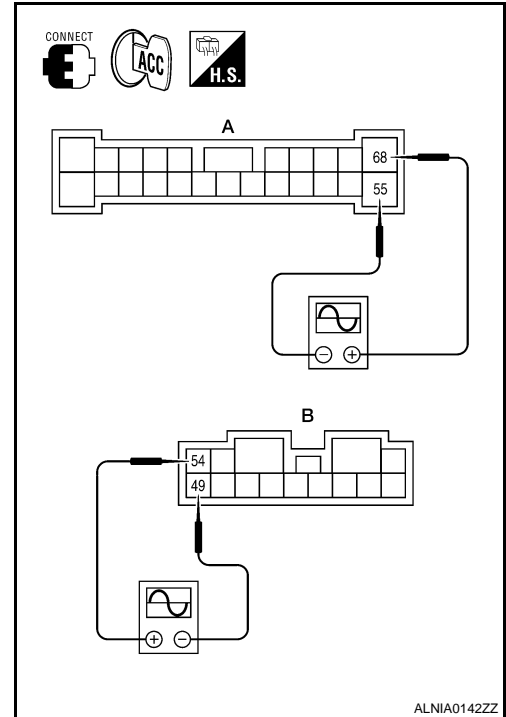

Are audio signal voltage readings as specified?

- YES >> Replace suspect speaker. Refer to [AV-210, "Removal and Installation - Sedan"](#).
- NO >> GO TO 3

## 3. HARNESS CHECK

1. Disconnect audio unit connector M43 and BOSE speaker amp. connector B121.
2. Check continuity between audio unit harness connector M43 (A) and BOSE speaker amp. harness connector B121 (B).

A		B		Continuity
Connector	Terminal	Connector	Terminal	
M43	4	B121	64	Yes
	5		63	
	13		66	
	14		65	

3. Check continuity between audio unit harness connector M43 (A) and ground.

A		—	Continuity
Connector	Terminal		
M43	4	Ground	No
	5		
	13		
	14		

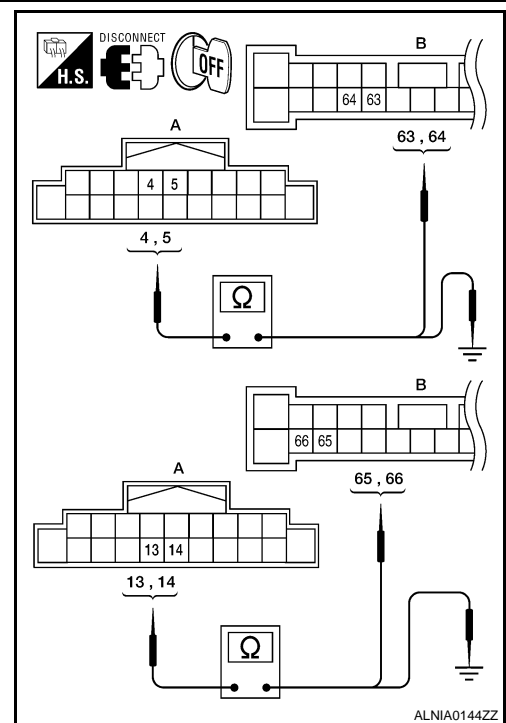

Are the continuity test results as specified?

- YES >> GO TO 4
- NO >> • Check connector housings for disconnected or loose terminals.  
• Repair harness or connector.

## 4. REAR DOOR SPEAKER SIGNAL CHECK

# REAR DOOR SPEAKER (SEDAN)

[BOSE AUDIO WITHOUT NAVIGATION]

## < COMPONENT DIAGNOSIS >

1. Connect audio unit connector M43 and BOSE speaker amp. connector B121.
2. Turn ignition switch to ACC.
3. Push "POWER" switch.
4. Check the signal between audio unit harness connector M43 terminals with CONSULT-III or oscilloscope.

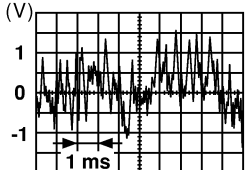
Connector	Terminals		Condition	Reference signal
	(+)	(-)		
M43	4	5	Receive audio signal	 <p style="text-align: right; font-size: small;">SKIA0177E</p>
	13	14		

Is the audio signal voltage reading as specified?

- YES >> Replace BOSE speaker amp. Refer to [AV-205, "Removal and Installation - Sedan"](#).
- NO >> Replace audio unit. Refer to [AV-204, "Removal and Installation"](#).

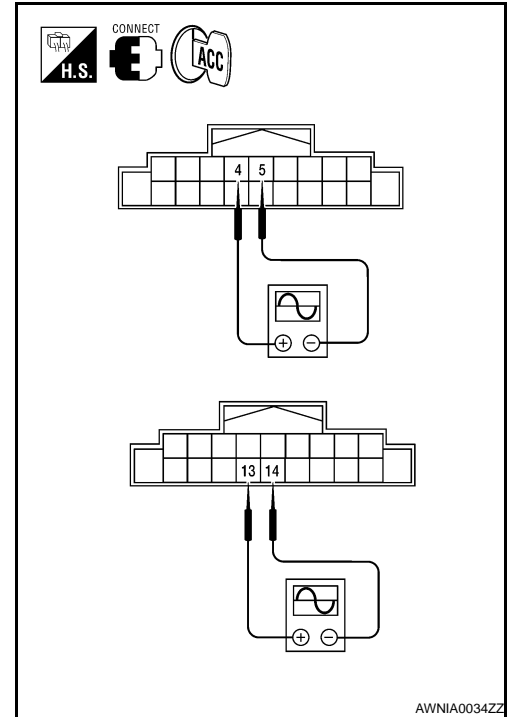

A  
B  
C  
D  
E  
F  
G  
H  
I  
J  
K  
L  
M  
O  
P

AV

# SUBWOOFER

< COMPONENT DIAGNOSIS >

[BOSE AUDIO WITHOUT NAVIGATION]

## SUBWOOFER

### Description

INFOID:000000001830623

The audio unit sends audio signals to the BOSE speaker amp. The BOSE speaker amp. amplifies the audio signals before sending them to the subwoofers using the audio signal circuits.

### Diagnosis Procedure

INFOID:000000001830624

#### 1. HARNESS CHECK

1. Disconnect BOSE speaker amp. connector B122 and suspect rear subwoofer connector.
2. Check continuity between BOSE speaker amp. harness connector B122 (A) and suspect rear subwoofer harness connector (B).

A		B		Continuity
Connector	Terminal	Connector	Terminal	
B122	53	B120	1	Yes
	48		2	
	45	B124	1	
	46		2	

3. Check continuity between BOSE speaker amp. harness connector B122 (A) and ground.

A		—	Continuity
Connector	Terminal		
B122	53	Ground	No
	48		
	45		
	46		

Are the continuity test results as specified?

YES >> GO TO 2

- NO >> • Check connector housings for disconnected or loose terminals.  
• Repair harness or connector.

#### 2. REAR SUBWOOFER SIGNAL CHECK

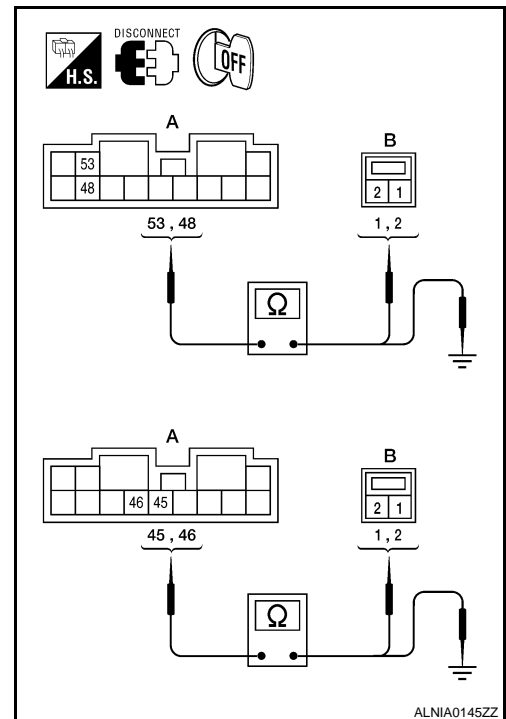

# SUBWOOFER

[BOSE AUDIO WITHOUT NAVIGATION]

## < COMPONENT DIAGNOSIS >

1. Connect BOSE speaker amp. connector B122 and suspect rear subwoofer connector.
2. Turn ignition switch to ACC.
3. Push "POWER" switch.
4. Check the signal between BOSE speaker amp. harness connector B122 terminals with CONSULT-III or oscilloscope.

Connector	Terminals		Condition	Reference signal
	(+)	(-)		
B122	53	48	Receive audio signal	
	45	46		

SKIA0177E

Is the audio signal voltage as specified?

YES >> Replace suspect rear subwoofer. Refer to [AV-213](#), "[Removal and Installation](#)".

NO >> GO TO 3

### 3. HARNESS CHECK

1. Disconnect audio unit connector M43 and BOSE speaker amp. connector B121.
2. Check continuity between audio unit harness connector M43 (A) and BOSE speaker amp. harness connector B121 (B).

A		B		Continuity
Connector	Terminal	Connector	Terminal	
M43	4	B121	64	Yes
	5		63	
	13		66	
	14		65	

3. Check continuity between audio unit harness connector M43 (A) terminal and ground.

A		—	Continuity
Connector	Terminal		
M43	4	Ground	No
	5		
	13		
	14		

Are continuity test results as specified?

YES >> GO TO 4

NO >> • Check connector housings for disconnected or loose terminals.  
• Repair harness or connector.

### 4. REAR SUBWOOFER SIGNAL CHECK

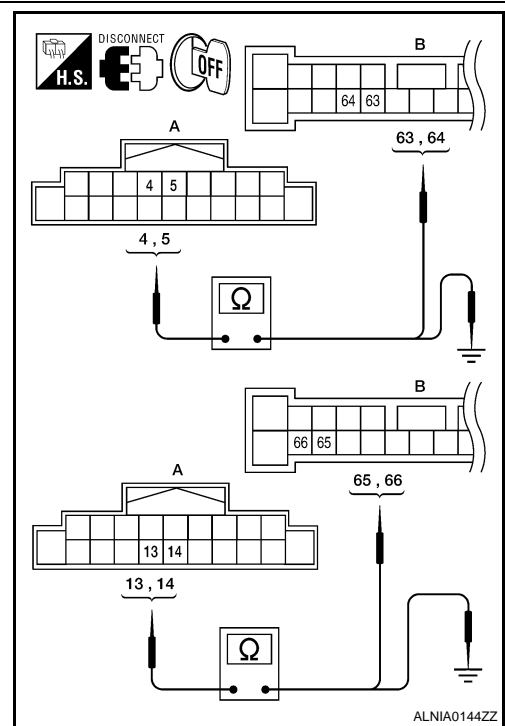
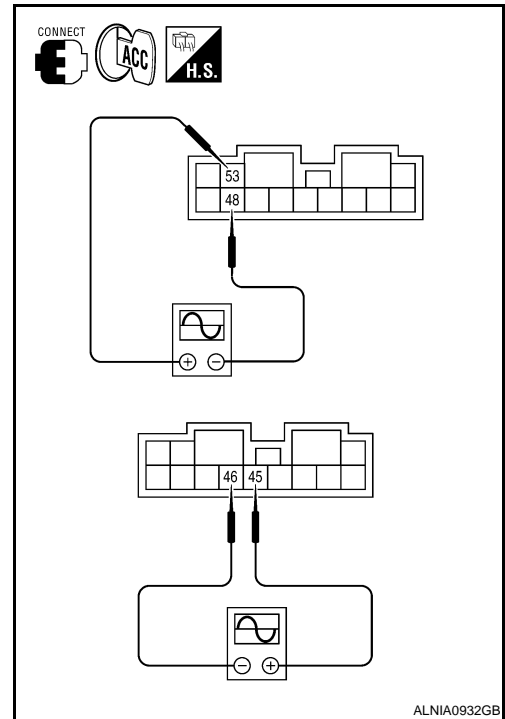

A  
B  
C  
D  
E  
F  
G  
H  
I  
J  
K  
L  
M  
AV  
O  
P

# SUBWOOFER

[BOSE AUDIO WITHOUT NAVIGATION]

## < COMPONENT DIAGNOSIS >

1. Connect audio unit connector M43 and BOSE speaker amp. connector B121.
2. Turn ignition switch to ACC.
3. Push "POWER" switch.
4. Check the signal between audio unit harness connector M43 terminals with CONSULT-III or oscilloscope.

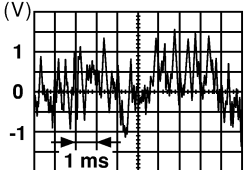
Connector	Terminals		Condition	Reference signal
	(+)	(-)		
M43	4	5	Receive audio signal	 <p>SKIA0177E</p>
	13	14		

Is the audio signal voltage as specified?

- YES >> Replace BOSE speaker amp. Refer to [AV-205, "Removal and Installation - Coupe"](#).
- NO >> Replace audio unit. Refer to [AV-204, "Removal and Installation"](#).

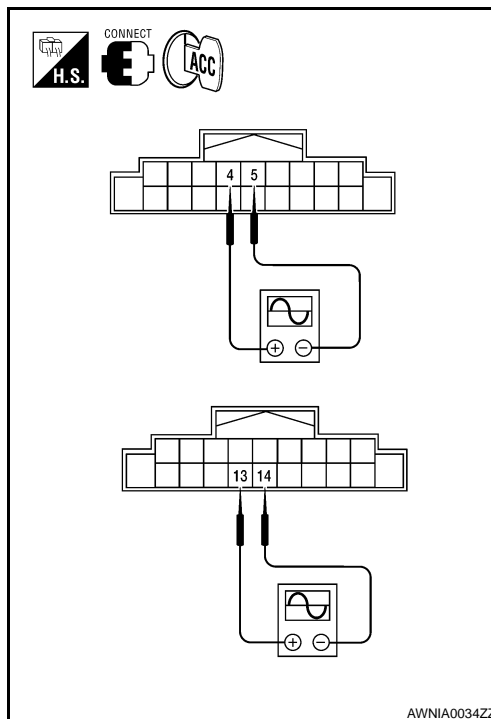



# AMP ON SIGNAL CIRCUIT

< COMPONENT DIAGNOSIS >

[BOSE AUDIO WITHOUT NAVIGATION]

## AMP ON SIGNAL CIRCUIT

### Description

INFOID:000000001830625

When the audio system is turned on, a voltage signal is supplied from the audio unit to the BOSE speaker amp. When this signal is received, the BOSE speaker amp. will turn on.

### Diagnosis Procedure

INFOID:000000001830626

#### 1. CHECK AMP ON SIGNAL (BOSE SPEAKER AMP)

1. Turn audio system ON.
2. Check voltage between BOSE speaker amp. harness connector B121 terminal 60 and ground.

**60 - Ground : More than approx. 6.5V**

Is voltage greater than 6.5V?

- YES >> Inspection End.  
NO >> GO TO 2

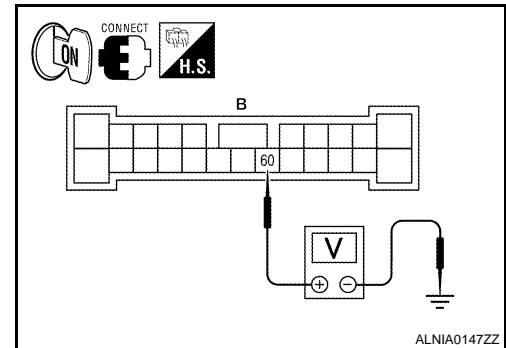

#### 2. CHECK AMP ON SIGNAL (AUDIO UNIT)

Check voltage between audio unit harness connector M43 terminal 1 and ground.

**1 - Ground : More than approx. 6.5V**

Is voltage greater than 6.5V?

- YES >> Repair harness or connector.  
NO >> Replace audio unit. Refer to [AV-204, "Removal and Installation"](#).

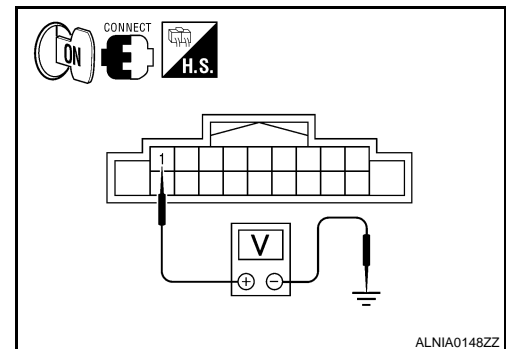

A  
B  
C  
D  
E  
F  
G  
H  
I  
J  
K  
L  
M  
O  
P

AV

# STEERING SWITCH (COUPE)

[BOSE AUDIO WITHOUT NAVIGATION]

< COMPONENT DIAGNOSIS >

## STEERING SWITCH (COUPE)

### Description

INFOID:000000001830627

When one of the steering wheel audio control switches is pushed, the resistance in the steering switch circuit changes depending on which button is pushed.

### Diagnosis Procedure

INFOID:000000001830628

#### WITH BLUETOOTH

#### 1. CHECK HARNESS

1. Turn ignition switch OFF.
2. Disconnect Bluetooth control unit connector B55 and spiral cable connector M30.
3. Check continuity between Bluetooth control unit connector B55 (A) terminals and spiral cable connector M30 (B) terminals.

A		B		Continuity
Connector	Terminal	Connector	Terminal	
B55	12	M30	24	Yes
	13		31	
	14		33	

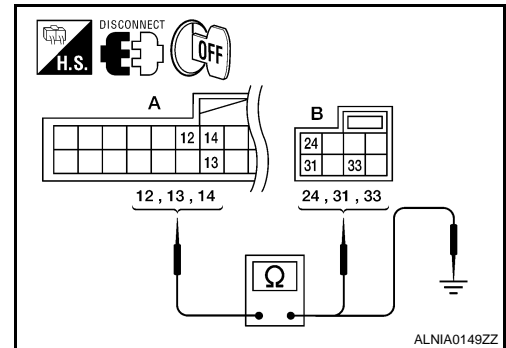

4. Check continuity between Bluetooth control unit B55 (A) and ground.

A		-	Continuity
Connector	Terminal		
B55	12	Ground	No
	13		
	14		

Are the continuity test results as specified?

- YES >> GO TO 2  
 NO >> Repair harness.

#### 2. CHECK HARNESS

1. Disconnect audio unit connector.
2. Check continuity between audio unit connector M43 (A) terminals and Bluetooth control unit connector B55 (B) terminals.

A		B		Continuity
Connector	Terminal	Connector	Terminal	
M43	6	B55	17	Yes
	15		19	
	16		18	

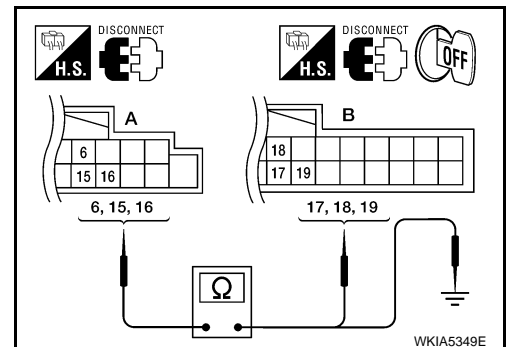

Are the continuity test results as specified?

- YES >> GO TO 3  
 NO >> Repair harness.

#### 3. SPIRAL CABLE CHECK

# STEERING SWITCH (COUPE)

[BOSE AUDIO WITHOUT NAVIGATION]

## < COMPONENT DIAGNOSIS >

1. Disconnect spiral cable connector M88.
2. Check continuity between spiral cable harness connector M30 and M88.

A		B		Continuity
Connector	Terminal	Connector	Terminal	
M30	24	M88	14	Yes
	31		15	
	33		17	

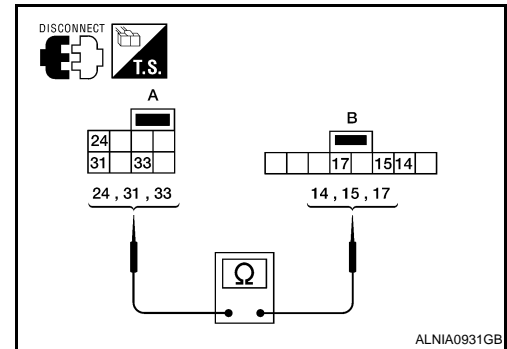

Are the continuity test results as specified?

YES >> GO TO 4

NO >> Replace spiral cable. Refer to [SR-6, "Removal and Installation"](#).

## 4. CHECK STEERING SWITCH

Check steering switch. Refer to [AV-136, "Component Inspection"](#).

Does the steering switch pass inspection?

YES >> Replace Bluetooth control unit. Refer to [AV-227, "Removal and Installation - Coupe"](#)

NO >> Replace steering switch. Refer to [AV-216, "Removal and Installation"](#).

## WITHOUT BLUETOOTH

## 1. CHECK STEERING SWITCH

Check steering switch. Refer to [AV-136, "Component Inspection"](#).

Does the steering switch pass inspection?

YES >> GO TO 2

NO >> Replace steering switch. Refer to [AV-216, "Removal and Installation"](#).

## 2. CHECK HARNESS

1. Turn ignition switch OFF.
2. Disconnect audio unit connector M43 and spiral cable connector M30.
3. Check continuity between spiral cable harness connector M30 (B) and audio unit harness connector M43 (A).

B		A		Continuity
Connector	Terminal	Connector	Terminal	
M30	24	M43	6	Yes
	31		16	
	33		15	

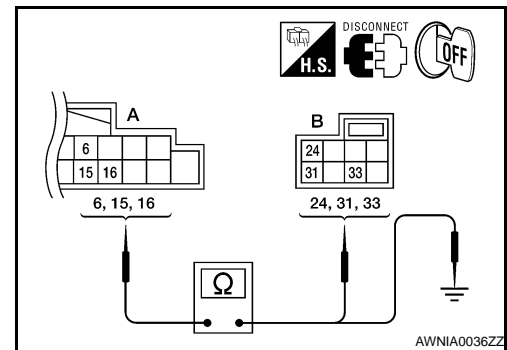

4. Check continuity between audio unit connector M43 (A) and ground.

A		—	Continuity
Connector	Terminal		
M43	6	Ground	No
	15		
	16		

Are the continuity test results as specified?

YES >> GO TO 3

NO >> Repair harness.

## 3. SPIRAL CABLE CHECK

# STEERING SWITCH (COUPE)

[BOSE AUDIO WITHOUT NAVIGATION]

## < COMPONENT DIAGNOSIS >

1. Disconnect spiral cable connector M88.
2. Check continuity between spiral cable harness connector M30 and M88.

A		B		Continuity
Connector	Terminal	Connector	Terminal	
M30	24	M88	14	Yes
	31		15	
	33		17	

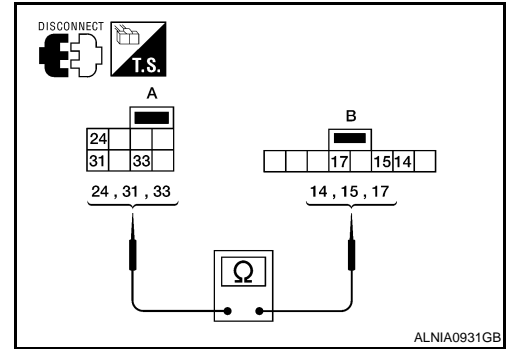

Are the continuity test results as specified?

YES >> Inspection End.

NO >> Replace spiral cable. Refer to [SR-6. "Removal and Installation"](#).

## Component Inspection

INFOID:000000001830629

### WITH BLUETOOTH

Measure the resistance between the steering switch connector terminals 14 to 17 and 15 to 17.

Standard

**Between terminals 14 and 17**

- switch ON** : 0 Ω
- SEEK UP switch ON** : 108 – 112 Ω
- SEEK DOWN switch ON** : 323 – 337 Ω

**Between terminals 15 and 17**

- VOL DOWN switch ON** : 0 Ω
- VOL UP switch ON** : 108 – 112 Ω
- switch ON** : 323 – 337 Ω
- SOURCE switch ON** : 990 – 1030 Ω

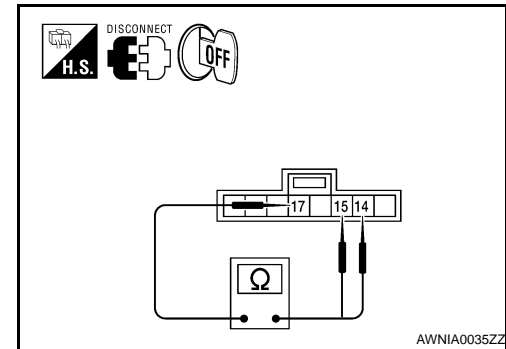

### WITHOUT BLUETOOTH

Measure the resistance between the steering switch connector terminals 14 to 17 and 15 to 17.

Standard

**Between terminals 14 and 17**

- SOURCE switch ON** : 0 Ω
- SEEK UP switch ON** : 162 – 168 Ω
- VOLUME UP switch ON** : 639 – 665 Ω

**Between terminals 15 and 17**

- SEEK DOWN switch ON** : 162 – 168 Ω
- VOL DOWN switch ON** : 639 – 665 Ω

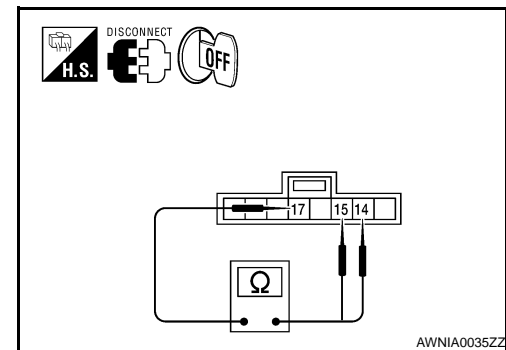

# STEERING SWITCH (SEDAN)

[BOSE AUDIO WITHOUT NAVIGATION]

< COMPONENT DIAGNOSIS >

## STEERING SWITCH (SEDAN)

### Description

INFOID:00000000322175

When one of the steering wheel audio control switches is pushed, the resistance in steering switch circuit changes depending on which button is pushed.

### Diagnosis Procedure

INFOID:00000000322176

#### WITH BLUETOOTH

#### 1. CHECK HARNESS

1. Turn ignition switch OFF.
2. Disconnect Bluetooth control unit connector B126 and spiral cable connector M30.
3. Check continuity between Bluetooth control unit connector B126 (A) terminals and spiral cable connector M30 (B) terminals.

A		B		Continuity
Connector	Terminal	Connector	Terminal	
B126	12	M30	24	Yes
	13		31	
	14		33	

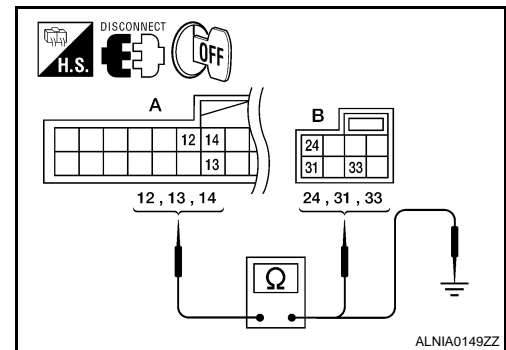

4. Check continuity between Bluetooth control unit B126 (A) and ground.

A		-	Continuity
Connector	Terminal		
B126	12	Ground	No
	13		
	14		

Are the continuity test results as specified?

- YES >> GO TO 2  
 NO >> Repair harness.

#### 2. CHECK HARNESS

1. Disconnect audio unit connector.
2. Check continuity between audio unit connector M43 (A) terminals and Bluetooth control unit connector B126 (B) terminals.

A		B		Continuity
Connector	Terminal	Connector	Terminal	
M43	6	B126	17	Yes
	15		19	
	16		18	

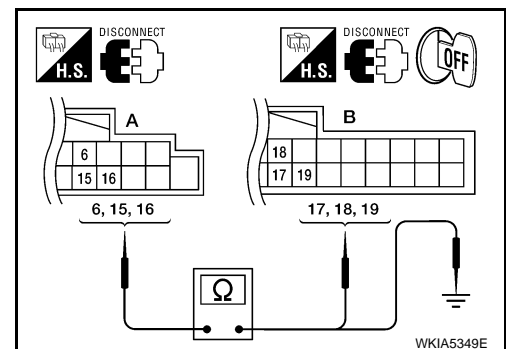

Are the continuity test results as specified?

- YES >> GO TO 3  
 NO >> Repair harness.

#### 3. SPIRAL CABLE CHECK

A  
B  
C  
D  
E  
F  
G  
H  
I  
J  
K  
L  
M  
AV  
O  
P

# STEERING SWITCH (SEDAN)

[BOSE AUDIO WITHOUT NAVIGATION]

## < COMPONENT DIAGNOSIS >

1. Disconnect spiral cable connector M88.
2. Check continuity between spiral cable harness connector M30 and M88.

A		B		Continuity
Connector	Terminal	Connector	Terminal	
M30	24	M88	14	Yes
	31		15	
	33		17	

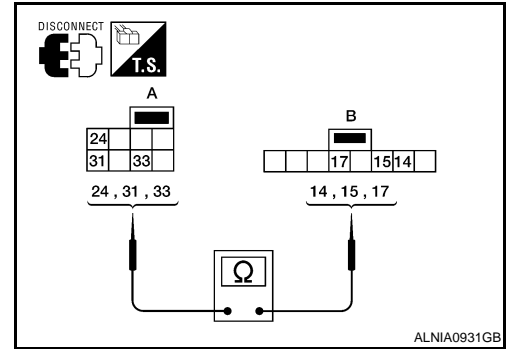

Are the continuity test results as specified?

YES >> GO TO 4

NO >> Replace spiral cable. Refer to [SR-6, "Removal and Installation"](#).

## 4. CHECK STEERING SWITCH

Check steering switch. Refer to [AV-139, "Component Inspection"](#).

Does the steering switch pass inspection?

YES >> Replace Bluetooth control unit. Refer to [AV-227, "Removal and Installation - Sedan"](#)

NO >> Replace steering switch. Refer to [AV-216, "Removal and Installation"](#).

## WITHOUT BLUETOOTH

## 1. CHECK STEERING SWITCH

Check steering switch. Refer to [AV-139, "Component Inspection"](#).

Does the steering switch pass inspection?

YES >> GO TO 2

NO >> Replace steering switch. Refer to [AV-216, "Removal and Installation"](#).

## 2. CHECK HARNESS

1. Turn ignition switch OFF.
2. Disconnect audio unit connector M43 and spiral cable connector M30.
3. Check continuity between spiral cable harness connector M30 (B) and audio unit harness connector M43 (A).

B		A		Continuity
Connector	Terminal	Connector	Terminal	
M30	24	M43	6	Yes
	31		16	
	33		15	

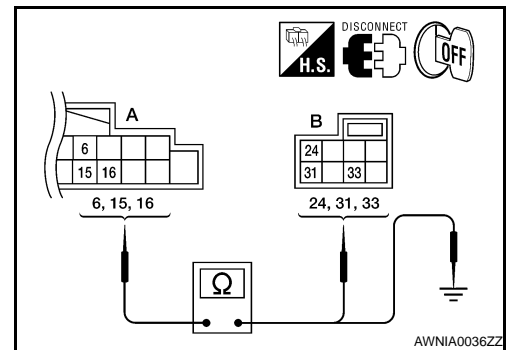

4. Check continuity between audio unit connector M43 (A) and ground.

A		—	Continuity
Connector	Terminal		
M43	6	Ground	No
	15		
	16		

Are the continuity test results as specified?

YES >> GO TO 3

NO >> Repair harness.

## 3. SPIRAL CABLE CHECK

# STEERING SWITCH (SEDAN)

[BOSE AUDIO WITHOUT NAVIGATION]

## < COMPONENT DIAGNOSIS >

1. Disconnect spiral cable connector M88.
2. Check continuity between spiral cable harness connector M30 and M88.

A		B		Continuity
Connector	Terminal	Connector	Terminal	
M30	24	M88	14	Yes
	31		15	
	33		17	

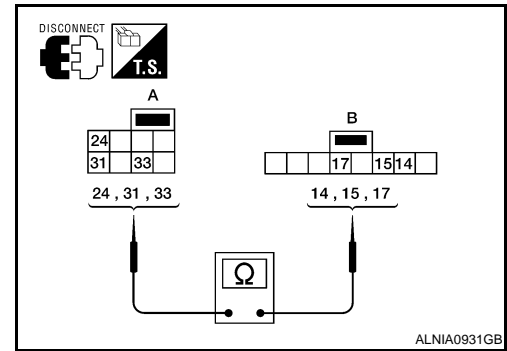

Are the continuity test results as specified?

- YES >> Inspection End.  
 NO >> Replace spiral cable. Refer to [SR-6. "Removal and Installation"](#).

## Component Inspection

INFOID:000000003222177

### WITH BLUETOOTH

Measure the resistance between the steering switch connector terminals 14 to 17 and 15 to 17.

Standard

#### Between terminals 14 and 17

- switch ON : 0 Ω
- SEEK UP switch ON : 108 – 112 Ω
- SEEK DOWN switch ON : 323 – 337 Ω

#### Between terminals 15 and 17

- VOL DOWN switch ON : 0 Ω
- VOL UP switch ON : 108 – 112 Ω
- switch ON : 323 – 337 Ω
- SOURCE switch ON : 990 – 1030 Ω

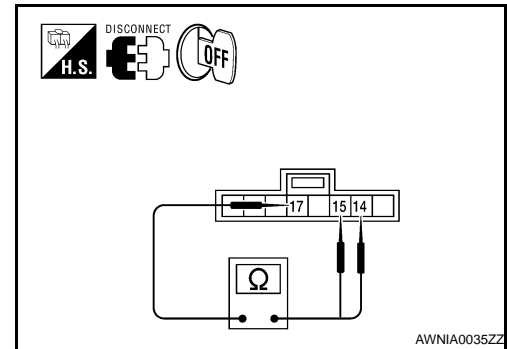

### WITHOUT BLUETOOTH

Measure the resistance between the steering switch connector terminals 14 to 17 and 15 to 17.

Standard

#### Between terminals 14 and 17

- SOURCE switch ON : 0 Ω
- SEEK UP switch ON : 162 – 168 Ω
- VOLUME UP switch ON : 639 – 665 Ω

#### Between terminals 15 and 17

- SEEK DOWN switch ON : 162 – 168 Ω
- VOL DOWN switch ON : 639 – 665 Ω

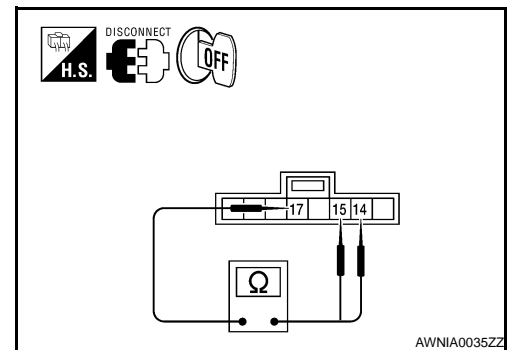

A  
B  
C  
D  
E  
F  
G  
H  
I  
J  
K  
L  
M  
AV  
O  
P

# COMMUNICATION SIGNAL CIRCUIT (COUPE)

[BOSE AUDIO WITHOUT NAVIGATION]

< COMPONENT DIAGNOSIS >

## COMMUNICATION SIGNAL CIRCUIT (COUPE)

### SATELLITE RADIO TUNER

#### SATELLITE RADIO TUNER : Description

INFOID:000000003188248

Communication signals are exchanged between the audio unit and satellite radio tuner using the communication circuits.

#### SATELLITE RADIO TUNER : Diagnosis Procedure

INFOID:000000003188249

### 1.CHECK HARNESS - 1

1. Turn ignition switch OFF.
2. Disconnect satellite radio tuner (factory installed) connector B57 and audio unit connector M45.
3. Check continuity between satellite radio tuner (factory installed) harness connector B57 (A) terminal 28 and audio unit harness connector M45 (B) terminal 38.

**Continuity should exist.**

4. Check continuity between satellite radio tuner (factory installed) harness connector B57 (A) terminal 28 and ground.

**Continuity should not exist.**

Are continuity results as specified?

YES >> GO TO 2

NO >> Repair harness or connector.

### 2.CHECK HARNESS - 2

1. Check continuity between satellite radio tuner (factory installed) harness connector B57 (A) terminal 29 and audio unit harness connector M45 (B) terminal 39.

**Continuity should exist.**

2. Check continuity between satellite radio tuner (factory installed) harness connector B57 (A) terminal 29 and ground.

**Continuity should not exist.**

Are continuity results as specified?

YES >> GO TO 3

NO >> Repair harness or connector.

### 3.CHECK HARNESS - 3

1. Check continuity between satellite radio tuner (factory installed) harness connector B57 (A) terminal 30 and audio unit harness connector M45 (B) terminal 40.

**Continuity should exist.**

2. Check continuity between satellite radio tuner (factory installed) harness connector B57 (A) terminal 30 and ground.

**Continuity should not exist.**

Are continuity results as specified?

YES >> GO TO 4

NO >> Repair harness or connector.

### 4.CHECK REQ1 SIGNAL

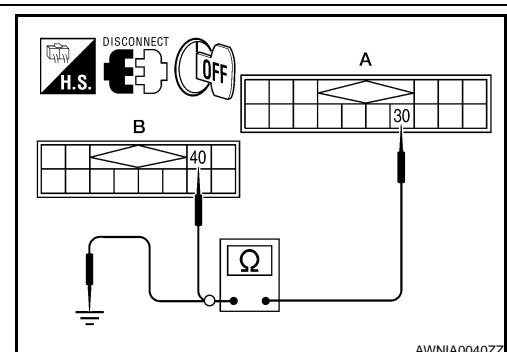
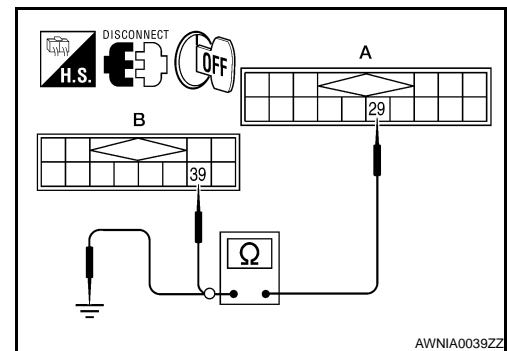
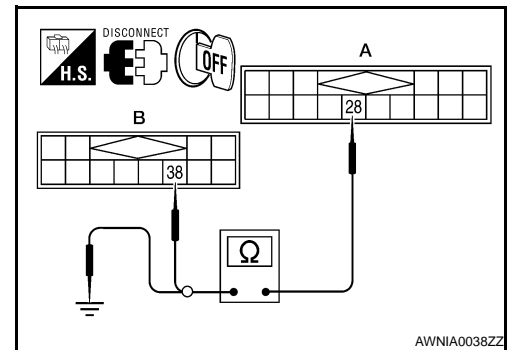



# COMMUNICATION SIGNAL CIRCUIT (COUPE)

[BOSE AUDIO WITHOUT NAVIGATION]

## < COMPONENT DIAGNOSIS >

1. Connect satellite radio tuner (factory installed) connector and audio unit connector.
2. Turn ignition switch to ACC
3. Check signal between satellite radio tuner (factory installed) harness connector B57 terminal 28 and ground with CONSULT-III or oscilloscope.

### 28 - Ground

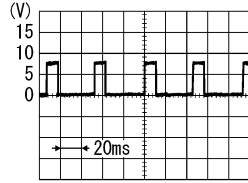

SKIB3825E

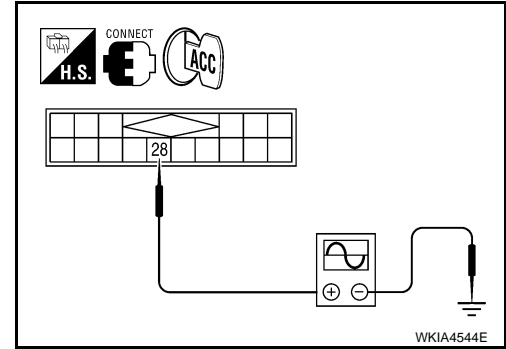

Are voltage readings as specified?

YES >> GO TO 5

NO >> Replace audio unit. Refer to [AV-70, "Removal and Installation"](#).

## 5. CHECK TXD SIGNAL

Check signal between satellite radio tuner (factory installed) harness connector B57 terminal 29 and ground with CONSULT-III or oscilloscope.

### 29 - Ground

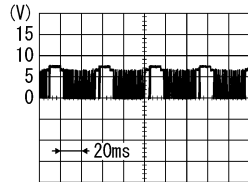

SKIB3824E

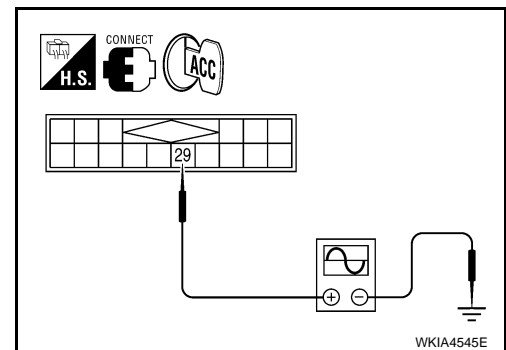

Are the voltage readings as specified?

YES >> GO TO 6

NO >> Replace satellite radio tuner.

## 6. CHECK RXD SIGNAL

Check signal between satellite radio tuner (factory installed) harness connector B57 terminal 30 and ground with CONSULT-III or oscilloscope.

### 30 - Ground

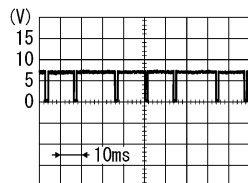

SKIB3826E

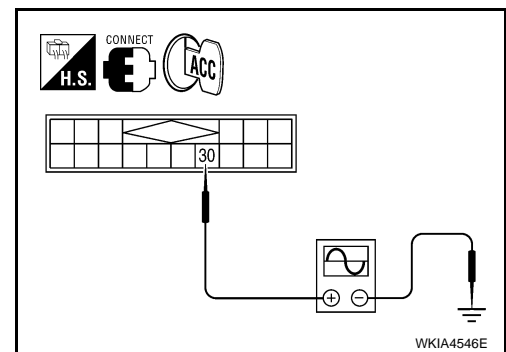

Are the voltage readings as specified?

YES >> Replace satellite radio tuner.

NO >> Replace audio unit. Refer to [AV-70, "Removal and Installation"](#).

A  
B  
C  
D  
E  
F  
G  
H  
I  
J  
K  
L  
M  
AV  
O  
P

# COMMUNICATION SIGNAL CIRCUIT (SEDAN)

[BOSE AUDIO WITHOUT NAVIGATION]

< COMPONENT DIAGNOSIS >

## COMMUNICATION SIGNAL CIRCUIT (SEDAN)

### SATELLITE RADIO TUNER

#### SATELLITE RADIO TUNER : Description

INFOID:00000000322180

Communication signals are exchanged between the audio unit and satellite radio tuner using the communication circuits.

#### SATELLITE RADIO TUNER : Diagnosis Procedure

INFOID:00000000322182

### 1.CHECK HARNESS - 1

1. Turn ignition switch OFF.
2. Disconnect satellite radio tuner (factory installed) connector B123 and audio unit connector M45.
3. Check continuity between satellite radio tuner (factory installed) harness connector B123 (A) terminal 28 and audio unit harness connector M45 (B) terminal 38.

**Continuity should exist.**

4. Check continuity between satellite radio tuner (factory installed) harness connector B123 (A) terminal 28 and ground.

**Continuity should not exist.**

Are continuity results as specified?

YES >> GO TO 2

NO >> Repair harness or connector.

### 2.CHECK HARNESS - 2

1. Check continuity between satellite radio tuner (factory installed) harness connector B123 (A) terminal 29 and audio unit harness connector M45 (B) terminal 39.

**Continuity should exist.**

2. Check continuity between satellite radio tuner (factory installed) harness connector B123 (A) terminal 29 and ground.

**Continuity should not exist.**

Are continuity results as specified?

YES >> GO TO 3

NO >> Repair harness or connector.

### 3.CHECK HARNESS - 3

1. Check continuity between satellite radio tuner (factory installed) harness connector B123 (A) terminal 30 and audio unit harness connector M45 (B) terminal 40.

**Continuity should exist.**

2. Check continuity between satellite radio tuner (factory installed) harness connector B123 (A) terminal 30 and ground.

**Continuity should not exist.**

Are continuity results as specified?

YES >> GO TO 4

NO >> Repair harness or connector.

### 4.CHECK REQ1 SIGNAL

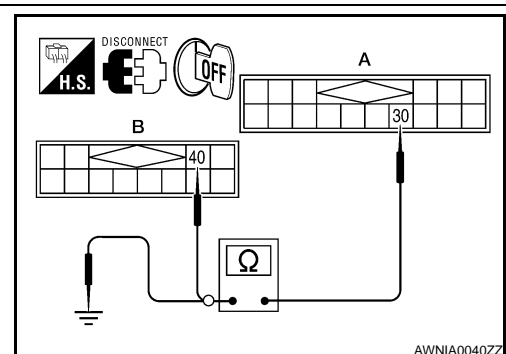
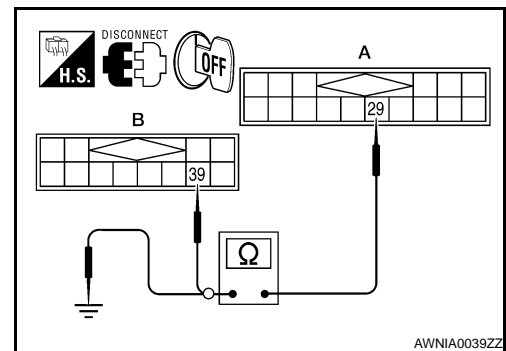
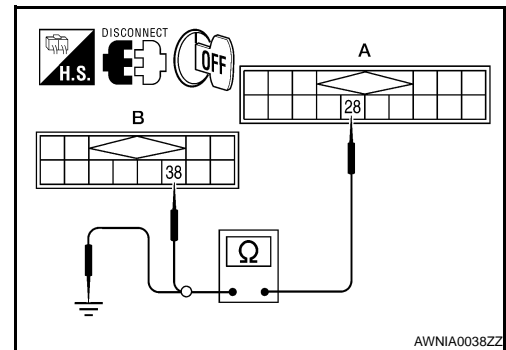

# COMMUNICATION SIGNAL CIRCUIT (SEDAN)

[BOSE AUDIO WITHOUT NAVIGATION]

## < COMPONENT DIAGNOSIS >

1. Connect satellite radio tuner (factory installed) connector and audio unit connector.
2. Turn ignition switch to ACC
3. Check signal between satellite radio tuner (factory installed) harness connector B123 terminal 28 and ground with CONSULT-III or oscilloscope.

### 28 - Ground

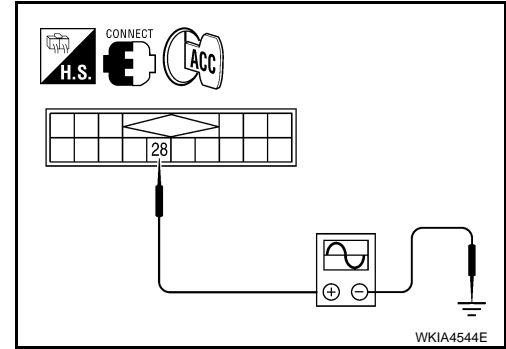
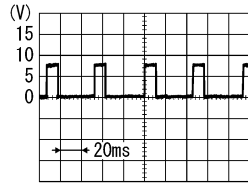

Are voltage readings as specified?

YES >> GO TO 5

NO >> Replace audio unit. Refer to [AV-70, "Removal and Installation"](#).

## 5. CHECK TXD SIGNAL

Check signal between satellite radio tuner (factory installed) harness connector B123 terminal 29 and ground with CONSULT-III or oscilloscope.

### 29 - Ground

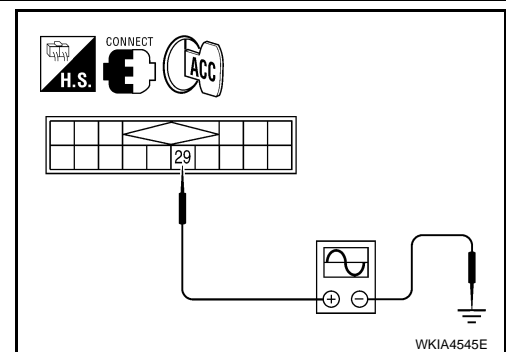
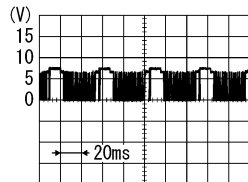

Are the voltage readings as specified?

YES >> GO TO 6

NO >> Replace satellite radio tuner.

## 6. CHECK RXD SIGNAL

Check signal between satellite radio tuner (factory installed) harness connector B123 terminal 30 and ground with CONSULT-III or oscilloscope.

### 30 - Ground

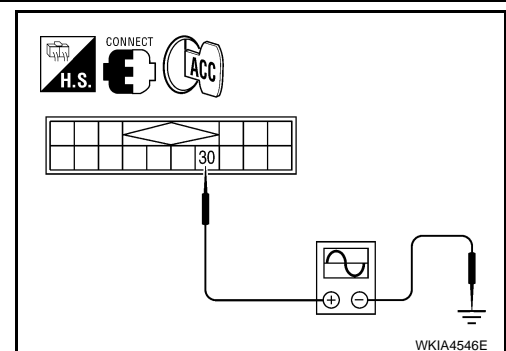
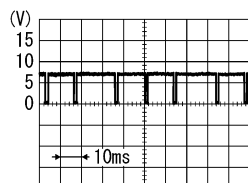

Are the voltage readings as specified?

YES >> Replace satellite radio tuner.

NO >> Replace audio unit. Refer to [AV-70, "Removal and Installation"](#).

A  
B  
C  
D  
E  
F  
G  
H  
I  
J  
K  
L  
M  
AV  
O  
P

# SOUND SIGNAL CIRCUIT (COUPE)

[BOSE AUDIO WITHOUT NAVIGATION]

< COMPONENT DIAGNOSIS >

## SOUND SIGNAL CIRCUIT (COUPE) SATELLITE RADIO TUNER

### SATELLITE RADIO TUNER : Description

INFOID:000000003188251

Left and right channel audio signals are supplied from the satellite radio tuner to the audio unit through the sound signal circuits.

### SATELLITE RADIO TUNER : Diagnosis Procedure

INFOID:000000003188252

#### LEFT CHANNEL

##### 1.CHECK HARNESS

1. Turn ignition switch OFF.
2. Disconnect satellite radio tuner (factory installed) connector B57 and audio unit connector M45.
3. Check continuity between satellite radio tuner (factory installed) connector B57 (A) and audio unit connector M45 (B).

A		B		Continuity
Connector	Terminal	Connector	Terminal	
B57	21	M45	31	Yes
	22		32	

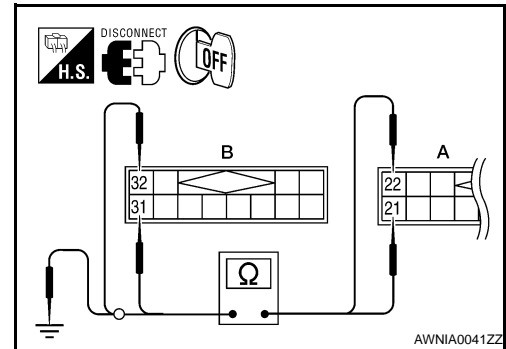

4. Check continuity between satellite radio tuner (factory installed) connector B57 (A) and ground.

A		—	Continuity
Connector	Terminal		
B57	21	Ground	No
	22		

Are continuity results as specified?

- YES >> GO TO 2  
NO >> Repair harness or connector.

##### 2.CHECK LEFT CHANNEL AUDIO SIGNAL

1. Connect satellite radio tuner (factory installed) and audio unit.
2. Turn ignition switch ON.
3. Check signal between satellite radio tuner (factory installed) connector B57 terminals 21 and 22 with CONSULT-III or oscilloscope.

21 - 22

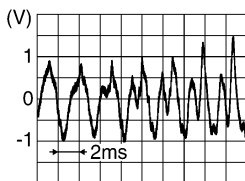

SKIB3609E

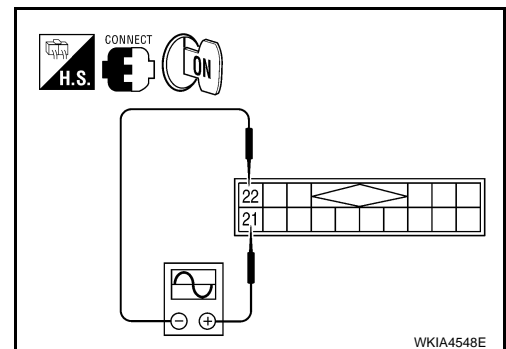

WKIA4548E

Are voltage readings as specified?

- YES >> Replace audio unit. Refer to [AV-70. "Removal and Installation"](#).  
NO >> Replace satellite radio tuner. Refer to [AV-214. "Removal and Installation - Coupe"](#).

#### RIGHT CHANNEL

##### 1.CHECK HARNESS

# SOUND SIGNAL CIRCUIT (COUPE)

[BOSE AUDIO WITHOUT NAVIGATION]

## < COMPONENT DIAGNOSIS >

1. Turn ignition switch OFF.
2. Disconnect satellite radio tuner (factory installed) connector B57 and audio unit connector M45.
3. Check continuity between satellite radio tuner (factory installed) connector B57 (A) and audio unit connector M45 (B).

A		B		Continuity
Connector	Terminal	Connector	Terminal	
B57	23	M45	33	Yes
	24		34	

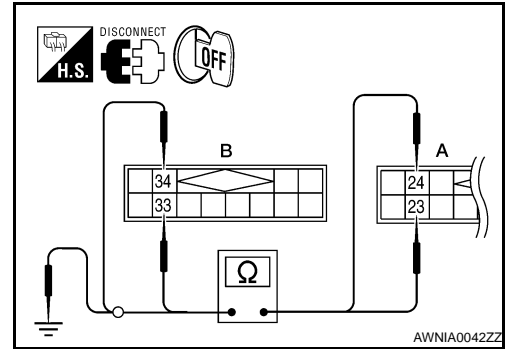

4. Check continuity between satellite radio tuner (factory installed) connector B57 (A) and ground.

A		—	Continuity
Connector	Terminal		
B57	23	Ground	No
	24		

Are continuity results as specified?

YES >> GO TO 2

NO >> Repair harness or connector.

## 2. CHECK RIGHT CHANNEL AUDIO SIGNAL

1. Connect satellite radio tuner (factory installed) and audio unit.
2. Turn ignition switch ON.
3. Check signal between satellite radio tuner (factory installed) connector B57 terminals 23 and 24 with CONSULT-III or oscilloscope.

**23 - 24**

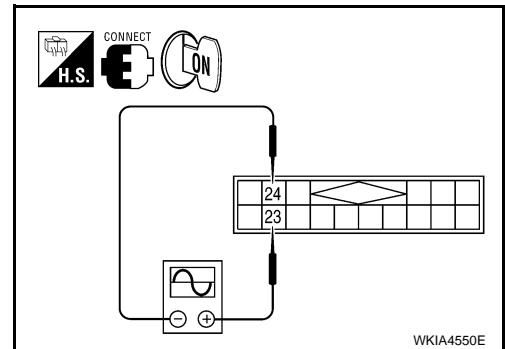
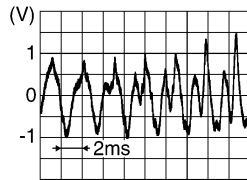

Are voltage readings as specified?

YES >> Replace audio unit. Refer to [AV-70, "Removal and Installation"](#).

NO >> Replace satellite radio tuner. Refer to [AV-214, "Removal and Installation - Coupe"](#).

A  
B  
C  
D  
E  
F  
G  
H  
I  
J  
K  
L  
M  
O  
P

# SOUND SIGNAL CIRCUIT (SEDAN)

< COMPONENT DIAGNOSIS >

[BOSE AUDIO WITHOUT NAVIGATION]

## SOUND SIGNAL CIRCUIT (SEDAN) SATELLITE RADIO TUNER

### SATELLITE RADIO TUNER : Description

INFOID:00000000322185

Left and right channel audio signals are supplied from the satellite radio tuner to the audio unit through the sound signal circuits.

### SATELLITE RADIO TUNER : Diagnosis Procedure

INFOID:00000000322187

#### LEFT CHANNEL

##### 1.CHECK HARNESS

1. Turn ignition switch OFF.
2. Disconnect satellite radio tuner (factory installed) connector B123 and audio unit connector M45.
3. Check continuity between satellite radio tuner (factory installed) connector B123 (A) and audio unit connector M45 (B).

A		B		Continuity
Connector	Terminal	Connector	Terminal	
B123	21	M45	31	Yes
	22		32	

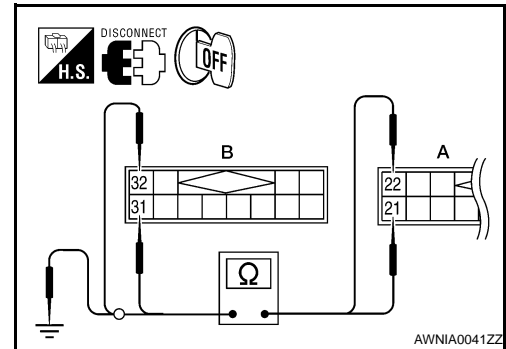

4. Check continuity between satellite radio tuner (factory installed) connector B123 (A) and ground.

A		—	Continuity
Connector	Terminal		
B123	21	Ground	No
	22		

Are continuity results as specified?

- YES >> GO TO 2  
NO >> Repair harness or connector.

##### 2.CHECK LEFT CHANNEL AUDIO SIGNAL

1. Connect satellite radio tuner (factory installed) and audio unit.
2. Turn ignition switch ON.
3. Check signal between satellite radio tuner (factory installed) connector B123 terminals 21 and 22 with CONSULT-III or oscilloscope.

21 - 22

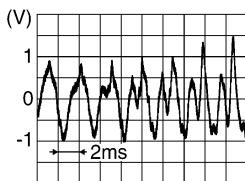

SKIB3609E

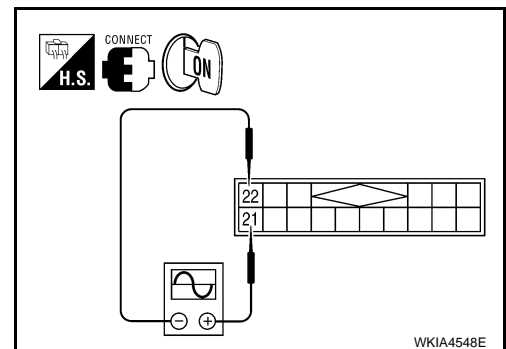

WKIA4548E

Are voltage readings as specified?

- YES >> Replace audio unit. Refer to [AV-70. "Removal and Installation"](#).  
NO >> Replace satellite radio tuner. Refer to [AV-214. "Removal and Installation - Sedan"](#).

#### RIGHT CHANNEL

##### 1.CHECK HARNESS

# SOUND SIGNAL CIRCUIT (SEDAN)

[BOSE AUDIO WITHOUT NAVIGATION]

## < COMPONENT DIAGNOSIS >

1. Turn ignition switch OFF.
2. Disconnect satellite radio tuner (factory installed) connector B123 and audio unit connector M45.
3. Check continuity between satellite radio tuner (factory installed) connector B123 (A) and audio unit connector M45 (B).

A		B		Continuity
Connector	Terminal	Connector	Terminal	
B123	23	M45	33	Yes
	24		34	

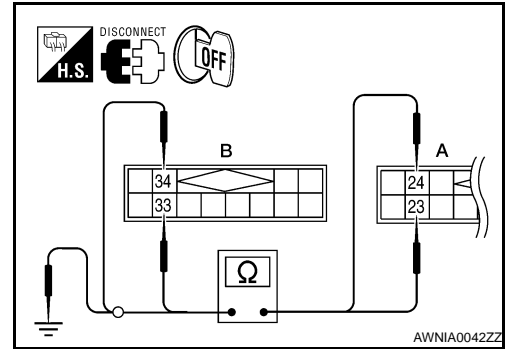

4. Check continuity between satellite radio tuner (factory installed) connector B123 (A) and ground.

A		—	Continuity
Connector	Terminal		
B123	23	Ground	No
	24		

Are continuity results as specified?

YES >> GO TO 2

NO >> Repair harness or connector.

## 2. CHECK RIGHT CHANNEL AUDIO SIGNAL

1. Connect satellite radio tuner (factory installed) and audio unit.
2. Turn ignition switch ON.
3. Check signal between satellite radio tuner (factory installed) connector B123 terminals 23 and 24 with CONSULT-III or oscilloscope.

**23 - 24**

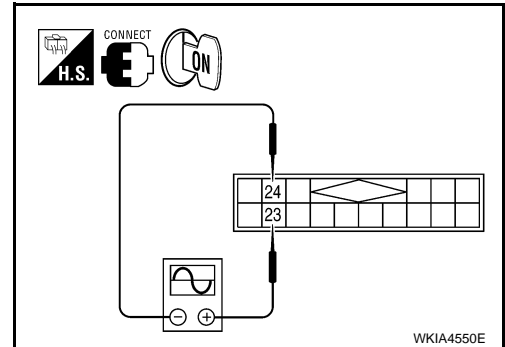
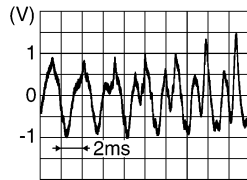

Are voltage readings as specified?

YES >> Replace audio unit. Refer to [AV-70, "Removal and Installation"](#).

NO >> Replace satellite radio tuner. Refer to [AV-214, "Removal and Installation - Sedan"](#).

A  
B  
C  
D  
E  
F  
G  
H  
I  
J  
K  
L  
M  
O  
P

# MICROPHONE SIGNAL CIRCUIT (COUPE)

< COMPONENT DIAGNOSIS >

[BOSE AUDIO WITHOUT NAVIGATION]

## MICROPHONE SIGNAL CIRCUIT (COUPE)

### Description

INFOID:000000001830634

Voice signals are transmitted from the microphone to the Bluetooth control unit using the microphone signal circuits.

### Diagnosis Procedure

INFOID:000000001830635

#### 1. CHECK HARNESS BETWEEN BLUETOOTH CONTROL UNIT AND MICROPHONE

1. Turn ignition switch OFF.
2. Disconnect Bluetooth control unit connector and microphone connector.
3. Check continuity between Bluetooth control unit harness connector B55 (A) and microphone harness connector R7 (B).

A		B		Continuity
Connector	Terminal	Connector	Terminal	
B55	7	R7	1	Yes
	8		2	
	29		4	

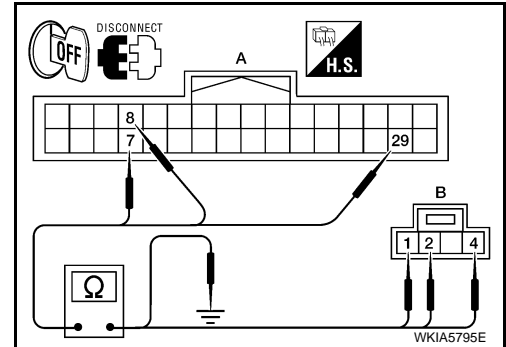

4. Check continuity between Bluetooth control unit harness connector B55 (A) and ground.

A		—	Continuity
Connector	Terminal		
B55	7	Ground	No
	8		
	29		

Are the continuity test results as specified?

- YES >> GO TO 2  
NO >> Repair harness or connector.

#### 2. CHECK MICROPHONE POWER SUPPLY

1. Connect Bluetooth control unit connector and microphone connector.
2. Turn ignition switch ON.
3. Check voltage between microphone harness connector R7 terminal 4 and ground.

**4 - Ground : Approx. 5V**

Is voltage reading approx. 5 volts?

- YES >> GO TO 3  
NO >> Replace Bluetooth control unit. Refer to [AV-227](#), "[Removal and Installation - Coupe](#)".

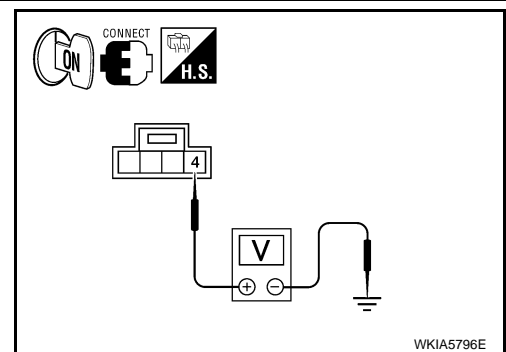

#### 3. CHECK MICROPHONE SIGNAL



# MICROPHONE SIGNAL CIRCUIT (COUPE)

[BOSE AUDIO WITHOUT NAVIGATION]

< COMPONENT DIAGNOSIS >

Check signal between Bluetooth control unit harness connector B55 terminals 7 and 8.

7 - 8:

When giving a voice

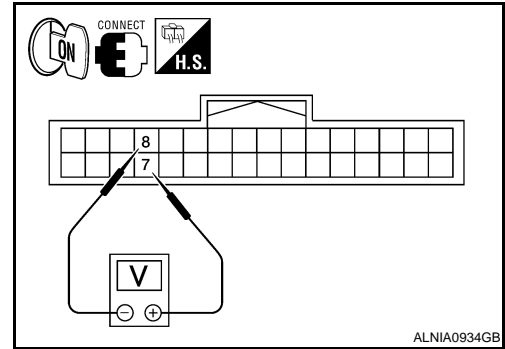
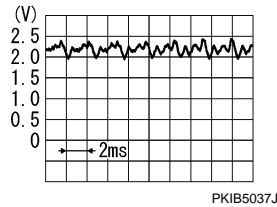

Are voltage readings as specified?

- YES >> Replace Bluetooth control unit. Refer to [AV-227. "Removal and Installation - Coupe"](#).
- NO >> Replace microphone. Refer to [AV-224. "Removal and Installation - Coupe"](#).

A  
B  
C  
D  
E  
F  
G  
H  
I  
J  
K  
L  
M  
O  
P

AV

# MICROPHONE SIGNAL CIRCUIT (SEDAN)

< COMPONENT DIAGNOSIS >

[BOSE AUDIO WITHOUT NAVIGATION]

## MICROPHONE SIGNAL CIRCUIT (SEDAN)

### Description

INFOID:00000000322190

Voice signals are transmitted from the microphone to the Bluetooth control unit using the microphone signal circuits.

### Diagnosis Procedure

INFOID:00000000322191

#### 1. CHECK HARNESS BETWEEN BLUETOOTH CONTROL UNIT AND MICROPHONE

1. Turn ignition switch OFF.
2. Disconnect Bluetooth control unit connector and microphone connector.
3. Check continuity between Bluetooth control unit harness connector B126 (A) and microphone harness connector R7 (B).

A		B		Continuity
Connector	Terminal	Connector	Terminal	
B126	7	R7	1	Yes
	8		2	
	29		4	

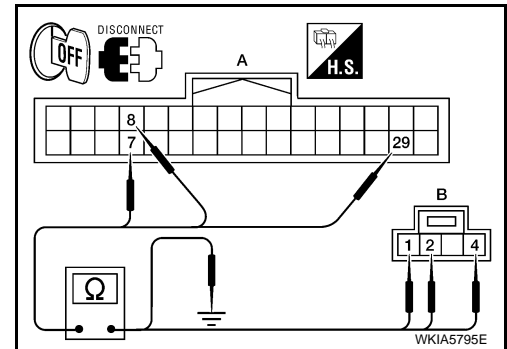

4. Check continuity between Bluetooth control unit harness connector B126 (A) and ground.

A		—	Continuity
Connector	Terminal		
B126	7	Ground	No
	8		
	29		

Are the continuity test results as specified?

- YES >> GO TO 2  
NO >> Repair harness or connector.

#### 2. CHECK MICROPHONE POWER SUPPLY

1. Connect Bluetooth control unit connector and microphone connector.
2. Turn ignition switch ON.
3. Check voltage between microphone harness connector R7 terminal 4 and ground.

**4 - Ground : Approx. 5V**

Is voltage reading approx. 5 volts?

- YES >> GO TO 3  
NO >> Replace Bluetooth control unit. Refer to [AV-227](#),  
["Removal and Installation - Sedan"](#).

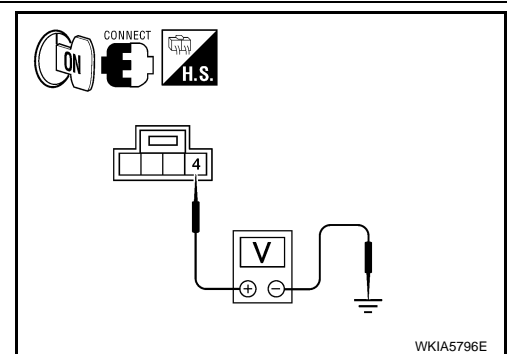

#### 3. CHECK MICROPHONE SIGNAL

# MICROPHONE SIGNAL CIRCUIT (SEDAN)

[BOSE AUDIO WITHOUT NAVIGATION]

< COMPONENT DIAGNOSIS >

Check signal between Bluetooth control unit harness connector B126 terminals 7 and 8.

7 - 8:

When giving a voice

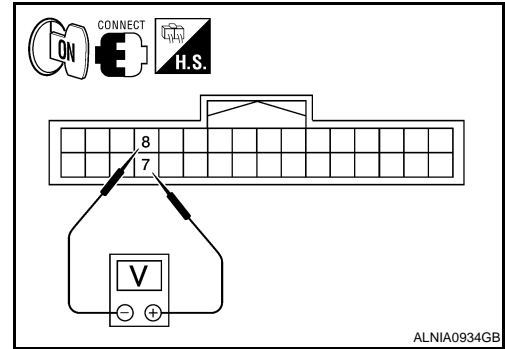
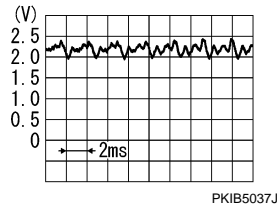

Are voltage readings as specified?

- YES >> Replace Bluetooth control unit. Refer to [AV-227. "Removal and Installation - Sedan"](#).
- NO >> Replace microphone. Refer to [AV-224. "Removal and Installation - Sedan"](#).

A  
B  
C  
D  
E  
F  
G  
H  
I  
J  
K  
L  
M  
O  
P

AV

# AUDIO UNIT (COUPE)

[BOSE AUDIO WITHOUT NAVIGATION]

< ECU DIAGNOSIS >

## ECU DIAGNOSIS

### AUDIO UNIT (COUPE)

Reference Value

INFOID:000000001830636

#### TERMINAL LAYOUT

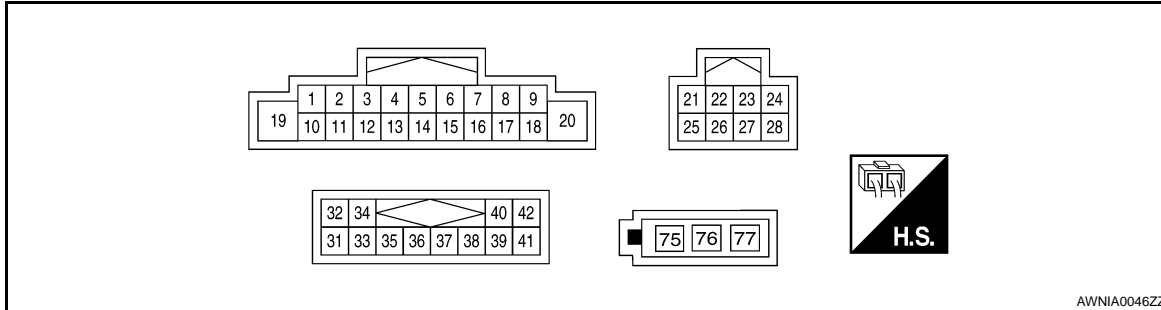



#### PHYSICAL VALUES - WITH BLUETOOTH

Terminal (Wire color)		Item	Signal in- put/out- put	Condition		Reference value
+	-			Ignition switch	Operation	
1 (B/P)	Ground	Amp. ON sig- nal	Output	ON	-	More than approx. 6.5V
2 (G)	3 (R)	Audio sound signal front LH	Output	ON	Receive audio sig- nal	<p>SKIA0177E</p>
4 (GR/V)	5 (W/L)	Audio sound signal rear LH	Output	ON	Receive audio sig- nal	<p>SKIA0177E</p>
6 (W/G)	Ground	Remote con- trol A	Input	ON	Press SEEK DOWN switch.	0.7 V
					Press SEEK UP switch.	1.3 V
					Press  switch.	2.0 V
					Except for above.	3.3 V
7 (V/Y)	Ground	ACC signal	Input	ON	Ignition switch ACC or ON	Battery voltage
10	-	Shield	-	-	-	Approx. 0V

# AUDIO UNIT (COUPE)

[BOSE AUDIO WITHOUT NAVIGATION]

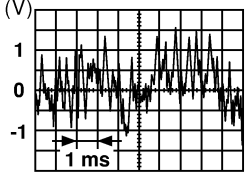
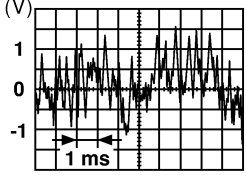
< ECU DIAGNOSIS >

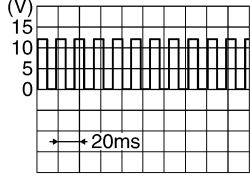
Terminal (Wire color)		Item	Signal input/output	Condition		Reference value
+	-			Ignition switch	Operation	
11 (B)	12 (W)	Audio sound signal front RH	Output	ON	Receive audio signal	 <p style="text-align: right; font-size: small;">SKIA0177E</p>
13 (V)	14 (LG)	Audio sound signal rear RH	Output	ON	Receive audio signal	 <p style="text-align: right; font-size: small;">SKIA0177E</p>
15 (L/B)	-	Remote control ground	Input	-	-	-
16 (GR/L)	Ground	Remote control B	Input	ON	Press SOURCE switch.	0 V
					Press  switch.	0.7 V
					Press VOL UP switch.	1.3 V
					Press VOL DOWN switch	2 V
					Except for above.	3.3 V
18 (V/W)	Ground	Vehicle speed signal (8-pulse)	Input	ON	When vehicle speed is approx. 40 km/h (25 MPH)	 <p style="text-align: right; font-size: small;">PKIA1935E</p>
19 (Y/R)	Ground	Battery power	Input	-	-	Battery voltage
20	-	Shield	-	-	-	Approx. 0V
21 (L)	-	M-CAN +	-	-	-	-
22 (P)	-	M-CAN -	-	-	-	-
23	-	Shield	-	-	-	Approx. 0V
25	-	Tel. Shield	-	-	-	Approx. 0V
26 (B/R)	27 (Y)	Telephone audio in	-	-	-	-
28 (R/W)	Ground	Telephone ON signal	Input	ON	-	-

A  
B  
C  
D  
E  
F  
G  
H  
I  
J  
K  
L  
M  
P

AV

# AUDIO UNIT (COUPE)

[BOSE AUDIO WITHOUT NAVIGATION]

< ECU DIAGNOSIS >

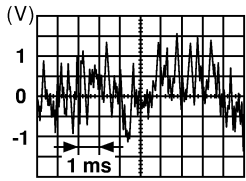
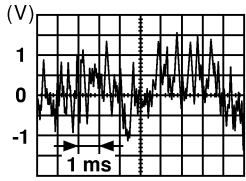
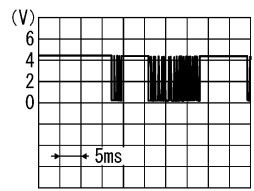
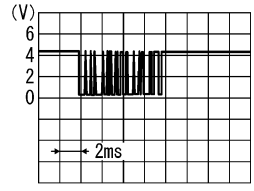
Terminal (Wire color)		Item	Signal in- put/out- put	Condition		Reference value
+	-			Ignition switch	Operation	
32 (Y/L)	31 (W/L)	Audio left channel sound signal from satellite radio tuner	Input	ON	Receive audio sig- nal	 <p style="text-align: right; font-size: small;">SKIA0177E</p>
34 (BR/L)	33 (Y/G)	Audio right channel sound signal from satellite radio tuner	Input	ON	Receive audio sig- nal	 <p style="text-align: right; font-size: small;">SKIA0177E</p>
35	-	Shield ground (audio signal)	-	-	-	0V
36	-	Shield ground (data)	-	-	-	0V
38 (R)	Ground	Satellite radio tuner request to audio unit	Input	ON	Turn audio unit ON	5V
39 (G)	Ground	Audio RX	Input		Operate audio vol- ume	 <p style="text-align: right; font-size: small;">SKIA4403E</p>
40 (B)	Ground	Audio TX	Output		Operate audio vol- ume	 <p style="text-align: right; font-size: small;">SKIA4402E</p>
75 (B)	Ground	Antenna amp power supply	Output	ON	Turn audio unit ON	Battery voltage
76 (B)	Ground	Main antenna	Input	ON	Turn audio unit ON	-

PHYSICAL VALUES - WITHOUT BLUETOOTH

# AUDIO UNIT (COUPE)

[BOSE AUDIO WITHOUT NAVIGATION]

< ECU DIAGNOSIS >

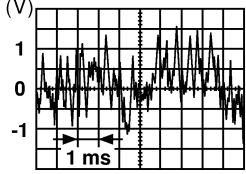
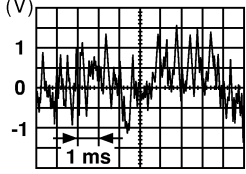
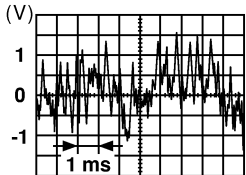
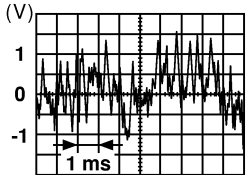
Terminal (Wire color)		Item	Signal input/output	Condition		Reference value
+	-			Ignition switch	Operation	
1 (B/P)	Ground	Amp. ON signal	Output	ON	-	More than approx. 6.5V
2 (G)	3 (R)	Audio sound signal front LH	Output	ON	Receive audio signal	 SKIA0177E
4 (GR/V)	5 (W/L)	Audio sound signal rear LH	Output	ON	Receive audio signal	 SKIA0177E
6 (W/G)	Ground	Remote control A	Input	ON	Press SOURCE switch.	0.0 V
					Press SEEK UP switch.	0.75 V
					Press VOL UP switch.	2.0 V
					Except for above.	5.0 V
7 (V/Y)	Ground	ACC signal	Input	ON	Ignition switch ACC or ON	Battery voltage
10	-	Shield	-	-	-	Approx. 0V
11 (B)	12 (W)	Audio sound signal front RH	Output	ON	Receive audio signal	 SKIA0177E
13 (V)	14 (LG)	Audio sound signal rear RH	Output	ON	Receive audio signal	 SKIA0177E
15 (L/B)	-	Remote control ground	Input	-	-	-
16 (GR/L)	Ground	Remote control B	Input	ON	Press SEEK DOWN switch.	0.75 V
					Press VOL DOWN switch.	2.0 V
					Except for above.	5.0 V

A  
B  
C  
D  
E  
F  
G  
H  
I  
J  
K  
L  
M  
P

AV

# AUDIO UNIT (COUPE)

[BOSE AUDIO WITHOUT NAVIGATION]

< ECU DIAGNOSIS >

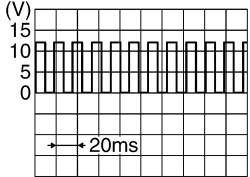
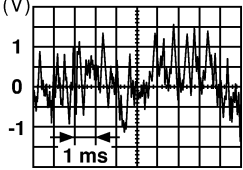
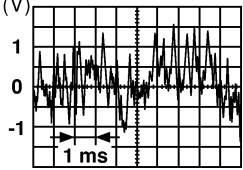
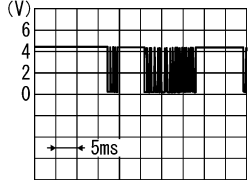
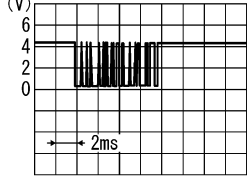
Terminal (Wire color)		Item	Signal in- put/out- put	Condition		Reference value
+	-			Ignition switch	Operation	
18 (V/W)	Ground	Vehicle speed signal (8- pulse)	Input	ON	When vehicle speed is approx. 40 km/h (25 MPH)	 <p style="text-align: right; font-size: small;">PKIA1935E</p>
19 (Y/R)	Ground	Battery power	Input	-	-	Battery voltage
20	-	Shield	-	-	-	Approx. 0V
32 (Y/L)	31 (W/L)	Audio left channel sound signal from satellite radio tuner	Input	ON	Receive audio sig- nal	 <p style="text-align: right; font-size: small;">SKIA0177E</p>
34 (BR/L)	33 (Y/G)	Audio right channel sound signal from satellite radio tuner	Input	ON	Receive audio sig- nal	 <p style="text-align: right; font-size: small;">SKIA0177E</p>
35	-	Shield ground (audio signal)	-	-	-	0V
36	-	Shield ground (data)	-	-	-	0V
38 (R)	Ground	Satellite radio tuner request to audio unit	Input		Turn audio unit ON	5V
39 (G)	Ground	Audio RX	Input	ON	Operate audio vol- ume	 <p style="text-align: right; font-size: small;">SKIA4403E</p>
40 (B)	Ground	Audio TX	Output		Operate audio vol- ume	 <p style="text-align: right; font-size: small;">SKIA4402E</p>
75 (B)	Ground	Antenna amp power supply	Output	ON	Turn audio unit ON	Battery voltage
76 (B)	Ground	Main antenna	Input	ON	Turn audio unit ON	-





# AUDIO UNIT (COUPE)

[BOSE AUDIO WITHOUT NAVIGATION]

< ECU DIAGNOSIS >

◁ BB ▷ : WITH BLUETOOTH  
 ▷ NB ▷ : WITHOUT BLUETOOTH

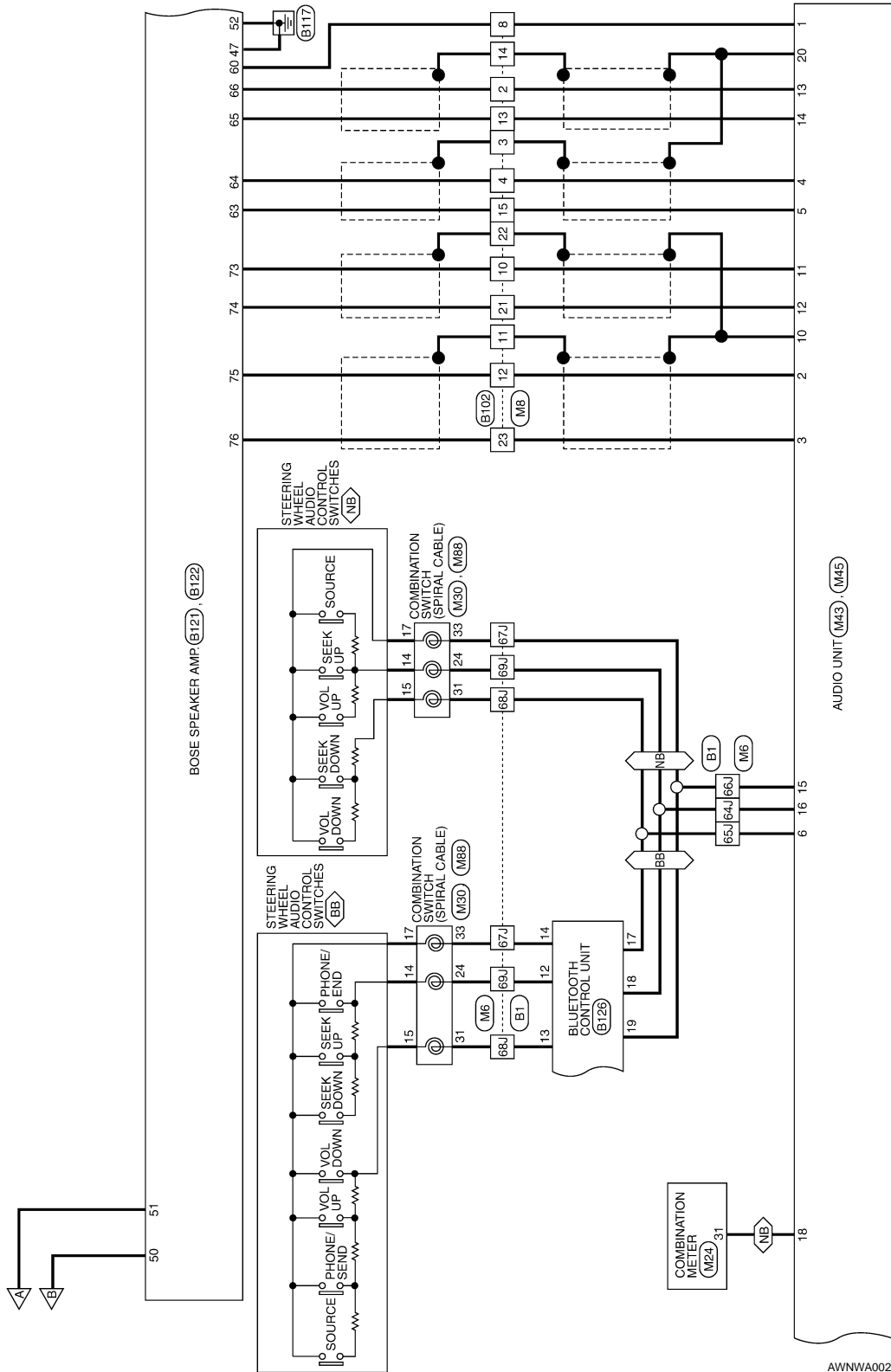

AWNWA0020G

# AUDIO UNIT (COUPE)

[BOSE AUDIO WITHOUT NAVIGATION]

< ECU DIAGNOSIS >

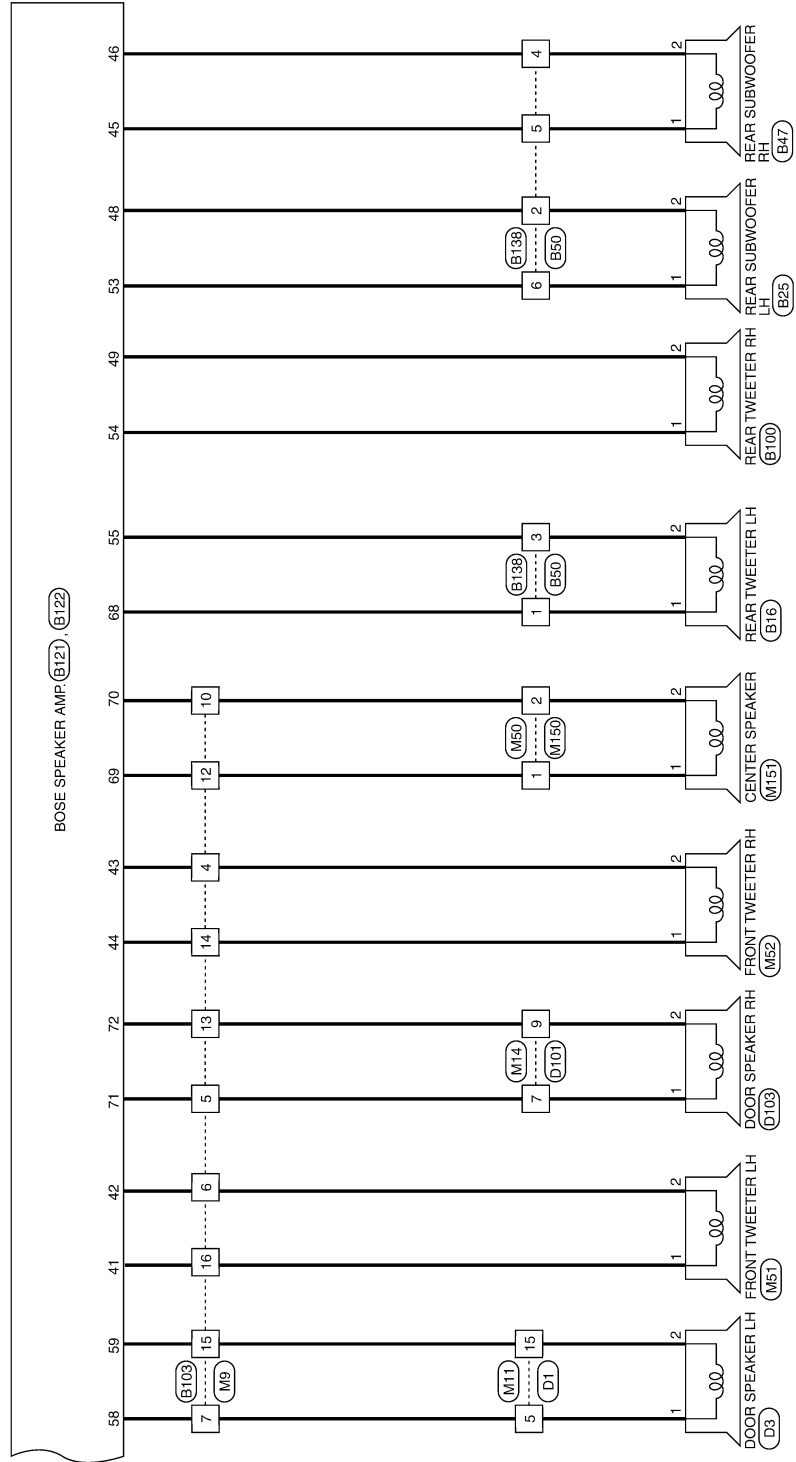

AWNWA0021G

A  
B  
C  
D  
E  
F  
G  
H  
I  
J  
K  
L  
M  
AV  
O  
P

# AUDIO UNIT (COUPE)

[BOSE AUDIO WITHOUT NAVIGATION]

< ECU DIAGNOSIS >

## BOSE AUDIO WITHOUT NAVIGATION CONNECTORS

Connector No.	M1
Connector Name	WIRE TO WIRE
Connector Color	WHITE

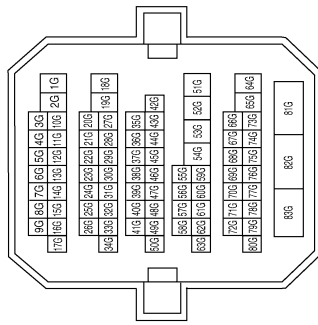

# AUDIO UNIT (COUPE)

[BOSE AUDIO WITHOUT NAVIGATION]

< ECU DIAGNOSIS >

Terminal No.	Color of Wire	Signal Name
12	G	-
13	LG	-
14	SHIELD	-
15	W/L	-
21	W	-
22	SHIELD	-
23	R	-

Connector No.	M8
Connector Name	WIRE TO WIRE
Connector Color	WHITE

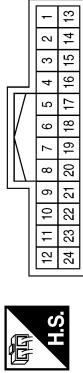

Terminal No.	Color of Wire	Signal Name
2	V	-
3	SHIELD	-
4	GR/V	-
8	B/P	-
10	B	-
11	SHIELD	-

Connector No.	M7
Connector Name	WIRE TO WIRE
Connector Color	WHITE

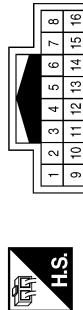

Terminal No.	Color of Wire	Signal Name
1	B/R	-
2	R/B	-
3	R/L	-
4	SHIELD	-
7	Y/R	-
13	BR/W	-

Connector No.	M11
Connector Name	WIRE TO WIRE
Connector Color	WHITE

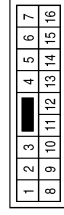

Terminal No.	Color of Wire	Signal Name
5	W	-
15	B	-

Terminal No.	Color of Wire	Signal Name
1	BR	-
4	GR/L	-
5	G/W	-
6	B/Y	-
7	W	-
9	B/R	-
10	O/B	-
12	B/P	-
13	BR	-
14	L/O	-
15	B	-
16	LG	-

Connector No.	M9
Connector Name	WIRE TO WIRE
Connector Color	BROWN

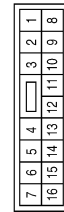

AWNIA0333GB

A  
B  
C  
D  
E  
F  
G  
H  
I  
J  
K  
L  
M  
AV  
O  
P

# AUDIO UNIT (COUPE)

[BOSE AUDIO WITHOUT NAVIGATION]

< ECU DIAGNOSIS >

Connector No.	M14
Connector Name	WIRE TO WIRE
Connector Color	WHITE

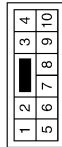

Terminal No.	Color of Wire	Signal Name
7	GW	-
9	BR	-

Connector No.	M24
Connector Name	COMBINATION METER
Connector Color	WHITE

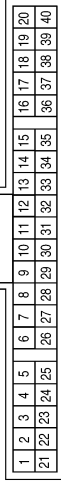

Terminal No.	Color of Wire	Signal Name
31	V/W	8P/R OUT

Connector No.	M30
Connector Name	COMBINATION SWITCH (SPIRAL CABLE)
Connector Color	GRAY

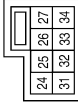

Terminal No.	Color of Wire	Signal Name
24	W/G	AUDIO_STRG_SW_REMOTE_A
31	GR/L	AUDIO_STRG_SW_REMOTE_B
33	L/B	AUDIO_STRG_SW_GND

Connector No.	M43
Connector Name	AUDIO UNIT
Connector Color	WHITE

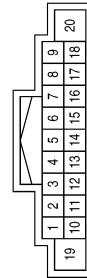

Terminal No.	Color of Wire	Signal Name
1	B/P	AMP_ON
2	G	FR SP LH (+)
3	R	FR SP LH (-)
4	GR/V	RR SP LH (+)
5	W/L	RR SP LH (-)

Terminal No.	Color of Wire	Signal Name
6	W/G	STRG_SW_A
7	V/Y	ACC
8	-	-
9	-	-
10	SHIELD	-
11	B	FR SP RH (+)
12	W	FR SP RH (-)
13	V	RR SP RH (+)
14	LG	RR SP RH (-)
15	L/B	STRG_SW_GND
16	GR/L	STRG_SW_B
17	-	-
18	V/W	SPEED SIGNAL
19	Y/R	BAT
20	SHIELD	-

Connector No.	M44
Connector Name	AUDIO UNIT
Connector Color	WHITE

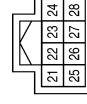

Terminal No.	Color of Wire	Signal Name
21	L	M-CAN +
22	P	M-CAN -
23	SHIELD	-
24	-	-
25	SHIELD	-
26	B/R	TEL I/F +
27	Y	TEL I/F -
28	R/W	TEL ON

AWNIA0334GB

# AUDIO UNIT (COUPE)

[BOSE AUDIO WITHOUT NAVIGATION]

< ECU DIAGNOSIS >

Connector No.	M50
Connector Name	WIRE TO WIRE
Connector Color	WHITE



Terminal No.	Color of Wire	Signal Name
1	B/P	-
2	O/B	-

Terminal No.	Color of Wire	Signal Name
31	W/L	SAT LH INPUT (-)
32	Y/L	SAT LH INPUT (+)
33	Y/G	SAT RH INPUT (-)
34	BR/L	SAT RH INPUT (+)
35	SHIELD	EARTH
36	SHIELD	DAT EARTH
37	-	-
38	R	RFQ1 (SAT TO COMBI)
39	G	RX (SAT TO COMBI)
40	B	TX (COMBI TO SAT)
41	-	-
42	-	-

Connector No.	M45
Connector Name	AUDIO UNIT
Connector Color	WHITE



Connector No.	M81
Connector Name	AUDIO UNIT
Connector Color	GRAY



Terminal No.	Color of Wire	Signal Name
75	B	AMP SUPPLY
76	B	MAIN ANTENNA
77	-	-

Connector No.	M52
Connector Name	FRONT TWEETER RH
Connector Color	BROWN



Terminal No.	Color of Wire	Signal Name
1	L/O	-
2	GR/L	-

Connector No.	M51
Connector Name	FRONT TWEETER LH
Connector Color	BROWN



Terminal No.	Color of Wire	Signal Name
1	LG	-
2	B/Y	-

AWNIA0335GB

A  
B  
C  
D  
E  
F  
G  
H  
I  
J  
K  
L  
M  
N  
O  
P

AV

# AUDIO UNIT (COUPE)

[BOSE AUDIO WITHOUT NAVIGATION]

< ECU DIAGNOSIS >

Connector No.	M150
Connector Name	WIRE TO WIRE
Connector Color	WHITE



Terminal No.	Color of Wire	Signal Name
1	B/P	-
2	O/B	-

Connector No.	M88
Connector Name	COMBINATION SWITCH (SPIRAL CABLE)
Connector Color	GRAY

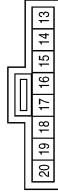

Terminal No.	Color of Wire	Signal Name
14	W	REMOTE A
15	L	REMOTE B
17	BR	GND

Connector No.	M87
Connector Name	WIRE TO WIRE
Connector Color	GRAY

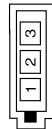

Terminal No.	Color of Wire	Signal Name
1	B	-
2	B	-

Connector No.	M502
Connector Name	ANTENNA AMP
Connector Color	GRAY



Terminal No.	Color of Wire	Signal Name
1	B	-
2	B	-

Connector No.	M501
Connector Name	WIRE TO WIRE
Connector Color	GRAY



Terminal No.	Color of Wire	Signal Name
1	B	-
2	B	-

Connector No.	M151
Connector Name	CENTER SPEAKER
Connector Color	BROWN



Terminal No.	Color of Wire	Signal Name
1	B/P	-
2	O/B	-

AWNIA0336GB



# AUDIO UNIT (COUPE)

[BOSE AUDIO WITHOUT NAVIGATION]

< ECU DIAGNOSIS >

Terminal No.	Color of Wire	Signal Name
53G	B/R	-
54G	BR	-
64G	Y/R	-

Connector No.	E30
Connector Name	WIRE TO WIRE
Connector Color	WHITE

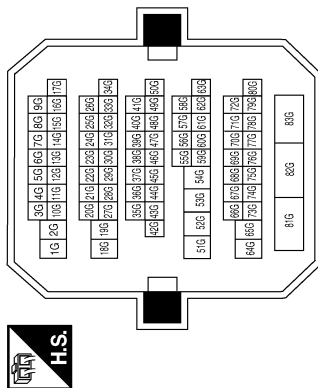

Terminal No.	Color of Wire	Signal Name
31J	Y/B	-
32J	SHIELD	-
33J	Y	-
34J	BR	-
35J	SHIELD	-
36J	B/W	-
37J	L	-
38J	R/W	-
39J	V/W	-
41J	R/L	-
42J	R/B	-
43J	B/R	-
44J	SHIELD	-
45J	G	-
46J	V/Y	-
49J	SHIELD	-

Connector No.	B1
Connector Name	WIRE TO WIRE
Connector Color	WHITE

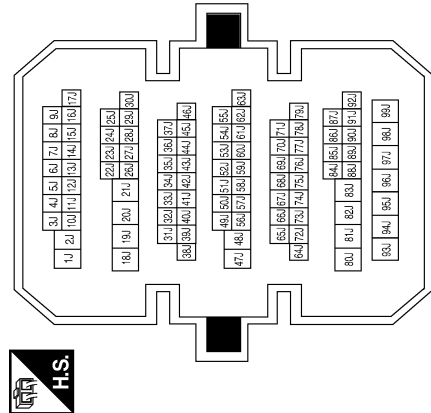

Terminal No.	Color of Wire	Signal Name
50J	BR/L	-
51J	Y/G	-
52J	Y/L	-
53J	W/L	-
54J	V/Y	-
55J	Y/R	-
60J	SHIELD	-
61J	B	-
62J	G	-
63J	R	-
64J	GR/L	-
65J	W/G	-
66J	L/B	-
67J	L/B	-
68J	GR/L	-
69J	W/G	-

AWNIA0337GB

A  
B  
C  
D  
E  
F  
G  
H  
I  
J  
K  
L  
M  
N  
O  
P

AV

# AUDIO UNIT (COUPE)

[BOSE AUDIO WITHOUT NAVIGATION]

< ECU DIAGNOSIS >

Connector No.	B47
Connector Name	REAR SUBWOOFER RH
Connector Color	WHITE



Terminal No.	Color of Wire	Signal Name
1	BR/W	-
2	BR	-

Connector No.	B25
Connector Name	REAR SUBWOOFER LH
Connector Color	WHITE



Terminal No.	Color of Wire	Signal Name
1	W/B	-
2	G/B	-

Connector No.	B16
Connector Name	REAR TWEETER LH
Connector Color	BROWN



Terminal No.	Color of Wire	Signal Name
1	LG	-
2	B/Y	-

Terminal No.	Color of Wire	Signal Name
7	B/R	MIC_IN_+
8	R/B	MIC_IN_-
9	BR	AUDIO_OUT(+)
10	Y	AUDIO_OUT(-)
11	G/O	MUTE_CONTROL
12	W/G	LAD_IN1
13	GR/L	LAD_IN2
14	L/B	LAD_GND
15	BR/W	IND1
17	W/G	LAD_OUT_1
18	GR/L	LAD_OUT_2
19	L/B	LAD_GND
24	B/W	CONT5
28	V/W	SPEED SIGNAL
29	R/L	MIC_POWER

Connector No.	B55
Connector Name	BLUETOOTH CONTROL UNIT
Connector Color	WHITE

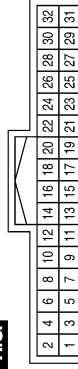

Terminal No.	Color of Wire	Signal Name
1	Y/B	BAT
2	V/Y	ACC
3	G/W	IGN
4	B/W	GND
6	SHIELD	-

Connector No.	B50
Connector Name	WIRE TO WIRE
Connector Color	WHITE



Terminal No.	Color of Wire	Signal Name
1	R/G	-
2	G/B	-
3	BR/B	-
4	BR	-
5	BR/W	-
6	W/B	-

AWNIA0338GB

# AUDIO UNIT (COUPE)

[BOSE AUDIO WITHOUT NAVIGATION]

< ECU DIAGNOSIS >

Connector No.	B56
Connector Name	BLUETOOTH CONTROL UNIT
Connector Color	WHITE

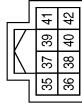

Connector No.	B57
Connector Name	SATELLITE RADIO TUNER OR PRE-WIRING FOR SATELLITE RADIO TUNER
Connector Color	WHITE

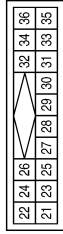

Terminal No.	Color of Wire	Signal Name
35	L	M-CAN +_1
36	P	M-CAN -_2
37	SHIELD	M-CAN_SHIELD_1
39	Y/R	M-CAN_JUMPER 1
40	Y/R	M-CAN+_2
41	SB	M-CAN_JUMPER 1
42	SB	M-CAN -_2

Terminal No.	Color of Wire	Signal Name
21	W/L	SAT_LCH (-)
22	Y/L	SAT_LCH (+)
23	Y/G	SAT_RCH (-)
24	BR/L	SAT_RCH (+)
25	SHIELD	EARTH (SIG)
26	SHIELD	DATA
27	-	-
28	R/L	REQ1 (SAT - COMBI)
29	R/W	TXD (SAT_COMBI)
30	B	FXD (COMBI_SAT)
31	-	-
32	Y/R	BAT
33	-	-
34	-	-
35	-	-
36	GR/W	ACC

Connector No.	B58
Connector Name	SATELLITE RADIO TUNER OR PRE-WIRING FOR SATELLITE RADIO TUNER
Connector Color	BROWN (WITH SIRIUS SATELLITE TUNER) VIOLET (WITH XM SATELLITE RADIO)



Connector No.	B59
Connector Name	SATELLITE RADIO ANTENNA
Connector Color	GRAY (WITH SIRIUS SATELLITE TUNER) BROWN (WITH XM SATELLITE RADIO)



Connector No.	B100
Connector Name	REAR TWEETER RH
Connector Color	BROWN



Terminal No.	Color of Wire	Signal Name
37	B	ANTENNA SIGNAL

Terminal No.	Color of Wire	Signal Name
1	B	-

Terminal No.	Color of Wire	Signal Name
1	L/O	-
2	GR/L	-

AWNIA0339GB

A  
B  
C  
D  
E  
F  
G  
H  
I  
J  
K  
L  
M  
N  
O  
P

# AUDIO UNIT (COUPE)

[BOSE AUDIO WITHOUT NAVIGATION]

< ECU DIAGNOSIS >

Terminal No.	Color of Wire	Signal Name
13	V	-
14	SHIELD	-
15	Y	-
18	GR/L	-
19	L/B	-
21	GR/V	-
22	SHIELD	-
23	B/R	-

Terminal No.	Color of Wire	Signal Name
2	LG	-
3	SHIELD	-
4	BR	-
6	W/G	-
8	B/G	-
10	W/L	-
11	SHIELD	-
12	W/R	-

Connector No.	B102
Connector Name	WIRE TO WIRE
Connector Color	WHITE



Connector No.	B106
Connector Name	WIRE TO WIRE
Connector Color	WHITE



Terminal No.	Color of Wire	Signal Name
1	L	-
5	B/W	-

Terminal No.	Color of Wire	Signal Name
7	W	-
9	B/R	-
10	O/B	-
11	R/G	-
12	B/P	-
13	BR	-
14	L/O	-
15	B	-
16	LG	-

Connector No.	B103
Connector Name	WIRE TO WIRE
Connector Color	BROWN

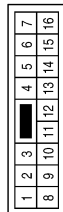

Terminal No.	Color of Wire	Signal Name
1	BR	-
3	BR/B	-
4	GR/L	-
5	G/W	-
6	B/Y	-

AWNIA0340GB

# AUDIO UNIT (COUPE)

[BOSE AUDIO WITHOUT NAVIGATION]

< ECU DIAGNOSIS >

Connector No.	B138
Connector Name	WIRE TO WIRE
Connector Color	WHITE



Terminal No.	Color of Wire	Signal Name
1	R/G	-
2	G/B	-
3	BR/B	-
4	BR	-
5	BR/W	-
6	W/B	-

Connector No.	B122
Connector Name	BOSE SPEAKER AMP
Connector Color	BROWN

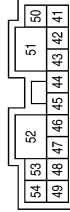

Terminal No.	Color of Wire	Signal Name
41	LG	FR TWDR LH + OUT
42	B/Y	FR TWDR LH - OUT
43	GR/L	FR TWDR RH - OUT
44	L/O	FR TWDR RH + OUT
45	BR/W	RH WOOFER + OUT
46	BR	RH WOOFER - OUT
47	B/W	GND
48	G/B	LH WOOFER - OUT
49	B/W	TWTR RR PSHELF RH - OUT
50	BR	BAT
51	B/R	BAT
52	B/W	GND
53	W/B	LH WOOFER + OUT
54	L	TWTR RR PSHELF RH + OUT

Connector No.	B121
Connector Name	BOSE SPEAKER AMP
Connector Color	BROWN

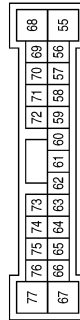

Terminal No.	Color of Wire	Signal Name
55	BR/B	TWTR RR PSHELF LH - OUT
58	W	RR DOOR LH + OUT
59	B	FR DOOR LH - OUT
60	B/G	AMP ON
63	Y	RR LH - IN
64	BR	RR LH + IN
65	V	RR RH - IN
66	LG	RR RH + IN
68	R/G	TWTR RR PSHELF LH + OUT
69	B/P	INST CTR TWDR + OUT
70	O/B	INST CTR TWDR - OUT
71	G/W	FR DOOR RH + OUT
72	BR	FR DOOR RH - OUT
73	W/L	FR RH + IN
74	GR/V	FR RH - IN
75	W/R	FR LH + IN
76	B/R	FR LH - IN

AWNIA0341GB

A  
B  
C  
D  
E  
F  
G  
H  
I  
J  
K  
L  
M  
O  
P

AV

# AUDIO UNIT (COUPE)

[BOSE AUDIO WITHOUT NAVIGATION]

< ECU DIAGNOSIS >

Connector No.	D1
Connector Name	WIRE TO WIRE
Connector Color	WHITE

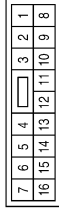

Terminal No.	Color of Wire	Signal Name
5	W	-
15	B	-

Connector No.	R7
Connector Name	MICROPHONE
Connector Color	WHITE

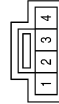

Terminal No.	Color of Wire	Signal Name
1	W	SIG
2	R	GND
4	B	VCC

Connector No.	R1
Connector Name	WIRE TO WIRE
Connector Color	WHITE

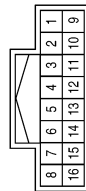

Terminal No.	Color of Wire	Signal Name
1	W	-
2	R	-
3	B	-
4	SHIELD	-

Connector No.	D103
Connector Name	DOOR SPEAKER RH
Connector Color	BROWN



Terminal No.	Color of Wire	Signal Name
1	G/W	-
2	BR	-

Connector No.	D101
Connector Name	WIRE TO WIRE
Connector Color	WHITE



Terminal No.	Color of Wire	Signal Name
7	G/W	-
9	BR	-

Connector No.	D3
Connector Name	DOOR SPEAKER LH
Connector Color	WHITE



Terminal No.	Color of Wire	Signal Name
1	W	-
2	B	-

AWNIA0342GB

# AUDIO UNIT (SEDAN)

[BOSE AUDIO WITHOUT NAVIGATION]

< ECU DIAGNOSIS >

## AUDIO UNIT (SEDAN)



Reference Value

INFOID:000000003222255

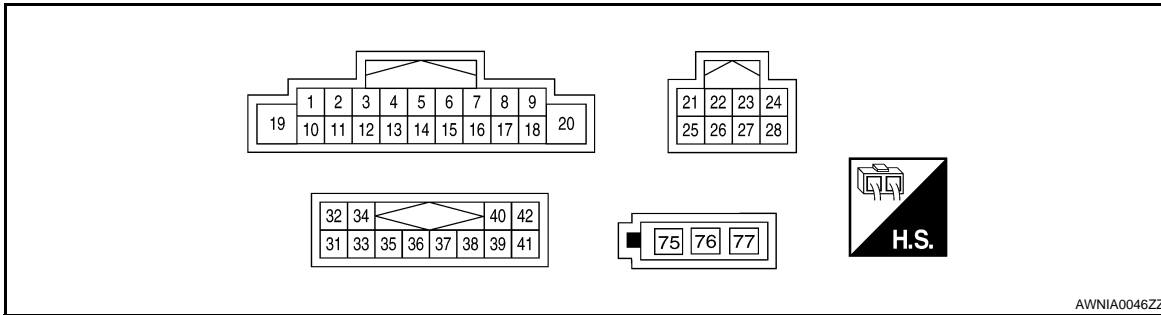
### TERMINAL LAYOUT



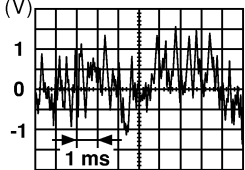
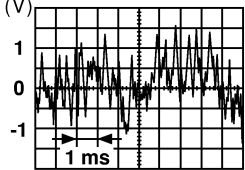

### PHYSICAL VALUES - WITH BLUETOOTH

Terminal (Wire color)		Item	Signal in- put/out- put	Condition		Reference value
+	-			Ignition switch	Operation	
1 (B/P)	Ground	Amp. ON sig- nal	Output	ON	-	More than approx. 6.5V
2 (G)	3 (R)	Audio sound signal front LH	Output	ON	Receive audio sig- nal	 SKIA0177E
4 (GR/V)	5 (W/L)	Audio sound signal rear LH	Output	ON	Receive audio sig- nal	 SKIA0177E
6 (W/G)	Ground	Remote con- trol A	Input	ON	Press SEEK DOWN switch.	0.7 V
					Press SEEK UP switch.	1.3 V
					Press  switch.	2.0 V
					Except for above.	3.3 V
7 (V/Y)	Ground	ACC signal	Input	ON	Ignition switch ACC or ON	Battery voltage
10	-	Shield	-	-	-	Approx. 0V

# AUDIO UNIT (SEDAN)

[BOSE AUDIO WITHOUT NAVIGATION]

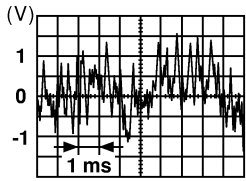
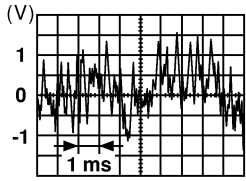
< ECU DIAGNOSIS >

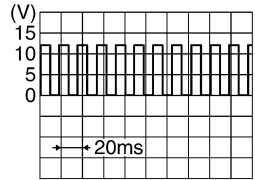
Terminal (Wire color)		Item	Signal in- put/out- put	Condition		Reference value
+	-			Ignition switch	Operation	
11 (B)	12 (W)	Audio sound signal front RH	Output	ON	Receive audio sig- nal	 <p style="text-align: right; font-size: small;">SKIA0177E</p>
13 (V)	14 (LG)	Audio sound signal rear RH	Output	ON	Receive audio sig- nal	 <p style="text-align: right; font-size: small;">SKIA0177E</p>
15 (L/B)	-	Remote con- trol ground	Input	-	-	-
16 (GR/L)	Ground	Remote con- trol B	Input	ON	Press SOURCE switch.	0 V
					Press  switch.	0.7 V
					Press VOL UP switch.	1.3 V
					Press VOL DOWN switch	2 V
					Except for above.	3.3 V
18 (V/W)	Ground	Vehicle speed signal (8- pulse)	Input	ON	When vehicle speed is approx. 40 km/h (25 MPH)	 <p style="text-align: right; font-size: small;">PKIA1935E</p>
19 (Y/R)	Ground	Battery power	Input	-	-	Battery voltage
20	-	Shield	-	-	-	Approx. 0V
21 (L)	-	M-CAN +	-	-	-	-
22 (P)	-	M-CAN -	-	-	-	-
23	-	Shield	-	-	-	Approx. 0V
25	-	Tel. Shield	-	-	-	Approx. 0V
26 (B/R)	27 (Y)	Telephone au- dio in	-	-	-	-
28 (R/W)	Ground	Telephone ON signal	Input	ON	-	-



# AUDIO UNIT (SEDAN)

[BOSE AUDIO WITHOUT NAVIGATION]

< ECU DIAGNOSIS >

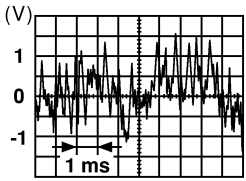
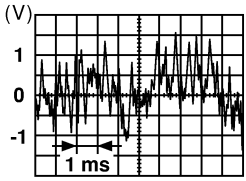
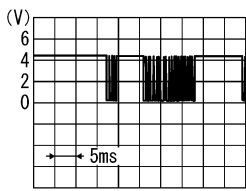
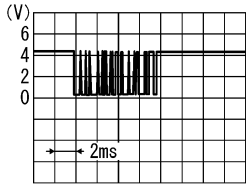
Terminal (Wire color)		Item	Signal in- put/out- put	Condition		Reference value
+	-			Ignition switch	Operation	
32 (Y/L)	31 (W/L)	Audio left channel sound signal from satellite radio tuner	Input	ON	Receive audio sig- nal	 <p style="text-align: right; font-size: small;">SKIA0177E</p>
34 (BR/L)	33 (Y/G)	Audio right channel sound signal from satellite radio tuner	Input	ON	Receive audio sig- nal	 <p style="text-align: right; font-size: small;">SKIA0177E</p>
35	-	Shield ground (audio signal)	-	-	-	0V
36	-	Shield ground (data)	-	-	-	0V
38 (R)	Ground	Satellite radio tuner request to audio unit	Input	ON	Turn audio unit ON	5V
39 (G)	Ground	Audio RX	Input		Operate audio vol- ume	 <p style="text-align: right; font-size: small;">SKIA4403E</p>
40 (B)	Ground	Audio TX	Output		Operate audio vol- ume	 <p style="text-align: right; font-size: small;">SKIA4402E</p>
75 (B)	Ground	Antenna amp power supply	Output	ON	Turn audio unit ON	Battery voltage
76 (B)	Ground	Main antenna	Input	ON	Turn audio unit ON	-

A  
B  
C  
D  
E  
F  
G  
H  
I  
J  
K  
L  
M  
AV  
O  
P

PHYSICAL VALUES - WITHOUT BLUETOOTH

# AUDIO UNIT (SEDAN)

[BOSE AUDIO WITHOUT NAVIGATION]

< ECU DIAGNOSIS >

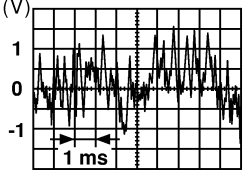
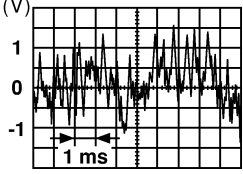
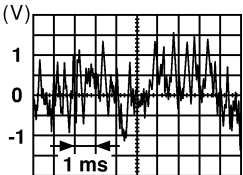
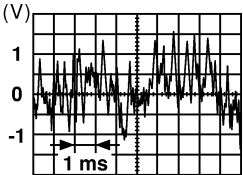
Terminal (Wire color)		Item	Signal in- put/out- put	Condition		Reference value
+	-			Ignition switch	Operation	
1 (B/P)	Ground	Amp. ON sig- nal	Output	ON	-	More than approx. 6.5V
2 (G)	3 (R)	Audio sound signal front LH	Output	ON	Receive audio sig- nal	
4 (GR/V)	5 (W/L)	Audio sound signal rear LH	Output	ON	Receive audio sig- nal	
6 (W/G)	Ground	Remote con- trol A	Input	ON	Press SOURCE switch.	0.0 V
					Press SEEK UP switch.	0.75 V
					Press VOL UP switch.	2.0 V
					Except for above.	5.0 V
7 (V/Y)	Ground	ACC signal	Input	ON	Ignition switch ACC or ON	Battery voltage
10	-	Shield	-	-	-	Approx. 0V
11 (B)	12 (W)	Audio sound signal front RH	Output	ON	Receive audio sig- nal	
13 (V)	14 (LG)	Audio sound signal rear RH	Output	ON	Receive audio sig- nal	
15 (L/B)	-	Remote con- trol ground	Input	-	-	-
16 (GR/L)	Ground	Remote con- trol B	Input	ON	Press SEEK DOWN switch.	0.75 V
					Press VOL DOWN switch.	2.0 V
					Except for above.	5.0 V

# AUDIO UNIT (SEDAN)

[BOSE AUDIO WITHOUT NAVIGATION]

< ECU DIAGNOSIS >

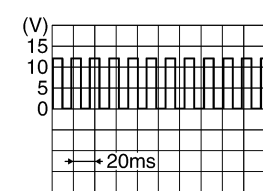
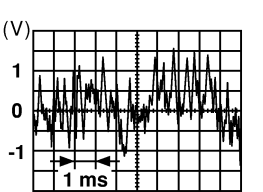
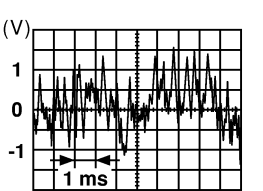
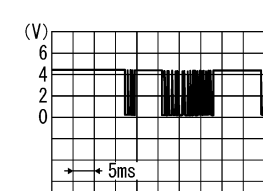
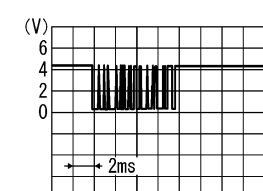
Terminal (Wire color)		Item	Signal in- put/out- put	Condition		Reference value
+	-			Ignition switch	Operation	
18 (V/W)	Ground	Vehicle speed signal (8- pulse)	Input	ON	When vehicle speed is approx. 40 km/h (25 MPH)	 <p style="text-align: right; font-size: small;">PKIA1935E</p>
19 (Y/R)	Ground	Battery power	Input	-	-	Battery voltage
20	-	Shield	-	-	-	Approx. 0V
32 (Y/L)	31 (W/L)	Audio left channel sound signal from satellite radio tuner	Input	ON	Receive audio sig- nal	 <p style="text-align: right; font-size: small;">SKIA0177E</p>
34 (BR/L)	33 (Y/G)	Audio right channel sound signal from satellite radio tuner	Input	ON	Receive audio sig- nal	 <p style="text-align: right; font-size: small;">SKIA0177E</p>
35	-	Shield ground (audio signal)	-	-	-	0V
36	-	Shield ground (data)	-	-	-	0V
38 (R)	Ground	Satellite radio tuner request to audio unit	Input	ON	Turn audio unit ON	5V
39 (G)	Ground	Audio RX	Input		Operate audio vol- ume	 <p style="text-align: right; font-size: small;">SKIA4403E</p>
40 (B)	Ground	Audio TX	Output		Operate audio vol- ume	 <p style="text-align: right; font-size: small;">SKIA4402E</p>
75 (B)	Ground	Antenna amp power supply	Output	ON	Turn audio unit ON	Battery voltage
76 (B)	Ground	Main antenna	Input	ON	Turn audio unit ON	-

A  
B  
C  
D  
E  
F  
G  
H  
I  
J  
K  
L  
M  
O  
P

AV



# AUDIO UNIT (SEDAN)

[BOSE AUDIO WITHOUT NAVIGATION]

< ECU DIAGNOSIS >

BB : WITH BLUETOOTH  
 NE : WITHOUT BLUETOOTH

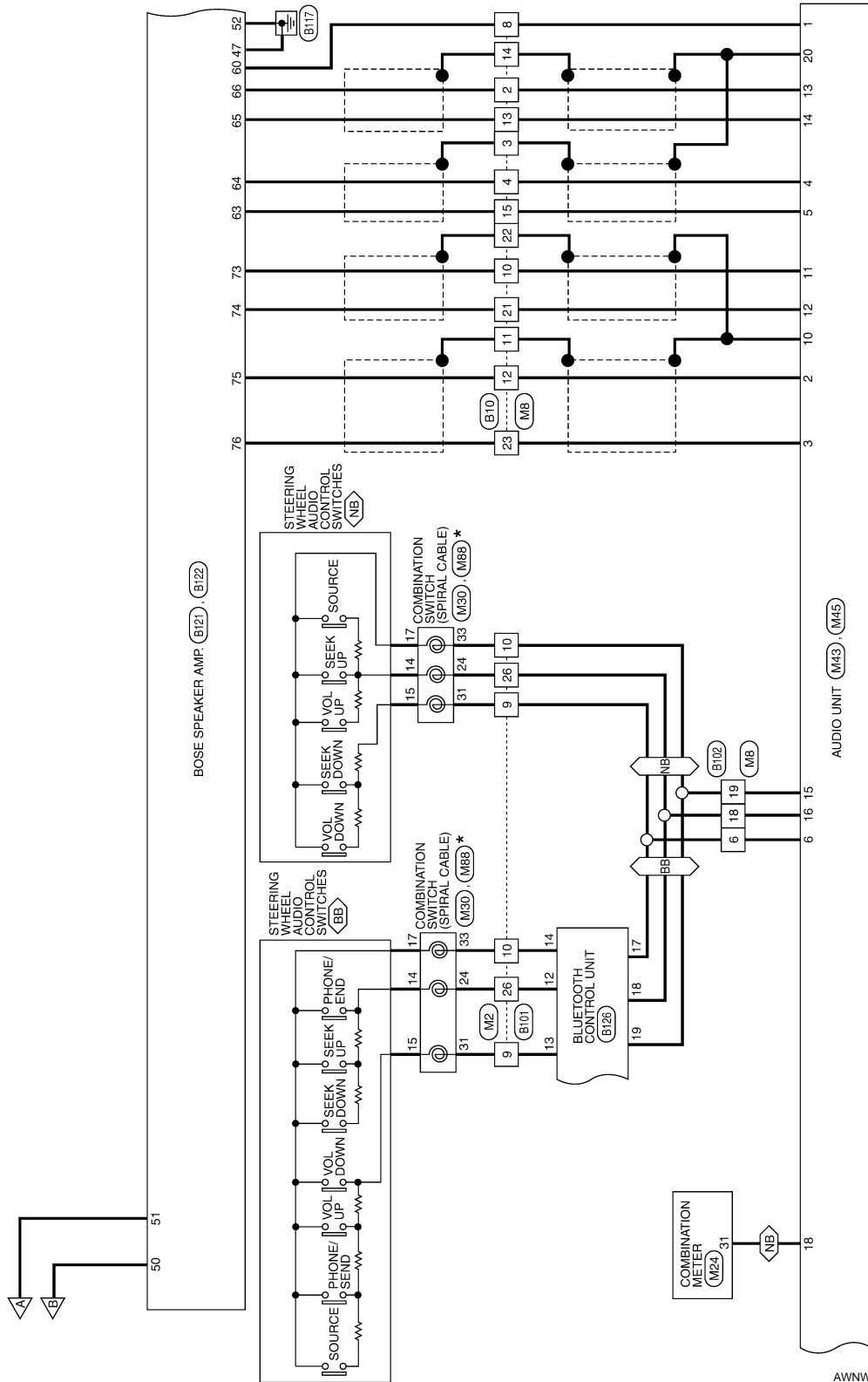

\* : THIS CONNECTOR IS NOT SHOWN IN "HARNES LAYOUT" OF PG SECTION

AWNWA0121G

A  
 B  
 C  
 D  
 E  
 F  
 G  
 H  
 I  
 J  
 K  
 L  
 M  
 N  
 O  
 P

AV

# AUDIO UNIT (SEDAN)

[BOSE AUDIO WITHOUT NAVIGATION]

< ECU DIAGNOSIS >

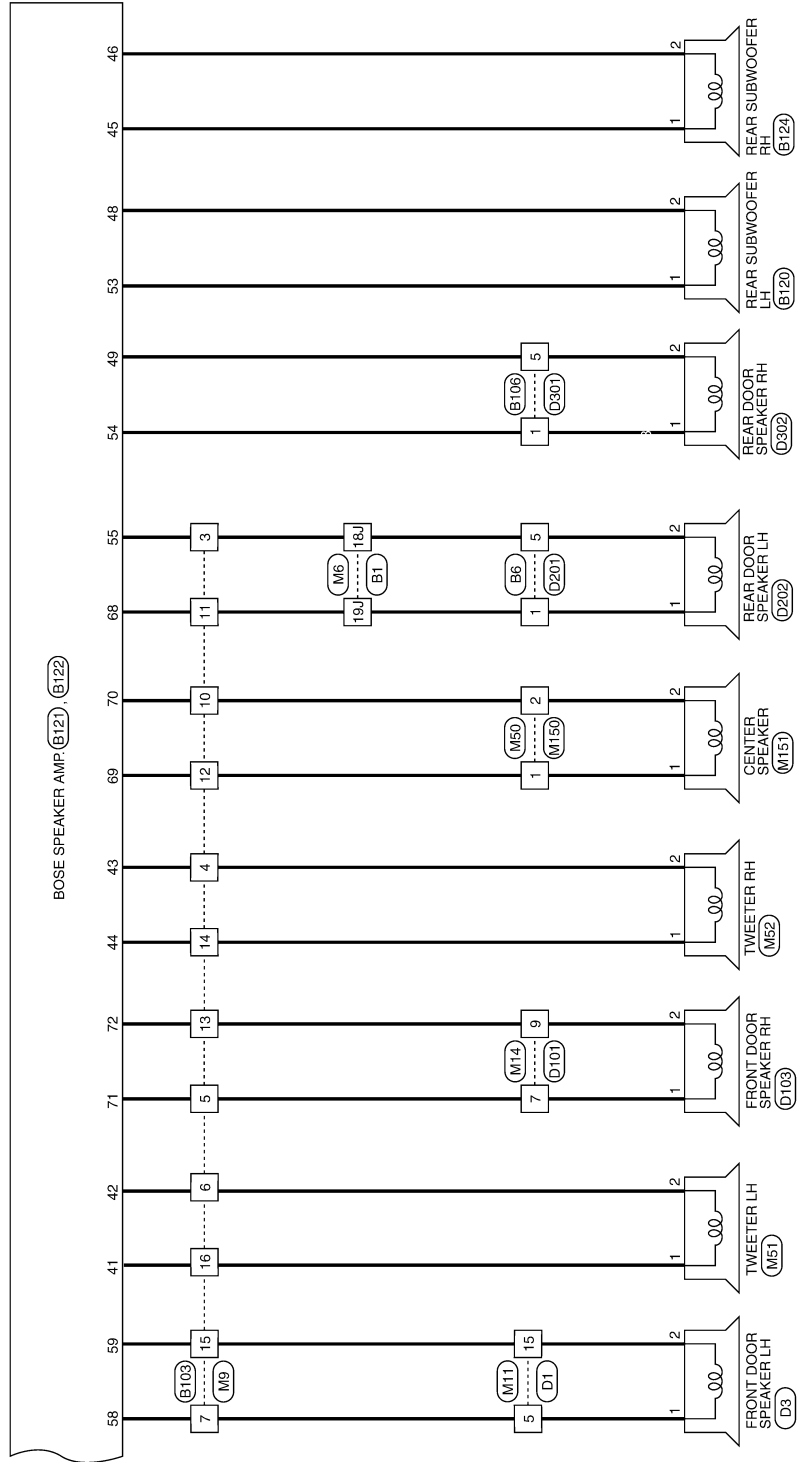

ALNWA0024GE

### BOSE AUDIO WITHOUT NAVIGATION SYSTEM CONNECTORS

Connector No.	M1
Connector Name	WIRE TO WIRE
Connector Color	WHITE

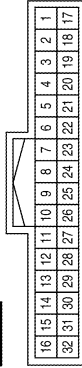
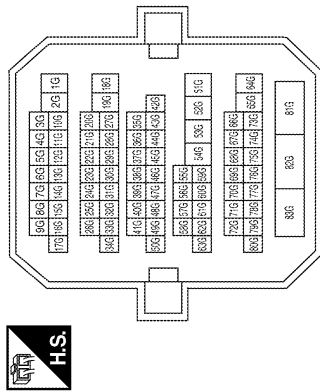

Connector No.	M2
Connector Name	WIRE TO WIRE
Connector Color	WHITE

Terminal No.	Color of Wire	Signal Name
1	V/Y	-
2	Y/G	-
3	SHIELD	-
4	W/L	-
5	R	-
6	L	-
7	B/W	-
8	V/Y	-
9	GR/L	-
10	L/B	-

Terminal No.	Color of Wire	Signal Name
11	Y	-
12	B/R	-
13	R/B	-
14	SHIELD	-
15	R/L	-
16	Y/B	-
18	BR/L	-
19	Y/L	-
20	B	-
21	SHIELD	-
22	G	-
23	SHIELD	-
24	G	-
25	Y/R	-
26	W/G	-
27	BR	-
28	SHIELD	-
30	V/W	-
31	R/W	-

Terminal No.	Color of Wire	Signal Name
53G	B/R	-
54G	BR	-
64G	Y/R	-

Connector No.	M3
Connector Name	FUSE BLOCK (J/B)
Connector Color	WHITE

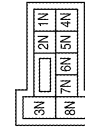

Terminal No.	Color of Wire	Signal Name
2N	G	-
5N	V/Y	-

AWNIA0601GB

A  
B  
C  
D  
E  
F  
G  
H  
I  
J  
K  
L  
M  
N  
O  
P

AV

# AUDIO UNIT (SEDAN)

[BOSE AUDIO WITHOUT NAVIGATION]

< ECU DIAGNOSIS >

Connector No.	M7
Connector Name	WIRE TO WIRE
Connector Color	WHITE

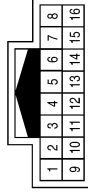

Terminal No.	Color of Wire	Signal Name
1	B/R	-
2	R/B	-
3	R/L	-
4	SHIELD	-
7	Y/R	-
13	BR/W	-

Terminal No.	Color of Wire	Signal Name
18J	BR/B	-
19J	R/G	-

Connector No.	M6
Connector Name	WIRE TO WIRE
Connector Color	WHITE

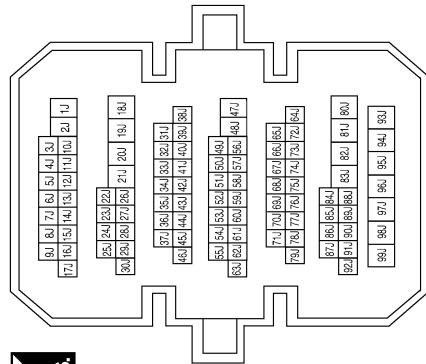

Terminal No.	Color of Wire	Signal Name
12	G	-
13	LG	-
14	SHIELD	-
15	W/L	-
18	GR/L	-
19	L/B	-
21	W	-
22	SHIELD	-
23	R	-

Connector No.	M8
Connector Name	WIRE TO WIRE
Connector Color	WHITE

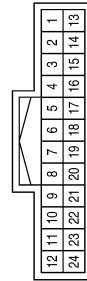

Terminal No.	Color of Wire	Signal Name
2	V	-
3	SHIELD	-
4	GR/V	-
6	W/G	-
8	B/P	-
10	B	-
11	SHIELD	-

ALNIA0031GB



# AUDIO UNIT (SEDAN)

[BOSE AUDIO WITHOUT NAVIGATION]

< ECU DIAGNOSIS >

Connector No.	M9
Connector Name	WIRE TO WIRE
Connector Color	BROWN

7	6	5	4	3	2	1
16	15	14	13	12	11	10
9	8					



Terminal No.	Color of Wire	Signal Name
1	BR	-
3	BR/B	-
4	GR/L	-
5	G/W	-
6	B/Y	-
7	W	-
9	B/R	-
10	O/B	-
11	R/G	-
12	B/P	-
13	BR	-
14	L/O	-
15	B	-
16	LG	-

Connector No.	M11
Connector Name	WIRE TO WIRE
Connector Color	WHITE

1	2	3	4	5	6	7
8	9	10	11	12	13	14
15	16					



Terminal No.	Color of Wire	Signal Name
5	W	-
15	B	-

Connector No.	M14
Connector Name	WIRE TO WIRE
Connector Color	WHITE

1	2	3	4
5	6	7	8
9	10		



Terminal No.	Color of Wire	Signal Name
7	G/W	-
9	BR	-

Connector No.	M24
Connector Name	COMBINATION METER
Connector Color	WHITE



1	2	3	4	5	6	7	8	9	10	11	12	13	14	15	16	17	18	19	20
21	22	23	24	25	26	27	28	29	30	31	32	33	34	35	36	37	38	39	40

Terminal No.	Color of Wire	Signal Name
31	V/W	8P/R OUT

Connector No.	M30
Connector Name	COMBINATION SWITCH (SPIRAL CABLE)
Connector Color	GRAY

24	25	26	27
31	32	33	34



Terminal No.	Color of Wire	Signal Name
24	W/G	AUDIO_STRG_SW_REMOTE_A
31	GR/L	AUDIO_STRG_SW_REMOTE_B
33	L/B	AUDIO_STRG_SW_GND

ALNIA0032GB

A  
B  
C  
D  
E  
F  
G  
H  
I  
J  
K  
L  
M  
N  
O  
P

AV

# AUDIO UNIT (SEDAN)

[BOSE AUDIO WITHOUT NAVIGATION]

< ECU DIAGNOSIS >

Connector No.	M44
Connector Name	AUDIO UNIT
Connector Color	WHITE

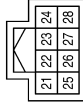

Terminal No.	Color of Wire	Signal Name
21	L	M-CAN +
22	P	M-CAN -
23	SHIELD	-
24	-	-
25	SHIELD	-
26	B/R	TEL I/F +
27	Y	TEL I/F -
28	R/W	TEL ON

Terminal No.	Color of Wire	Signal Name
6	W/G	STRG_SW_A
7	V/Y	ACC
8	-	-
9	-	-
10	SHIELD	-
11	B	FR SP RH (+)
12	W	FR SP RH (-)
13	V	RR SP RH (+)
14	LG	RR SP RH (-)
15	L/B	STRG_SW_GND
16	GR/L	STRG_SW_B
17	-	-
18	V/W	SPEED SIGNAL
19	Y/R	BAT
20	SHIELD	-

Connector No.	M43
Connector Name	AUDIO UNIT
Connector Color	WHITE

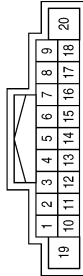

Terminal No.	Color of Wire	Signal Name
1	B/P	AMP_ON
2	G	FR SP LH (+)
3	R	FR SP LH (-)
4	GR/V	RR SP LH (+)
5	W/L	RR SP LH (-)

Connector No.	M50
Connector Name	WIRE TO WIRE
Connector Color	WHITE



Terminal No.	Color of Wire	Signal Name
1	B/P	-
2	O/B	-

Terminal No.	Color of Wire	Signal Name
31	W/L	SAT LH INPUT (-)
32	Y/L	SAT LH INPUT (+)
33	Y/G	SAT RH INPUT (-)
34	BR/L	SAT RH INPUT (+)
35	SHIELD	EARTH
36	SHIELD	DAT EARTH
37	-	-
38	R	RFQ1 (SAT TO COMBI)
39	G	RX (SAT TO COMBI)
40	B	TX (COMBI TO SAT)
41	-	-
42	-	-

Connector No.	M45
Connector Name	AUDIO UNIT
Connector Color	WHITE



AWNIA0602GB

# AUDIO UNIT (SEDAN)

[BOSE AUDIO WITHOUT NAVIGATION]

< ECU DIAGNOSIS >

Connector No.	M81
Connector Name	AUDIO UNIT
Connector Color	GRAY



Terminal No.	Color of Wire	Signal Name
75	B	AMP SUPPLY
76	B	MAIN ANTENNA
77	-	-

Connector No.	M52
Connector Name	TWEETER RH
Connector Color	BROWN



Terminal No.	Color of Wire	Signal Name
1	L/O	-
2	GR/L	-

Connector No.	M51
Connector Name	TWEETER LH
Connector Color	BROWN



Terminal No.	Color of Wire	Signal Name
1	LG	-
2	B/Y	-

Connector No.	M150
Connector Name	WIRE TO WIRE
Connector Color	WHITE



Terminal No.	Color of Wire	Signal Name
1	B/P	-
2	O/B	-

Connector No.	M88
Connector Name	COMBINATION SWITCH (SPIRAL CABLE)
Connector Color	GRAY

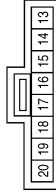

Terminal No.	Color of Wire	Signal Name
14	W	REMOTE A
15	L	REMOTE B
17	BR	GND

Connector No.	M87
Connector Name	WIRE TO WIRE
Connector Color	GRAY

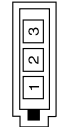

Terminal No.	Color of Wire	Signal Name
1	B	-
2	B	-

Connector No.	M502
Connector Name	ANTENNA AMP
Connector Color	GRAY



Terminal No.	Color of Wire	Signal Name
1	B	-
2	B	-

Connector No.	M501
Connector Name	WIRE TO WIRE
Connector Color	GRAY



Terminal No.	Color of Wire	Signal Name
1	B	-
2	B	-

Connector No.	M151
Connector Name	CENTER SPEAKER
Connector Color	BROWN



Terminal No.	Color of Wire	Signal Name
1	B/P	-
2	O/B	-

ALNIA0034GB

A  
B  
C  
D  
E  
F  
G  
H  
I  
J  
K  
L  
M  
N  
O  
P

AV

# AUDIO UNIT (SEDAN)

[BOSE AUDIO WITHOUT NAVIGATION]

< ECU DIAGNOSIS >

Terminal No.	Color of Wire	Signal Name
18J	BR/B	-
19J	R/G	-

Connector No.	B1
Connector Name	WIRE TO WIRE
Connector Color	WHITE

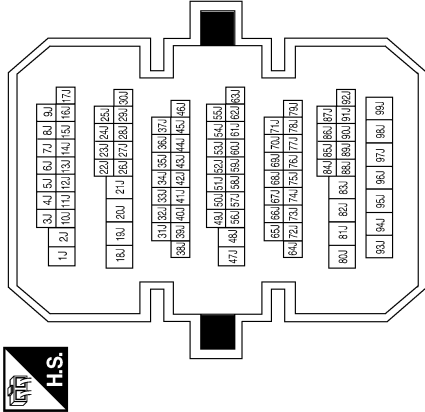

Connector No.	E30
Connector Name	WIRE TO WIRE
Connector Color	WHITE

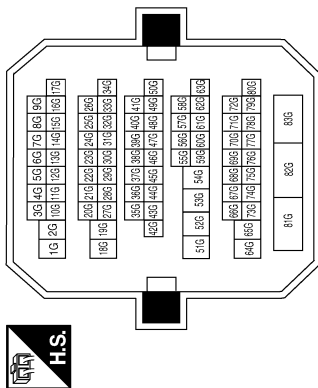

Terminal No.	Color of Wire	Signal Name
53G	B/R	-
54G	BR	-
64G	Y/R	-

Connector No.	B6
Connector Name	WIRE TO WIRE
Connector Color	WHITE



Terminal No.	Color of Wire	Signal Name
1	O/B	-
5	W/R	-

AWNIA0603GB

# AUDIO UNIT (SEDAN)

< ECU DIAGNOSIS >

[BOSE AUDIO WITHOUT NAVIGATION]

Terminal No.	Color of Wire	Signal Name
20	B	-
21	SHIELD	-
22	R/W	-
23	SHIELD	-
24	G/W	-
25	Y/R	-
26	W/G	-
27	BR	-
28	SHIELD	-
30	V/W	-
31	G/O	-

Terminal No.	Color of Wire	Signal Name
7	P	-
8	V/Y	-
9	GR/L	-
10	L/B	-
11	Y	-
12	B/R	-
13	R/B	-
14	SHIELD	-
15	R/L	-
16	Y/B	-
18	BR/L	-
19	Y/L	-

Connector No.	B101
Connector Name	WIRE TO WIRE
Connector Color	WHITE

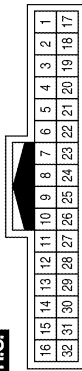

Terminal No.	Color of Wire	Signal Name
1	GR/W	-
2	Y/G	-
3	SHIELD	-
4	W/L	-
5	R/L	-
6	L	-

Terminal No.	Color of Wire	Signal Name
13	V	-
14	SHIELD	-
15	Y	-
18	W/G	-
19	L/B	-
21	GR/V	-
22	SHIELD	-
23	B/R	-

Terminal No.	Color of Wire	Signal Name
2	LG	-
3	SHIELD	-
4	BR	-
6	GR/L	-
8	B/G	-
10	W/L	-
11	SHIELD	-
12	W/R	-

Connector No.	B102
Connector Name	WIRE TO WIRE
Connector Color	WHITE

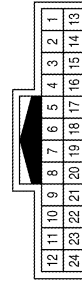

AWNIA0604GB

A  
B  
C  
D  
E  
F  
G  
H  
I  
J  
K  
L  
M  
N  
O  
P

AV



# AUDIO UNIT (SEDAN)

[BOSE AUDIO WITHOUT NAVIGATION]

< ECU DIAGNOSIS >

Connector No.	B122
Connector Name	BOSE SPEAKER AMP
Connector Color	BROWN

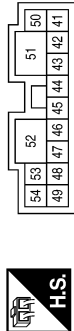

Connector No.	B123
Connector Name	SATELLITE RADIO TUNER OR PRE-WIRING FOR SATELLITE RADIO TUNER
Connector Color	WHITE

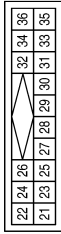

Terminal No.	Color of Wire	Signal Name
21	W/L	SAT_LCH (-)
22	Y/L	SAT_LCH (+)
23	Y/G	SAT_RCH (-)
24	BR/L	SAT_RCH (+)
25	SHIELD	EARTH (SIG)
26	SHIELD	DATA
27	-	-
28	R/L	REQ1 (SAT - COMBI)
29	R/W	TXD (SAT_COMBI)
30	B	RXD (COMBI_SAT)
31	-	-
32	Y/R	BAT
33	-	-
34	-	-
35	-	-
36	GR/W	ACC

Terminal No.	Color of Wire	Signal Name
41	LG	FR TWDR LH + OUT
42	B/Y	FR TWDR LH - OUT
43	GR/L	FR TWDR RH - OUT
44	L/O	FR TWDR RH + OUT
45	BR/W	RH WOOFER + OUT
46	BR	RH WOOFER - OUT
47	B/W	GND
48	G/B	LH WOOFER - OUT
49	B/W	RR DOOR RH - OUT
50	BR	BAT
51	B/R	BAT
52	B/W	GND
53	W/B	LH WOOFER + OUT
54	L	RR DOOR RH + OUT

Connector No.	B124
Connector Name	REAR SUBWOOFER RH
Connector Color	WHITE



Terminal No.	Color of Wire	Signal Name
1	BR/W	-
2	BR	-

Connector No.	B125
Connector Name	BLUETOOTH CONTROL UNIT
Connector Color	WHITE

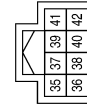

Terminal No.	Color of Wire	Signal Name
35	L	M-CAN+_1
36	P	M-CAN-_2
37	SHIELD	M-CAN_SHIELD_1
39	Y/R	M-CAN_JUMPER 1
40	Y/R	M-CAN+_2
41	SB	M-CAN_JUMPER 1
42	SB	M-CAN-_2

A  
B  
C  
D  
E  
F  
G  
H  
I  
J  
K  
L  
M  
N  
O  
P

AV

ALNIA0081GB

# AUDIO UNIT (SEDAN)

[BOSE AUDIO WITHOUT NAVIGATION]

< ECU DIAGNOSIS >

Connector No.	B126
Connector Name	BLUETOOTH CONTROL UNIT
Connector Color	WHITE

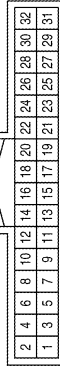

Terminal No.	Color of Wire	Signal Name
1	Y/B	BAT
2	V/Y	ACC
3	G/W	IGN
4	B/W	GND
6	SHIELD	—

Terminal No.	Color of Wire	Signal Name
7	B/R	MIC_IN_+
8	R/B	MIC_IN_-
9	BR	AUDIO_OUT(+)
10	Y	AUDIO_OUT(-)
11	G/O	MUTE_CONTROL
12	W/G	LAD_IN1
13	GR/L	LAD_IN2
14	L/B	LAD_GND
17	W/G	LAD_OUT_1
18	GR/L	LAD_OUT_2
19	L/B	LAD_GND
24	B/W	CONT5
28	V/W	SPEED SIGNAL
29	R/L	MIC_POWER

Connector No.	B129
Connector Name	SATELLITE RADIO TUNER OR PRE-WIRING FOR SATELLITE RADIO TUNER
Connector Color	VIOLET



Terminal No.	Color of Wire	Signal Name
37	B	ANTENNA SIGNAL

Connector No.	B130
Connector Name	SATELLITE RADIO ANTENNA
Connector Color	BROWN



Terminal No.	Color of Wire	Signal Name
1	B	—

Connector No.	D1
Connector Name	WIRE TO WIRE
Connector Color	WHITE

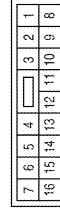

Terminal No.	Color of Wire	Signal Name
5	W	—
15	B	—

Connector No.	D3
Connector Name	FRONT DOOR SPEAKER LH
Connector Color	WHITE



Terminal No.	Color of Wire	Signal Name
1	W	—
2	B	—

AWNIA0606GB



# AUDIO UNIT (SEDAN)

[BOSE AUDIO WITHOUT NAVIGATION]

< ECU DIAGNOSIS >

Connector No.	D201
Connector Name	WIRE TO WIRE
Connector Color	WHITE

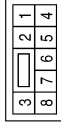

Terminal No.	Color of Wire	Signal Name
1	O/B	-
5	W/R	-

Connector No.	D103
Connector Name	FRONT DOOR SPEAKER RH
Connector Color	BROWN



Terminal No.	Color of Wire	Signal Name
1	G/W	-
2	BR	-

Connector No.	D101
Connector Name	WIRE TO WIRE
Connector Color	WHITE

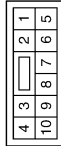

Terminal No.	Color of Wire	Signal Name
7	G/W	-
9	BR	-

Connector No.	D302
Connector Name	REAR DOOR SPEAKER RH
Connector Color	BROWN



Terminal No.	Color of Wire	Signal Name
1	L	-
2	B/W	-

Connector No.	D301
Connector Name	WIRE TO WIRE
Connector Color	WHITE

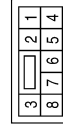

Terminal No.	Color of Wire	Signal Name
1	L	-
5	B/W	-

Connector No.	D202
Connector Name	REAR DOOR SPEAKER LH
Connector Color	BROWN



Terminal No.	Color of Wire	Signal Name
1	O/B	-
2	W/R	-

AWNIA0607GB

A  
B  
C  
D  
E  
F  
G  
H  
I  
J  
K  
L  
M  
N  
O  
P

AV

# AUDIO UNIT (SEDAN)

[BOSE AUDIO WITHOUT NAVIGATION]

< ECU DIAGNOSIS >

Connector No.	D302
Connector Name	REAR DOOR SPEAKER RH
Connector Color	BROWN



Terminal No.	Color of Wire	Signal Name
1	L	-
2	B/W	-

Connector No.	R1
Connector Name	WIRE TO WIRE
Connector Color	WHITE

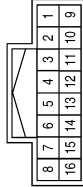

Terminal No.	Color of Wire	Signal Name
1	W	-
2	R	-
3	B	-
4	SHIELD	-
7	B/Y	-
13	BR	-

Connector No.	R7
Connector Name	MICROPHONE
Connector Color	WHITE

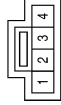

Terminal No.	Color of Wire	Signal Name
1	W	SIG
2	R	GND
4	B	VCC

Connector No.	R8
Connector Name	BLUETOOTH ON INDICATOR
Connector Color	WHITE

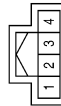

Terminal No.	Color of Wire	Signal Name
1	BR	IND
2	B/Y	BAT

ALNIA0084GB

# BOSE SPEAKER AMP

[BOSE AUDIO WITHOUT NAVIGATION]

< ECU DIAGNOSIS >

## BOSE SPEAKER AMP

Reference Value

INFOID:000000001830638

### TERMINAL LAYOUT

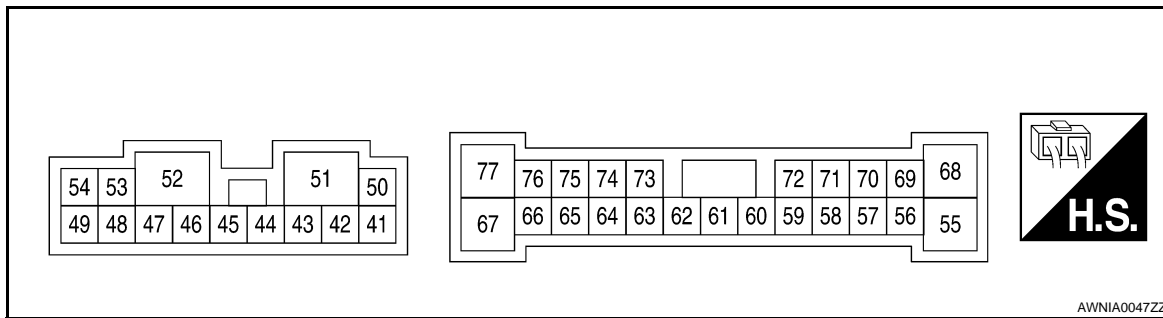

### PHYSICAL VALUES

Terminal (wire color)		Item	Signal input/output	Condition		Reference value
+	-			Ignition switch	Operation	
41 (LG)	42 (B/Y)	Front tweeter LH	Output	ON	Receive audio signal	 SKIA0177E
44 (L/O)	43 (GR/L)	Front tweeter RH	Output	ON	Receive audio signal	 SKIA0177E
45 (BR/W)	46 (BR)	Subwoofer RH	Output	ON	Receive audio signal	 SKIA0177E
47 (B/W)	Ground	Ground	-	ON	-	-
50 (BR)	Ground	Battery	Input	-	-	Battery voltage
51 (B/R)						
52 (B/W)	Ground	Ground	-	ON	-	-

A  
B  
C  
D  
E  
F  
G  
H  
I  
J  
K  
L  
M  
O  
P

AV

# BOSE SPEAKER AMP

[BOSE AUDIO WITHOUT NAVIGATION]

< ECU DIAGNOSIS >

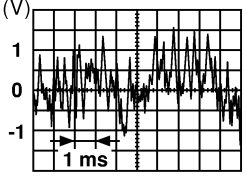
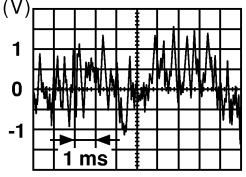
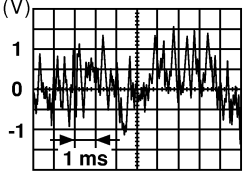
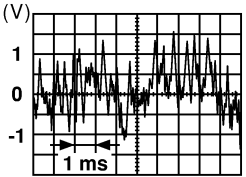
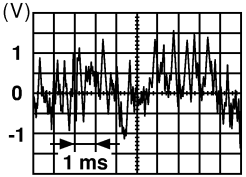
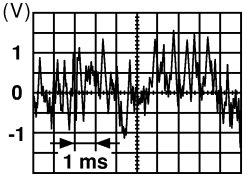
Terminal (wire color)		Item	Signal in- put/out- put	Condition		Reference value
+	-			Ignition switch	Operation	
53 (W/B)	48 (G/B)	Subwoofer LH	Output	ON	Receive audio sig- nal	 <p style="text-align: right; font-size: small;">SKIA0177E</p>
54 (L)	49 (B/W)	Rear tweeter RH	Output	ON	Receive audio sig- nal	 <p style="text-align: right; font-size: small;">SKIA0177E</p>
58 (W)	59 (B)	Door speaker LH	Output	ON	Receive audio sig- nal	 <p style="text-align: right; font-size: small;">SKIA0177E</p>
60 (B/G)	Ground	Amp. ON signal	Input	ON	-	More than approx. 6.5V
64 (BR)	63 (Y)	Audio sound sig- nal rear LH	Input	ON	Receive audio sig- nal	 <p style="text-align: right; font-size: small;">SKIA0177E</p>
66 (LG)	65 (V)	Audio sound sig- nal rear RH	Input	ON	Receive audio sig- nal	 <p style="text-align: right; font-size: small;">SKIA0177E</p>
68 (R/G)	55 (BR/B)	Rear tweeter LH	Output	ON	Receive audio sig- nal	 <p style="text-align: right; font-size: small;">SKIA0177E</p>

# BOSE SPEAKER AMP

[BOSE AUDIO WITHOUT NAVIGATION]

< ECU DIAGNOSIS >

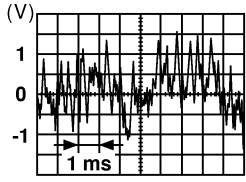
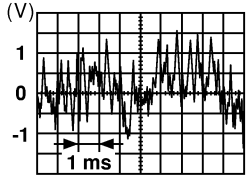
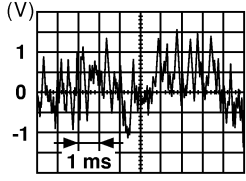
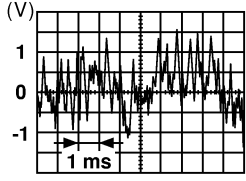
Terminal (wire color)		Item	Signal in- put/out- put	Condition		Reference value
+	-			Ignition switch	Operation	
69 (B/P)	70 (O/B)	Center speaker	Output	ON	Receive audio sig- nal	 <p style="text-align: right; font-size: small;">SKIA0177E</p>
71 (G/W)	72 (B/R)	Door speaker RH	Output	ON	Receive audio sig- nal	 <p style="text-align: right; font-size: small;">SKIA0177E</p>
73 (W/L)	74 (GR/V)	Audio sound sig- nal front RH	Input	ON	Receive audio sig- nal	 <p style="text-align: right; font-size: small;">SKIA0177E</p>
75 (W/R)	76 (B/R)	Audio sound sig- nal front LH	Input	ON	Receive audio sig- nal	 <p style="text-align: right; font-size: small;">SKIA0177E</p>

A  
B  
C  
D  
E  
F  
G  
H  
I  
J  
K  
L  
M

AV

O  
P

# SATELLITE RADIO TUNER

< ECU DIAGNOSIS >

[BOSE AUDIO WITHOUT NAVIGATION]

## SATELLITE RADIO TUNER

Reference Value

INFOID:000000001830639

### TERMINAL LAYOUT

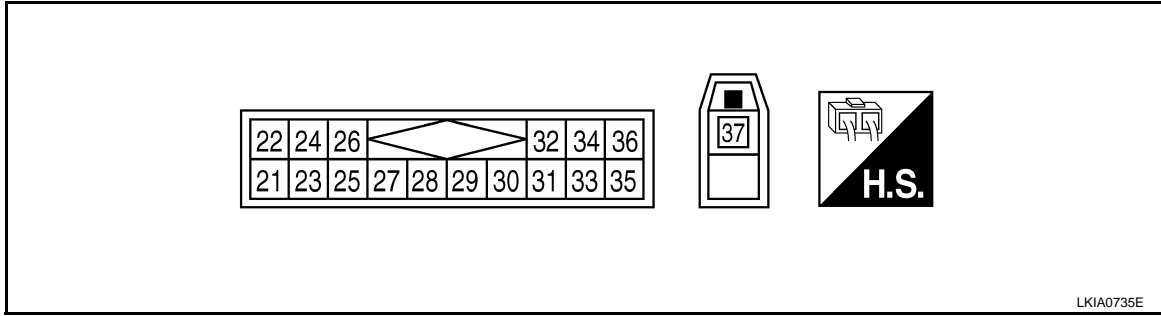

### PHYSICAL VALUES

Terminal (Wire color)		Item	Signal input/ output	Condition		Voltage (approx.)
+	-			Ignition switch	Operation	
22 (Y/L)	21 (W/L)	Audio signal LH	Output	ON	Receive audio signal.	<p>SKIB3609E</p>
24 (BR/L)	23 (Y/G)	Audio signal RH	Output	ON	Receive audio signal.	<p>SKIB3609E</p>
25	-	Shield	-	-	-	-
26	-	Data ground	-	ON	-	Approx. 0 V
28 (R/L)	Ground	REQ1 (SAT-AUDIO)	Output	ON	Set to the satellite radio mode	<p>SKIB3825E</p>
29 (R/W)	Ground	Communication signal (SAT-AUDIO)	Output	ON	Set to the satellite radio mode	<p>SKIB3824E</p>

# SATELLITE RADIO TUNER

[BOSE AUDIO WITHOUT NAVIGATION]

< ECU DIAGNOSIS >

Terminal (Wire color)		Item	Signal input/ output	Condition		Voltage (approx.)
+	-			Ignition switch	Operation	
30 (B)	Ground	Communication signal (AUDIO-SAT)	Input	ON	Set to the satellite radio mode	
32 (Y/R)	Ground	Battery power supply	Input	OFF	-	Battery voltage
36 (GR/W)		ACC power supply		ACC		
37		-		-		

A  
B  
C  
D  
E  
F  
G  
H  
I  
J  
K  
L  
M

AV

O  
P

# BLUETOOTH CONTROL UNIT

< ECU DIAGNOSIS >

[BOSE AUDIO WITHOUT NAVIGATION]

## BLUETOOTH CONTROL UNIT

Reference Value

INFOID:000000001830640

### TERMINAL LAYOUT

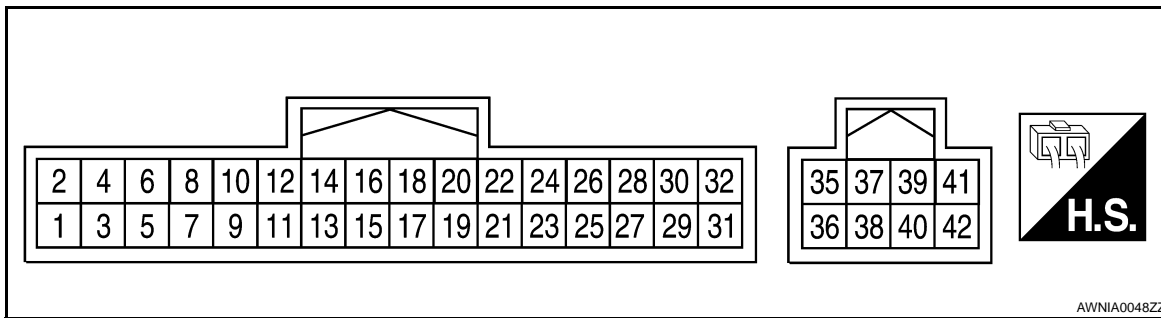

### PHYSICAL VALUES



Terminal (Wire color)		Item	Signal input/ output	Condition		Reference value (Approx.)
+	-			Ignition switch	Operation	
1 (Y/B)	Ground	Battery power	Input	-	-	Battery voltage
2 (V/Y)	Ground	ACC power	Input	ACC/ON	-	Battery voltage
3 (G/W)	Ground	IGN power	Input	ON/ START	-	Battery voltage
4 (B/W)	-	Ground	-	-	-	-
6	-	Shield	-	-	-	-
7 (B/R)	8 (R/B)	Mic-in signal	Input	-	-	-
9 (BR)	10 (Y)	Audio out	Output	ACC/ON	Bluetooth control unit sends audio sig- nal	 SKIB3609E
11 (G/O)	-	Mute	Output	-	-	-
12 (W/G)	Ground	Remote con- trol switch 1	Input	ACC/ON	Press SEEK DOWN switch.	0.7 V
					Press SEEK UP switch.	1.3 V
					Pressing  switch.	2.0 V
					Except for above.	3.3 V



# BLUETOOTH CONTROL UNIT

[BOSE AUDIO WITHOUT NAVIGATION]

< ECU DIAGNOSIS >

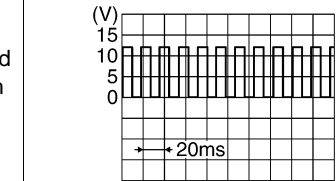
Terminal (Wire color)		Item	Signal input/ output	Condition		Reference value (Approx.)
+	-			Ignition switch	Operation	
13 (GR/L)	Ground	Remote con- trol switch 2	Input	ACC/ON	Press SOURCE switch.	0 V
					Press  switch.	0.7 V
					Press VOL UP switch.	1.3 V
					Press VOL DOWN switch	2 V
					Except for above.	3.3 V
14 (L/B)	-	Remote con- trol ground	Input	-	-	-
17 (W/G)	Ground	Steeringswitch 1	Output	ACC/ON	Press SEEK DOWN switch.	0.7 V
					Press SEEK UP switch.	1.3 V
					Pressing  switch.	2.0 V
					Except for above.	3.3 V
18 (GR/L)	Ground	Steeringswitch 2	Output	ACC/ON	Press SOURCE switch.	0 V
					Press  switch.	0.7 V
					Press VOL UP switch.	1.3 V
					Press VOL DOWN switch	2 V
					Except for above.	3.3 V
19 (L/B)	Ground	Steeringswitch ground	Output	-	-	-
24 (B/W)	-	Ground	-	-	-	-
28 (V/W)	-	Vehicle speed signal (8- pulse)	Input	ON	When vehicle speed is approx. 40 km/h (25 MPH)	 <p style="text-align: right; font-size: small;">PKIA1935E</p>
29 (R/L)	Ground	Microphone power	Output	-	-	-
35 (L)	-	M-CAN (+)	-	-	-	-
36 (P)	-	M-CAN (-)	-	-	-	-
37	-	Shield ground	-	-	-	-
39 (Y/R)	-	M-CAN jump- er-1	-	-	-	-
40 (Y/R)	-	M-CAN (+) 2	-	-	-	-

A  
B  
C  
D  
E  
F  
G  
H  
I  
J  
K  
L  
M  
AV  
O  
P

# BLUETOOTH CONTROL UNIT

[BOSE AUDIO WITHOUT NAVIGATION]

< ECU DIAGNOSIS >

Terminal (Wire color)		Item	Signal input/ output	Condition		Reference value (Approx.)
+	-			Ignition switch	Operation	
41 (SB)	-	M-CAN jump- er-1	-	-	-	
42 (SB)	-	M-CAN (-) 2	-	-	-	

# AUDIO SYSTEM (COUPE)

[BOSE AUDIO WITHOUT NAVIGATION]

< SYMPTOM DIAGNOSIS >

## SYMPTOM DIAGNOSIS

### AUDIO SYSTEM (COUPE)

#### Symptom Table

INFOID:000000001830641

#### AUDIO SYSTEM

Symptom	Possible cause	Reference page
Inoperative	<ul style="list-style-type: none"> <li>Audio unit power circuit</li> <li>Audio unit</li> </ul>	<ul style="list-style-type: none"> <li><a href="#">AV-100</a></li> <li><a href="#">AV-204</a></li> </ul>
Steering switch does not operate	<ul style="list-style-type: none"> <li>Steering wheel audio control switch</li> <li>Audio unit</li> </ul>	<ul style="list-style-type: none"> <li><a href="#">AV-134</a></li> <li><a href="#">AV-204</a></li> </ul>
All speakers do not sound	<ul style="list-style-type: none"> <li>Audio unit</li> <li>Audio unit power circuit</li> <li>BOSE speaker amp. ON signal</li> <li>BOSE speaker amp. ground circuit</li> <li>BOSE speaker amp.</li> </ul>	<ul style="list-style-type: none"> <li><a href="#">AV-204</a></li> <li><a href="#">AV-100</a></li> <li><a href="#">AV-133</a></li> <li><a href="#">AV-100</a></li> <li><a href="#">AV-205</a></li> </ul>
One or several speakers do not sound	<ul style="list-style-type: none"> <li>Door speaker</li> <li>Front tweeter</li> <li>Center speaker</li> <li>Rear tweeter</li> <li>Subwoofer</li> </ul>	<ul style="list-style-type: none"> <li><a href="#">AV-209</a></li> <li><a href="#">AV-207</a></li> <li><a href="#">AV-208</a></li> <li><a href="#">AV-211</a></li> <li><a href="#">AV-213</a></li> </ul>

#### CD

Symptom	Possible cause	Reference page
CD cannot be inserted.	Audio unit	<a href="#">AV-204</a>
CD cannot be ejected.		
The CD cannot be played.		
The sound skips, stops suddenly, or is distorted.		

#### SATELLITE RADIO

Symptom	Possible cause	Reference page
Inoperative	<ul style="list-style-type: none"> <li>Satellite radio tuner power or ground circuit</li> <li>Satellite radio tuner communication circuit</li> <li>Satellite radio tuner</li> </ul>	<ul style="list-style-type: none"> <li><a href="#">AV-106</a></li> <li><a href="#">AV-140</a></li> <li><a href="#">AV-214</a></li> </ul>
Right or left channel does not sound	<ul style="list-style-type: none"> <li>Satellite radio tuner right channel audio signal circuit</li> <li>Satellite radio tuner left channel audio signal circuit</li> <li>Satellite radio tuner</li> </ul>	<ul style="list-style-type: none"> <li><a href="#">AV-144</a></li> <li><a href="#">AV-144</a></li> <li><a href="#">AV-214</a></li> </ul>

#### HANDS-FREE PHONE

Symptom	Possible cause	Reference page
Inoperative	<ul style="list-style-type: none"> <li>Bluetooth control unit power and ground circuit</li> <li>Bluetooth control unit</li> </ul>	<ul style="list-style-type: none"> <li><a href="#">AV-107</a></li> <li><a href="#">AV-227</a></li> </ul>
Steering switch does not operate	<ul style="list-style-type: none"> <li>Steering wheel audio control switch</li> <li>Bluetooth control unit</li> </ul>	<ul style="list-style-type: none"> <li><a href="#">AV-134</a></li> <li><a href="#">AV-227</a></li> </ul>
Voice activated control does not operate	<ul style="list-style-type: none"> <li>Microphone</li> <li>Steering wheel audio control switch</li> <li>Bluetooth control unit</li> </ul>	<ul style="list-style-type: none"> <li><a href="#">AV-148</a></li> <li><a href="#">AV-134</a></li> <li><a href="#">AV-227</a></li> </ul>

# AUDIO SYSTEM (SEDAN)

[BOSE AUDIO WITHOUT NAVIGATION]

< SYMPTOM DIAGNOSIS >

## AUDIO SYSTEM (SEDAN)

### Symptom Table

INFOID:000000003289160

#### AUDIO SYSTEM

Symptom	Possible cause	Reference page
Inoperative	<ul style="list-style-type: none"><li>• Audio unit power circuit</li><li>• Audio unit</li></ul>	<ul style="list-style-type: none"><li>• <a href="#">AV-105</a></li><li>• <a href="#">AV-204</a></li></ul>
Steering switch does not operate	<ul style="list-style-type: none"><li>• Steering wheel audio control switch</li><li>• Audio unit</li></ul>	<ul style="list-style-type: none"><li>• <a href="#">AV-137</a></li><li>• <a href="#">AV-204</a></li></ul>
All speakers do not sound	<ul style="list-style-type: none"><li>• Audio unit</li><li>• Audio unit power circuit</li><li>• BOSE speaker amp. ON signal</li><li>• BOSE speaker amp. ground circuit</li><li>• BOSE speaker amp.</li></ul>	<ul style="list-style-type: none"><li>• <a href="#">AV-204</a></li><li>• <a href="#">AV-105</a></li><li>• <a href="#">AV-133</a></li><li>• <a href="#">AV-105</a></li><li>• <a href="#">AV-205</a></li></ul>
One or several speakers do not sound	<ul style="list-style-type: none"><li>• Front door speaker</li><li>• Tweeter</li><li>• Center speaker</li><li>• Rear door speaker</li><li>• Subwoofer</li></ul>	<ul style="list-style-type: none"><li>• <a href="#">AV-113</a></li><li>• <a href="#">AV-119</a></li><li>• <a href="#">AV-122</a></li><li>• <a href="#">AV-127</a></li><li>• <a href="#">AV-130</a></li></ul>

#### CD

Symptom	Possible cause	Reference page
CD cannot be inserted.	Audio unit	<a href="#">AV-204</a>
CD cannot be ejected.		
The CD cannot be played.		
The sound skips, stops suddenly, or is distorted.		

#### SATELLITE RADIO

Symptom	Possible cause	Reference page
Inoperative	<ul style="list-style-type: none"><li>• Satellite radio tuner power or ground circuit</li><li>• Satellite radio tuner communication circuit</li><li>• Satellite radio tuner</li></ul>	<ul style="list-style-type: none"><li>• <a href="#">AV-106</a></li><li>• <a href="#">AV-142</a></li><li>• <a href="#">AV-214</a></li></ul>
Right or left channel does not sound	<ul style="list-style-type: none"><li>• Satellite radio tuner right channel audio signal circuit</li><li>• Satellite radio tuner left channel audio signal circuit</li><li>• Satellite radio tuner</li></ul>	<ul style="list-style-type: none"><li>• <a href="#">AV-146</a></li><li>• <a href="#">AV-146</a></li><li>• <a href="#">AV-214</a></li></ul>

#### HANDS-FREE PHONE

Symptom	Possible cause	Reference page
Inoperative	<ul style="list-style-type: none"><li>• Bluetooth control unit power and ground circuit</li><li>• Bluetooth control unit</li></ul>	<ul style="list-style-type: none"><li>• <a href="#">AV-107</a></li><li>• <a href="#">AV-99</a></li></ul>
Steering switch does not operate	<ul style="list-style-type: none"><li>• Steering wheel audio control switch</li><li>• Bluetooth control unit</li></ul>	<ul style="list-style-type: none"><li>• <a href="#">AV-137</a></li><li>• <a href="#">AV-99</a></li></ul>
Voice activated control does not operate	<ul style="list-style-type: none"><li>• Microphone</li><li>• Steering wheel audio control switch</li><li>• Bluetooth control unit</li></ul>	<ul style="list-style-type: none"><li>• <a href="#">AV-148</a></li><li>• <a href="#">AV-137</a></li><li>• <a href="#">AV-99</a></li></ul>

# NORMAL OPERATING CONDITION

< SYMPTOM DIAGNOSIS >

[BOSE AUDIO WITHOUT NAVIGATION]

## NORMAL OPERATING CONDITION

### Description

INFOID:000000001830642

The majority of the audio concerns are the result of outside causes (bad CD, electromagnetic interference, etc.).

### NOISE

The following noise results from variations in field strength, such as fading noise and multi-path noise, or external noise from trains and other sources. It is not a malfunction.

- Fading noise: This noise occurs because of variations in the field strength in a narrow range due to mountains or buildings blocking the signal.
- Multi-path noise: This noise results from the waves sent directly from the broadcast station arriving at the antenna at a different time from the waves which reflect off mountains or buildings.

The vehicle itself can be a source of noise if noise prevention parts or electrical equipment is malfunctioning. Check if noise is caused and/or changed by engine speed, ignition switch turned to each position, and operation of each piece of electrical equipment, and determine the cause.

### NOTE:

The source of the noise can be found easily by listening to the noise while removing the fuses of electrical components, one by one.

### Type of Noise and Possible Cause

Occurrence condition		Possible cause
Occurs only when engine is ON.	A continuous growling noise occurs. The speed of the noise varies with changes in the engine speed.	• Ignition components
The occurrence of the noise is linked with the operation of the fuel pump.		• Fuel pump condenser
Noise only occurs when various electrical components are operating.	A cracking or snapping sound occurs with the operation of various switches.	• Relay malfunction, audio unit malfunction
	The noise occurs when various motors are operating.	• Motor case ground • Motor
The noise occurs constantly, not just under certain conditions.		• Rear defogger coil malfunction • Open circuit in printed heater • Poor ground of antenna feeder line
A cracking or snapping sound occurs while the vehicle is being driven, especially when it is vibrating excessively.		• Ground wire of body parts • Ground due to improper part installation • Wiring connections or a short circuit

A  
B  
C  
D  
E  
F  
G  
H  
I  
J  
K  
L  
M  
O  
P

AV

## PRECAUTION

### PRECAUTIONS

#### Supplemental Restraint System (SRS) "AIR BAG" and "SEAT BELT PRE-TENSIONER"

INFOID:000000001346006

The Supplemental Restraint System such as "AIR BAG" and "SEAT BELT PRE-TENSIONER", used along with a front seat belt, helps to reduce the risk or severity of injury to the driver and front passenger for certain types of collision. This system includes seat belt switch inputs and dual stage front air bag modules. The SRS system uses the seat belt switches to determine the front air bag deployment, and may only deploy one front air bag, depending on the severity of a collision and whether the front occupants are belted or unbelted. Information necessary to service the system safely is included in the SR and SB section of this Service Manual.

**WARNING:**

- To avoid rendering the SRS inoperative, which could increase the risk of personal injury or death in the event of a collision which would result in air bag inflation, all maintenance must be performed by an authorized NISSAN/INFINITI dealer.
- Improper maintenance, including incorrect removal and installation of the SRS, can lead to personal injury caused by unintentional activation of the system. For removal of Spiral Cable and Air Bag Module, see the SR section.
- Do not use electrical test equipment on any circuit related to the SRS unless instructed to in this Service Manual. SRS wiring harnesses can be identified by yellow and/or orange harnesses or harness connectors.

# PREPARATION

< PREPARATION >

[BOSE AUDIO WITHOUT NAVIGATION]

## PREPARATION

### PREPARATION

#### Commercial Service Tools

INFOID:000000001346007

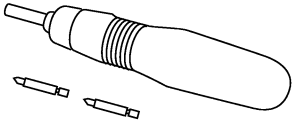
Tool name	Description
<p>Power tool</p>  <p>PBIC0191E</p>	<p>Loosening bolts and nuts</p>

A  
B  
C  
D  
E  
F  
G  
H  
I  
J  
K  
L  
M  
AV  
O  
P

**ON-VEHICLE REPAIR****AUDIO UNIT****Removal and Installation**

INFOID:000000003110982

**REMOVAL**

1. Remove the cluster lid D. Refer to [JP-11, "Removal and Installation"](#).
2. Remove the cluster lid D screws (A), then remove the audio unit screws (B) and the audio unit (1).

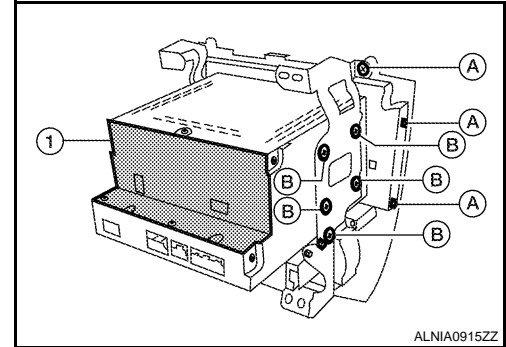
**INSTALLATION**

Installation is in the reverse order of removal.



# BOSE SPEAKER AMP

[BOSE AUDIO WITHOUT NAVIGATION]

< ON-VEHICLE REPAIR >

## BOSE SPEAKER AMP

### Removal and Installation - Coupe

INFOID:000000001346009

#### REMOVAL

1. Disconnect the battery negative terminal.
2. Remove the trunk floor carpet and spare tire cover. Refer to [INT-22, "Removal and Installation"](#).
3. Remove the RH trunk floor spacer.
4. Remove the Bose speaker amp. screws (A), then disconnect the Bose speaker amp. connectors (B) and remove the Bose speaker amp. (1).

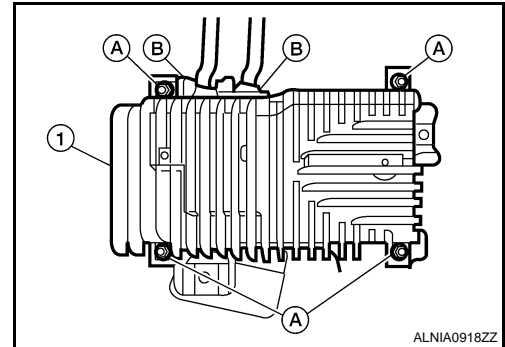

#### INSTALLATION

Installation is in the reverse order of removal.

### Removal and Installation - Sedan

INFOID:000000003110985

#### REMOVAL

1. Disconnect the battery negative terminal.
2. Remove the rear parcel shelf. Refer to [INT-36, "Removal and Installation"](#).
3. Remove the Bose speaker amp. screws (a), then disconnect the Bose speaker amp. connectors and remove the speaker amplifier (1).

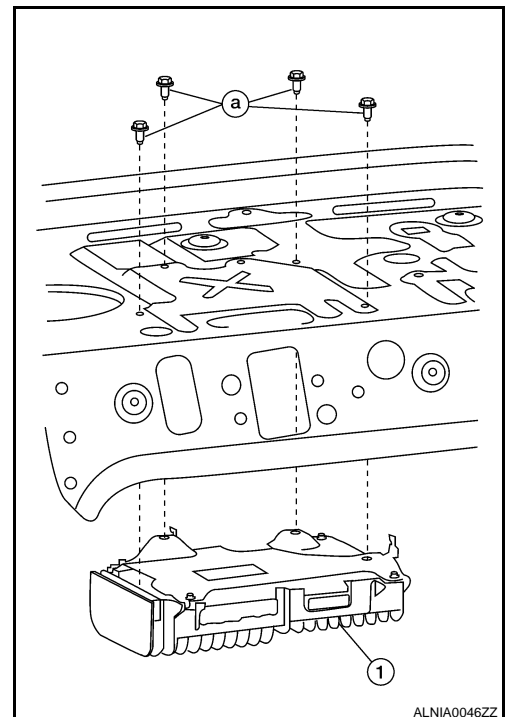

#### INSTALLATION

Installation is in the reverse order of removal.

A  
B  
C  
D  
E  
F  
G  
H  
I  
J  
K  
L  
M  
AV  
O  
P

# CD CHANGER

< ON-VEHICLE REPAIR >

[BOSE AUDIO WITHOUT NAVIGATION]

## CD CHANGER

### Removal and Installation

INFOID:000000001346010

#### REMOVAL

1. Remove the Cluster D lower finisher. Refer to [JP-11, "Removal and Installation"](#).
2. Put selector lever in the drive "D" position (CVT models only).
3. Put shift lever in neutral (M/T models only).
4. Using a suitable tool remove the CD changer finisher (1), then disconnect the power socket, AUX jack connectors and remove the CD changer finisher (1).

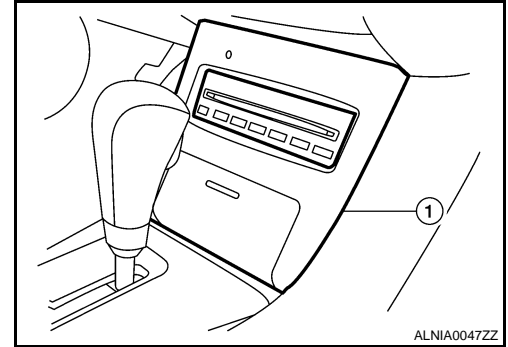

5. Remove the CD changer screws (A), pull out the unit, then disconnect the CD changer connector and remove the CD changer (1).

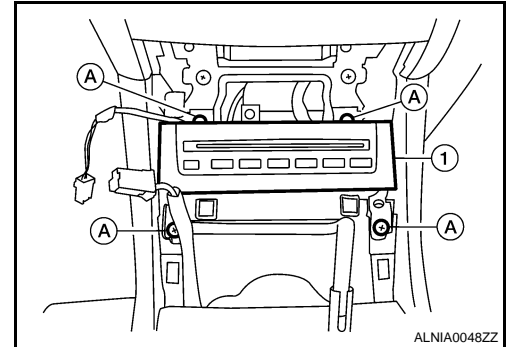

6. Remove the CD changer bracket screws (A).
  - CD changer brackets (1)
  - CD changer (2)

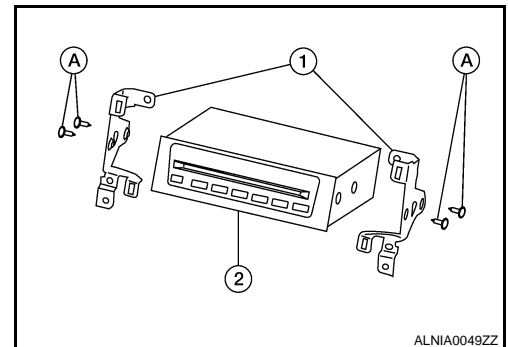

#### INSTALLATION

Installation is in the reverse order of removal.

# FRONT TWEETER

< ON-VEHICLE REPAIR >

[BOSE AUDIO WITHOUT NAVIGATION]

## FRONT TWEETER

### Removal and Installation

INFOID:000000003183459

#### REMOVAL

1. Remove the front pillar finisher. Refer to [INT-19, "Removal and Installation"](#).
2. Remove tweeter speaker grille. Refer to [IP-11, "Removal and Installation"](#).
3. Remove the tweeter speaker screws (A), disconnect the tweeter speaker connector and remove the tweeter speaker (1).

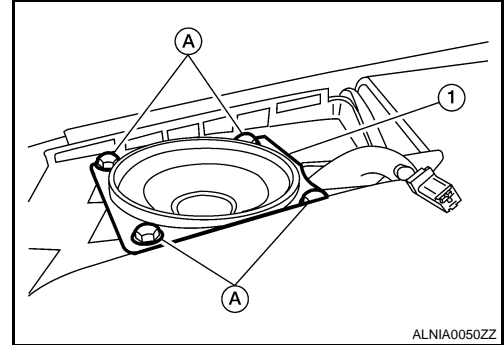

#### INSTALLATION

Installation is in the reverse order of removal.

A  
B  
C  
D  
E  
F  
G  
H  
I  
J  
K  
L  
M  
O  
P

AV

## CENTER SPEAKER

< ON-VEHICLE REPAIR >

[BOSE AUDIO WITHOUT NAVIGATION]

### CENTER SPEAKER

#### Removal and Installation

INFOID:000000001346012

#### REMOVAL

1. Remove the center speaker grille. Refer to [IP-11, "Removal and Installation"](#).
2. Remove the center speaker screws (A), then pull out the center speaker (1), then disconnect the center speaker connector and remove the center speaker (1).

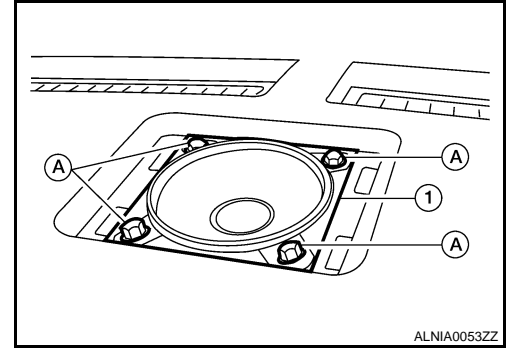

#### INSTALLATION

Installation is in the reverse order of removal.

# FRONT DOOR SPEAKER

< ON-VEHICLE REPAIR >

[BOSE AUDIO WITHOUT NAVIGATION]

## FRONT DOOR SPEAKER

### Removal and Installation

INFOID:000000003184432

#### REMOVAL

1. Remove the front door finisher. Refer to [INT-11, "Removal and Installation"](#).
2. Remove the front door speaker screws (A), then disconnect the front door speaker connector and remove the front door speaker (1).

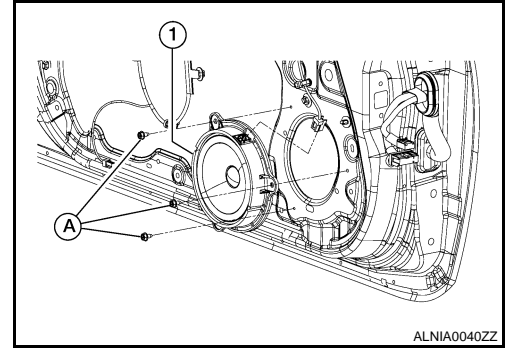

#### INSTALLATION

Installation is in the reverse order of removal.

A  
B  
C  
D  
E  
F  
G  
H  
I  
J  
K  
L  
M  
O  
P

AV

## REAR DOOR SPEAKER

< ON-VEHICLE REPAIR >

[BOSE AUDIO WITHOUT NAVIGATION]

### REAR DOOR SPEAKER

#### Removal and Installation - Sedan

INFOID:000000003185277

#### REMOVAL

1. Remove the rear door finisher. Refer to [INT-32. "Removal and Installation"](#).
2. Remove the rear door speaker screws (A), then disconnect the rear door speaker connector and remove the rear door speaker (1).

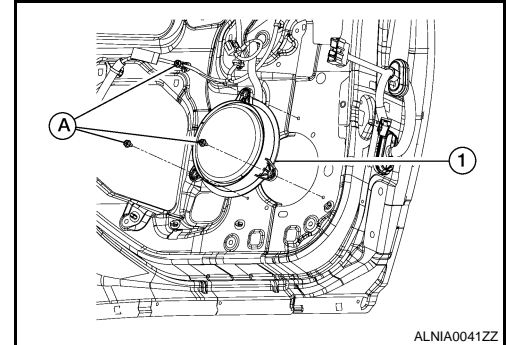

#### INSTALLATION

Installation is in the reverse order of removal.

# REAR TWEETER

< ON-VEHICLE REPAIR >

[BOSE AUDIO WITHOUT NAVIGATION]

## REAR TWEETER

### Removal and Installation - Coupe

INFOID:000000001756743

#### REMOVAL

1. Remove the rear parcel shelf finisher. Refer to [INT-16. "Removal and Installation"](#).
2. Remove the rear tweeter speaker screws (A) and remove the rear tweeter speaker (1).

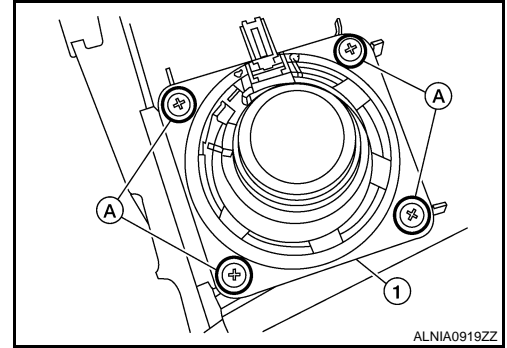

#### INSTALLATION

Installation is in the reverse order of removal.

A  
B  
C  
D  
E  
F  
G  
H  
I  
J  
K  
L  
M  
AV  
O  
P

## REAR SPEAKER

< ON-VEHICLE REPAIR >

[BOSE AUDIO WITHOUT NAVIGATION]

### REAR SPEAKER

#### Removal and Installation - Coupe

INFOID:000000003185278

##### REMOVAL

1. Remove the trunk front finisher. Refer to [INT-22, "Removal and Installation"](#).
2. Remove the rear speaker screws (A), then disconnect the rear speaker connector (B) and remove the rear speaker (1).

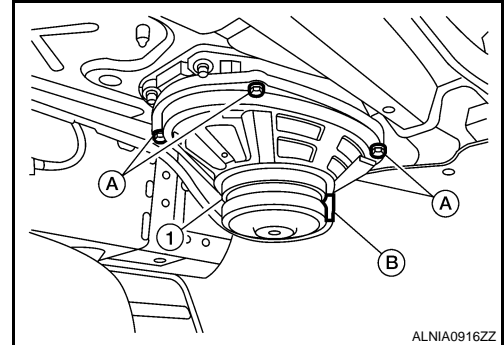

##### INSTALLATION

Installation is in the reverse order of removal.

#### Removal and Installation - Sedan

INFOID:000000003185279

##### REMOVAL

1. Remove the rear parcel shelf finisher. Refer to [INT-44, "Removal and Installation"](#).
2. Remove the rear speaker screws (A), then disconnect the rear speaker and remove the rear speaker (1).

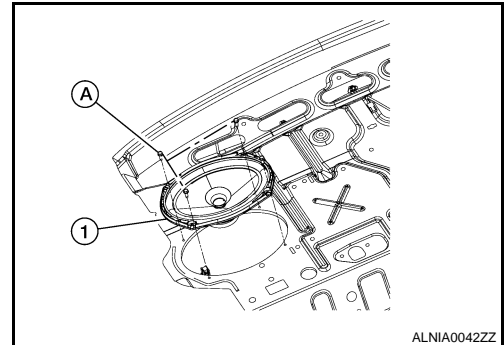

##### INSTALLATION

Installation is in the reverse order of removal.



WOOFER

Components

INFOID:000000001346016

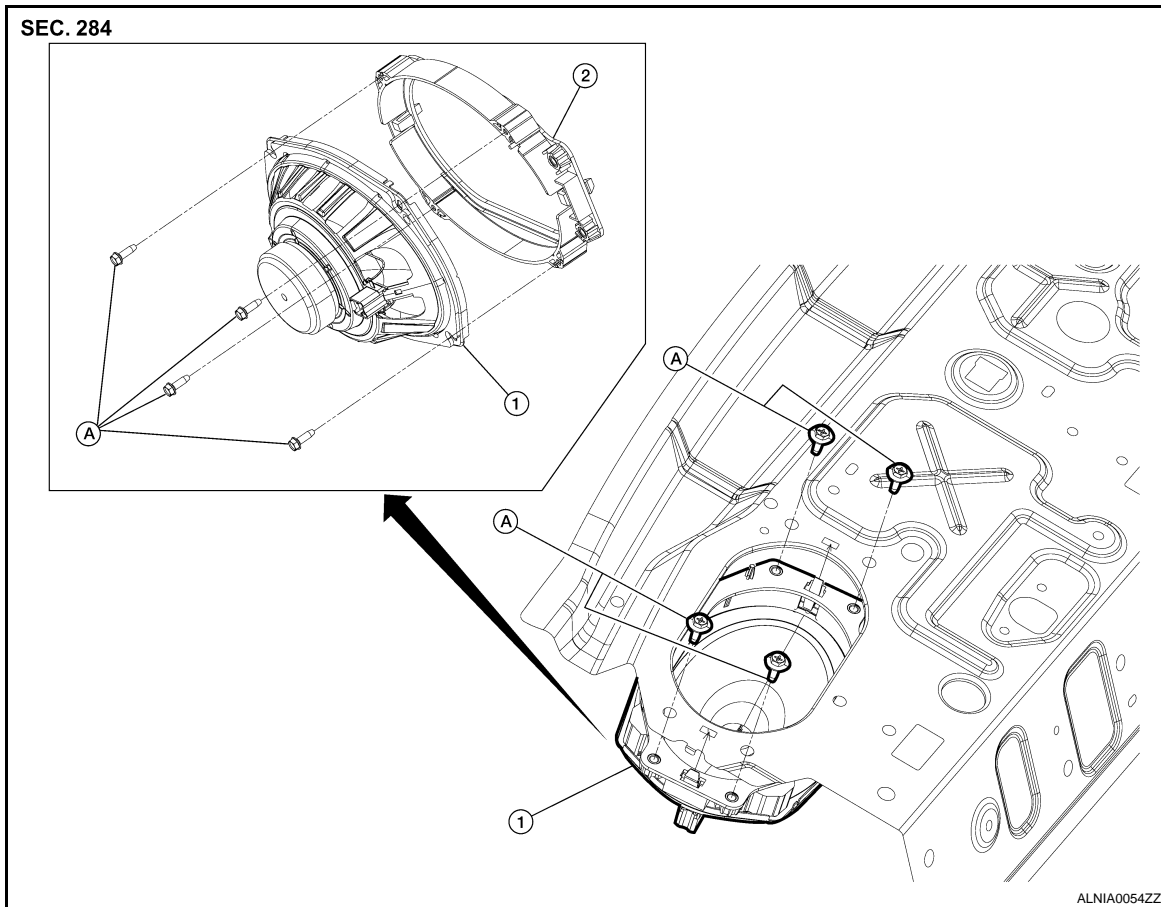

1. Woofer speaker

2. Woofer speaker spacer

A. Screws

Removal and Installation

INFOID:000000001346017

REMOVAL

1. Remove the rear parcel shelf finisher. Refer to [INT-16, "Removal and Installation"](#).
2. Remove the trunk front finisher. Refer to [INT-22, "Removal and Installation"](#).
3. Remove the woofer speaker screws from the top, disconnect the woofer speaker harness connector and remove the woofer speaker and spacer assembly.
4. Remove the spacer screws and remove the woofer speaker from the spacer.

INSTALLATION

Installation is in the reverse order of removal.

A  
B  
C  
D  
E  
F  
G  
H  
I  
J  
K  
L  
M  
AV  
O  
P

# SATELLITE RADIO TUNER

< ON-VEHICLE REPAIR >

[BOSE AUDIO WITHOUT NAVIGATION]

## SATELLITE RADIO TUNER

### Removal and Installation - Coupe

INFOID:000000003185280

#### REMOVAL

1. Disconnect the battery negative terminal.
2. Remove the trunk floor carpet and spare tire cover. Refer to [INT-22, "Removal and Installation"](#).
3. Remove the LH trunk floor spacer.
4. Remove the Bluetooth control unit screws (A), then disconnect the Bluetooth control unit connectors and remove the Bluetooth control unit (1).
5. Remove the satellite radio tuner assembly nuts (C), and satellite radio tuner screw (D), disconnect the satellite radio tuner harness connectors and remove the satellite radio tuner and bracket assembly (2 and 3), then remove the satellite radio tuner screws (B) and remove satellite radio tuner (2) from the bracket (3).

#### NOTE:

Bluetooth control unit (1) is removed with the satellite radio tuner (2) (if equipped).

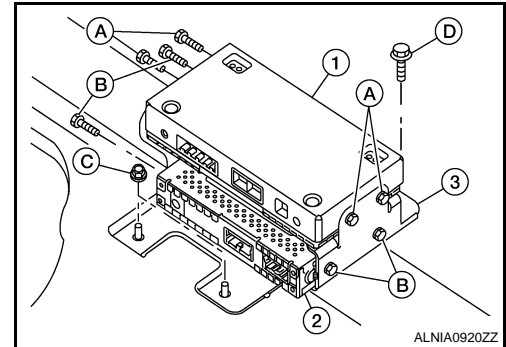

#### INSTALLATION

Installation is in the reverse order of removal.

### Removal and Installation - Sedan

INFOID:000000003185281

#### REMOVAL

1. Disconnect the battery negative terminal.
2. Remove the rear parcel shelf finisher. Refer to [INT-36, "Removal and Installation"](#).
3. Remove the satellite radio tuner unit screws (A), disconnect the satellite tuner harness connectors and remove the satellite radio tuner (1).

#### NOTE:

Bluetooth control unit (2) is removed with the satellite radio tuner unit (if equipped).

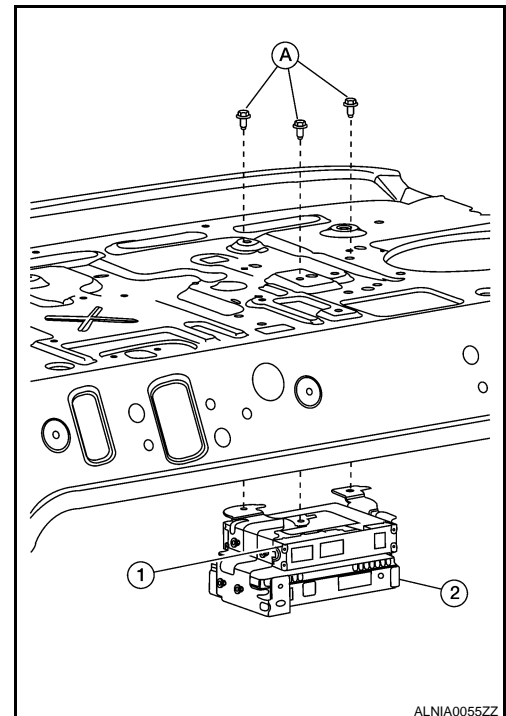

#### INSTALLATION

Installation is in the reverse order of removal.

# SATELLITE RADIO ANTENNA

< ON-VEHICLE REPAIR >

[BOSE AUDIO WITHOUT NAVIGATION]

## SATELLITE RADIO ANTENNA

### Removal and Installation

INFOID:000000001346019

#### REMOVAL

1. Lower the headliner at the rear. Refer to [INT-19. "Removal and Installation"](#).
2. Remove the satellite radio antenna nut (A), then disconnect the satellite radio antenna connector (B) and remove the satellite radio antenna (1).

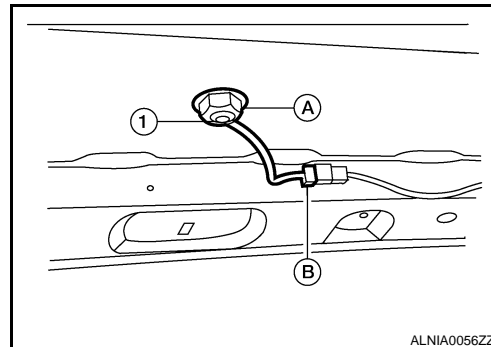

ALNIA0056ZZ

#### INSTALLATION

Installation is in the reverse order of removal.

A  
B  
C  
D  
E  
F  
G  
H  
I  
J  
K  
L  
M

AV

O  
P

# STEERING SWITCH

< ON-VEHICLE REPAIR >

[BOSE AUDIO WITHOUT NAVIGATION]

## STEERING SWITCH

### Removal and Installation

INFOID:000000001744741

#### REMOVAL

1. Remove the driver airbag module. Refer to [SR-4, "Removal and Installation"](#).
2. Remove the steering wheel switch assembly screws (A), then remove the steering wheel switches (1).

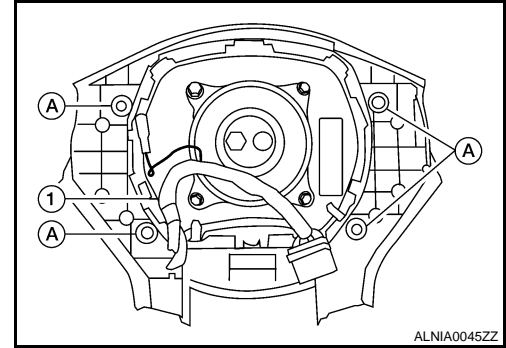

#### INSTALLATION

Installation is in the reverse order of removal.

# AUDIO ANTENNA (COUPE)

< ON-VEHICLE REPAIR >

[BOSE AUDIO WITHOUT NAVIGATION]

## AUDIO ANTENNA (COUPE)

### Location of Antenna

INFOID:000000003185299

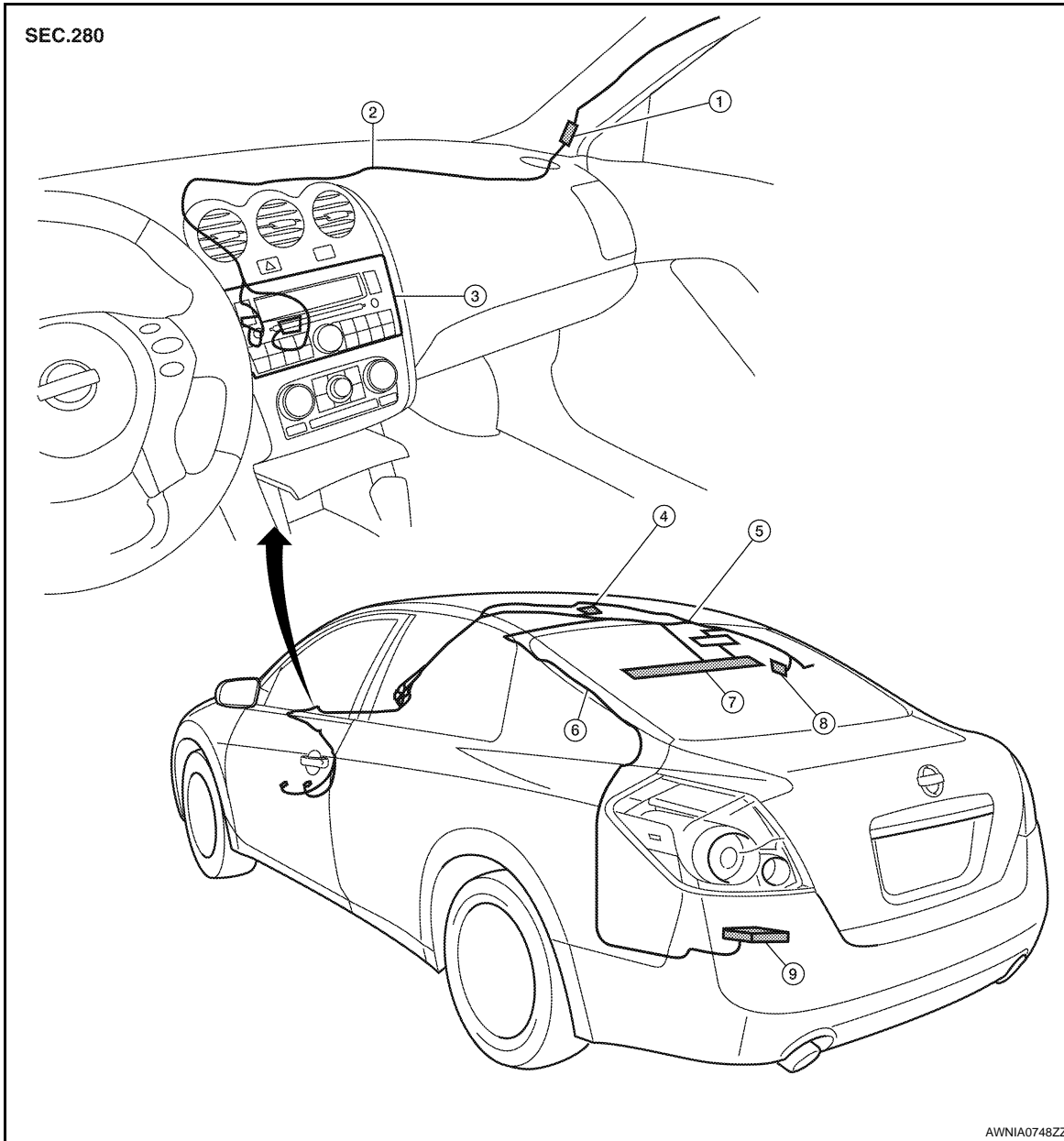

1. In-line connectors M87, M501

2. Audio unit harness

3. Audio unit

4. Satellite antenna

5. Audio antenna feeder

6. Satellite radio antenna feeder

7. Window Antenna

8. Antenna amp.

9. Satellite radio tuner

### Window Antenna Repair

INFOID:000000003185300

### ELEMENT CHECK

A  
B  
C  
D  
E  
F  
G  
H  
I  
J  
K  
L  
M  
AV  
O  
P

# AUDIO ANTENNA (COUPE)

[BOSE AUDIO WITHOUT NAVIGATION]

< ON-VEHICLE REPAIR >

1. Attach probe circuit tester (ohm setting) to antenna terminal on each side.

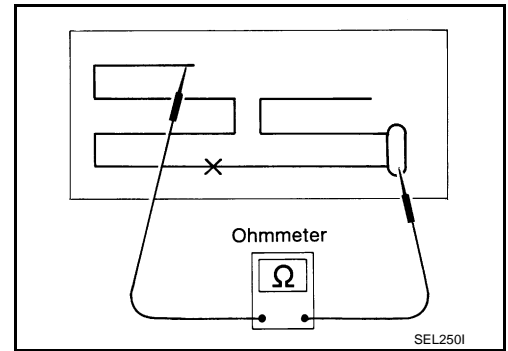

- When measuring continuity, wrap tin foil around the top of probe. Then, press the foil against the wire with your finger.

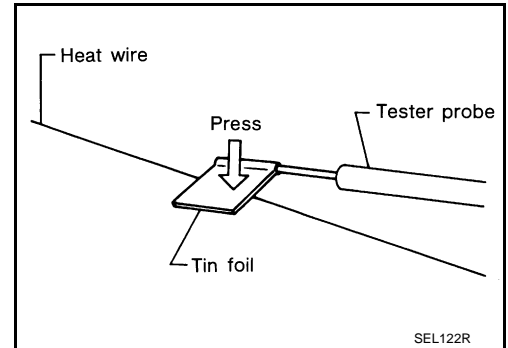

2. If an element is broken, no continuity will exist.

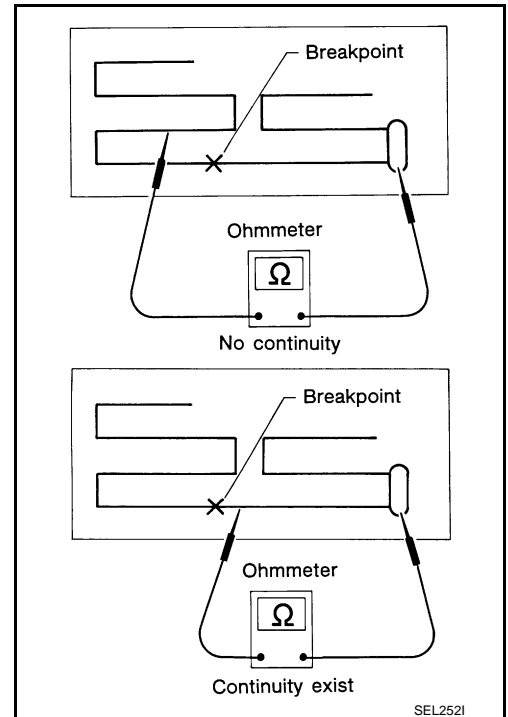

3. To locate a break, move probe along element. Tester indication will change abruptly when probe passes the broken point.

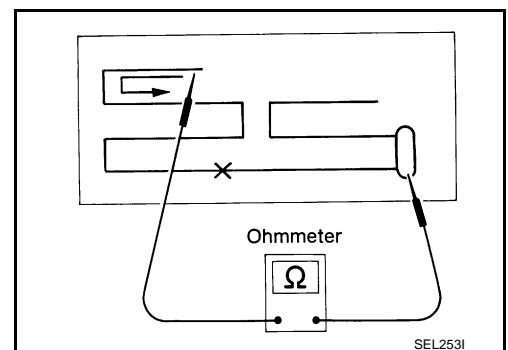

# AUDIO ANTENNA (COUPE)

[BOSE AUDIO WITHOUT NAVIGATION]

< ON-VEHICLE REPAIR >

## REPAIR EQUIPMENT

- Conductive silver composition (DuPont No. 4817 or equivalent)
- Ruler 30 cm (11.8 in) long
- Drawing pen
- Heat gun
- Alcohol
- Cloth

## REPAIRING PROCEDURE

1. Wipe broken heat wire and its surrounding area clean with a cloth dampened in alcohol.
2. Apply a small amount of conductive silver composition to tip of drawing pen. Shake silver composition container before use.
3. Place ruler on glass along broken line. Deposit conductive silver composition on break with drawing pen. Slightly overlap existing heat wire on both sides [preferably 5 mm (0.20 in)] of the break.

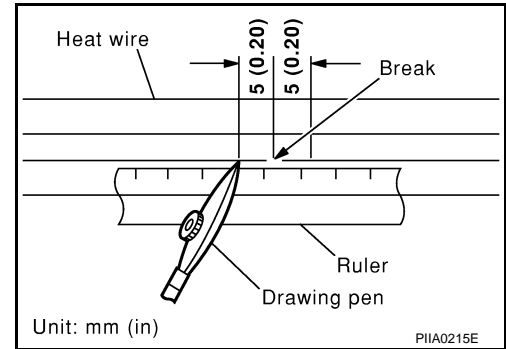

4. After repair has been completed, check repaired wire for continuity. This check should be conducted 10 minutes after silver composition is deposited. Do not touch repaired area while test is being conducted.

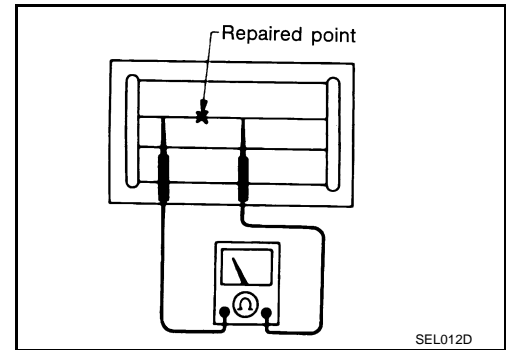

5. Apply a constant stream of hot air directly to the repaired area for approximately 20 minutes with a heat gun. A minimum distance of 3 cm (1.2 in) should be kept between repaired area and hot air outlet. If a heat gun is not available, let the repaired area dry for 24 hours.

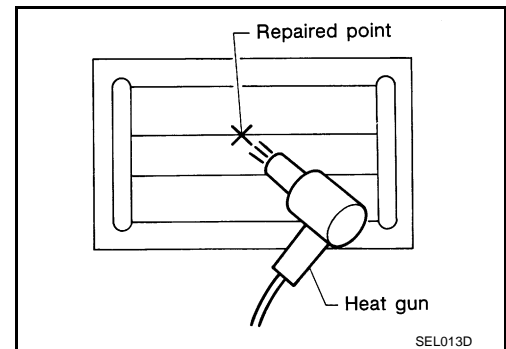

A  
B  
C  
D  
E  
F  
G  
H  
I  
J  
K  
L  
M  
AV  
O  
P

# AUDIO ANTENNA (SEDAN)

< ON-VEHICLE REPAIR >

[BOSE AUDIO WITHOUT NAVIGATION]

## AUDIO ANTENNA (SEDAN)

### Location of Antenna

INFOID:000000003222309

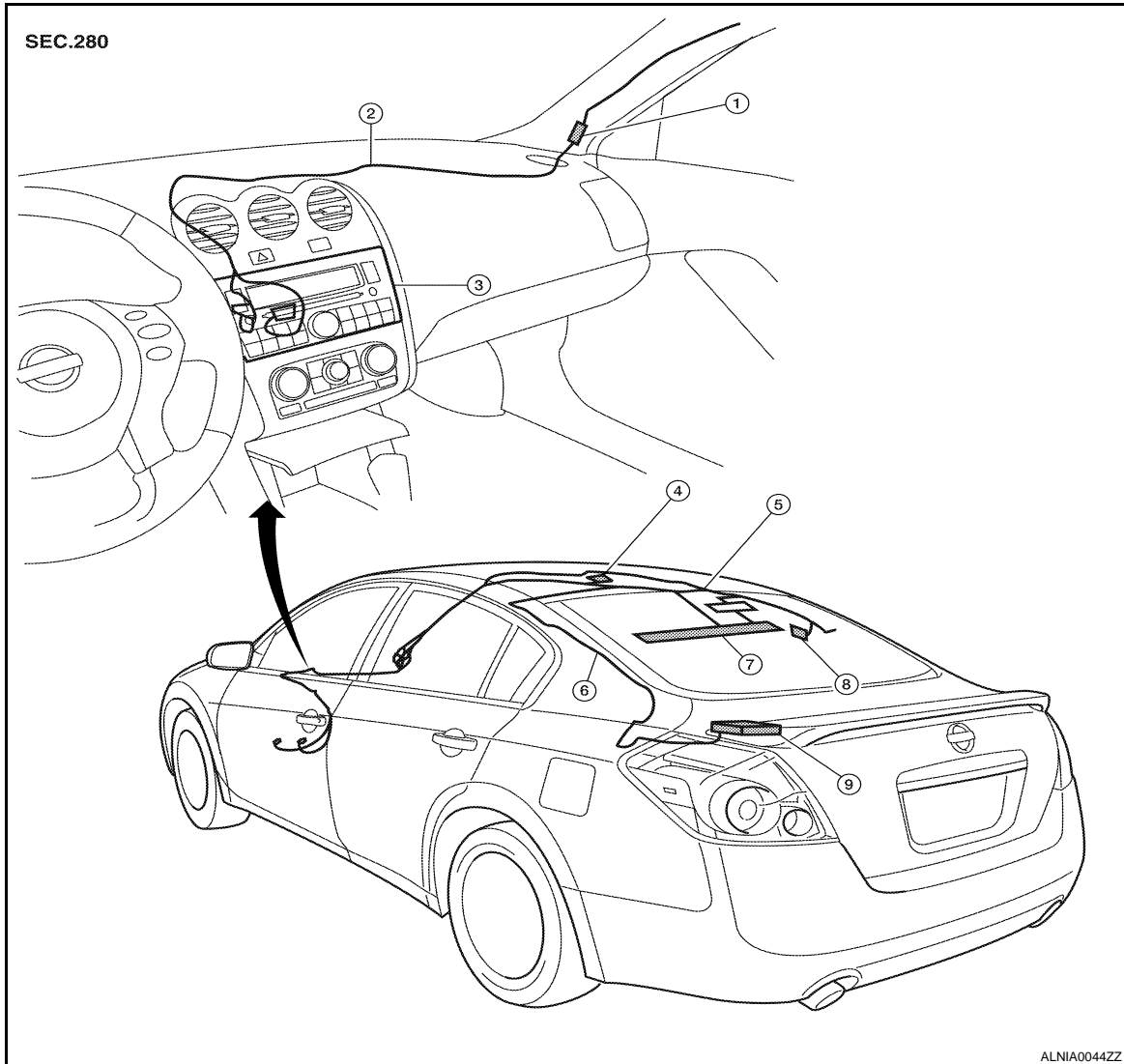

- |                                 |                         |                                   |
|---------------------------------|-------------------------|-----------------------------------|
| 1. In-line connectors M87, M501 | 2. Audio unit harness   | 3. Audio unit                     |
| 4. Satellite antenna            | 5. Audio antenna feeder | 6. Satellite radio antenna feeder |
| 7. Window Antenna               | 8. Antenna amp.         | 9. Satellite radio tuner          |

### Window Antenna Repair

INFOID:000000003222310

#### ELEMENT CHECK

1. Attach probe circuit tester (ohm setting) to antenna terminal on each side.

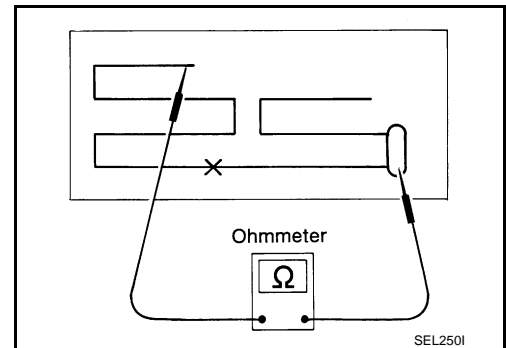



# AUDIO ANTENNA (SEDAN)

[BOSE AUDIO WITHOUT NAVIGATION]

< ON-VEHICLE REPAIR >

- When measuring continuity, wrap tin foil around the top of probe. Then, press the foil against the wire with your finger.

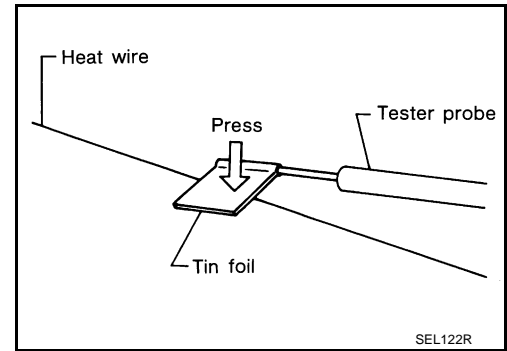

2. If an element is broken, no continuity will exist.

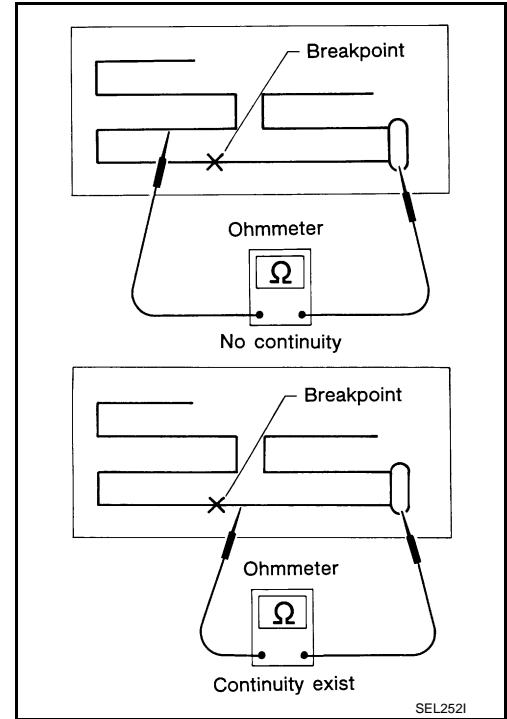

3. To locate a break, move probe along element. Tester indication will change abruptly when probe passes the broken point.

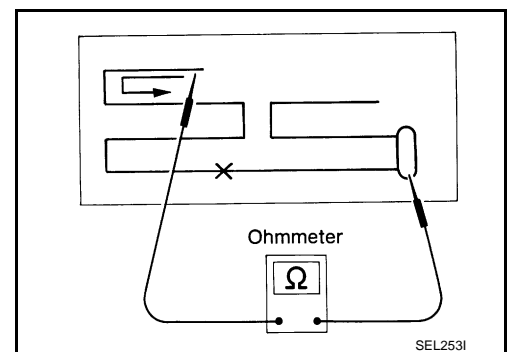

## REPAIR EQUIPMENT

- Conductive silver composition (DuPont No. 4817 or equivalent)
- Ruler 30 cm (11.8 in) long
- Drawing pen
- Heat gun
- Alcohol
- Cloth

## REPAIRING PROCEDURE

A  
B  
C  
D  
E  
F  
G  
H  
I  
J  
K  
L  
M  
N  
O  
P

AV

## AUDIO ANTENNA (SEDAN)

[BOSE AUDIO WITHOUT NAVIGATION]

### < ON-VEHICLE REPAIR >

1. Wipe broken heat wire and its surrounding area clean with a cloth dampened in alcohol.
2. Apply a small amount of conductive silver composition to tip of drawing pen. Shake silver composition container before use.
3. Place ruler on glass along broken line. Deposit conductive silver composition on break with drawing pen. Slightly overlap existing heat wire on both sides [preferably 5 mm (0.20 in)] of the break.

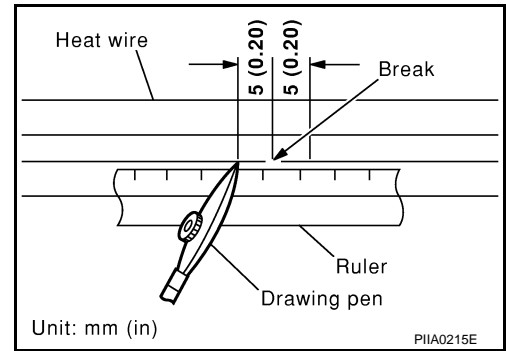

4. After repair has been completed, check repaired wire for continuity. This check should be conducted 10 minutes after silver composition is deposited.  
Do not touch repaired area while test is being conducted.

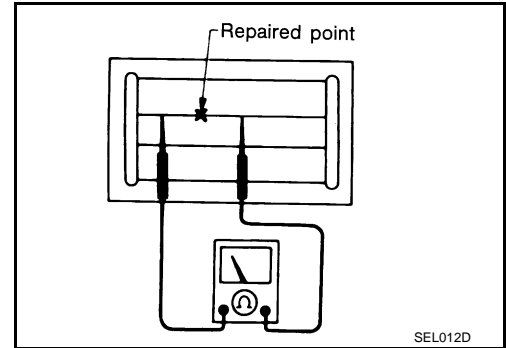

5. Apply a constant stream of hot air directly to the repaired area for approximately 20 minutes with a heat gun. A minimum distance of 3 cm (1.2 in) should be kept between repaired area and hot air outlet.  
If a heat gun is not available, let the repaired area dry for 24 hours.

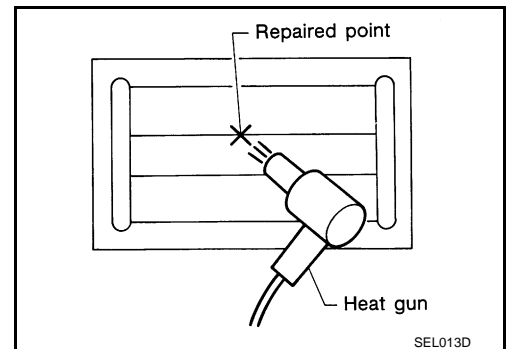

# ANTENNA AMP.

< ON-VEHICLE REPAIR >

[BOSE AUDIO WITHOUT NAVIGATION]

## ANTENNA AMP.

### Removal and Installation - Coupe

INFOID:000000003185302

#### REMOVAL

1. Remove the rear pillar finisher RH. Refer to [INT-19, "Exploded View"](#).
2. Detach the antenna amp harness clip (B), disconnect the antenna amp connectors (A), remove the antenna amp screw (C) and remove the antenna amp (1).

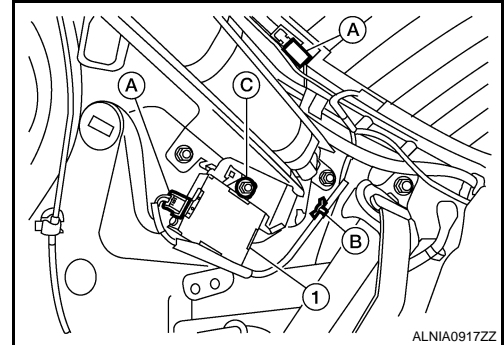

#### INSTALLATION

Installation is in the reverse order of removal.

### Removal and Installation - Sedan

INFOID:000000003185303

#### REMOVAL

1. Remove the rear pillar finisher RH. Refer to [INT-40, "Exploded View"](#).
2. Partially remove the side curtain air bag module RH to gain access to the antenna amp. Refer to [SR-10, "Removal and Installation"](#).
3. Detach the antenna amp harness clip (A), disconnect the antenna amp connectors (B), remove the antenna amp screw (C) and remove the antenna amp (1).

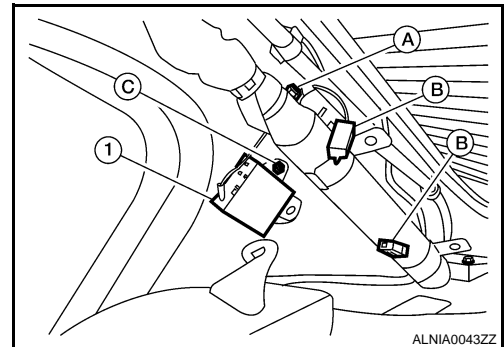

#### INSTALLATION

Installation is in the reverse order of removal.

A  
B  
C  
D  
E  
F  
G  
H  
I  
J  
K  
L  
M  
O  
P

AV

# MICROPHONE

< ON-VEHICLE REPAIR >

[BOSE AUDIO WITHOUT NAVIGATION]

## MICROPHONE

### Removal and Installation - Coupe

INFOID:000000003185304

#### REMOVAL - WITH SUNROOF

1. Remove the map lamp assembly. Refer to [INT-19, "Exploded View"](#).
2. Detach the microphone connector (A).

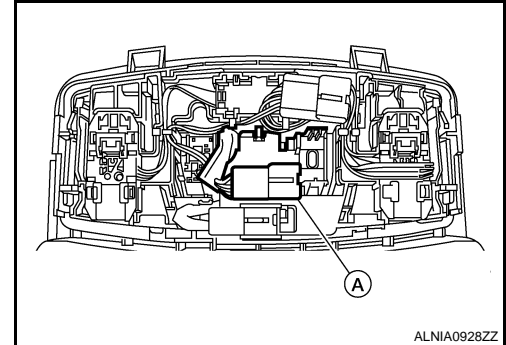

3. Remove the map lamp covers (1), then remove the map lamp assembly cover (2).

**NOTE:**

This step and the following step are (non sunroof only).

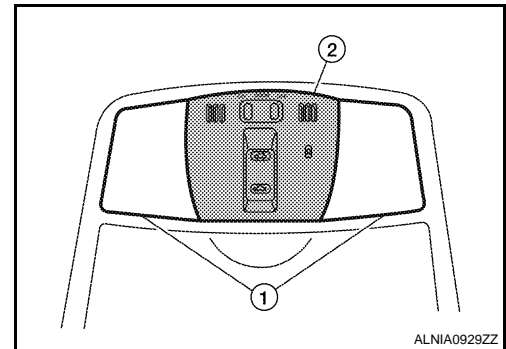

4. Release the microphone tabs (A), then remove the microphone (1).

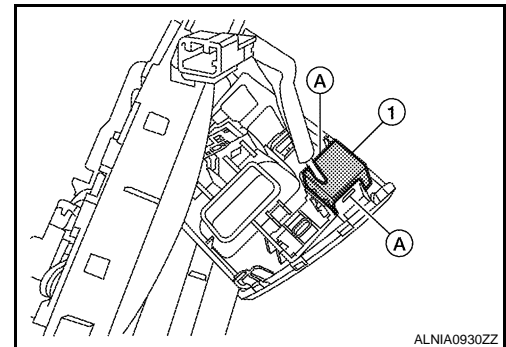

#### INSTALLATION

Installation is in the reverse order of removal.

### Removal and Installation - Sedan

INFOID:000000003185305

#### REMOVAL

1. Remove the map lamp. Refer to [INT-40, "Exploded View"](#).
2. Remove the Bluetooth microphone (2).

# MICROPHONE

[BOSE AUDIO WITHOUT NAVIGATION]

< ON-VEHICLE REPAIR >

- Map lamp (1)

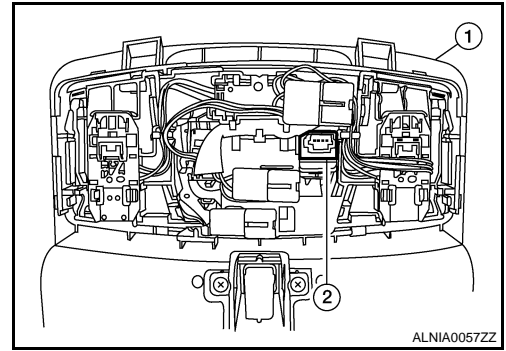

## INSTALLATION

Installation is in the reverse order of removal.

A  
B  
C  
D  
E  
F  
G  
H  
I  
J  
K  
L  
M  
AV  
O  
P

## TEL ANTENNA

### Removal and Installation - Coupe

INFOID:000000003185306

#### REMOVAL

1. Remove the trunk front finisher, trunk floor carpet and spare tire cover. Refer to [INT-21, "Exploded View"](#).
2. Remove the LH trunk floor spacer.
3. Remove the rear pillar LH. Refer to [INT-19, "Exploded View"](#).
4. Remove the rear parcel shelf. Refer to [INT-16, "Removal and Installation"](#).
5. Remove the Bluetooth antenna screw (A), then detach the Bluetooth antenna harness clips, disconnect the Bluetooth antenna connector and remove the Bluetooth antenna (1).

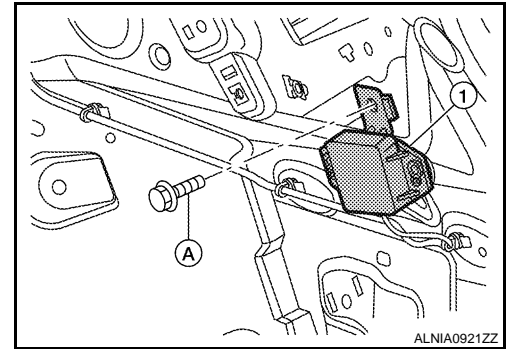

#### INSTALLATION

Installation is in the reverse order of removal.

### Removal and Installation - Sedan

INFOID:000000003185307

#### REMOVAL

1. Remove the rear parcel shelf. Refer to [INT-36, "Removal and Installation"](#).
2. Remove the Bluetooth antenna screw (A), fold down the rear seat, disconnect the Bluetooth antenna connector and remove the Bluetooth antenna (1).

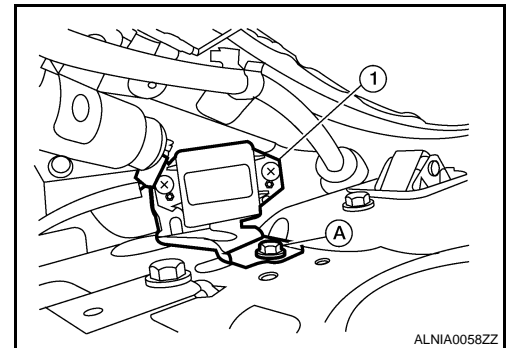

#### INSTALLATION

Installation is in the reverse order of removal.

# BLUETOOTH CONTROL UNIT

[BOSE AUDIO WITHOUT NAVIGATION]

< ON-VEHICLE REPAIR >

## BLUETOOTH CONTROL UNIT

### Removal and Installation - Coupe

INFOID:000000003185332

#### REMOVAL

1. Disconnect the battery negative terminal.
2. Remove the trunk floor carpet and spare tire cover. Refer to [INT-21, "Exploded View"](#).
3. Remove the LH trunk floor spacer.
4. Remove the Bluetooth control unit screws (A), disconnect the Bluetooth control unit connectors and remove the Bluetooth control unit (1).
  - Satellite radio tuner (2)
  - Satellite radio tuner screws (B)
  - Satellite radio tuner bracket (3)
  - Satellite radio tuner bracket nuts (C)
  - Satellite radio tuner bracket screw (D)

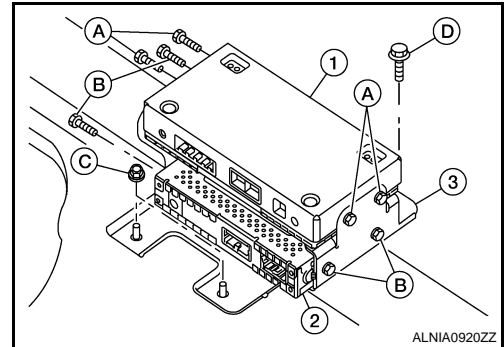

#### INSTALLATION

Installation is in the reverse order of removal.

### Removal and Installation - Sedan

INFOID:000000003185333

#### REMOVAL

1. Remove the rear parcel shelf. Refer to [INT-36, "Removal and Installation"](#).
2. Remove the Bluetooth control unit screws (A), disconnect the Bluetooth control unit connectors and remove the Bluetooth control unit (2).
  - Satellite radio tuner (1)

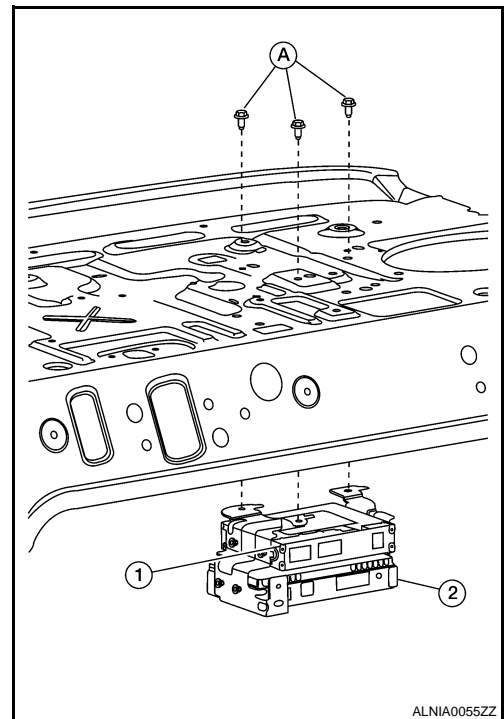

#### INSTALLATION

Installation is in the reverse order of removal.

A  
B  
C  
D  
E  
F  
G  
H  
I  
J  
K  
L  
M  
AV  
O  
P

## BASIC INSPECTION

### DIAGNOSIS AND REPAIR WORKFLOW

#### Work Flow

INFOID:000000001830453

#### OVERALL SEQUENCE

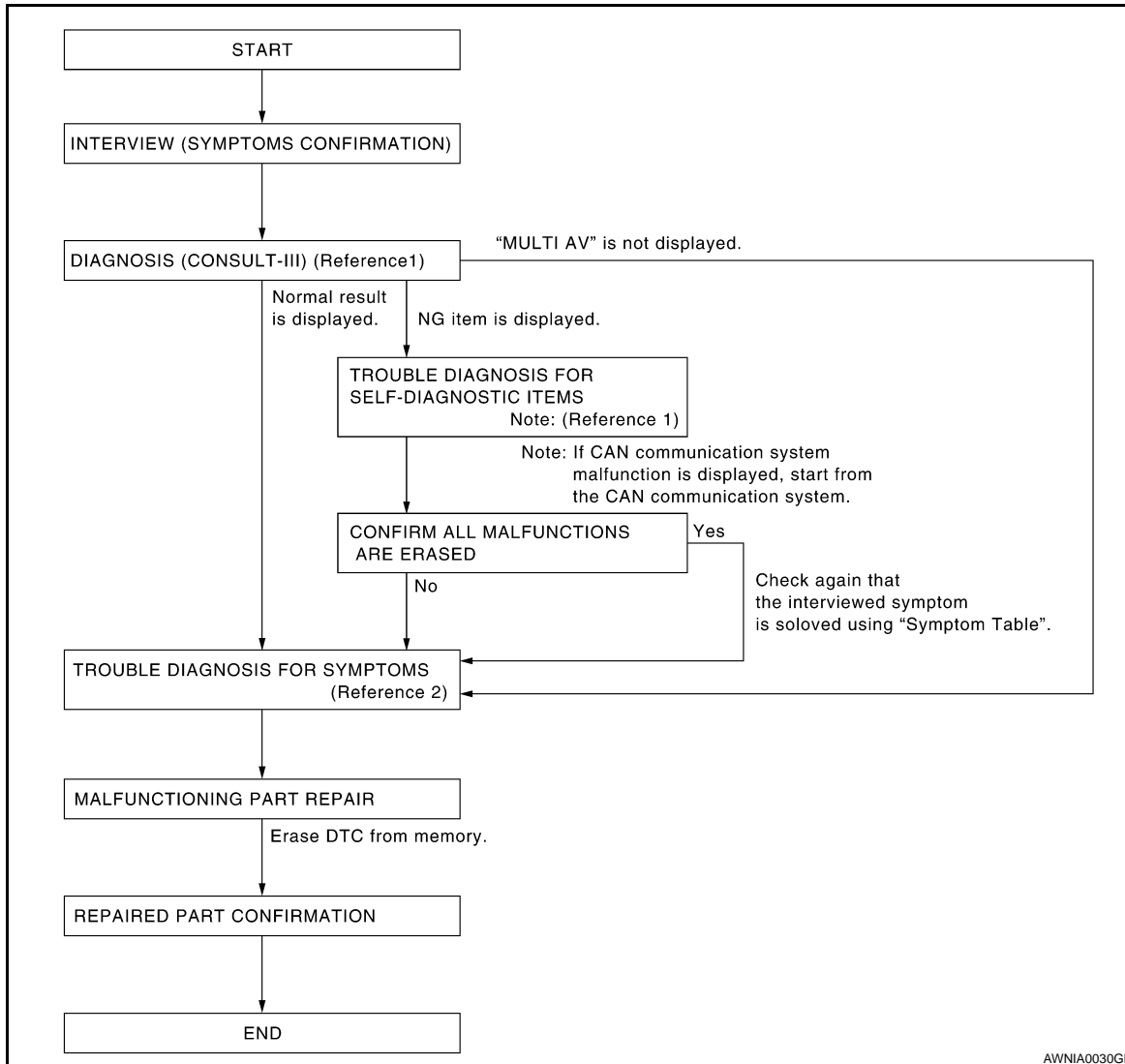

- Reference 1... Refer to [AV-281, "CONSULT - III Function \(MULTI AV\)"](#).
- Reference 2... Refer to [AV-411, "Symptom Table"](#).

#### DETAILED FLOW

##### 1. CHECK SYMPTOM

Check the malfunction symptoms by performing the following items.

- Interview the customer to obtain the malfunction information (conditions and environment when the malfunction occurred).
- Check the symptom.

>> GO TO 2

##### 2. SELF-DIAGNOSIS (CONSULT-III)

1. Connect CONSULT-III and perform "SELF-DIAGNOSIS" for "MULTI AV".  
**NOTE:**  
Skip to step 4 of the diagnosis procedure if "MULTI AV" is not displayed.
2. Check if any DTC No. is displayed in the self-diagnosis results.



# DIAGNOSIS AND REPAIR WORKFLOW

[BOSE AUDIO WITH NAVIGATION]

< BASIC INSPECTION >

Is any DTC No. displayed?

- YES >> GO TO 3
- NO >> GO TO 4

## 3.CHECK SELF-DIAGNOSIS RESULTS (CONSULT-III)

1. Check the DTC No. indicated in the self-diagnosis results.
2. Perform the relevant diagnosis referring to the DTC No. list. Refer to [AV-377, "DTC Index"](#).

### NOTE:

Start with the diagnosis for the CAN communication system if "CAN COMM CIRCUIT [U1000] or CONTROL UNIT (CAN) [U1010]" is displayed.

>> GO TO 5

## 4.PERFORM DIAGNOSIS BY SYMPTOM

Perform the relevant diagnosis referring to the diagnosis chart by symptom. Refer to [AV-411, "Symptom Table"](#).

>> GO TO 5

## 5.REPAIR OR REPLACE MALFUNCTIONING PARTS

Repair or replace the identified malfunctioning parts.

### NOTE:

Erase the stored self-diagnosis results after repairing or replacing the relevant components if any DTC No. has been indicated in the self-diagnosis results.

>> GO TO 6

## 6.CHECK AFTER REPAIR

1. Perform self-diagnosis for "MULTI AV" with CONSULT-III after repairing or replacing the malfunctioning parts.
2. Check if any DTC No. is displayed in the self-diagnosis results.

Is any DTC No. displayed?

- YES >> GO TO 3
- NO >> GO TO 7

## 7.FINAL CHECK

Perform the operation check to confirm that the malfunction symptom is solved or that any other symptoms are present.

Are any symptoms present?

- YES >> GO TO 4
- NO >> Inspection End.

A  
B  
C  
D  
E  
F  
G  
H  
I  
J  
K  
L  
M  
O  
P

AV

## INSPECTION AND ADJUSTMENT

### REAR VIEW MONITOR GUIDING LINE ADJUSTMENT

#### REAR VIEW MONITOR GUIDING LINE ADJUSTMENT : Description

INFOID:000000001830454

This mode is used to modify the side distance guidelines if they are dislocated from the rear view monitor image, because of variations of body/camera mounting conditions.

#### REAR VIEW MONITOR GUIDING LINE ADJUSTMENT : Special Repair Requirement

INFOID:000000001830455

1. Create a correction line to modify the screen.  
 Draw lines on the rearward of the vehicle passing through the following points: 200 mm (7.87 inch) from both sides of the vehicle, and
  - \*1: 0.5 m (1.5 feet)
  - \*2: 1 m (3 feet)
  - \*3: 2 m (7 feet)
  - \*4: 3 m (10 feet)
 and from the rear end of the bumper
2. With the ignition switch OFF, connect CONSULT-III, then turn ignition switch ON. Select "REARVIEW CAMERA".

**CAUTION:**

**Stop engine for safety when correcting side distance guideline.**

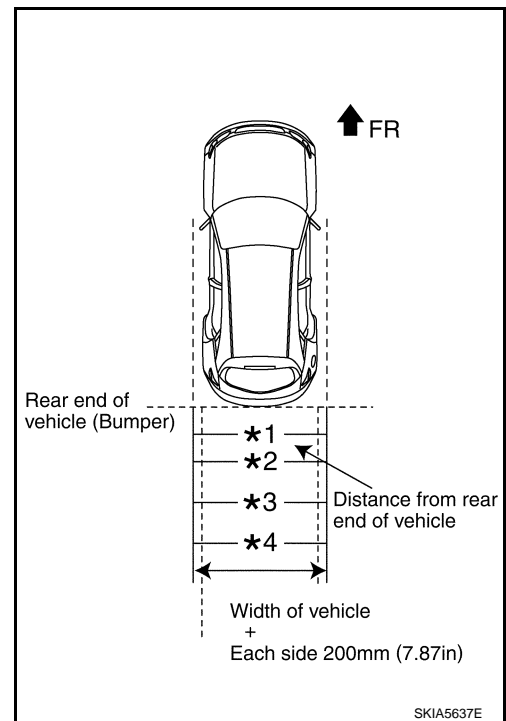

3. Shift the selector lever to R position.

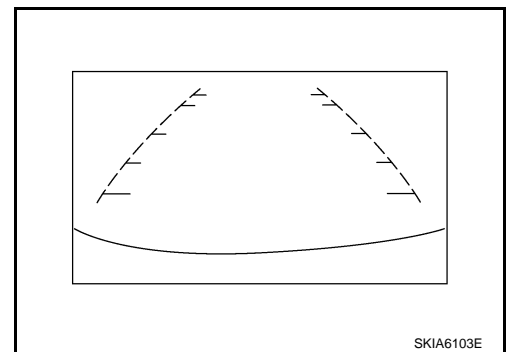

4. Touch "SELCT GUIDELINE PATTERN" under "WORK SUPPORT" menu.
5. Touch "UP" or "DOWN", and select the guide line, "PATTERN NO. 0" or "PATTERN NO. 1", which is the closest to the corrected line.
6. Touch "SAVE", and confirm the guide line.
7. Touch "END".
8. Touch "ADJ GUIDELINE POSITION" under the "WORK SUPPORT" menu.
9. Adjust the guide line touching "X UP", "X DOWN", "Y UP" or "Y DOWN" so that the corrected line can fit the guide line.
10. Touch "SAVE", and confirm the guide line.

# INSPECTION AND ADJUSTMENT

< BASIC INSPECTION >

[BOSE AUDIO WITH NAVIGATION]

---

11. Touch "END" to finish correcting.

A

B

C

D

E

F

G

H

I

J

K

L

M

AV

O

P

# FUNCTION DIAGNOSIS

## MULTI AV SYSTEM (COUPE)

### System Diagram

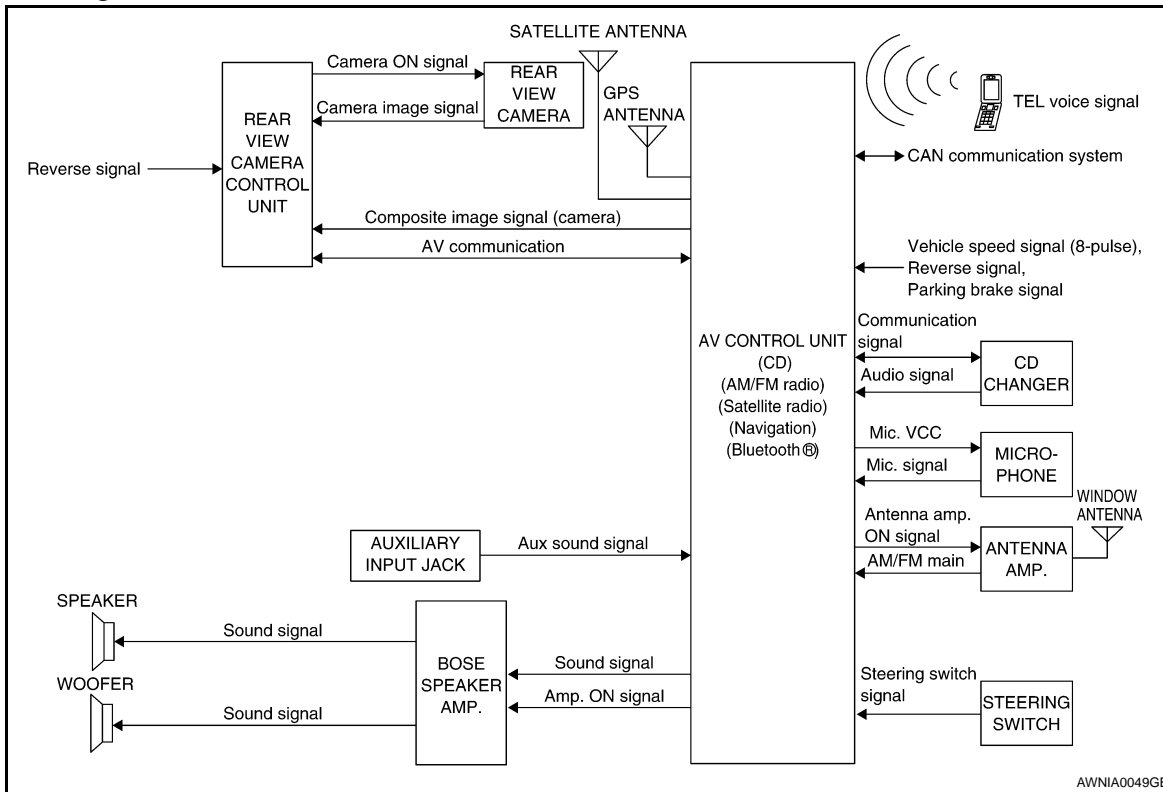

### System Description

INFOID:000000001830457

The multi AV system consists of the following systems.

- Navigation system
- Audio system
- Rear view monitor
- Hands-free phone system

Refer to the following table for multi AV system descriptions.

System	Reference page
Navigation system	<a href="#">AV-242</a>
Audio system	<a href="#">AV-260</a>
Rear view monitor system	<a href="#">AV-253</a>
Hands-free phone system	<a href="#">AV-267</a>

### VOICE RECOGNITION

The multi AV system uses voice recognition to control functions of the following systems:

- Navigation system

# MULTI AV SYSTEM (COUPE)

< FUNCTION DIAGNOSIS >

[BOSE AUDIO WITH NAVIGATION]

- Hands-free phone system

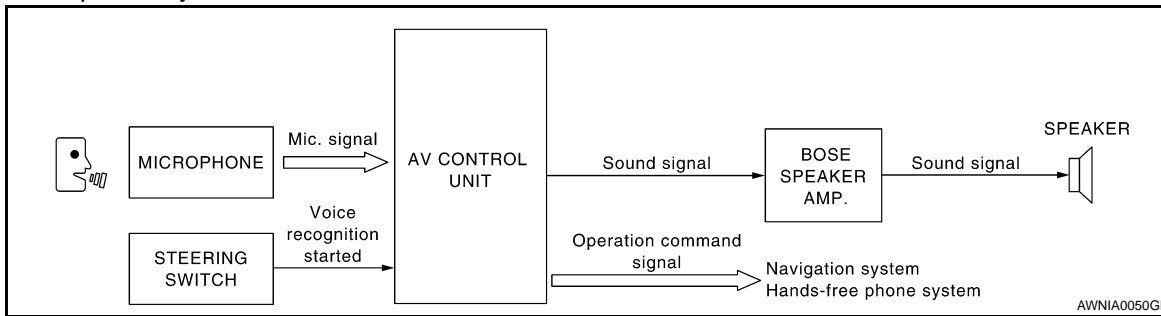

## TOUCH PANEL

The multi AV system uses a touch panel display to control functions of the following systems:

- Audio system
- Navigation system
- Hands-free phone system

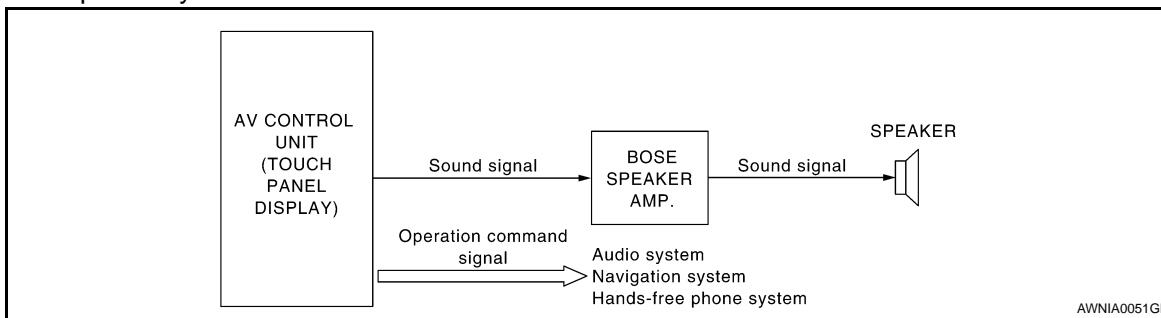

A  
B  
C  
D  
E  
F  
G  
H  
I  
J  
K  
L  
M  
O  
P

AV

# MULTI AV SYSTEM (COUPE)

[BOSE AUDIO WITH NAVIGATION]

< FUNCTION DIAGNOSIS >

## Component Parts Location

INFOID:000000001830458

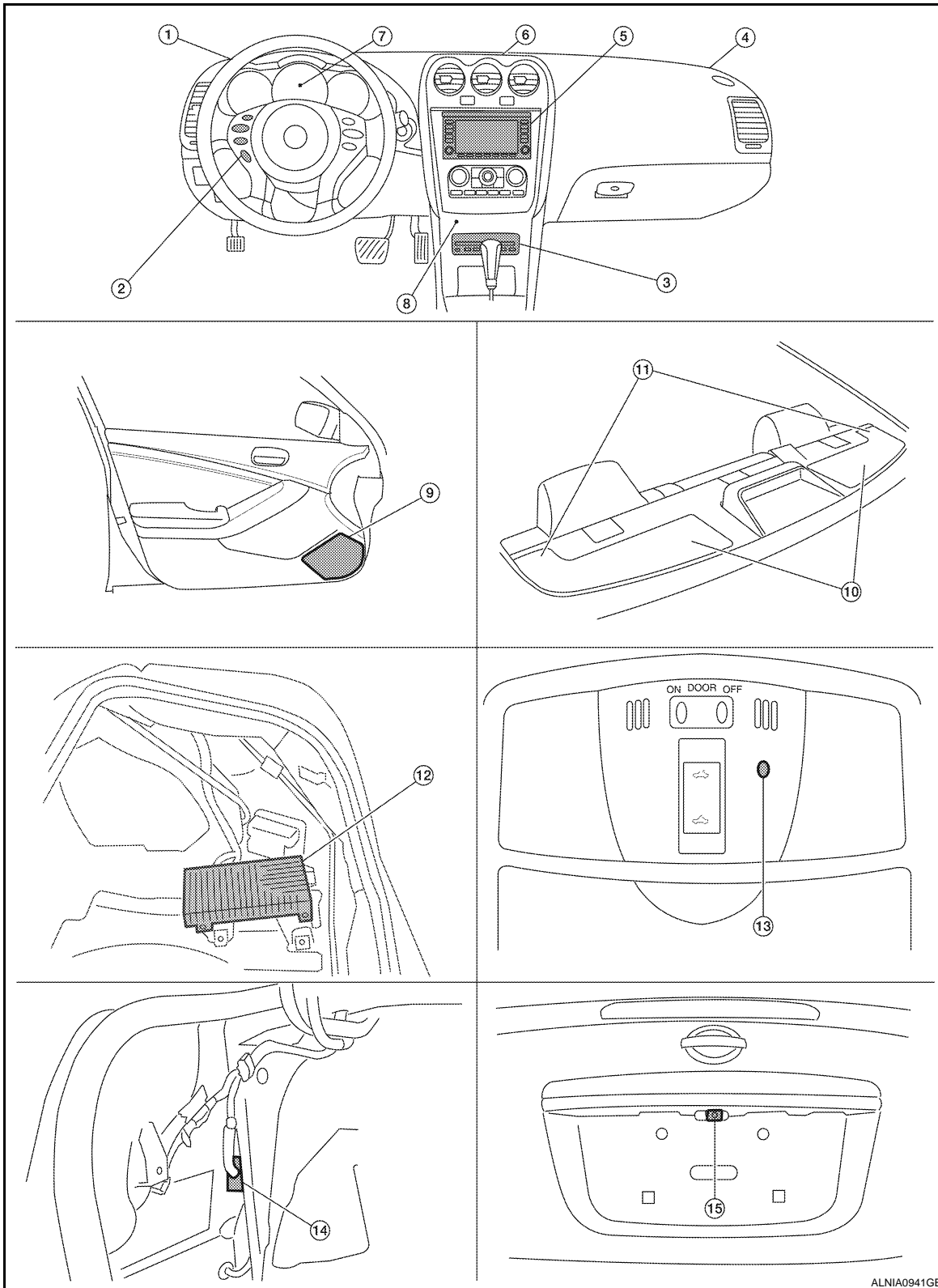

- 1. Front tweeter LH M51
- 4. Front tweeter RH M52

- 2. Steering wheel audio control switches
- 3. CD changer M42
- 5. AV control unit M46, M47, M48, M81, M90, M91
- 6. Center speaker M151

# MULTI AV SYSTEM (COUPE)

< FUNCTION DIAGNOSIS >

[BOSE AUDIO WITH NAVIGATION]

- |  |  |   |
|--|--|---|
| 7. Combination meter M24               | 8. Aux Jack M41  | 9. Door speaker<br>LH D3<br>RH D103   |
| 10. Rear subwoofer<br>LH B25<br>RH B47 | 11. Rear tweeter<br>LH B16<br>RH B100  | 12. BOSE speaker amp. B121, B122 (view with trunk carpet and RH floor spacer removed) |
| 13. Microphone R7                      | 14. Rear view camera control unit B31 (view with trunk side finisher LH removed) | 15. Rear view camera T7   |

## Component Description

INFOID:000000001830459

Part name	Description
AV control unit	<ul style="list-style-type: none"> <li>Integrates DVD-ROM drive allowing map data to be stored</li> <li>The AV control unit includes the navigation, audio, hands-free phone, satellite radio and display functions</li> </ul>
BOSE speaker amp.	Receives power (amp ON) and audio signals from AV control unit, and outputs audio signals to each speaker.
CD changer	Outputs audio signals to AV control unit.
Door speaker	<ul style="list-style-type: none"> <li>Outputs audio signal from BOSE speaker amp.</li> <li>Outputs high, mid and low range sounds</li> </ul>
Front tweeter	<ul style="list-style-type: none"> <li>Outputs audio signal from BOSE speaker amp.</li> <li>Outputs high range sound</li> </ul>
Center speaker	<ul style="list-style-type: none"> <li>Outputs audio signal from BOSE speaker amp.</li> <li>Outputs high, mid and low range sounds</li> </ul>
Rear tweeter	<ul style="list-style-type: none"> <li>Outputs audio signal from BOSE speaker amp.</li> <li>Outputs high range sounds</li> </ul>
Rear subwoofer	<ul style="list-style-type: none"> <li>Outputs audio signal from BOSE speaker amp.</li> <li>Outputs low range sound</li> </ul>
Rear view camera control unit	<ul style="list-style-type: none"> <li>Camera image signal is input from rear view camera, and camera image is indicated on the display</li> <li>Power (camera ON signal) is sent to rear view camera</li> <li>Controlled by AV communication sent from AV control unit</li> <li>AV control unit recognizes the presence of camera system with camera connection recognition signal</li> </ul>
Rear view camera	<ul style="list-style-type: none"> <li>Receives camera ON signal from rear view camera control unit</li> <li>Sends image signal to rear view camera control unit</li> </ul>
Steering wheel audio control switches	<ul style="list-style-type: none"> <li>Operations for audio, hands-free phone and navigation are possible</li> <li>Steering switch signal (operation signal) is output to AV control unit</li> </ul>
Microphone	Voice signals are received and sent to AV control unit.
GPS antenna	GPS signal is received and sent to AV control unit.
Satellite radio antenna	Satellite radio signal is received and sent to AV control unit.

A  
B  
C  
D  
E  
F  
G  
H  
I  
J  
K  
L  
M  
O  
P

AV

# MULTI AV SYSTEM (SEDAN)

< FUNCTION DIAGNOSIS >

[BOSE AUDIO WITH NAVIGATION]

## MULTI AV SYSTEM (SEDAN)

### System Diagram

INFOID:000000003214775

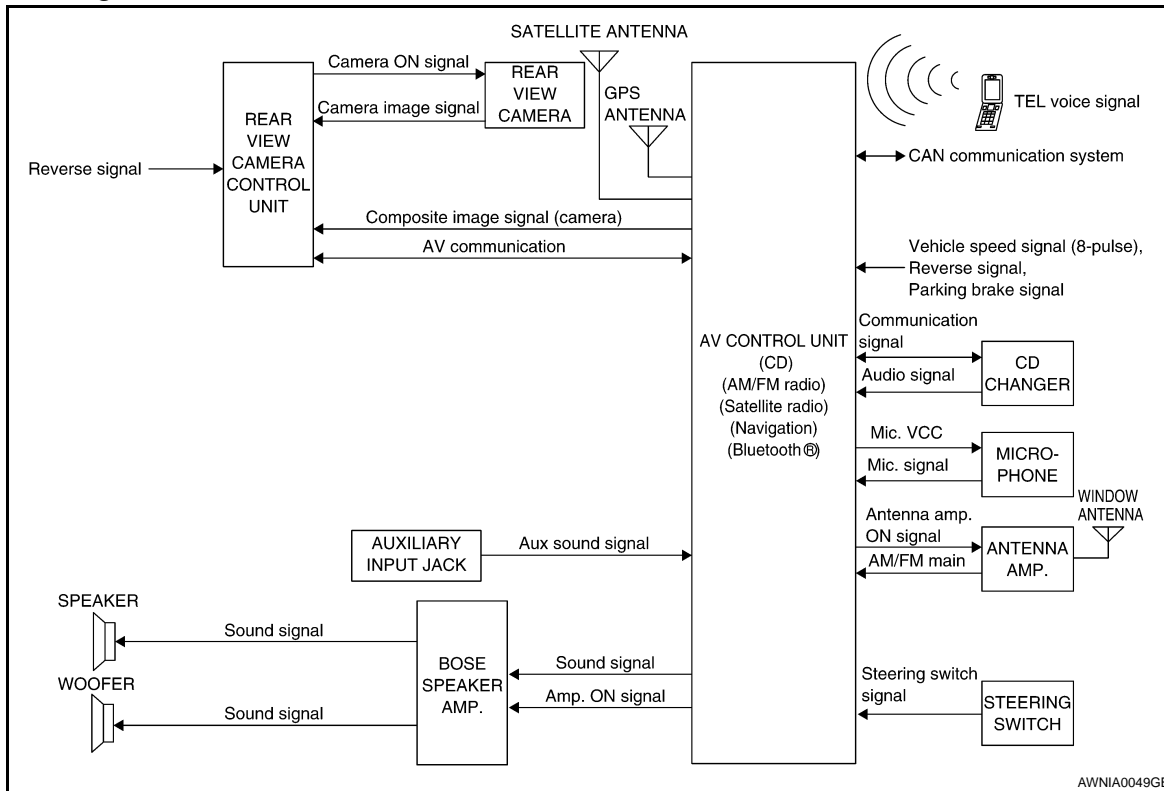

### System Description

INFOID:000000003214776

The multi AV system consists of the following systems.

- Navigation system
- Audio system
- Rear view monitor
- Hands-free phone system

Refer to the following table for multi AV system descriptions.

System	Reference page
Navigation system	<a href="#">AV-247</a>
Audio system	<a href="#">AV-263</a>
Rear view monitor system	<a href="#">AV-256</a>
Hands-free phone system	<a href="#">AV-270</a>

### VOICE RECOGNITION

The multi AV system uses voice recognition to control functions of the following systems:

- Navigation system
- Hands-free phone system

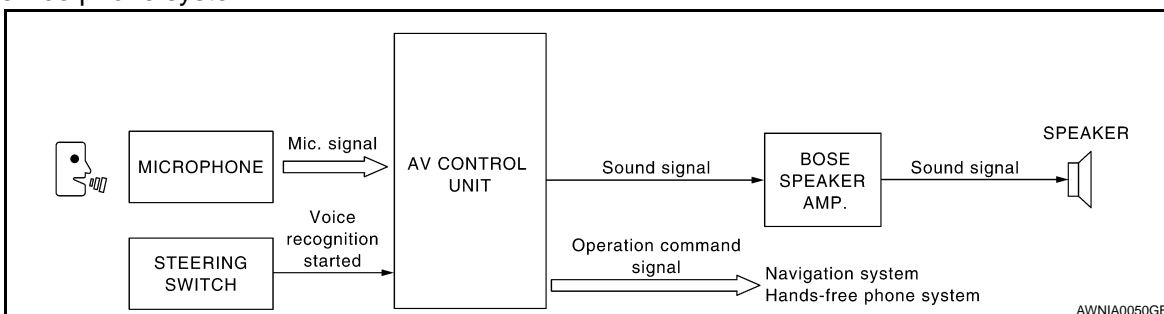



# MULTI AV SYSTEM (SEDAN)

[BOSE AUDIO WITH NAVIGATION]

< FUNCTION DIAGNOSIS >

## TOUCH PANEL

The multi AV system uses a touch panel display to control functions of the following systems:

- Audio system
- Navigation system
- Hands-free phone system

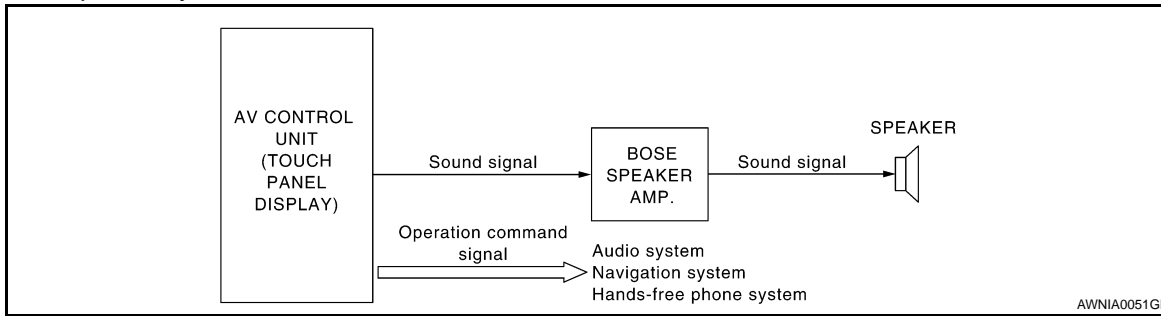

A  
B  
C  
D  
E  
F  
G  
H  
I  
J  
K  
L  
M  
N  
O  
P

AV

# MULTI AV SYSTEM (SEDAN)

< FUNCTION DIAGNOSIS >

[BOSE AUDIO WITH NAVIGATION]

---

Component Parts Location

INFOID:000000003214777

# MULTI AV SYSTEM (SEDAN)

< FUNCTION DIAGNOSIS >

[BOSE AUDIO WITH NAVIGATION]

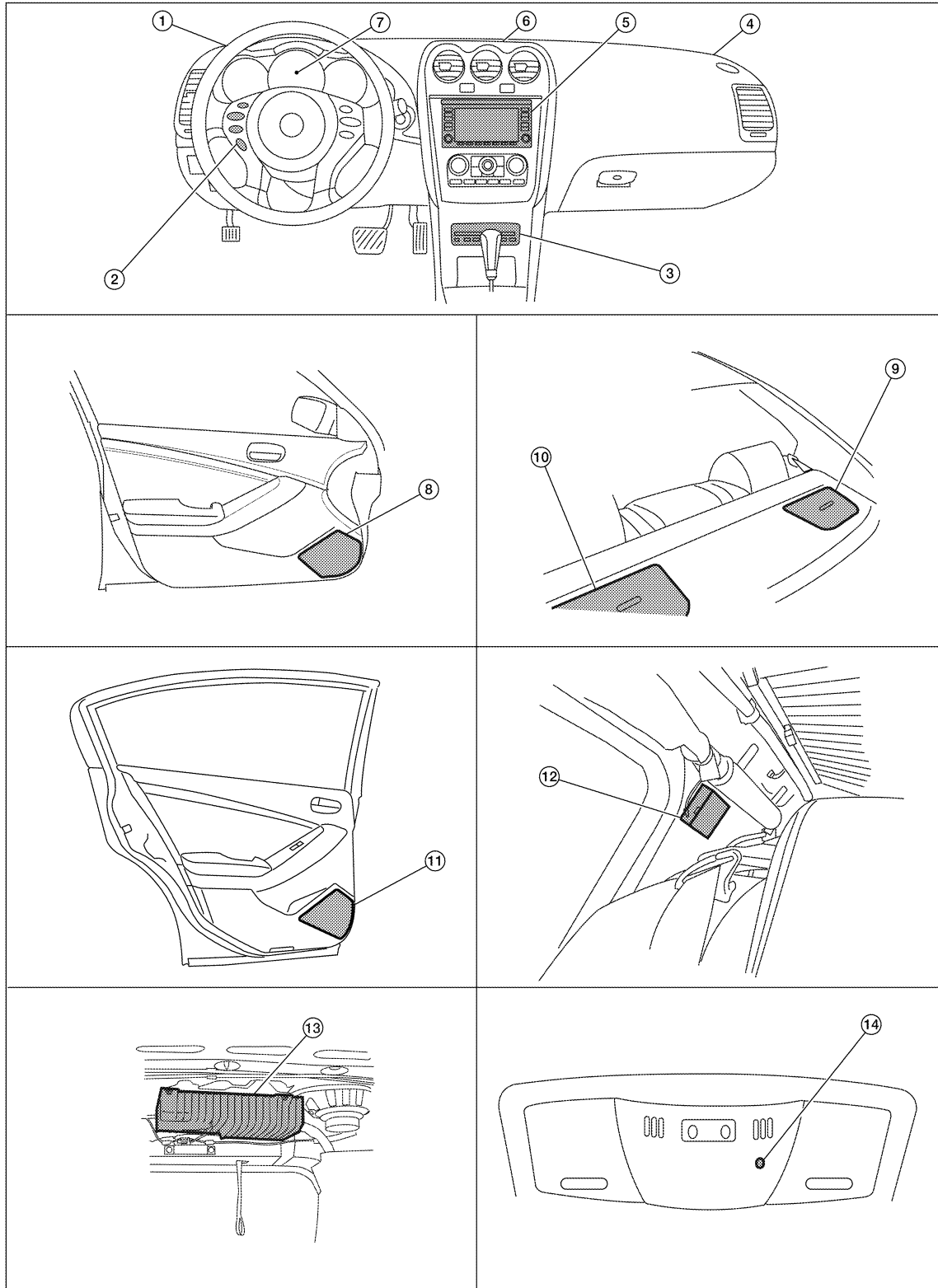

AWN1A0760ZZ

A  
B  
C  
D  
E  
F  
G  
H  
I  
J  
K  
L  
M  
N  
O  
P

AV

# MULTI AV SYSTEM (SEDAN)

< FUNCTION DIAGNOSIS >

[BOSE AUDIO WITH NAVIGATION]

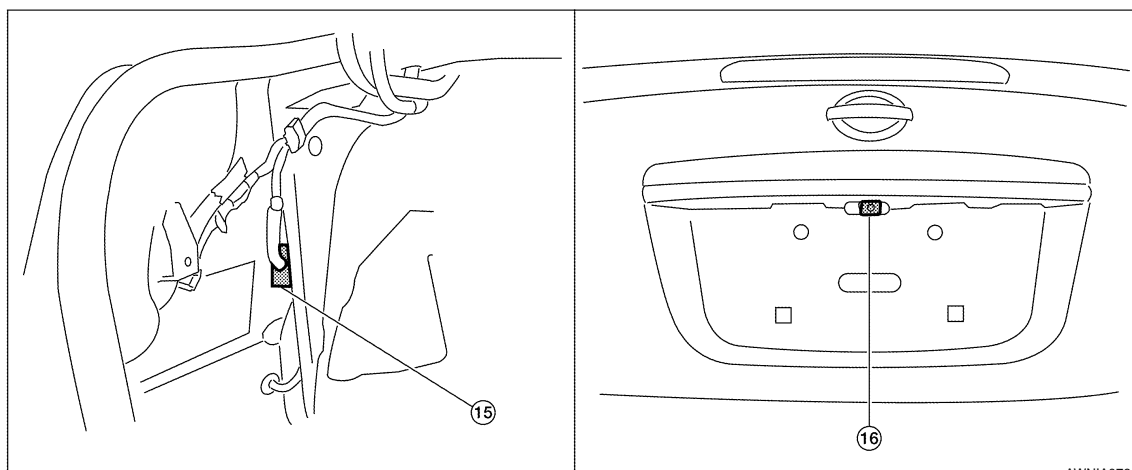

- |                                  |   |  |
|----------------------------------|---|--|
| 1. Tweeter LH M51                | 2. Steering wheel audio control switches        | 3. CD changer M42  |
| 4. Tweeter RH M52                | 5. AV control unit M46, M47, M48, M81, M90, M91 | 6. Center speaker M151   |
| 7. Combination meter M24         | 8. Front door speaker LH D3<br>RH D103          | 9. Rear subwoofer RH B124  |
| 10. Rear subwoofer LH B120       | 11. Rear door speaker LH D202<br>RH D302        | 12. Antenna amp M502 (view with rear pillar finisher RH removed)                 |
| 13. BOSE speaker amp. B121, B122 | 14. Microphone R7                               | 15. Rear view camera control unit B31 (view with trunk side finisher LH removed) |
| 16. Rear view camera B35         |   |  |

## Component Description

INFOID:000000003214778

Part name	Description
AV control unit	<ul style="list-style-type: none"> <li>Integrates DVD-ROM drive allowing map data to be stored</li> <li>The AV control unit includes the navigation, audio, hands-free phone, satellite radio and display functions</li> </ul>
BOSE speaker amp.	Receives power (amp ON) and audio signals from AV control unit, and outputs audio signals to each speaker.
CD changer	Outputs audio signals to AV control unit.
Front door speaker	<ul style="list-style-type: none"> <li>Outputs audio signal from BOSE speaker amp.</li> <li>Outputs high, mid and low range sounds</li> </ul>
Tweeter	<ul style="list-style-type: none"> <li>Outputs audio signal from BOSE speaker amp.</li> <li>Outputs high range sound</li> </ul>
Center speaker	<ul style="list-style-type: none"> <li>Outputs audio signal from BOSE speaker amp.</li> <li>Outputs high, mid and low range sounds</li> </ul>
Rear door speaker	<ul style="list-style-type: none"> <li>Outputs audio signal from BOSE speaker amp.</li> <li>Outputs high, mid and low range sounds</li> </ul>
Rear subwoofer	<ul style="list-style-type: none"> <li>Outputs audio signal from BOSE speaker amp.</li> <li>Outputs low range sound</li> </ul>
Rear view camera control unit	<ul style="list-style-type: none"> <li>Camera image signal is input from rear view camera, and camera image is indicated on the display</li> <li>Power (camera ON signal) is sent to rear view camera</li> <li>Controlled by AV communication sent from AV control unit</li> <li>AV control unit recognizes the presence of camera system with camera connection recognition signal</li> </ul>
Rear view camera	<ul style="list-style-type: none"> <li>Receives camera ON signal from rear view camera control unit</li> <li>Sends image signal to rear view camera control unit</li> </ul>

# MULTI AV SYSTEM (SEDAN)

[BOSE AUDIO WITH NAVIGATION]

< FUNCTION DIAGNOSIS >

Part name	Description
Steering wheel audio control switches	<ul style="list-style-type: none"><li>• Operations for audio, hands-free phone and navigation are possible</li><li>• Steering switch signal (operation signal) is output to AV control unit</li></ul>
Microphone	Voice signals are received and sent to AV control unit.
GPS antenna	GPS signal is received and sent to AV control unit.
Antenna amp.	<ul style="list-style-type: none"><li>• Radio signal received by glass antenna is amplified and sent to AV control unit</li><li>• Power (antenna amp ON signal) is supplied from AV control unit</li></ul>
Satellite radio antenna	Satellite radio signal is received and sent to AV control unit.

A

B

C

D

E

F

G

H

I

J

K

L

M

AV

O

P

## NAVIGATION SYSTEM (COUPE)

### System Diagram

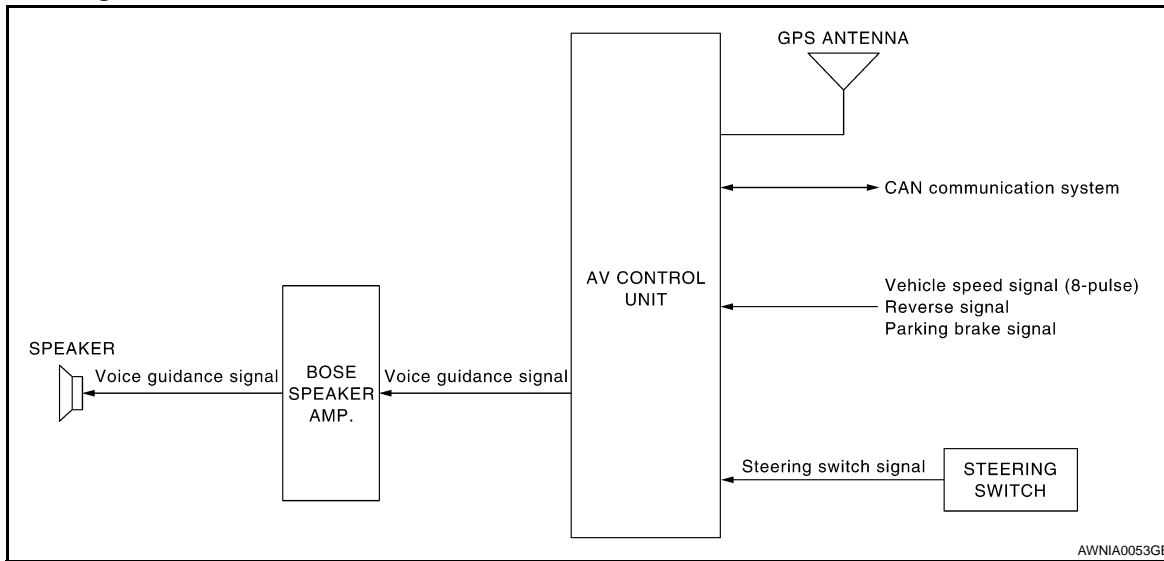

### System Description

INFOID:000000001830461

**NOTE:**

Refer to NAVI System Owner's Manual for system operation.

The navigation system periodically calculates the vehicle's current position according to the following three signals: Travel distance of the vehicle as determined by the vehicle speed sensor, turning angle of the vehicle as determined by the gyroscope (angular velocity sensor), and the direction of vehicle travel as determined by the GPS antenna (GPS information).

The current position of the vehicle is then identified by comparing the calculated vehicle position with map data read from the map DVD-ROM, which is stored in the DVD-ROM drive (map-matching), and indicated on the screen with a current-location mark.

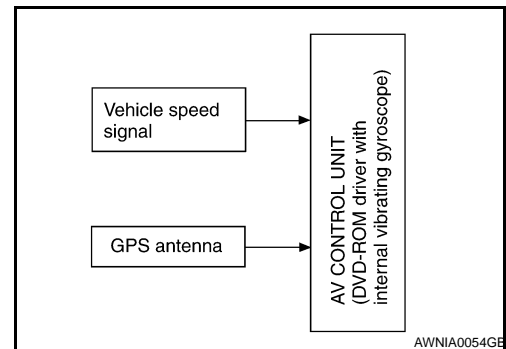

By comparing the vehicle position detection results found by the GPS and by map-matching, more accurate vehicle position data can be used.

The current vehicle position will be calculated by detecting the distance the vehicle moved from the previous calculation point and its direction.

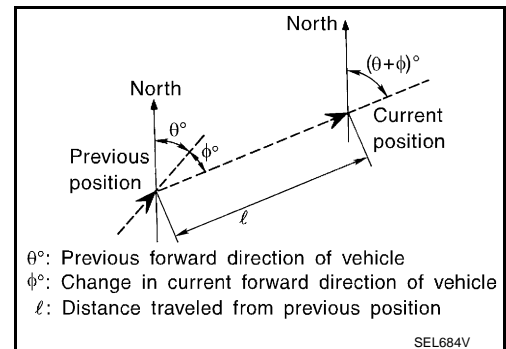

### TRAVEL DISTANCE

Travel distance calculations are based on the vehicle speed input signal. Therefore, the calculation may become incorrect as the tires wear down. To prevent this, an automatic distance fine adjustment function has been adopted.

### TRAVEL DIRECTION

Change in the travel direction of the vehicle is calculated by a gyroscope (angular velocity sensor) and a GPS antenna (GPS information). As the gyroscope and GPS antenna have both merit and demerit, input signals

# NAVIGATION SYSTEM (COUPE)

[BOSE AUDIO WITH NAVIGATION]

## < FUNCTION DIAGNOSIS >

from them are prioritized in each situation. However, this order of priority may change in accordance with more detailed travel conditions so that the travel direction is detected more accurately.

Type	Advantage	Disadvantage
Gyroscope (angular velocity sensor)	<ul style="list-style-type: none"> <li>Can detect the vehicle's turning angle quite accurately.</li> </ul>	<ul style="list-style-type: none"> <li>Direction errors may accumulate when the vehicle is driven for long distances without stopping.</li> </ul>
GPS antenna (GPS information)	<ul style="list-style-type: none"> <li>Can detect the vehicle's travel direction (North/South/East/West).</li> </ul>	<ul style="list-style-type: none"> <li>Correct direction cannot be detected when the vehicle speed is low.</li> </ul>

### MAP-MATCHING

Map-matching is a function that repositions the vehicle on the road map when a new location is judged to be the most accurate. This is done by comparing the current vehicle position, calculated by the method described in the position detection principle, with the road map data around the vehicle, read from the map DVD-ROM stored in the DVD-ROM drive.

Therefore, the vehicle position may not be corrected after the vehicle is driven over a certain distance or time in which GPS information is hard to receive. In this case, the current-location mark on the display must be corrected manually.

#### CAUTION:

**The road map data is based on data stored in the map DVD-ROM.**

- In map-matching, alternative routes to reach the destination will be shown and prioritized, after the road on which the vehicle is currently driven has been judged and the current-location mark has been repositioned.

If there is an error in distance and/or direction, the alternative routes will be shown in different order of priority, and the wrong road can be avoided.

If two roads are running in parallel, they are of the same priority. Therefore, the current-location mark may appear on either of them alternately, depending on maneuvering of the steering wheel and configuration of the road.

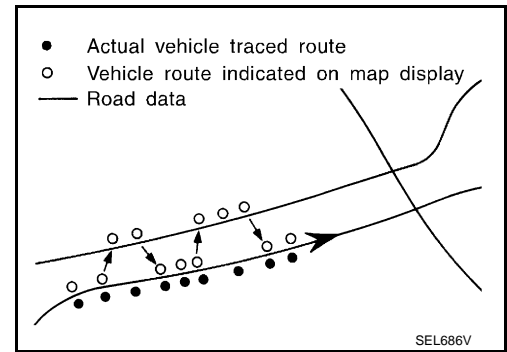
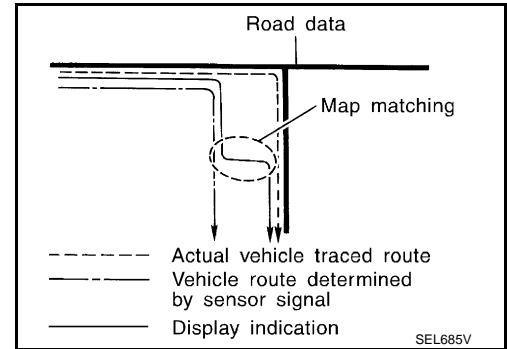

- Map-matching does not function correctly when the road on which the vehicle is driving is new and not recorded in the map DVD-ROM, or when the road pattern stored in the map data and the actual road pattern are different due to repair.

When driving on a road not present in the map, the map-matching function may find another road and position the current-location mark on it. Then, when the correct road is detected, the current-location mark may leap to it.

- Effective range for comparing the vehicle position and travel direction calculated by the distance and direction with the road data read from the map DVD-ROM is limited. Therefore, when there is an excessive gap between the current vehicle position and the position on the map, correction by map-matching is not possible.

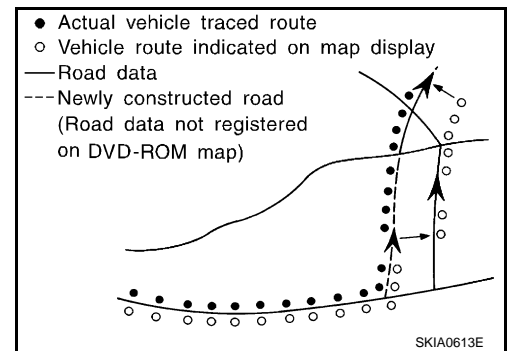

### GPS (GLOBAL POSITIONING SYSTEM)

A  
B  
C  
D  
E  
F  
G  
H  
I  
J  
K  
L  
M  
AV  
O  
P

## NAVIGATION SYSTEM (COUPE)

< FUNCTION DIAGNOSIS >

[BOSE AUDIO WITH NAVIGATION]

GPS (Global Positioning System) has been developed and controlled by the US Department of Defense. The system utilizes GPS satellite (NAVSTAR), sending out radio waves while flying on an orbit around the earth at the height of approx. 21,000 km (13,000 miles). The GPS receiver calculates the vehicle's position in three dimensions (latitude/longitude/altitude) according to the time lag of the radio waves received from four or more GPS satellites (three-dimensional positioning). If radio waves were received only from three GPS satellites, the GPS receiver calculates the vehicle's position in two dimensions (latitude/longitude), utilizing the altitude data calculated previously by using radio waves from four or more GPS satellites (two-dimensional positioning).

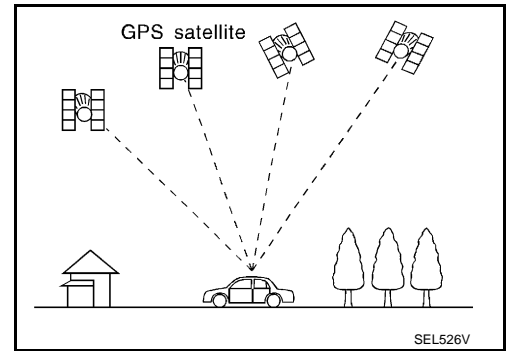

Accuracy of the GPS will deteriorate under the following conditions.

- In two-dimensional positioning, the GPS accuracy will deteriorate when the altitude of the vehicle position changes.
- There may be an error of approximately 10 m (30 ft.) in position detected by three-dimensional positioning, which is more accurate than two-dimensional positioning. The accuracy can be even lower depending on the arrangement of the GPS satellites utilized for the positioning.
- Position detection is not possible when the vehicle is in an area where radio waves from the GPS satellite do not reach, such as in a tunnel, parking lot in a building, and under an elevated highway. Radio waves from the GPS satellites may not be received when some object is located over the GPS antenna.
- Position correction by GPS is not available while the vehicle is stopped.



# NAVIGATION SYSTEM (COUPE)

< FUNCTION DIAGNOSIS >

[BOSE AUDIO WITH NAVIGATION]

## Component Parts Location

INFOID:000000003220896

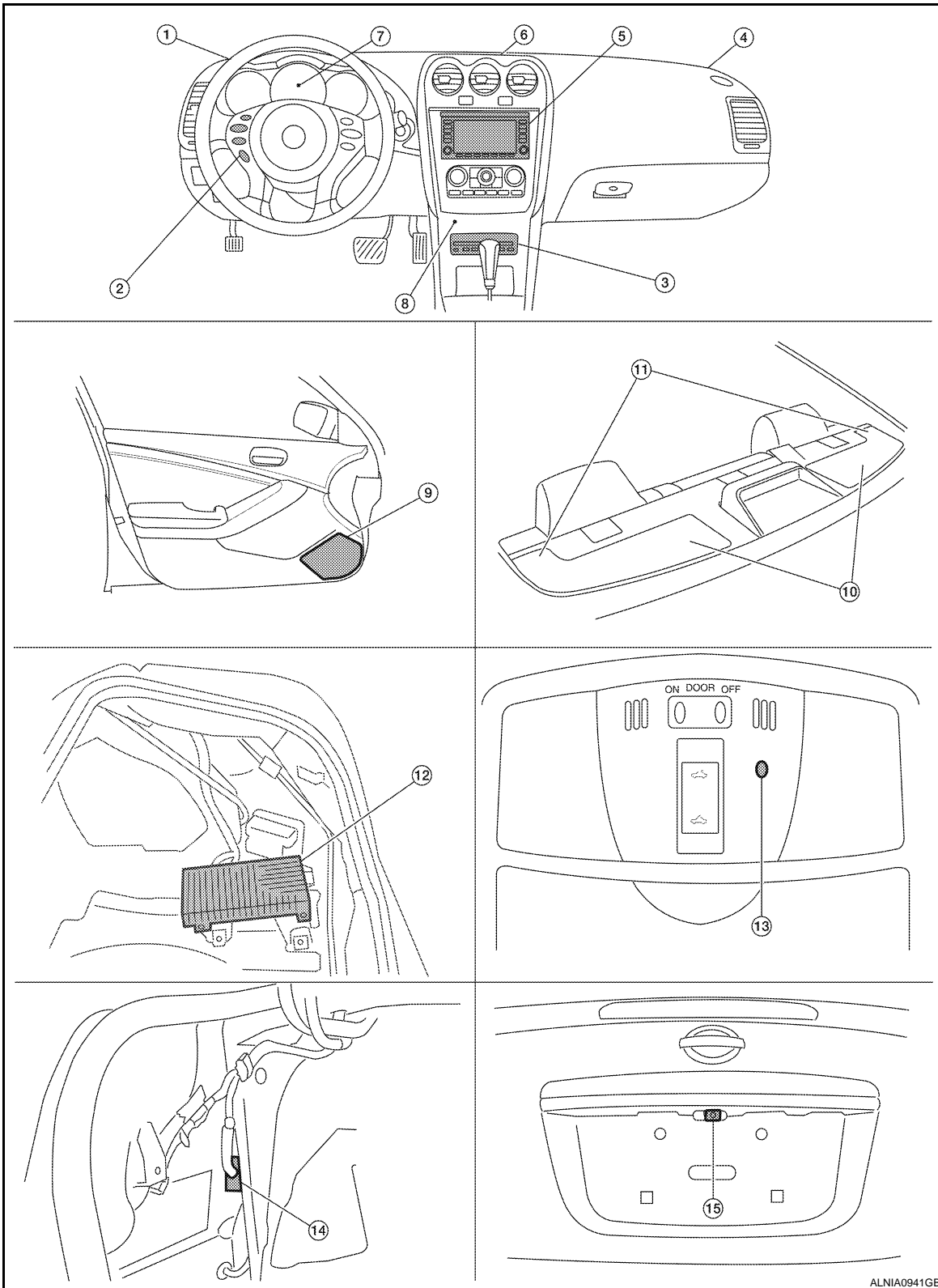

- |                         |   |                        |
|-------------------------|---|------------------------|
| 1. Front tweeter LH M51 | 2. Steering wheel audio control switches        | 3. CD changer M42      |
| 4. Front tweeter RH M52 | 5. AV control unit M46, M47, M48, M81, M90, M91 | 6. Center speaker M151 |

# NAVIGATION SYSTEM (COUPE)

< FUNCTION DIAGNOSIS >

[BOSE AUDIO WITH NAVIGATION]

- |  |  |   |
|--|--|---|
| 7. Combination meter M24               | 8. Aux Jack M41  | 9. Door speaker<br>LH D3<br>RH D103   |
| 10. Rear subwoofer<br>LH B25<br>RH B47 | 11. Rear tweeter<br>LH B16<br>RH B100  | 12. BOSE speaker amp. B121, B122 (view<br>with trunk carpet and RH floor spacer<br>removed) |
| 13. Microphone R7                      | 14. Rear view camera control unit B31<br>(view with trunk side finisher LH re-<br>moved) | 15. Rear view camera T7   |

## Component Description

INFOID:000000001830463

Part name	Description
AV control unit	<ul style="list-style-type: none"><li>Controls each operation of the navigation system</li><li>DVD-ROM drive is built in</li><li>Voice guidance signal is output to BOSE speaker amp.</li></ul>
BOSE speaker amp.	Voice guidance signal is input from AV control unit, and it is output to speakers.
Front tweeter	Voice guidance signal from BOSE speaker amp. is output.
Steering wheel audio control switches	<ul style="list-style-type: none"><li>Each operation of navigation system can be performed</li><li>Switch operating signal is output to AV control unit</li></ul>
Microphone	Sends voice signals to AV control unit
GPS antenna	GPS signal is received and is output to AV control unit.

## NAVIGATION SYSTEM (SEDAN)

### System Diagram

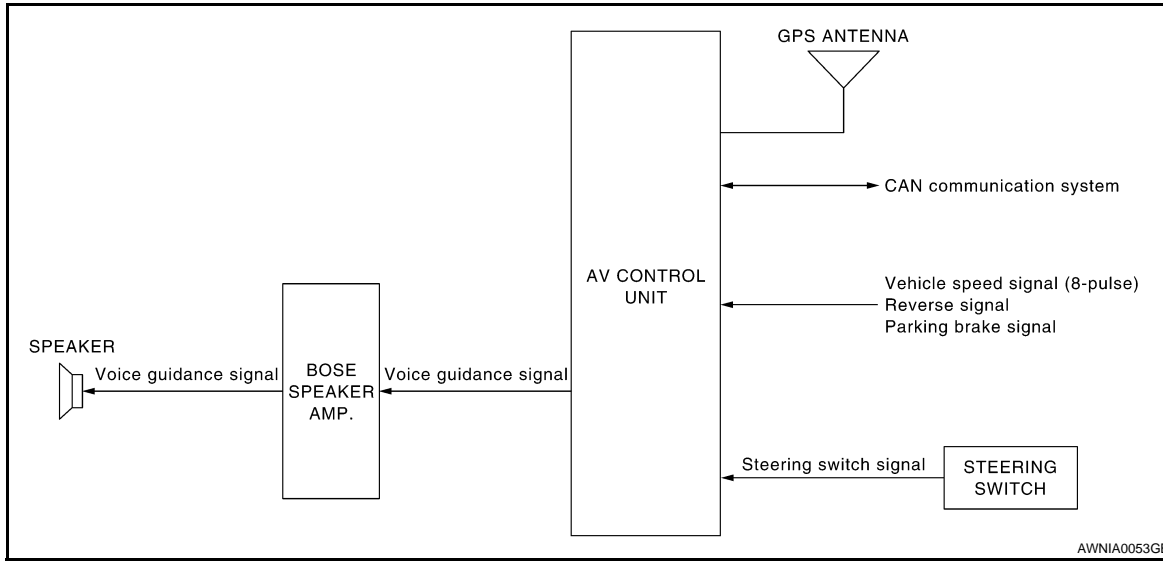

### System Description

INFOID:000000003214780

**NOTE:**

Refer to NAVI System Owner's Manual for system operation.

The navigation system periodically calculates the vehicle's current position according to the following three signals: Travel distance of the vehicle as determined by the vehicle speed sensor, turning angle of the vehicle as determined by the gyroscope (angular velocity sensor), and the direction of vehicle travel as determined by the GPS antenna (GPS information).

The current position of the vehicle is then identified by comparing the calculated vehicle position with map data read from the map DVD-ROM, which is stored in the DVD-ROM drive (map-matching), and indicated on the screen with a current-location mark.

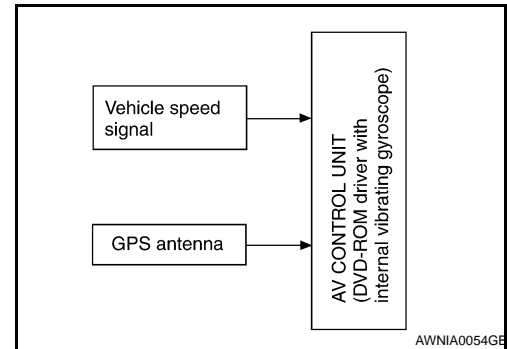

By comparing the vehicle position detection results found by the GPS and by map-matching, more accurate vehicle position data can be used.

The current vehicle position will be calculated by detecting the distance the vehicle moved from the previous calculation point and its direction.

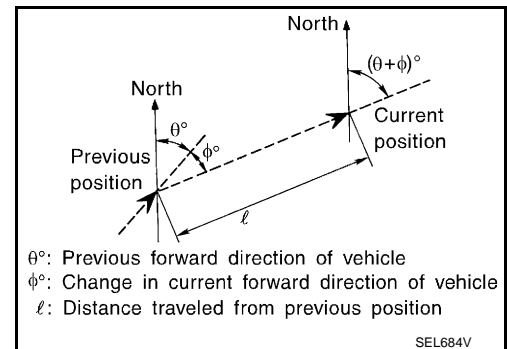

### TRAVEL DISTANCE

Travel distance calculations are based on the vehicle speed input signal. Therefore, the calculation may become incorrect as the tires wear down. To prevent this, an automatic distance fine adjustment function has been adopted.

### TRAVEL DIRECTION

Change in the travel direction of the vehicle is calculated by a gyroscope (angular velocity sensor) and a GPS antenna (GPS information). As the gyroscope and GPS antenna have both merit and demerit, input signals

A  
B  
C  
D  
E  
F  
G  
H  
I  
J  
K  
L  
M  
AV  
O  
P

# NAVIGATION SYSTEM (SEDAN)

[BOSE AUDIO WITH NAVIGATION]

## < FUNCTION DIAGNOSIS >

from them are prioritized in each situation. However, this order of priority may change in accordance with more detailed travel conditions so that the travel direction is detected more accurately.

Type	Advantage	Disadvantage
Gyroscope (angular velocity sensor)	<ul style="list-style-type: none"> <li>Can detect the vehicle's turning angle quite accurately.</li> </ul>	<ul style="list-style-type: none"> <li>Direction errors may accumulate when the vehicle is driven for long distances without stopping.</li> </ul>
GPS antenna (GPS information)	<ul style="list-style-type: none"> <li>Can detect the vehicle's travel direction (North/South/East/West).</li> </ul>	<ul style="list-style-type: none"> <li>Correct direction cannot be detected when the vehicle speed is low.</li> </ul>

### MAP-MATCHING

Map-matching is a function that repositions the vehicle on the road map when a new location is judged to be the most accurate. This is done by comparing the current vehicle position, calculated by the method described in the position detection principle, with the road map data around the vehicle, read from the map DVD-ROM stored in the DVD-ROM drive.

Therefore, the vehicle position may not be corrected after the vehicle is driven over a certain distance or time in which GPS information is hard to receive. In this case, the current-location mark on the display must be corrected manually.

#### CAUTION:

**The road map data is based on data stored in the map DVD-ROM.**

- In map-matching, alternative routes to reach the destination will be shown and prioritized, after the road on which the vehicle is currently driven has been judged and the current-location mark has been repositioned.

If there is an error in distance and/or direction, the alternative routes will be shown in different order of priority, and the wrong road can be avoided.

If two roads are running in parallel, they are of the same priority. Therefore, the current-location mark may appear on either of them alternately, depending on maneuvering of the steering wheel and configuration of the road.

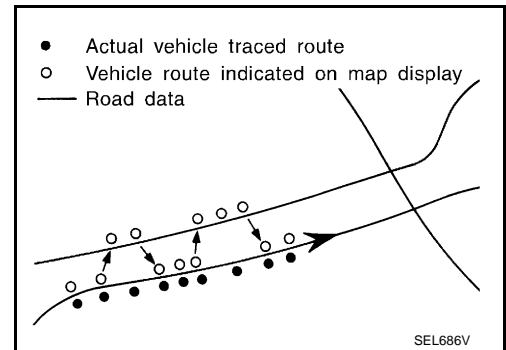
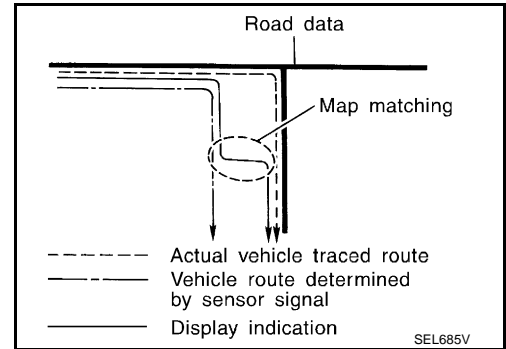

- Map-matching does not function correctly when the road on which the vehicle is driving is new and not recorded in the map DVD-ROM, or when the road pattern stored in the map data and the actual road pattern are different due to repair.

When driving on a road not present in the map, the map-matching function may find another road and position the current-location mark on it. Then, when the correct road is detected, the current-location mark may leap to it.

- Effective range for comparing the vehicle position and travel direction calculated by the distance and direction with the road data read from the map DVD-ROM is limited. Therefore, when there is an excessive gap between the current vehicle position and the position on the map, correction by map-matching is not possible.

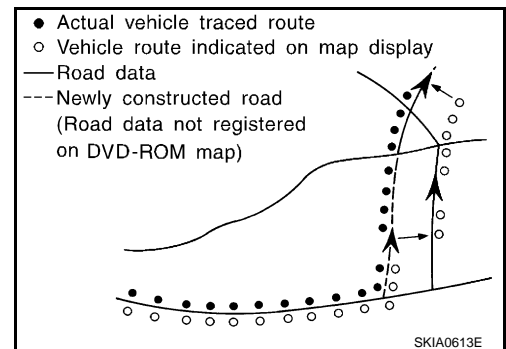

### GPS (GLOBAL POSITIONING SYSTEM)

# NAVIGATION SYSTEM (SEDAN)

[BOSE AUDIO WITH NAVIGATION]

## < FUNCTION DIAGNOSIS >

GPS (Global Positioning System) has been developed and controlled by the US Department of Defense. The system utilizes GPS satellite (NAVSTAR), sending out radio waves while flying on an orbit around the earth at the height of approx. 21,000 km (13,000 miles). The GPS receiver calculates the vehicle's position in three dimensions (latitude/longitude/altitude) according to the time lag of the radio waves received from four or more GPS satellites (three-dimensional positioning). If radio waves were received only from three GPS satellites, the GPS receiver calculates the vehicle's position in two dimensions (latitude/longitude), utilizing the altitude data calculated previously by using radio waves from four or more GPS satellites (two-dimensional positioning).

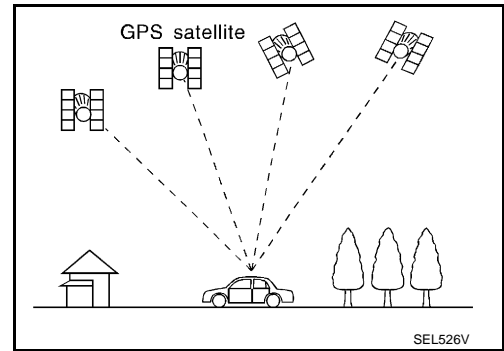

Accuracy of the GPS will deteriorate under the following conditions.

- In two-dimensional positioning, the GPS accuracy will deteriorate when the altitude of the vehicle position changes.
- There may be an error of approximately 10 m (30 ft.) in position detected by three-dimensional positioning, which is more accurate than two-dimensional positioning. The accuracy can be even lower depending on the arrangement of the GPS satellites utilized for the positioning.
- Position detection is not possible when the vehicle is in an area where radio waves from the GPS satellite do not reach, such as in a tunnel, parking lot in a building, and under an elevated highway. Radio waves from the GPS satellites may not be received when some object is located over the GPS antenna.
- Position correction by GPS is not available while the vehicle is stopped.

A  
B  
C  
D  
E  
F  
G  
H  
I  
J  
K  
L  
M  
O  
P

AV

# NAVIGATION SYSTEM (SEDAN)

< FUNCTION DIAGNOSIS >

[BOSE AUDIO WITH NAVIGATION]

---

Component Parts Location

INFOID:000000003220899

# NAVIGATION SYSTEM (SEDAN)

< FUNCTION DIAGNOSIS >

[BOSE AUDIO WITH NAVIGATION]

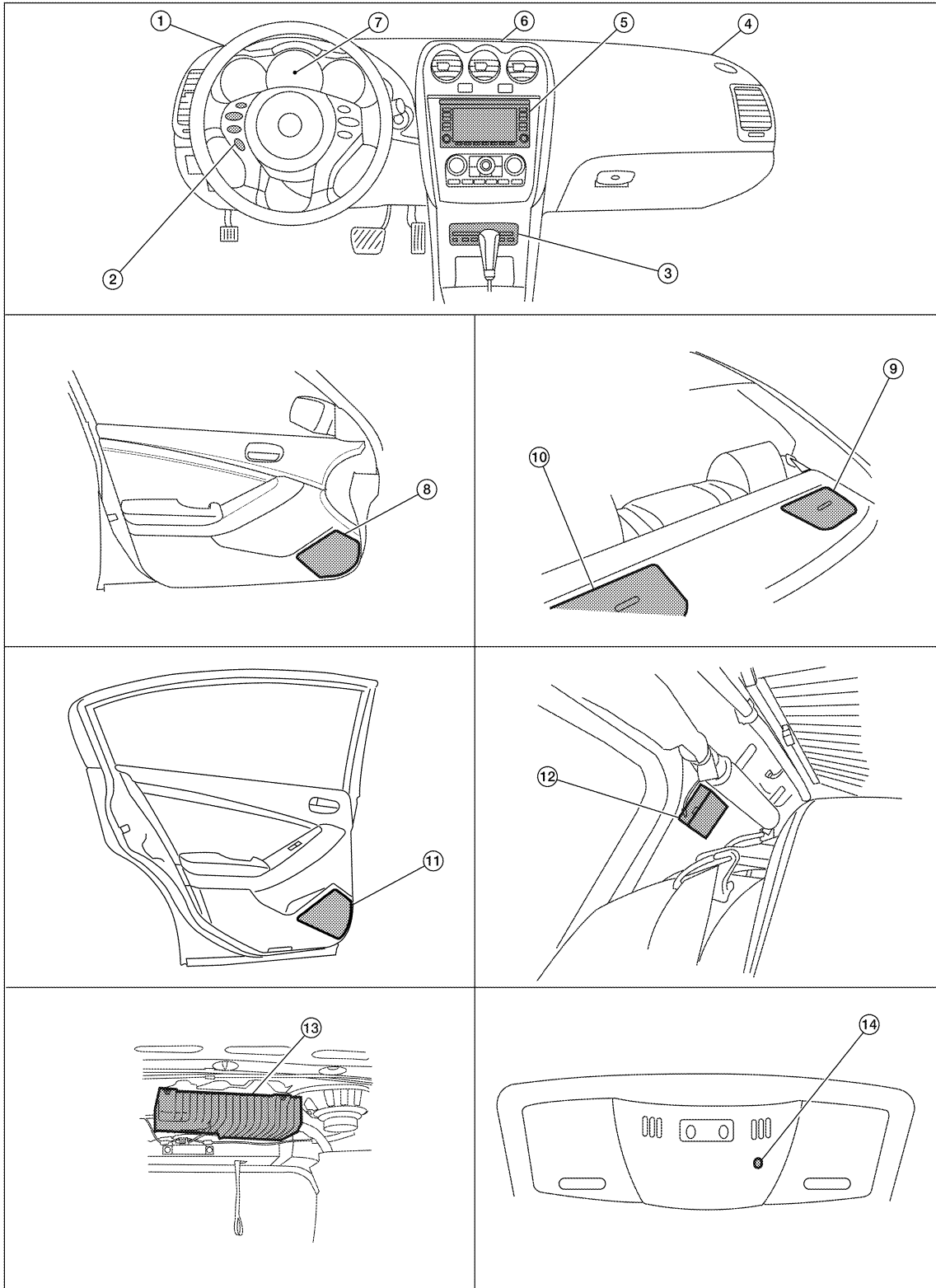

AWN1A0760ZZ

A  
B  
C  
D  
E  
F  
G  
H  
I  
J  
K  
L  
M  
AV  
O  
P

# NAVIGATION SYSTEM (SEDAN)

< FUNCTION DIAGNOSIS >

[BOSE AUDIO WITH NAVIGATION]

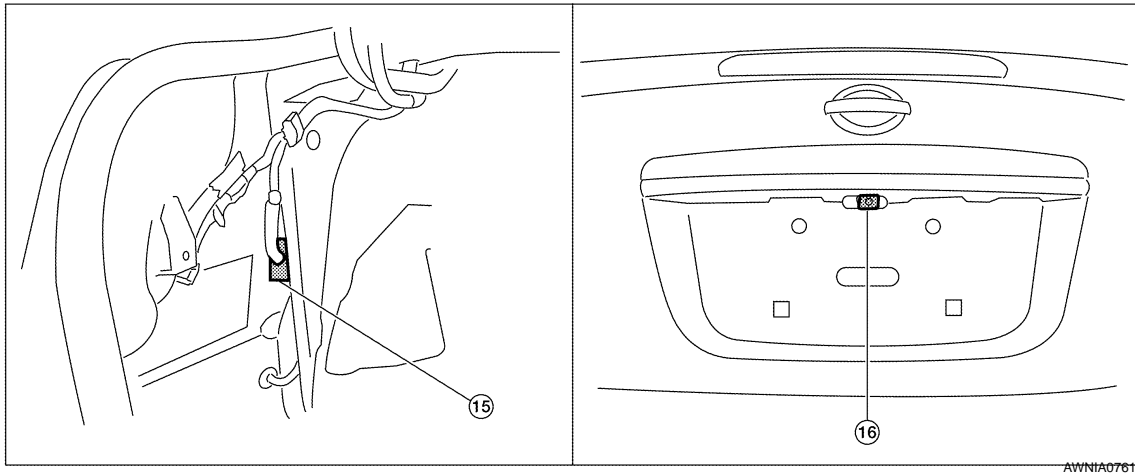

- |                                  |   |  |
|----------------------------------|---|--|
| 1. Tweeter LH M51                | 2. Steering wheel audio control switches        | 3. CD changer M42  |
| 4. Tweeter RH M52                | 5. AV control unit M46, M47, M48, M81, M90, M91 | 6. Center speaker M151   |
| 7. Combination meter M24         | 8. Front door speaker LH D3 RH D103             | 9. Rear subwoofer RH B124  |
| 10. Rear subwoofer LH B120       | 11. Rear door speaker LH D202 RH D302           | 12. Antenna amp M502 (view with rear pillar finisher RH removed)                 |
| 13. BOSE speaker amp. B121, B122 | 14. Microphone R7                               | 15. Rear view camera control unit B31 (view with trunk side finisher LH removed) |
| 16. Rear view camera B35         |   |  |

## Component Description

INFOID:000000003214782

Part name	Description
AV control unit	<ul style="list-style-type: none"> <li>Controls each operation of the navigation system</li> <li>DVD-ROM drive is built in</li> <li>Voice guidance signal is output to BOSE speaker amp.</li> </ul>
BOSE speaker amp.	Voice guidance signal is input from AV control unit, and it is output to speakers.
Tweeter	Voice guidance signal from BOSE speaker amp. is output.
Steering switches	<ul style="list-style-type: none"> <li>Each operation of navigation system can be performed</li> <li>Switch operating signal is output to AV control unit</li> </ul>
Microphone	Sends voice signals to AV control unit
GPS antenna	GPS signal is received and is output to AV control unit.



# REAR VIEW MONITOR SYSTEM (COUPE)

< FUNCTION DIAGNOSIS >

[BOSE AUDIO WITH NAVIGATION]

## REAR VIEW MONITOR SYSTEM (COUPE)

### System Diagram

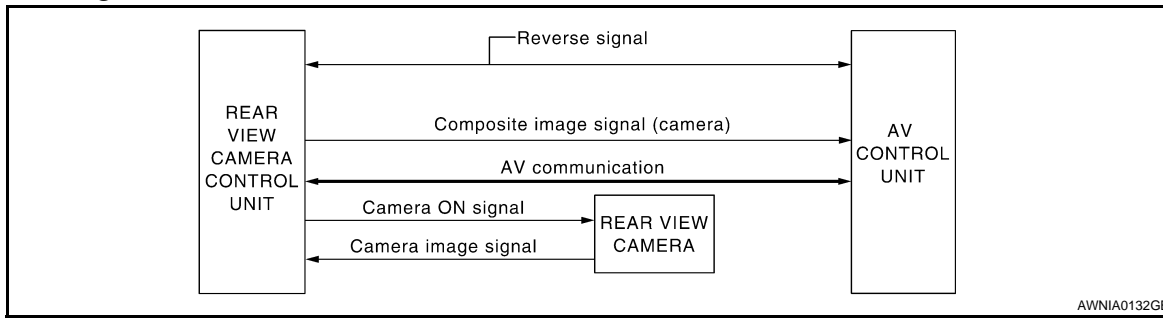

### System Description

INFOID:000000001830465

When the selector is in the R position, the display shows a view to the rear of the vehicle. Lines which indicate the vehicle clearance and distances are also displayed.

#### AV COMMUNICATION LINE

The rear view camera control unit is connected to the AV control unit using an AV communication line. This line is used to transmit and receive data.

A  
B  
C  
D  
E  
F  
G  
H  
I  
J  
K  
L  
M  
O  
P

AV

# REAR VIEW MONITOR SYSTEM (COUPE)

< FUNCTION DIAGNOSIS >

[BOSE AUDIO WITH NAVIGATION]

## Component Parts Location

INFOID:000000003220895

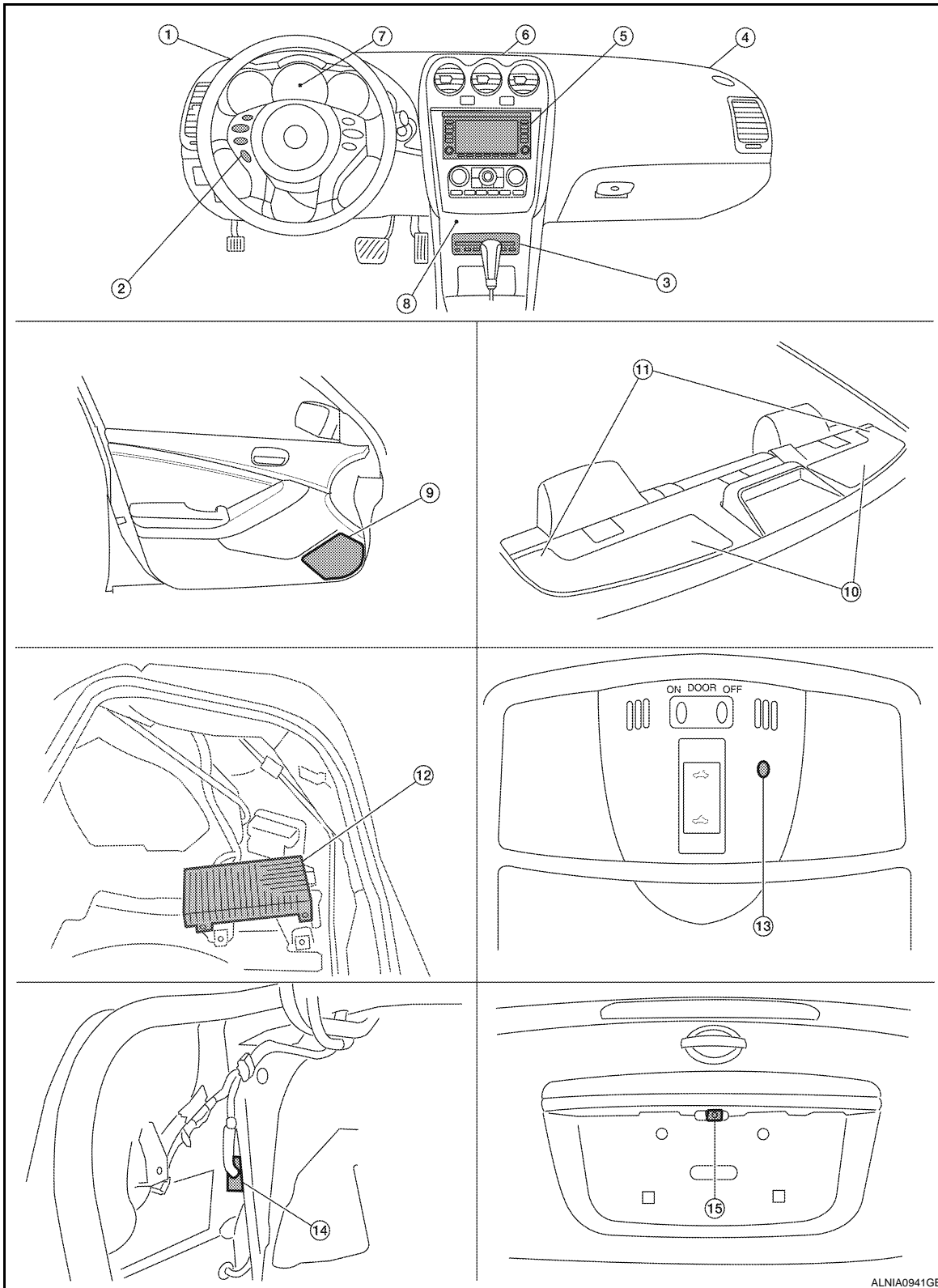

- 1. Front tweeter LH M51
- 4. Front tweeter RH M52

- 2. Steering wheel audio control switches
- 3. CD changer M42
- 5. AV control unit M46, M47, M48, M81, M90, M91
- 6. Center speaker M151

# REAR VIEW MONITOR SYSTEM (COUPE)

< FUNCTION DIAGNOSIS >

[BOSE AUDIO WITH NAVIGATION]

- |  |  |   |
|--|--|---|
| 7. Combination meter M24               | 8. Aux Jack M41  | 9. Door speaker<br>LH D3<br>RH D103   |
| 10. Rear subwoofer<br>LH B25<br>RH B47 | 11. Rear tweeter<br>LH B16<br>RH B100  | 12. BOSE speaker amp. B121, B122 (view<br>with trunk carpet and RH floor spacer<br>removed) |
| 13. Microphone R7                      | 14. Rear view camera control unit B31<br>(view with trunk side finisher LH re-<br>moved) | 15. Rear view camera T7   |

## Component Description

INFOID:000000001830467

Part name	Description
AV control unit	Camera image signal is sent from rear view camera control unit
Rear view camera control unit	<ul style="list-style-type: none"> <li>Receives reverse signal from back-up lamp relay</li> <li>Receives rear view camera image signal</li> <li>Sends camera ON signal to rear view camera</li> <li>Sends image signal to AV control unit</li> </ul>
Rear view camera	<ul style="list-style-type: none"> <li>Receives camera ON signal from rear view camera control unit</li> <li>Sends image signal to rear view camera control unit</li> </ul>

AV

# REAR VIEW MONITOR SYSTEM (SEDAN)

< FUNCTION DIAGNOSIS >

[BOSE AUDIO WITH NAVIGATION]

## REAR VIEW MONITOR SYSTEM (SEDAN)

### System Diagram

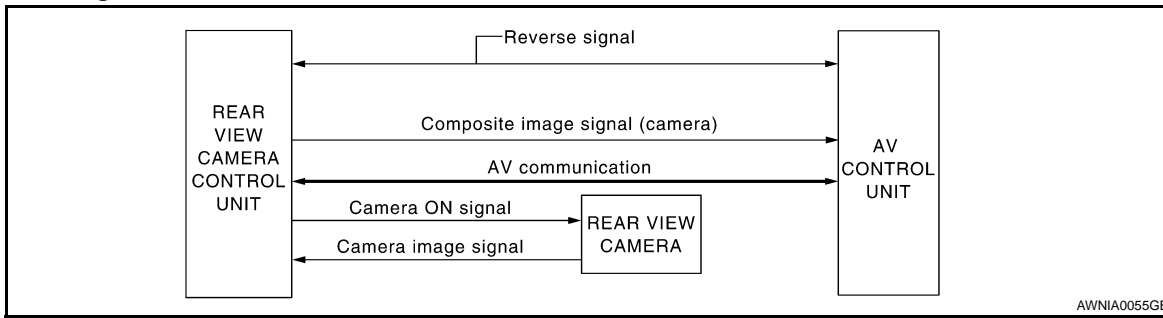

### System Description

INFOID:000000003214784

When the selector is in the R position, the display will show a view to the rear of the vehicle. Lines which indicate the vehicle clearance and distances are also displayed.

#### AV COMMUNICATION LINE

The rear view camera control unit is connected to the AV control unit using an AV communication line. This line is used to transmit and receive data.

# REAR VIEW MONITOR SYSTEM (SEDAN)

< FUNCTION DIAGNOSIS >

[BOSE AUDIO WITH NAVIGATION]

## Component Parts Location

INFOID:000000003220900

A

B

C

D

E

F

G

H

I

J

K

L

M

**AV**

O

P

# REAR VIEW MONITOR SYSTEM (SEDAN)

< FUNCTION DIAGNOSIS >

[BOSE AUDIO WITH NAVIGATION]

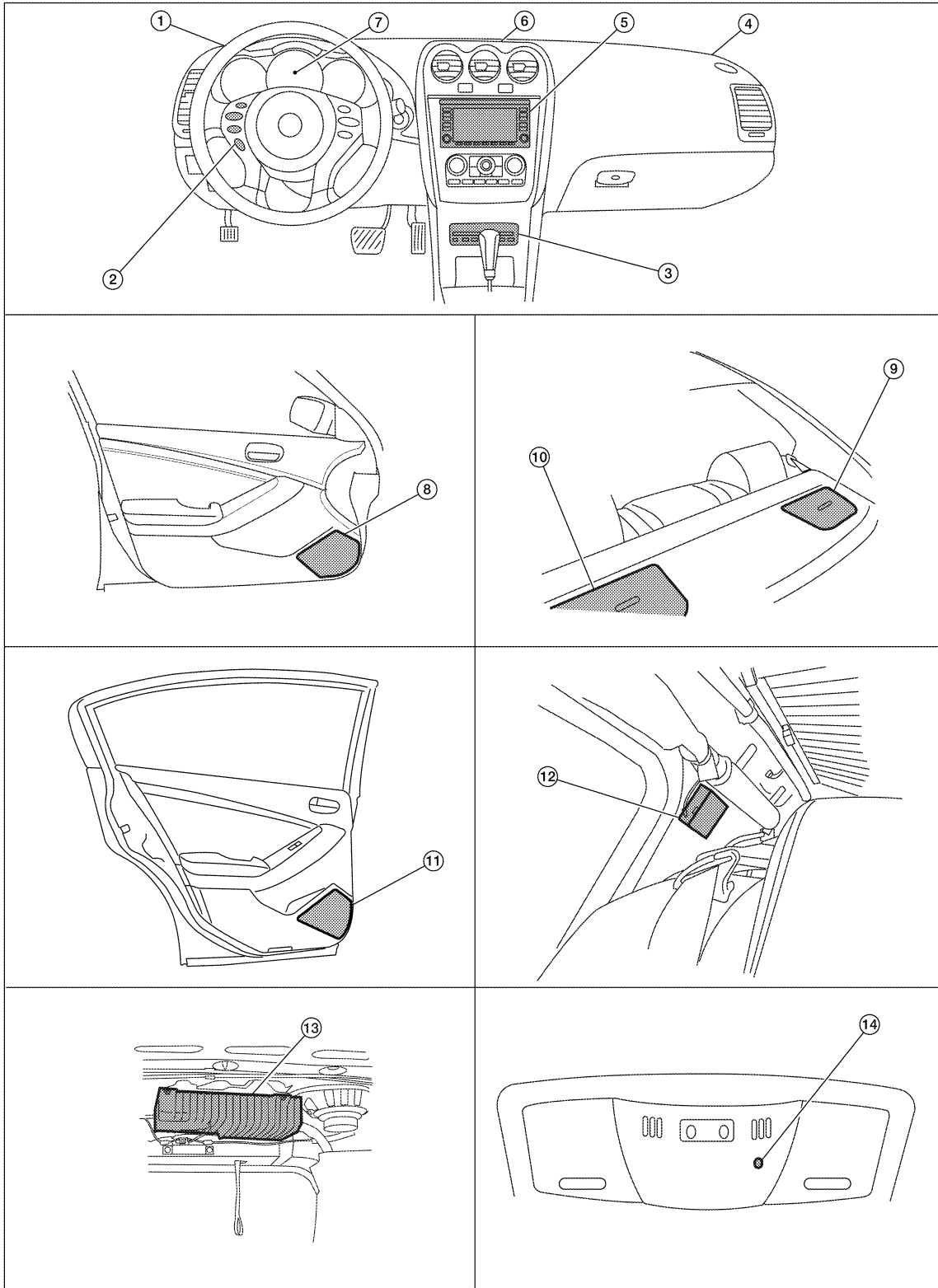

AWNIA0760ZZ

# REAR VIEW MONITOR SYSTEM (SEDAN)

< FUNCTION DIAGNOSIS >

[BOSE AUDIO WITH NAVIGATION]

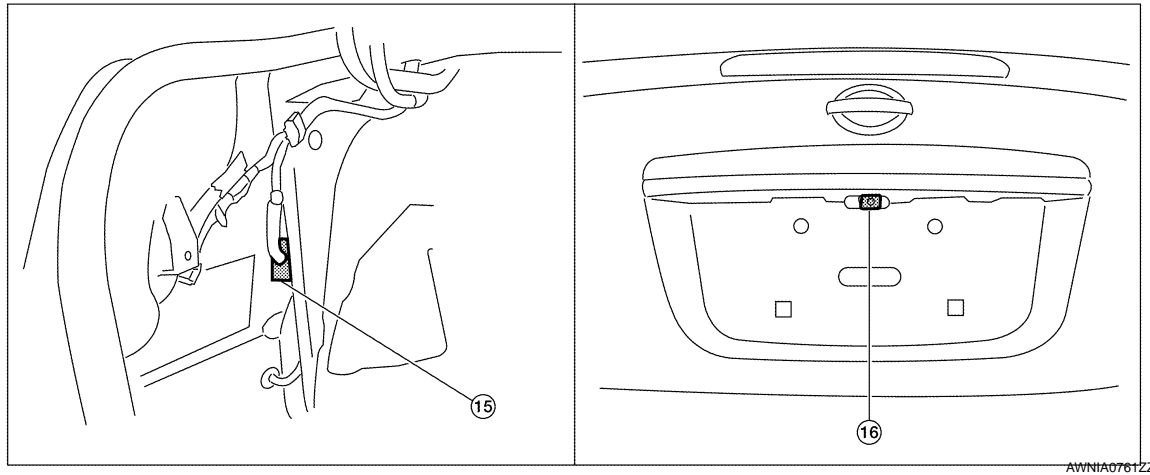

- |                                  |   |  |
|----------------------------------|---|--|
| 1. Tweeter LH M51                | 2. Steering wheel audio control switches        | 3. CD changer M42  |
| 4. Tweeter RH M52                | 5. AV control unit M46, M47, M48, M81, M90, M91 | 6. Center speaker M151   |
| 7. Combination meter M24         | 8. Front door speaker LH D3 RH D103             | 9. Rear subwoofer RH B124  |
| 10. Rear subwoofer LH B120       | 11. Rear door speaker LH D202 RH D302           | 12. Antenna amp M502 (view with rear pillar finisher RH removed)                 |
| 13. BOSE speaker amp. B121, B122 | 14. Microphone R7                               | 15. Rear view camera control unit B31 (view with trunk side finisher LH removed) |
| 16. Rear view camera B35         |   |  |

## Component Description

INFOID:000000003214786

Part name	Description
AV control unit	Camera image signal is sent from rear view camera control unit
Rear view camera control unit	<ul style="list-style-type: none"> <li>Receives reverse signal from park/neutral position (PNP) switch (with CVT and QR25DE)</li> <li>Receives reverse signal from back-up lamp relay (with CVT and VQ35DE)</li> <li>Receives reverse signal from back up lamp switch (with M/T)</li> <li>Receives rear view camera image signal</li> <li>Sends camera ON signal to rear view camera</li> <li>Sends image signal to AV control unit</li> </ul>
Rear view camera	<ul style="list-style-type: none"> <li>Receives camera ON signal from rear view camera control unit</li> <li>Sends image signal to rear view camera control unit</li> </ul>

AV

## AUDIO SYSTEM (COUPE)

### System Diagram

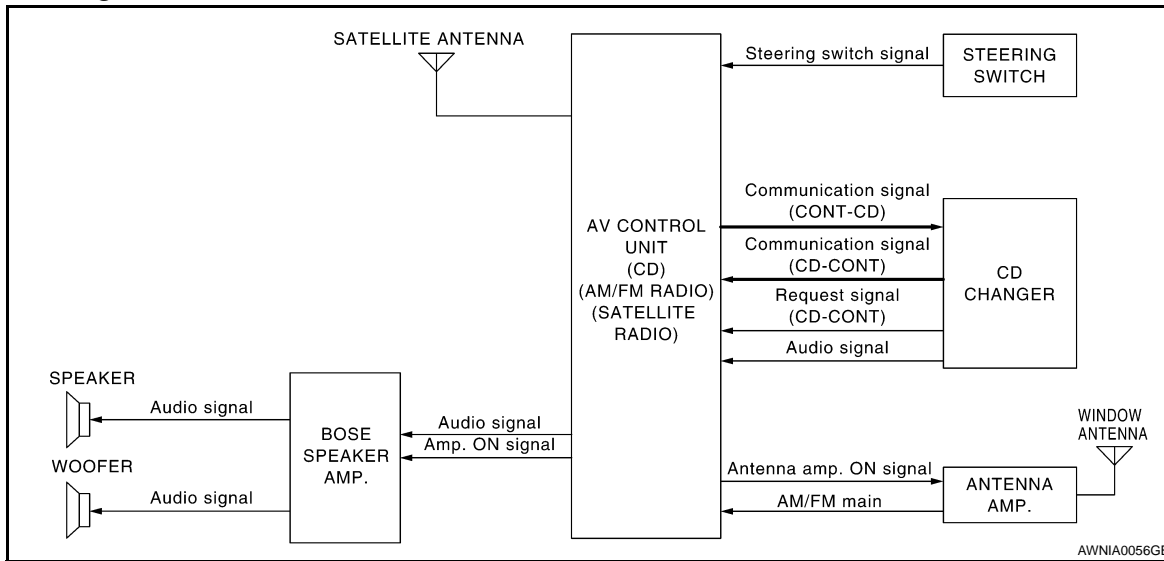

### System Description

INFOID:000000001830469

#### AUDIO SYSTEM

The audio system consists of the following components

- AV control unit (audio unit)
- BOSE speaker amp.
- Window antenna
- Steering wheel audio control switches
- Door speakers
- Front tweeters
- Center speaker
- Rear tweeters
- Subwoofers
- CD changer

When the audio system is on, radio signals are received by the window antenna. The audio unit then sends audio signals to the BOSE speaker amp. The BOSE speaker amp. amplifies the audio signals before sending them to the door speakers, front tweeters, center speaker, rear tweeters and subwoofers.

Refer to Owner's Manual for audio system operating instructions.

#### SATELLITE RADIO SYSTEM

The satellite radio system consists of the following components

- Roof antenna (satellite)
- Satellite radio tuner

When the satellite radio system is on, radio signals are supplied to the satellite radio tuner from the satellite antenna. The satellite radio tuner then sends audio signals to the audio unit.

Refer to Owner's Manual for satellite radio system operating instructions.

#### SPEED SENSITIVE VOLUME SYSTEM

Volume level of this system goes up and down automatically in proportion to the vehicle speed. The control level can be selected by the customer. Refer to Owner's Manual for operating instructions.



# AUDIO SYSTEM (COUPE)

< FUNCTION DIAGNOSIS >

[BOSE AUDIO WITH NAVIGATION]

## Component Parts Location

INFOID:000000003220892

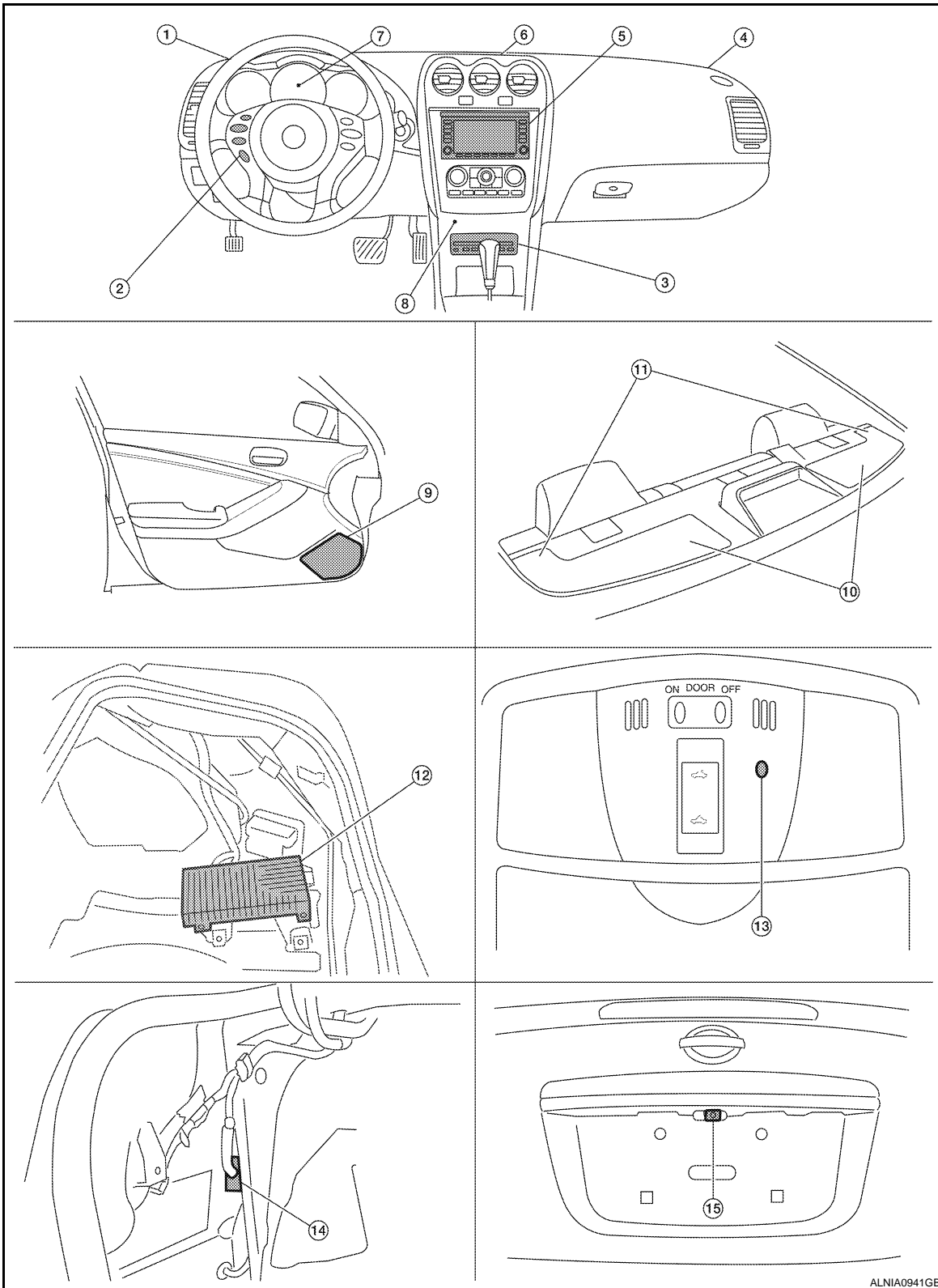

- |                         |   |                        |
|-------------------------|---|------------------------|
| 1. Front tweeter LH M51 | 2. Steering wheel audio control switches        | 3. CD changer M42      |
| 4. Front tweeter RH M52 | 5. AV control unit M46, M47, M48, M81, M90, M91 | 6. Center speaker M151 |

## AUDIO SYSTEM (COUPE)

< FUNCTION DIAGNOSIS >

[BOSE AUDIO WITH NAVIGATION]

- |  |   |   |
|--|---|---|
| 7. Combination meter M24               | 8. Aux Jack M41   | 9. Door speaker<br>LH D3<br>RH D103   |
| 10. Rear subwoofer<br>LH B25<br>RH B47 | 11. Rear tweeter<br>LH B16<br>RH B100   | 12. BOSE speaker amp. B121, B122 (view with trunk carpet and RH floor spacer removed) |
| 13. Microphone R7                      | 14. Rear view camera control unit B31<br>(view with trunk side finisher LH removed) | 15. Rear view camera T7   |

### Component Description

INFOID:000000001830471

Part name	Description
AV control unit	<ul style="list-style-type: none"> <li>• Controls audio system and satellite radio system functions</li> <li>• Audio information is displayed on display screen</li> </ul>
BOSE speaker amp.	Receives power (amp ON) and audio signals from AV control unit, and outputs audio signals to each speaker.
CD changer	Sends audio signals to AV control unit
Door speaker	<ul style="list-style-type: none"> <li>• Outputs audio signal from BOSE speaker amp.</li> <li>• Outputs high, mid and low range sounds</li> </ul>
Front tweeter	<ul style="list-style-type: none"> <li>• Outputs audio signal from BOSE speaker amp.</li> <li>• Outputs high range sound</li> </ul>
Center speaker	<ul style="list-style-type: none"> <li>• Outputs audio signal from BOSE speaker amp.</li> <li>• Outputs high, mid and low range sounds</li> </ul>
Rear tweeter	<ul style="list-style-type: none"> <li>• Outputs audio signal from BOSE speaker amp.</li> <li>• Outputs high range sounds</li> </ul>
Subwoofer	<ul style="list-style-type: none"> <li>• Outputs audio signal from BOSE speaker amp.</li> <li>• Outputs low range sound</li> </ul>
Steering wheel audio control switches	<ul style="list-style-type: none"> <li>• Each audio operation can be operated</li> <li>• Steering switch signal (operation signal) is output to AV control unit</li> </ul>
Satellite antenna	Audio signal (satellite radio) is received and output to AV control unit.

# AUDIO SYSTEM (SEDAN)

< FUNCTION DIAGNOSIS >

[BOSE AUDIO WITH NAVIGATION]

## AUDIO SYSTEM (SEDAN)

### System Diagram

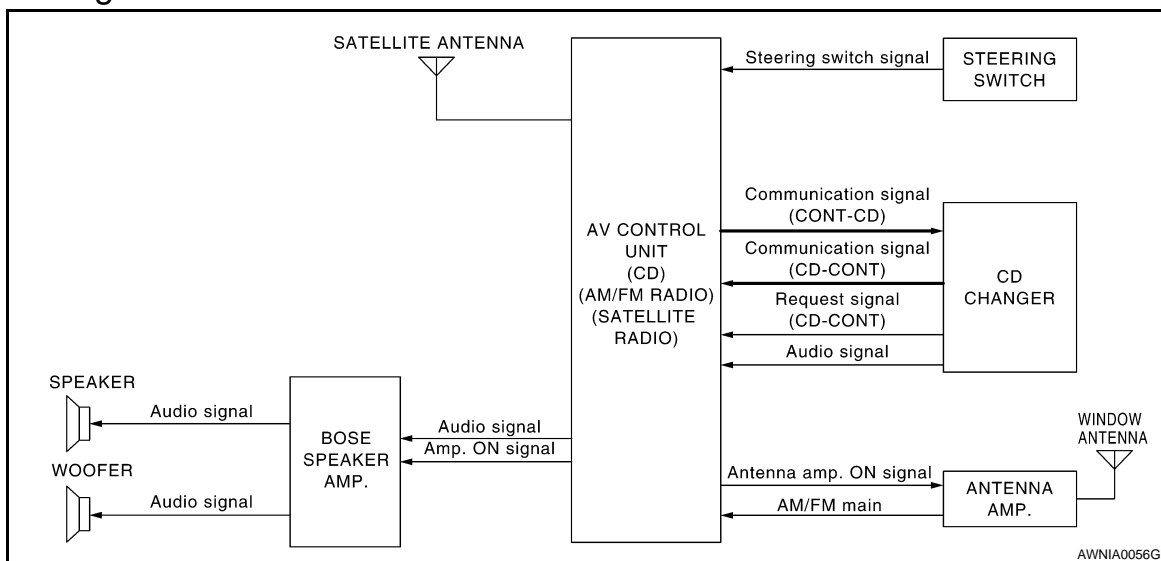

### System Description

#### AUDIO SYSTEM

The audio system consists of the following components

- AV control unit (audio unit)
- BOSE speaker amp.
- Window antenna
- Antenna amp.
- Steering wheel audio control switches
- Front door speakers
- Tweeters
- Center speaker
- Rear door speakers
- Subwoofers
- CD changer

When the audio system is on, radio signals are received by the window antenna. These signals are amplified by the antenna amp. before reaching the audio unit. The audio unit then sends audio signals to the BOSE speaker amp. The BOSE speaker amp. amplifies the audio signals before sending them to the front door speakers, tweeters, center speaker, rear door speakers and subwoofers.

Refer to Owner's Manual for audio system operating instructions.

#### SATELLITE RADIO SYSTEM

The satellite radio system consists of the following components

- Satellite antenna
- Satellite radio tuner

When the satellite radio system is on, radio signals are supplied to the satellite radio tuner from the satellite antenna. The satellite radio tuner then sends audio signals to the audio unit.

Refer to Owner's Manual for satellite radio system operating instructions.

#### SPEED SENSITIVE VOLUME SYSTEM

Volume level of this system goes up and down automatically in proportion to the vehicle speed. The control level can be selected by the customer. Refer to Owner's Manual for operating instructions.

A  
B  
C  
D  
E  
F  
G  
H  
I  
J  
K  
L  
M  
AV  
O  
P

# AUDIO SYSTEM (SEDAN)

< FUNCTION DIAGNOSIS >

[BOSE AUDIO WITH NAVIGATION]

---

Component Parts Location

INFOID:000000003220901

# AUDIO SYSTEM (SEDAN)

< FUNCTION DIAGNOSIS >

[BOSE AUDIO WITH NAVIGATION]

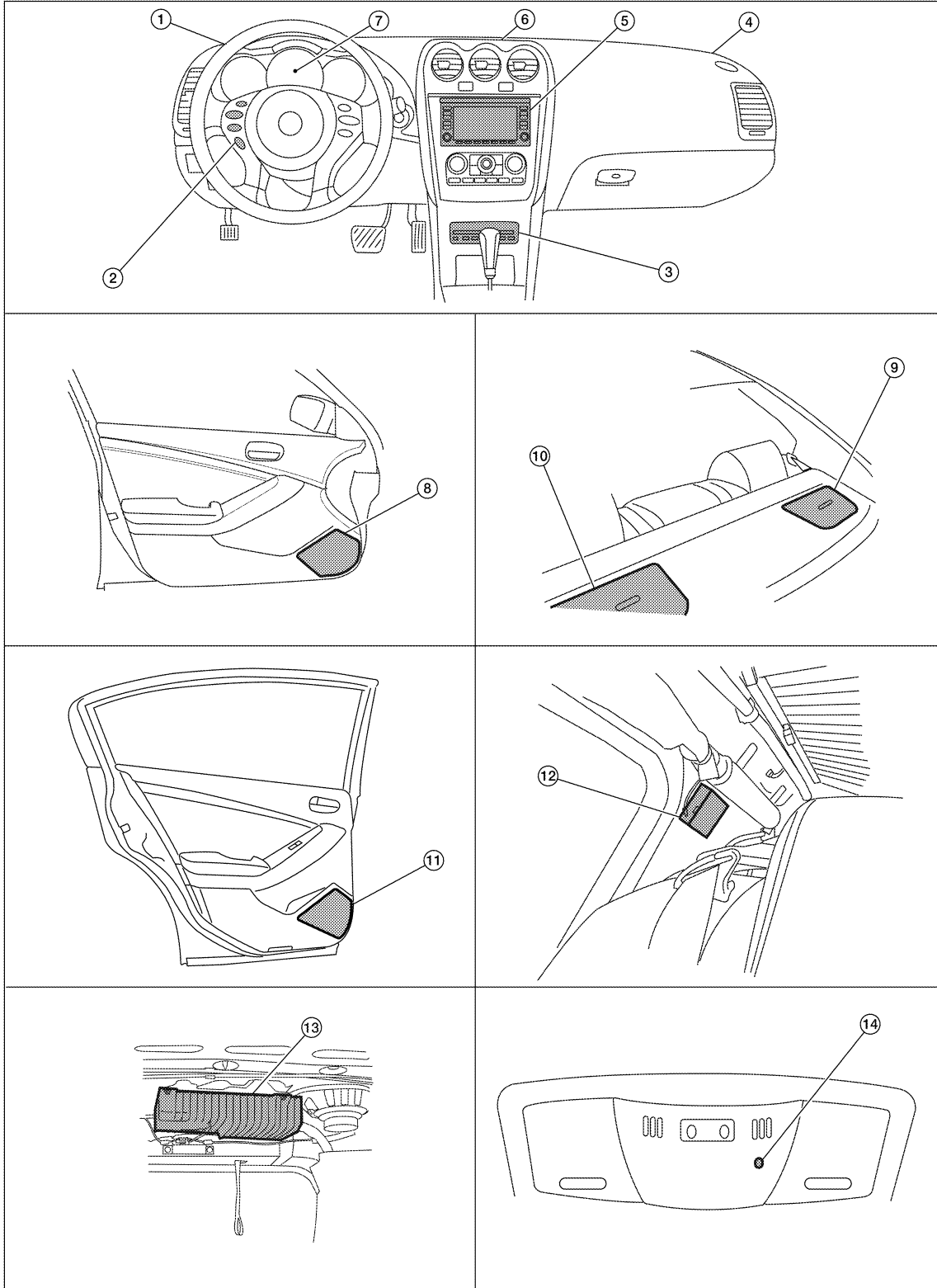

AWN1A0760ZZ

A  
B  
C  
D  
E  
F  
G  
H  
I  
J  
K  
L  
M  
AV  
O  
P

# AUDIO SYSTEM (SEDAN)

< FUNCTION DIAGNOSIS >

[BOSE AUDIO WITH NAVIGATION]

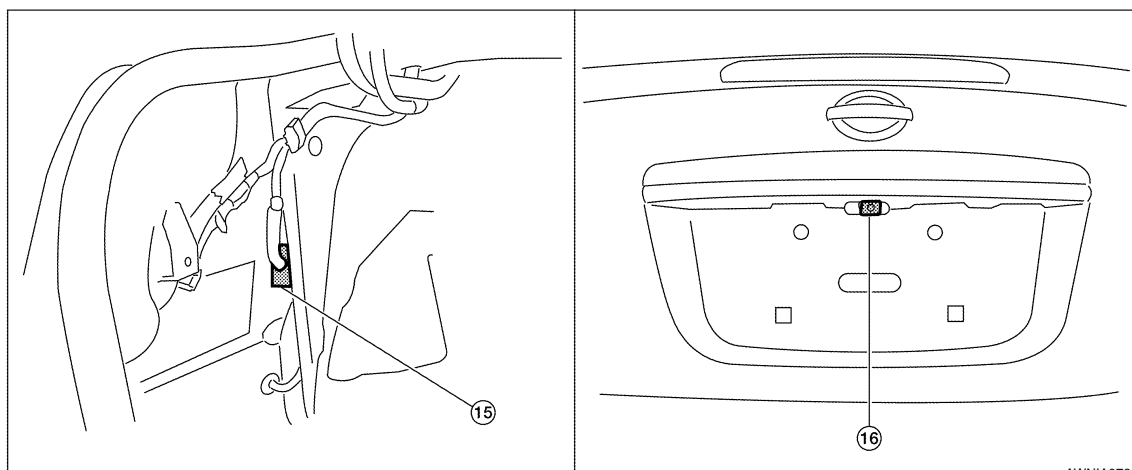

- |                                  |   |  |
|----------------------------------|---|--|
| 1. Tweeter LH M51                | 2. Steering wheel audio control switches        | 3. CD changer M42  |
| 4. Tweeter RH M52                | 5. AV control unit M46, M47, M48, M81, M90, M91 | 6. Center speaker M151   |
| 7. Combination meter M24         | 8. Front door speaker LH D3<br>RH D103          | 9. Rear subwoofer RH B124  |
| 10. Rear subwoofer LH B120       | 11. Rear door speaker LH D202<br>RH D302        | 12. Antenna amp M502 (view with rear pillar finisher RH removed)                 |
| 13. BOSE speaker amp. B121, B122 | 14. Microphone R7                               | 15. Rear view camera control unit B31 (view with trunk side finisher LH removed) |
| 16. Rear view camera B35         |   |  |

## Component Description

INFOID:000000003214790

Part name	Description
AV control unit	<ul style="list-style-type: none"> <li>Controls audio system and satellite radio system functions</li> <li>Audio information is displayed on display screen</li> </ul>
BOSE speaker amp.	Receives power (amp ON) and audio signals from AV control unit, and outputs audio signals to each speaker.
CD changer	Sends audio signals to AV control unit
Front door speaker	<ul style="list-style-type: none"> <li>Outputs audio signal from BOSE speaker amp.</li> <li>Outputs high, mid and low range sounds</li> </ul>
Tweeter	<ul style="list-style-type: none"> <li>Outputs audio signal from BOSE speaker amp.</li> <li>Outputs high range sound</li> </ul>
Center speaker	<ul style="list-style-type: none"> <li>Outputs audio signal from BOSE speaker amp.</li> <li>Outputs high, mid and low range sounds</li> </ul>
Rear door speaker	<ul style="list-style-type: none"> <li>Outputs audio signal from BOSE speaker amp.</li> <li>Outputs high, mid and low range sounds</li> </ul>
Subwoofer	<ul style="list-style-type: none"> <li>Outputs audio signal from BOSE speaker amp.</li> <li>Outputs low range sound</li> </ul>
Steering wheel audio control switches	<ul style="list-style-type: none"> <li>Each audio operation can be operated</li> <li>Steering switch signal (operation signal) is output to AV control unit</li> </ul>
Antenna amp.	<ul style="list-style-type: none"> <li>Radio signal received by window antenna is amplified and sent to AV control unit</li> <li>Power (antenna amp ON signal) is supplied from AV control unit</li> </ul>
Satellite antenna	Audio signal (satellite radio) is received and output to AV control unit.

# HANDS FREE PHONE SYSTEM (COUPE)

< FUNCTION DIAGNOSIS >

[BOSE AUDIO WITH NAVIGATION]

## HANDS FREE PHONE SYSTEM (COUPE)

### System Diagram

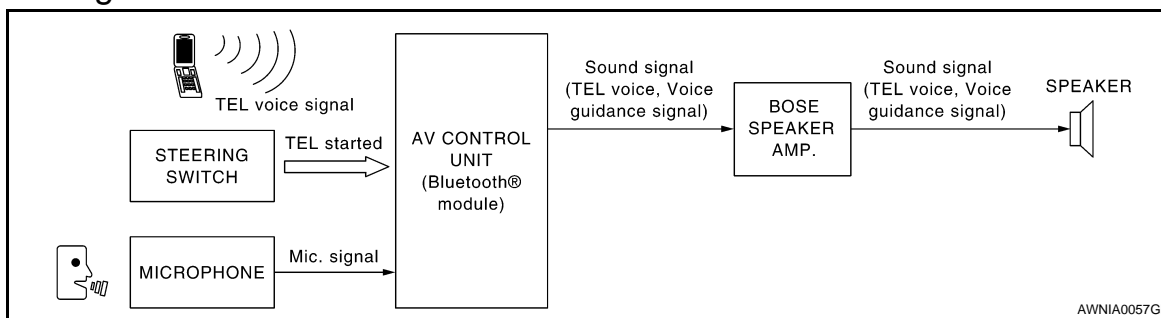

### System Description

INFOID:000000001830473

Refer to the owner's manual for Bluetooth telephone system operating instructions.

#### NOTE:

Cellular telephones must have their wireless connection set up (paired) before using the Bluetooth telephone system.

Bluetooth telephone system allows users who have a Bluetooth cellular telephone to make a wireless connection between their cellular telephone and the AV control unit. Hands-free cellular telephone calls can be sent and received. Some Bluetooth cellular telephones may not be recognized by the AV control unit. When a cellular telephone or the AV control unit is replaced, the telephone must be paired with the AV control unit. Different cellular telephones may have different pairing procedures. Refer to the cellular telephone operating manual.

#### AV CONTROL UNIT

When the ignition switch is turned to ACC or ON, the AV control unit will power up. During power up, the AV control unit is initialized and performs various self checks. Initialization may take up to 10 seconds. If a phone is present in the vehicle and paired with the AV control unit, Nissan Voice Recognition will then become active. Bluetooth telephone functions can be turned off using the Nissan Voice Recognition system.

#### STEERING WHEEL AUDIO CONTROL SWITCHES

When buttons on the steering wheel audio control switch are pushed, the resistance in steering wheel audio control switch circuit changes depending on which button is pushed. The AV control unit uses this signal to perform various functions while navigating through the voice recognition system.

The following functions can be performed using the steering wheel audio control switch:

- Initiate Self-Diagnosis of the Bluetooth telephone system
- Start a voice recognition session
- Answer and end telephone calls
- Adjust the volume of calls

#### MICROPHONE

The microphone is located in the roof console assembly. The microphone sends a signal to the AV control unit. The microphone can be actively tested during self-diagnosis.

A

B

C

D

E

F

G

H

I

J

K

L

M

AV

O

P

# HANDS FREE PHONE SYSTEM (COUPE)

< FUNCTION DIAGNOSIS >

[BOSE AUDIO WITH NAVIGATION]

## Component Parts Location

INFOID:000000003220894

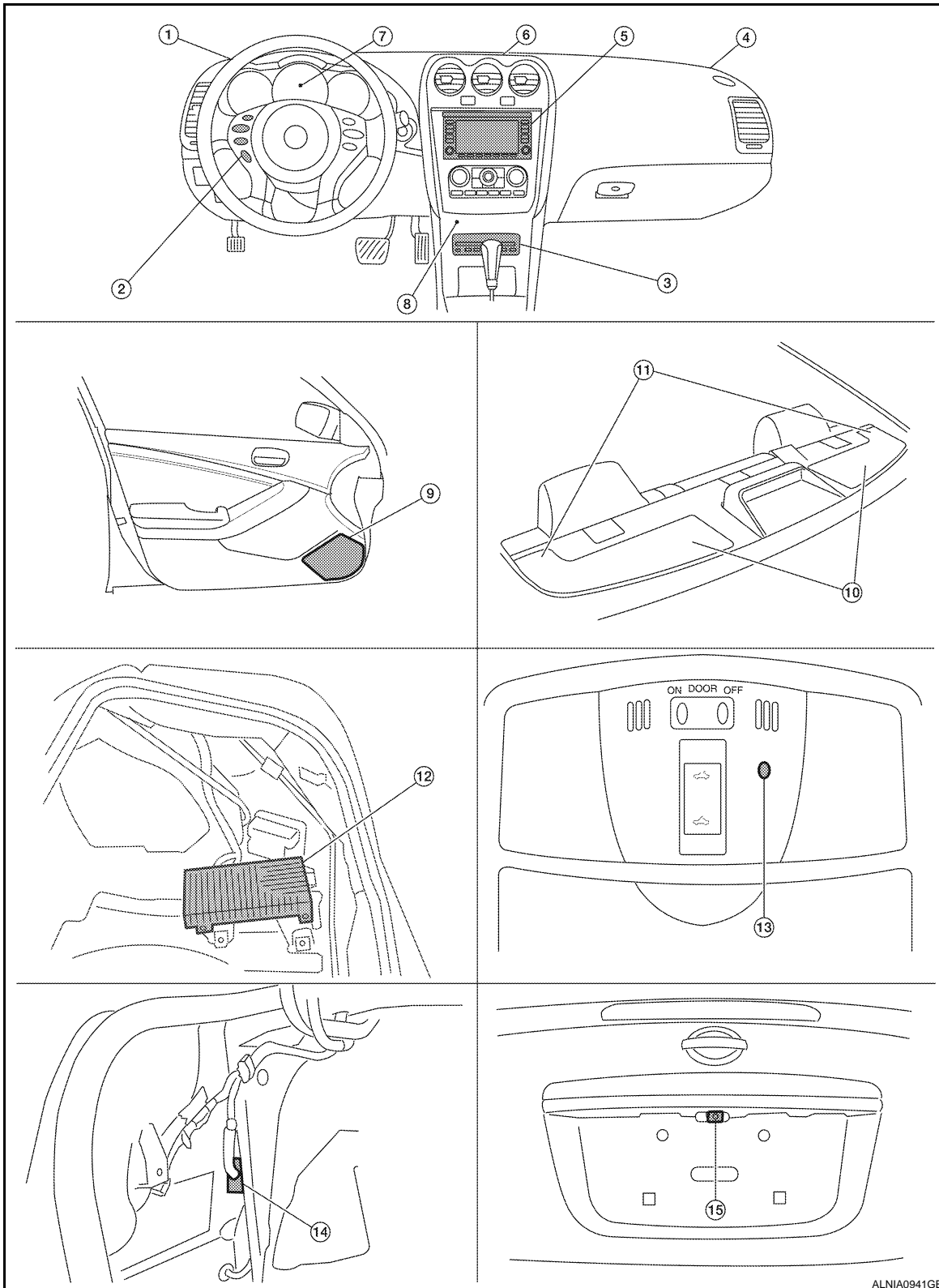

ALNIA0941GB

- |                         |   |                        |
|-------------------------|---|------------------------|
| 1. Front tweeter LH M51 | 2. Steering wheel audio control switches        | 3. CD changer M42      |
| 4. Front tweeter RH M52 | 5. AV control unit M46, M47, M48, M81, M90, M91 | 6. Center speaker M151 |



# HANDS FREE PHONE SYSTEM (COUPE)

< FUNCTION DIAGNOSIS >

[BOSE AUDIO WITH NAVIGATION]

- |  |  |   |
|--|--|---|
| 7. Combination meter M24               | 8. Aux Jack M41  | 9. Door speaker<br>LH D3<br>RH D103   |
| 10. Rear subwoofer<br>LH B25<br>RH B47 | 11. Rear tweeter<br>LH B16<br>RH B100  | 12. BOSE speaker amp. B121, B122 (view<br>with trunk carpet and RH floor spacer<br>removed) |
| 13. Microphone R7                      | 14. Rear view camera control unit B31<br>(view with trunk side finisher LH re-<br>moved) | 15. Rear view camera T7   |

## Component Description

INFOID:000000001830475

Part name	Description
AV control unit	<ul style="list-style-type: none"> <li>Controls hands-free phone functions</li> <li>Displays hands-free phone information on display screen</li> </ul>
BOSE speaker amp.	Inputs power (amp ON) and sound signal from AV control unit, and outputs sound signal to each speaker.
Door speaker	Receives telephone voice and voice guidance signals from the BOSE speaker amp.
Front tweeter	
Center speaker	
Steering wheel audio control switches	<ul style="list-style-type: none"> <li>Start a voice recognition session</li> <li>Answer and end telephone calls</li> <li>Adjust the volume level</li> </ul>
Microphone	Sends voice signals to AV control unit

AV

# HANDS FREE PHONE SYSTEM (SEDAN)

< FUNCTION DIAGNOSIS >

[BOSE AUDIO WITH NAVIGATION]

## HANDS FREE PHONE SYSTEM (SEDAN)

### System Diagram

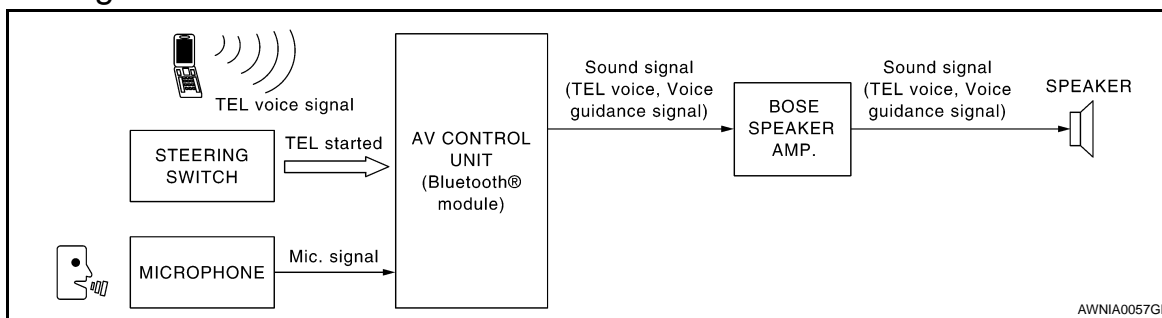

### System Description

INFOID:000000003214792

Refer to the owner's manual for Bluetooth telephone system operating instructions.

#### NOTE:

Cellular telephones must have their wireless connection set up (paired) before using the Bluetooth telephone system.

Bluetooth telephone system allows users who have a Bluetooth cellular telephone to make a wireless connection between their cellular telephone and the AV control unit. Hands-free cellular telephone calls can be sent and received. Personal memos can be created using the Nissan Voice Recognition system. Some Bluetooth cellular telephones may not be recognized by the AV control unit. When a cellular telephone or the AV control unit is replaced, the telephone must be paired with the AV control unit. Different cellular telephones may have different pairing procedures. Refer to the cellular telephone operating manual.

#### AV CONTROL UNIT

When the ignition switch is turned to ACC or ON, the AV control unit will power up. During power up, the AV control unit is initialized and performs various self checks. Initialization may take up to 10 seconds. During this time the Bluetooth ON indicator will flash until initialization is complete. If a phone is present in the vehicle and paired with the AV control unit, Nissan Voice Recognition will then become active and the Bluetooth ON indicator will remain on. Bluetooth telephone functions can be turned off using the Nissan Voice Recognition system.

#### STEERING WHEEL AUDIO CONTROL SWITCHES

When buttons on the steering wheel audio control switch are pushed, the resistance in steering wheel audio control switch circuit changes depending on which button is pushed. The AV control unit uses this signal to perform various functions while navigating through the voice recognition system.

The following functions can be performed using the steering wheel audio control switch:

- Initiate Self-Diagnosis of the Bluetooth telephone system
- Start a voice recognition session
- Answer and end telephone calls
- Adjust the volume of calls
- Record memos

#### MICROPHONE

The microphone is located in the roof console assembly. The microphone sends a signal to the AV control unit. The microphone can be actively tested during self-diagnosis.

# HANDS FREE PHONE SYSTEM (SEDAN)

< FUNCTION DIAGNOSIS >

[BOSE AUDIO WITH NAVIGATION]

## Component Parts Location

INFOID:000000003220902

A

B

C

D

E

F

G

H

I

J

K

L

M

AV

O

P

# HANDS FREE PHONE SYSTEM (SEDAN)

< FUNCTION DIAGNOSIS >

[BOSE AUDIO WITH NAVIGATION]

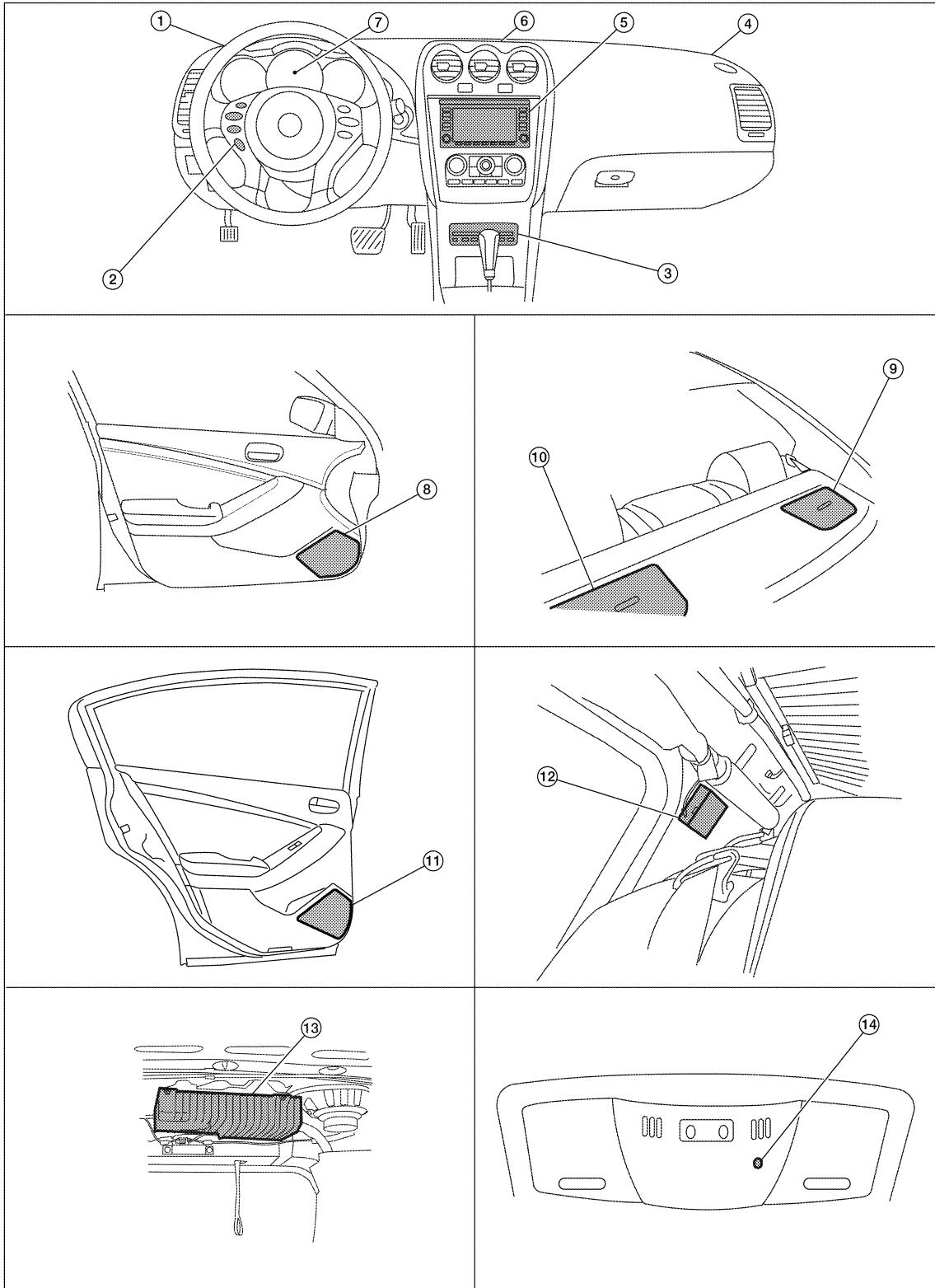

AWNIA0760ZZ

# HANDS FREE PHONE SYSTEM (SEDAN)

< FUNCTION DIAGNOSIS >

[BOSE AUDIO WITH NAVIGATION]

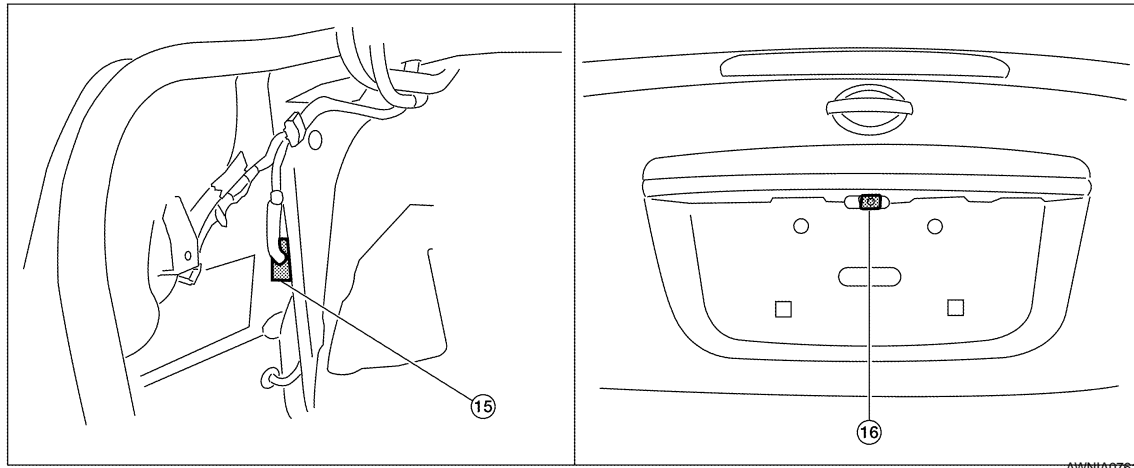

- |                                  |   |  |
|----------------------------------|---|--|
| 1. Tweeter LH M51                | 2. Steering wheel audio control switches        | 3. CD changer M42  |
| 4. Tweeter RH M52                | 5. AV control unit M46, M47, M48, M81, M90, M91 | 6. Center speaker M151   |
| 7. Combination meter M24         | 8. Front door speaker LH D3<br>RH D103          | 9. Rear subwoofer RH B124  |
| 10. Rear subwoofer LH B120       | 11. Rear door speaker LH D202<br>RH D302        | 12. Antenna amp M502 (view with rear pillar finisher RH removed)                 |
| 13. BOSE speaker amp. B121, B122 | 14. Microphone R7                               | 15. Rear view camera control unit B31 (view with trunk side finisher LH removed) |
| 16. Rear view camera B35         |   |  |

## Component Description

INFOID:000000003214794

Part name	Description
AV control unit	<ul style="list-style-type: none"> <li>Controls hands-free phone functions</li> <li>Displays hands-free phone information on display screen</li> </ul>
BOSE speaker amp.	Inputs power (amp ON) and sound signal from AV control unit, and outputs sound signal to each speaker.
Front door speaker	<ul style="list-style-type: none"> <li>Outputs audio signal from BOSE speaker amp.</li> <li>Outputs high, mid and low range sounds</li> </ul>
Tweeter	<ul style="list-style-type: none"> <li>Outputs audio signal from BOSE speaker amp.</li> <li>Outputs high range sound</li> </ul>
Center speaker	<ul style="list-style-type: none"> <li>Outputs audio signal from BOSE speaker amp.</li> <li>Outputs high, mid and low range sounds</li> </ul>
Steering wheel audio control switches	<ul style="list-style-type: none"> <li>Start a voice recognition session</li> <li>Answer and end telephone calls</li> <li>Adjust the volume level</li> </ul>
Microphone	Sends voice signals to AV control unit

# DIAGNOSIS SYSTEM (AV CONTROL UNIT)

< FUNCTION DIAGNOSIS >

[BOSE AUDIO WITH NAVIGATION]

## DIAGNOSIS SYSTEM (AV CONTROL UNIT)

### Diagnosis Description

INFOID:000000001830476

#### DESCRIPTION

- Diagnosis function consists of the self-diagnosis mode performed automatically and the CONFIRMATION/ADJUSTMENT mode operated manually.
- Self-diagnosis mode checks for connections between the units constituting this system, analyzes each individual unit at the same time, and displays the results on the LCD screen.
- CONFIRMATION/ADJUSTMENT mode is used to perform trouble diagnosis that requires operation and judgment by an operator (trouble that cannot be automatically judged by the system), to check/change the set value, and to display the History of Errors of the multi AV system.

#### DIAGNOSIS ITEM

Mode		Description	
Self-diagnosis		<ul style="list-style-type: none"> <li>• AV control unit diagnosis (DVD-ROM drive will not be diagnosed when no map DVD-ROM is in it.</li> <li>• Analyzes connection between the AV control unit, CD changer, satellite radio antenna and GPS antenna.</li> </ul>	
CONFIRMATION/ ADJUSTMENT	Display diagnosis	Color spectrum bar	Color tone of the screen can be checked by the display of a color bar.
		Gradation bar	Shading of the screen can be checked by the display of a gray scale.
		Touch panel	<ul style="list-style-type: none"> <li>• Touch panel response can be checked.</li> <li>• Touch panel calibration can be performed.</li> </ul>
	Vehicle signals		The following vehicle signals are analyzed: Vehicle speed signal, parking brake signal, light signal, ignition switch signal, and reverse signal.
	Speaker test		Connection can be checked by sending a test tone to each speaker.
	Navigation		XM NavTraffic subscription status can be checked.
	Error history		Diagnosis results previously stored in the memory are displayed in this mode.
	Vehicle CAN diagnosis		The transmitting/receiving of CAN communication can be monitored.
	Handsfree phone	Handsfree volume adjustment	Volume of hands-free phone can be adjusted.
		Voice microphone test	Hands-free phone microphone can be tested.
		Delete handsfree memory	Hands-free phone memory can be deleted.
	Bluetooth	Confirm / Change Passkey	Bluetooth passkey can be changed.
		Confirm / Change Device Key	Bluetooth device name can be changed.
	XM SAT		Traffic channel information can be reviewed and changed.

#### OPERATION PROCEDURE

1. Start the engine.
2. Turn the audio system off.
3. While pressing the "SETUP" button, turn the volume control dial clockwise or counterclockwise for 30 clicks or more. (When the self-diagnosis mode is started, a short beep will be heard.)

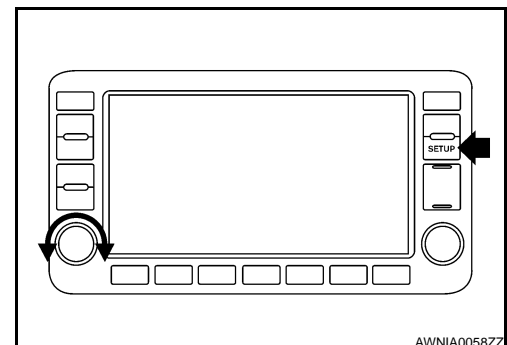

AWNIA0058ZZ

# DIAGNOSIS SYSTEM (AV CONTROL UNIT)

[BOSE AUDIO WITH NAVIGATION]

< FUNCTION DIAGNOSIS >

- The initial trouble diagnosis screen will be displayed, and items “Self-Diagnosis” and “Confirmation/Adjustment” can be selected.

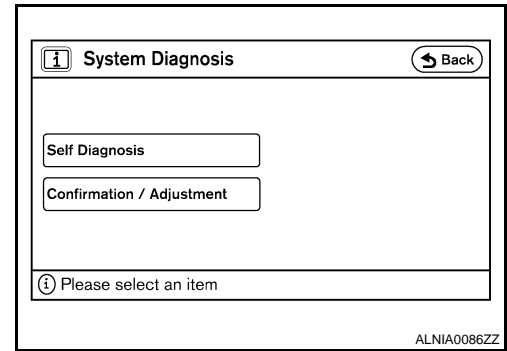

## SELF-DIAGNOSIS

- Perform self-diagnosis by selecting “Self-diagnosis”.
  - Self-diagnosis subdivision screen is displayed, and the self-diagnosis mode starts.
  - A bar graph visible on the center of the self-diagnosis subdivision screen indicates progress of the trouble diagnosis.

**NOTE:**

Self-diagnosis requires approximately 10 seconds to complete.

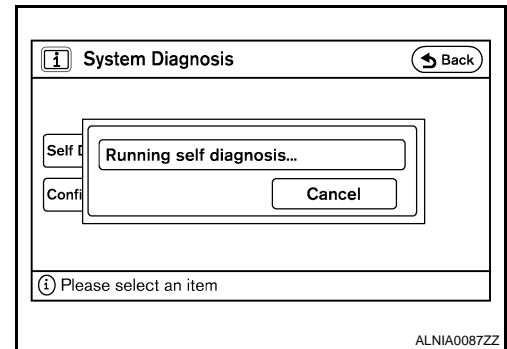

- Diagnosis results are displayed after the self-diagnosis is completed. The unit names and the connection lines are color-coded according to the diagnostic results.

Diagnosis results	Unit	Connection line
Normal	Green	Green
Connection malfunction	Gray	Yellow
Unit malfunction <sup>Note</sup>	Red	Green

Note:

- Only the control unit (AV control unit) is displayed in red.
- If multiple malfunctions occur at the same time for a single unit, the screen switch colors are determined according to the following order of priority: red > yellow > gray.

- Select a switch on the “SELF DIAGNOSIS” screen and comments for the diagnosis results will be shown.

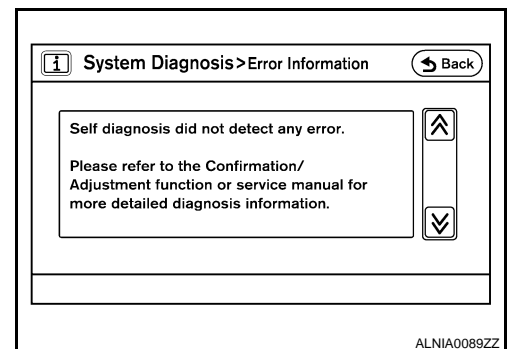
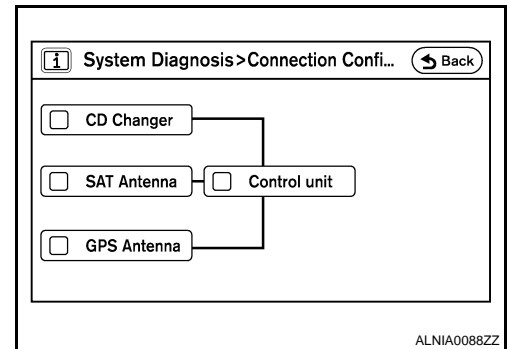

Self-Diagnosis Results

A  
B  
C  
D  
E  
F  
G  
H  
I  
J  
K  
L  
M  
O  
P

AV

# DIAGNOSIS SYSTEM (AV CONTROL UNIT)

< FUNCTION DIAGNOSIS >

[BOSE AUDIO WITH NAVIGATION]

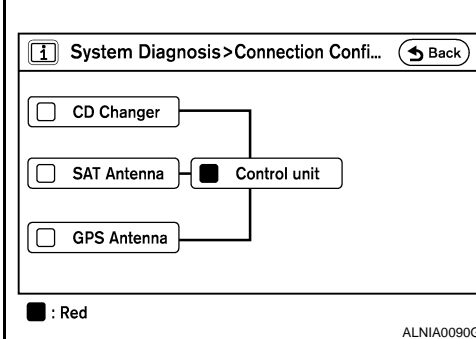
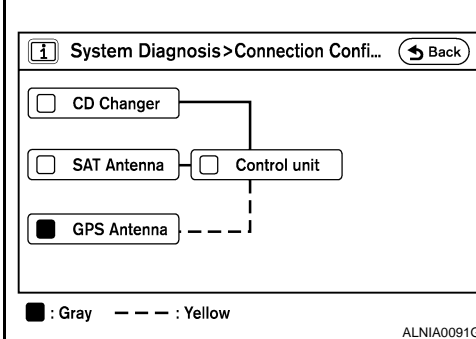
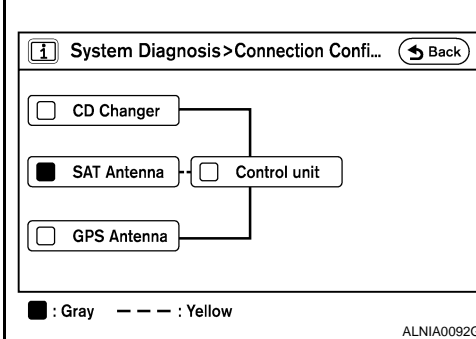
Area with yellow connection lines	Description	Possible malfunction location / Action to take
 <p>System Diagnosis &gt; Connection Conf... <span>Back</span></p> <p>CD Changer</p> <p>SAT Antenna <input checked="" type="checkbox"/> Control unit</p> <p>GPS Antenna</p> <p>■ : Red</p> <p>ALNIA0090GB</p>	<p>AV control unit malfunction is detected</p>	<p>Possible malfunction location / Action to take</p> <p>Replace the AV control unit. Refer to <a href="#">AV-422, "Removal and Installation"</a>.</p>
 <p>System Diagnosis &gt; Connection Conf... <span>Back</span></p> <p>CD Changer</p> <p>SAT Antenna <input type="checkbox"/> Control unit</p> <p>■ GPS Antenna</p> <p>■ : Gray --- : Yellow</p> <p>ALNIA0091GB</p>	<p>GPS antenna connection malfunction is detected</p>	<p>GPS antenna</p>
 <p>System Diagnosis &gt; Connection Conf... <span>Back</span></p> <p>CD Changer</p> <p>■ SAT Antenna <input type="checkbox"/> Control unit</p> <p>GPS Antenna</p> <p>■ : Gray --- : Yellow</p> <p>ALNIA0092GB</p>	<p>Poor connection is detected in satellite antenna</p>	<ul style="list-style-type: none"> <li>• Satellite antenna feeder</li> <li>• Satellite antenna</li> </ul>



# DIAGNOSIS SYSTEM (AV CONTROL UNIT)

< FUNCTION DIAGNOSIS >

[BOSE AUDIO WITH NAVIGATION]

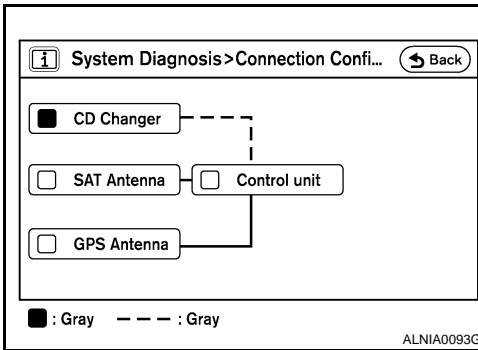
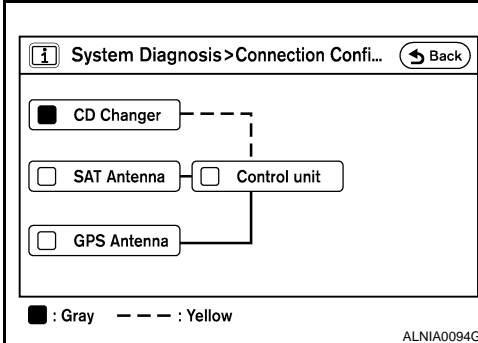
Area with yellow connection lines	Description	Possible malfunction location / Action to take
	<p>No diagnosis due to internal malfunction of CD changer</p>	<p>Replace the CD changer. Refer to <a href="#">AV-424. "Removal and Installation"</a>.</p>
	<ul style="list-style-type: none"> <li>• CD changer power supply and ground circuits</li> <li>• A malfunction is detected in communication circuit between AV control unit and CD changer (REQ1 signal or communication signal)</li> <li>• A malfunction is detected in communication signal between AV control unit and CD changer (REQ1 signal or communication signal)</li> </ul>	<ul style="list-style-type: none"> <li>• CD changer power supply and ground circuits</li> <li>• Communication line between AV control unit and CD changer (REQ1 signal or communication signal)</li> </ul>

## CONFIRMATION/ADJUSTMENT MODE

1. Start the diagnosis function and select "Confirmation/Adjustment". The confirmation/adjustment mode indicates where each item can be checked or adjusted.
2. Select each button on the "Confirmation/Adjustment Mode" screen to display the relevant trouble diagnosis screen. Press the "BACK" button to return to the initial Confirmation/Adjustment Mode screen.

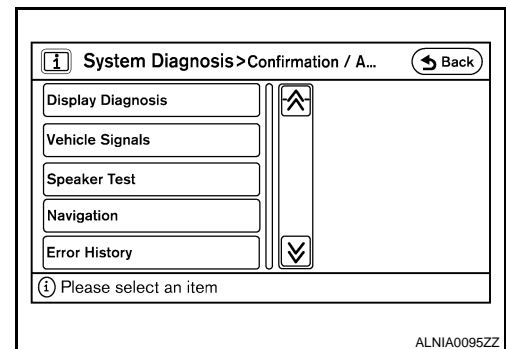

A  
B  
C  
D  
E  
F  
G  
H  
I  
J  
K  
L  
M  
N  
O  
P

AV

# DIAGNOSIS SYSTEM (AV CONTROL UNIT)

< FUNCTION DIAGNOSIS >

[BOSE AUDIO WITH NAVIGATION]

## Display Diagnosis

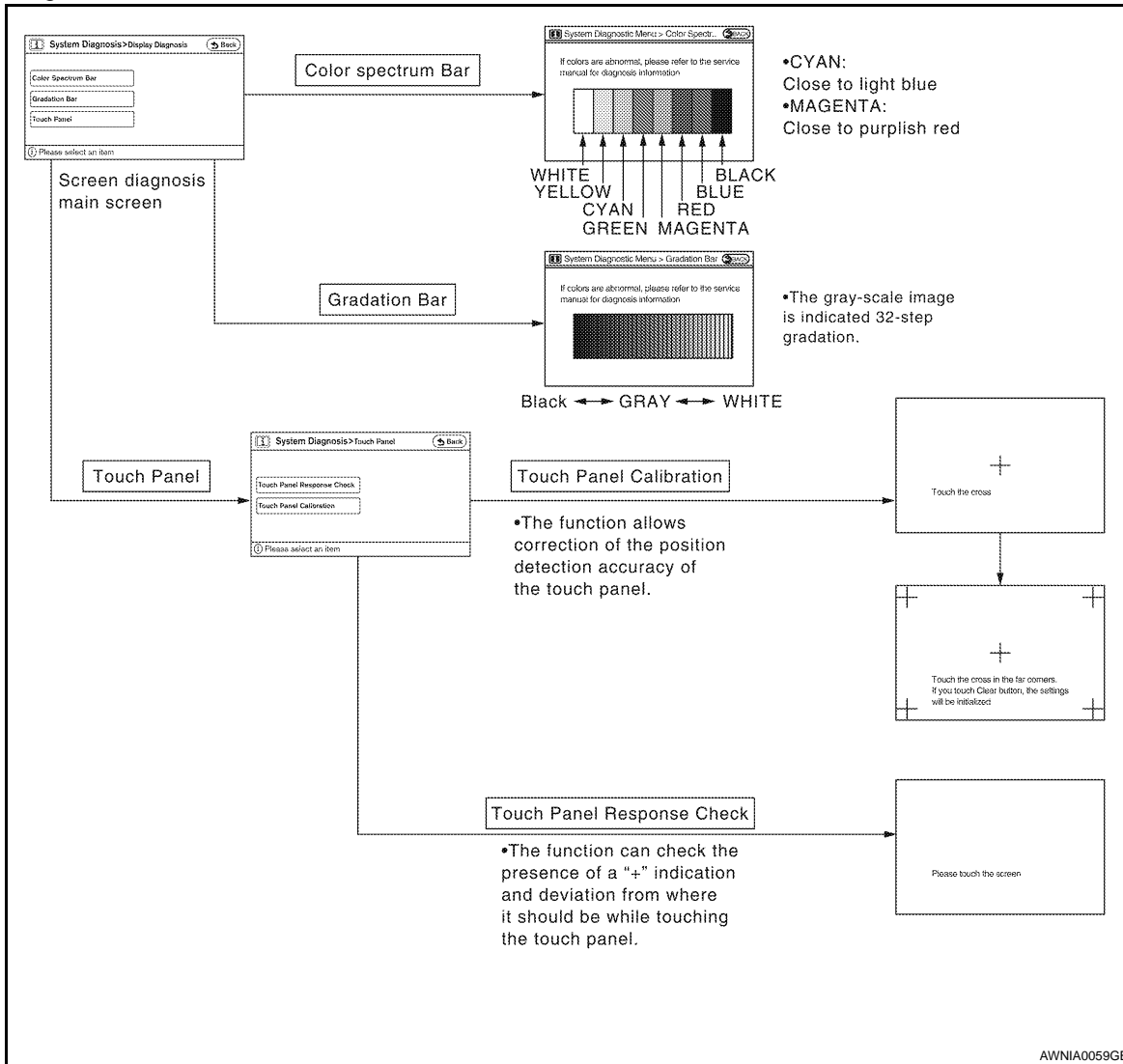

## Vehicle Signals

A comparison check can be made of each actual vehicle signal and the signals recognized by the system.

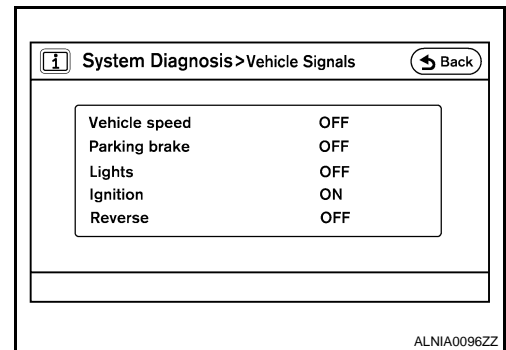

Diagnosis item	Display	Vehicle status	Remarks
Vehicle speed	ON	Vehicle speed > 0 km/h	Changes in indication may be delayed by approximately 1.5 seconds. This is normal.
	OFF	Vehicle speed = 0 km/h	
	-	Ignition switch in ACC position	
Parking brake	ON	Parking brake is applied.	
	OFF	Parking brake is released.	

# DIAGNOSIS SYSTEM (AV CONTROL UNIT)

< FUNCTION DIAGNOSIS >

[BOSE AUDIO WITH NAVIGATION]

Diagnosis item	Display	Vehicle status	Remarks
Lights	ON	Light switch ON	Block the light beam from the auto light optical sensor.
	OFF	Light switch OFF	
Ignition	ON	Ignition switch ON	—
	OFF	Ignition switch in ACC position	
Reverse	ON	Selector lever in R position	Changes in indication may be delayed by approximately 1.5 seconds. This is normal.
	OFF	Selector lever in any position other than R	
	—	Ignition switch in ACC position	

## Speaker Test

Select "SPEAKER TEST" to display the speaker diagnosis screen. Press "START" to generate a test tone in speakers. Press "End" to stop the test tones.

### NOTE:

The speakers are tested in the following order:

Front left tweeter > front center > front right tweeter > front right > rear right > woofer > rear left > front left

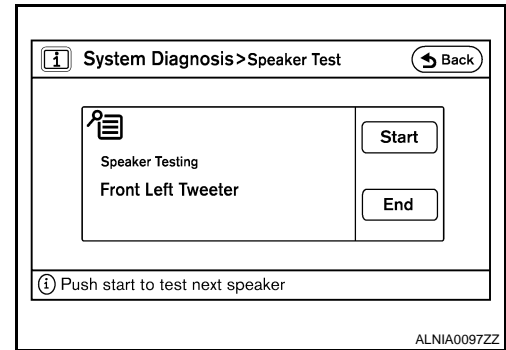

## Navigation

The XM NavTraffic subscription status can be checked.

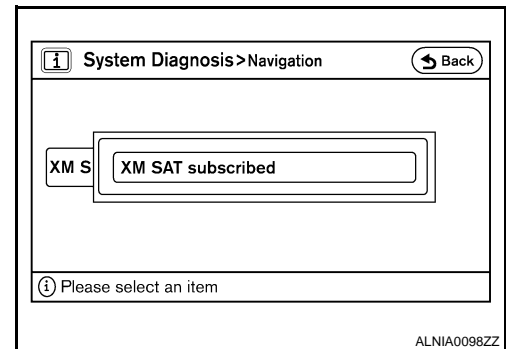

## Error History

The error record displays the time and place of the most recent occurrence of that error. However, take note of the following points.

- If there is a malfunction with the GPS antenna circuit board in the AV control unit, the correct date and time of occurrence may not be able to be displayed.
- Place of the error occurrence is represented by the position of the current location mark at the time an error occurred. If current location mark has deviated from the correct position, then the place of the error occurrence cannot be located correctly.

## Vehicle CAN Diagnosis

A  
B  
C  
D  
E  
F  
G  
H  
I  
J  
K  
L  
M  
AV  
O  
P

# DIAGNOSIS SYSTEM (AV CONTROL UNIT)

[BOSE AUDIO WITH NAVIGATION]

## < FUNCTION DIAGNOSIS >

- CAN communication status and error counter is displayed.
- The error counter displays “OK” if any malfunction was not detected in the past and displays “0” if a malfunction is detected. It increases by 1 if the condition is normal at the next ignition switch ON cycle. The upper limit of the counter is 39.
- The error counter is erased if reset.

Items	Display (Current)	Malfunction counter (Past)
Rx (ECM)	OK / UNKWN	OK / 0 - 39
Rx (Cluster)	OK / UNKWN	OK / 0 - 39
Rx (HEV)	not used	—

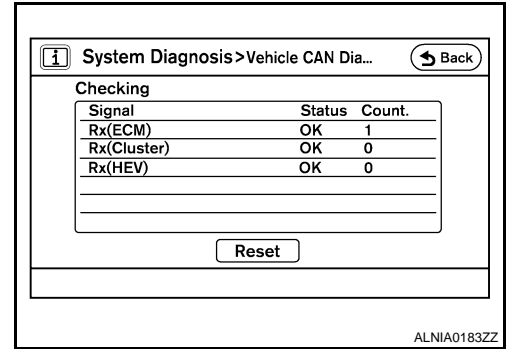

### Handsfree Phone

The hands-free phone reception volume adjustment, microphone test and memory erase functions are available.

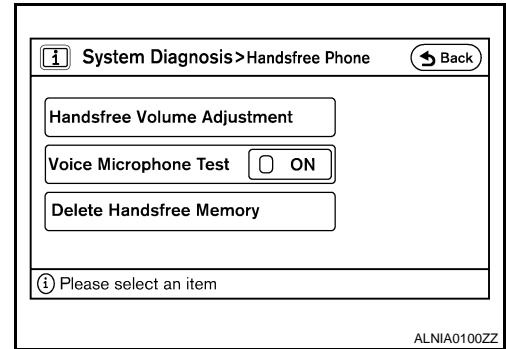

### Bluetooth

#### Passkey confirmation/change

- The passkey of Bluetooth can be confirmed and changed.
- The passkey can be changed by four digits within 0 to 9.

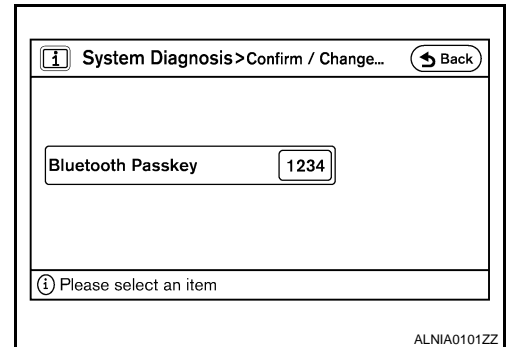

#### Device name confirmation/change

- The device name of Bluetooth can be confirmed and changed.
- The device name can be changed by sixteen digits within A to Z (small character can be used) and - (hyphen).

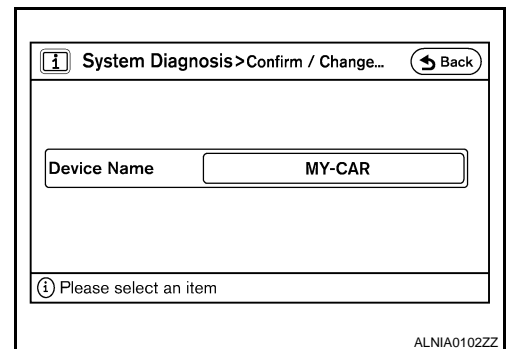

### XM SAT

# DIAGNOSIS SYSTEM (AV CONTROL UNIT)

[BOSE AUDIO WITH NAVIGATION]

## < FUNCTION DIAGNOSIS >

- Change Channel
  - Any necessary channels required to receive traffic information from the satellite radio system can be set.

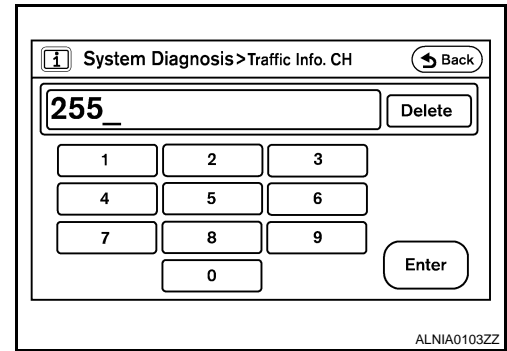

- Change Application ID
  - Any application ID's required to receive traffic information from the satellite radio system can be set.

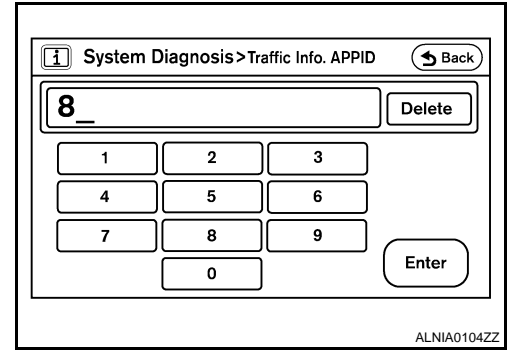

- Change EXT ID
  - Any EXT ID's required to receive traffic information from the satellite radio system can be set.

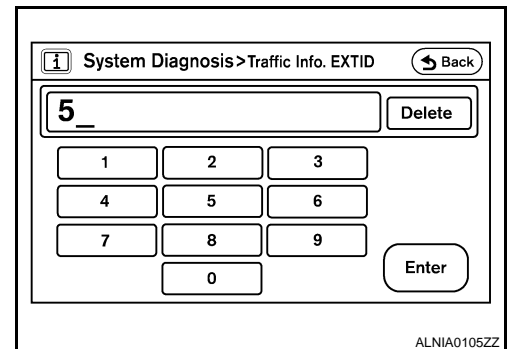

## CONSULT - III Function (MULTI AV)

INFOID:000000001830477

CONSULT-III can display each diagnostic item using the diagnostic test modes shown following.

MULTI AV diagnosis mode	Description
SELF-DIAG RESULTS	Displays AV control unit self-diagnosis results.
DATA MONITOR	Displays AV control unit input/output data in real time.
CAN DIAG SUPPORT MNTR	The result of transmit/receive diagnosis of CAN communication can be read.
AV COMM MONITOR	Allows the technician to monitor the status of the Multi AV system communication signals.
ECU PART NUMBER	The part number of AV control unit can be checked.

### SELF-DIAG RESULTS

Display Item List

Refer to [AV-377, "DTC Index"](#).

### DATA MONITOR

Display Item List

A  
B  
C  
D  
E  
F  
G  
H  
I  
J  
K  
L  
M  
AV  
O  
P

# DIAGNOSIS SYSTEM (AV CONTROL UNIT)

< FUNCTION DIAGNOSIS >

[BOSE AUDIO WITH NAVIGATION]

Display item [unit]	ALL SIGNALS	SELECTION FROM MENU	Description
VHCL SPD SIG [ON/OFF]	X	X	Displays "ON" when vehicle speed > 0 km/h. Displays "OFF" when vehicle speed = 0 km/h.
PKB SIG [ON/OFF]	X	X	Displays [ON/OFF] condition of parking brake switch.
ILLUM SIG [ON/OFF]	X	X	Displays [ON/OFF] condition of lighting switch.
IGN SIG [ON/OFF]	X	X	Displays [ON/OFF] condition of ignition switch.
REV SIG [ON/OFF]	X	X	Displays [ON/OFF] condition of back-up lamp switch.

# U1000 CAN COMM CIRCUIT

< COMPONENT DIAGNOSIS >

[BOSE AUDIO WITH NAVIGATION]

## COMPONENT DIAGNOSIS

### U1000 CAN COMM CIRCUIT

#### Description

INFOID:0000000001830478

Refer to [AV-232, "System Description"](#).

#### DTC Logic

INFOID:0000000001830479

#### DTC DETECTION LOGIC

DTC	CONSULT-III display	Detection condition
U1000	CAN COMM CIRCUIT [U1000]	When AV control unit is not transmitting or receiving CAN communication signals for 2 seconds or more.

#### Diagnosis Procedure

INFOID:0000000001830480

Symptom: Displays "CAN COMM CIRCUIT [U1000]" as a self-diagnosis result of AV control unit.

#### 1. CHECK CAN COMMUNICATION

Select "SELF-DIAG RESULTS" mode for "MULTI AV" with CONSULT-III.

>> Go to "LAN system". Refer to [LAN-10, "Condition of Error Detection"](#).

A  
B  
C  
D  
E  
F  
G  
H  
I  
J  
K  
L  
M  
O  
P

AV

# U1010 CONTROL UNIT (CAN)

[BOSE AUDIO WITH NAVIGATION]

< COMPONENT DIAGNOSIS >

## U1010 CONTROL UNIT (CAN)

### Description

INFOID:000000001830481

Refer to [LAN-9, "Description"](#).

### DTC Logic

INFOID:000000001830482

### DTC DETECTION LOGIC

DTC	CONSULT-III display	Detection condition
U1010	CONTROL UNIT (CAN) [U1010]	When a malfunction is detected during initial diagnosis for CAN controller of each control unit.

### Diagnosis Procedure

INFOID:000000001830483

Symptom: Displays "CONTROL UNIT (CAN) [U1010]" as a self-diagnosis result of AV control unit.

#### 1. CHECK CAN COMMUNICATION

Select "SELF-DIAG RESULTS" mode for "MULTI AV" with CONSULT-III.

>> Go to "LAN system". Refer to [LAN-10, "Condition of Error Detection"](#).



# U1200 AV CONTROL UNIT

< COMPONENT DIAGNOSIS >

[BOSE AUDIO WITH NAVIGATION]

## U1200 AV CONTROL UNIT

### Description

INFOID:000000001830484

Refer to [AV-232, "System Description"](#).

### DTC Logic

INFOID:000000001830485

### DTC DETECTION LOGIC

DTC	CONSULT-III display	Detection condition	Action to take
U1200	Cont Unit FLASH-ROM [U1200]	An internal malfunction is detected in AV control unit (FLASH-ROM).	Replace AV control unit. Refer to <a href="#">AV-422, "Removal and Installation"</a> .

A  
B  
C  
D  
E  
F  
G  
H  
I  
J  
K  
L  
M  
O  
P

AV

# U1201 AV CONTROL UNIT

< COMPONENT DIAGNOSIS >

[BOSE AUDIO WITH NAVIGATION]

## U1201 AV CONTROL UNIT

### Description

INFOID:000000001830486

Refer to [AV-232. "System Description"](#).

### DTC Logic

INFOID:000000001830487

### DTC DETECTION LOGIC

DTC	CONSULT-III display	Detection condition	Action to take
U1201	GYRO NO CONN [U1201]	An internal malfunction is detected in AV control unit (gyrocompass disconnection).	Replace AV control unit. Refer to <a href="#">AV-422. "Removal and Installation"</a> .

# U1204 GPS COMM

< COMPONENT DIAGNOSIS >

[BOSE AUDIO WITH NAVIGATION]

## U1204 GPS COMM

### Description

INFOID:000000001830488

Refer to [AV-232, "System Description"](#).

### DTC Logic

INFOID:000000001830489

### DTC DETECTION LOGIC

DTC	CONSULT-III display	Detection condition	Action to take
U1204	GPS COMM [U1204]	An internal malfunction is detected in AV control unit (GPS malfunction).	Replace AV control unit. Refer to <a href="#">AV-422, "Removal and Installation"</a> .

A  
B  
C  
D  
E  
F  
G  
H  
I  
J  
K  
L  
M  
O  
P

AV

**U1205 GPS ROM**

**Description**

INFOID:000000001830490

Refer to [AV-232. "System Description"](#).

**DTC Logic**

INFOID:000000001830491

**DTC DETECTION LOGIC**

DTC	CONSULT-III display	Detection condition	Action to take
U1205	GPS ROM [U1205]	An internal malfunction is detected in AV control unit (GPS malfunction).	Replace AV control unit. Refer to <a href="#">AV-422. "Removal and Installation"</a> .

# U1206 GPS RAM

< COMPONENT DIAGNOSIS >

[BOSE AUDIO WITH NAVIGATION]

## U1206 GPS RAM

### Description

INFOID:000000001830492

Refer to [AV-232, "System Description"](#).

### DTC Logic

INFOID:000000001830493

### DTC DETECTION LOGIC

DTC	CONSULT-III display	Detection condition	Action to take
U1206	GPS RAM [U1206]	An internal malfunction is detected in AV control unit (GPS malfunction).	Replace AV control unit. Refer to <a href="#">AV-422, "Removal and Installation"</a> .

A  
B  
C  
D  
E  
F  
G  
H  
I  
J  
K  
L  
M  
O  
P

AV

# U1207 GPS RTC

< COMPONENT DIAGNOSIS >

[BOSE AUDIO WITH NAVIGATION]

## U1207 GPS RTC

### Description

INFOID:000000001830494

Refer to [AV-232. "System Description"](#).

### DTC Logic

INFOID:000000001830495

### DTC DETECTION LOGIC

DTC	CONSULT-III display	Detection condition	Action to take
U1207	GPS RTC [U1207]	An internal malfunction is detected in AV control unit (GPS malfunction).	Replace AV control unit. Refer to <a href="#">AV-422. "Removal and Installation"</a> .

# U1208 DVD-ROM COMM

< COMPONENT DIAGNOSIS >

[BOSE AUDIO WITH NAVIGATION]

## U1208 DVD-ROM COMM

### Description

INFOID:000000001830496

Refer to [AV-232, "System Description"](#).

### DTC Logic

INFOID:000000001830497

### DTC DETECTION LOGIC

DTC	CONSULT-III display	Detection condition
U1208	DVD-ROM COMM [U1208]	An internal malfunction is detected in AV control unit (DVD-ROM).

### Diagnosis Procedure

INFOID:000000001830498

#### 1. CHECK DVD-ROM

Check DVD-ROM for dirt, scratches and warpage.

Is the DVD-ROM clean and undamaged?

- OK >> Replace AV control unit. Refer to [AV-422, "Removal and Installation"](#).
- NG >> Replace DVD-ROM map.

A  
B  
C  
D  
E  
F  
G  
H  
I  
J  
K  
L  
M  
O  
P

AV

# U1209 DVD-ROM READ

< COMPONENT DIAGNOSIS >

[BOSE AUDIO WITH NAVIGATION]

## U1209 DVD-ROM READ

### Description

INFOID:000000001830499

Refer to [AV-232, "System Description"](#).

### DTC Logic

INFOID:000000001830500

### DTC DETECTION LOGIC

DTC	CONSULT-III display	Detection condition
U1209	DVD-ROM READ [U1209]	An internal malfunction is detected in AV control unit (DVD-ROM).

### Diagnosis Procedure

INFOID:000000001830501

#### 1. CHECK DVD-ROM

Check DVD-ROM for dirt, scratches and warpage.

Is the DVD-ROM clean and undamaged?

- YES >> Replace AV control unit. Refer to [AV-422, "Removal and Installation"](#).
- NO >> Replace DVD-ROM map.



# U120A DVD-ROM DISC

< COMPONENT DIAGNOSIS >

[BOSE AUDIO WITH NAVIGATION]

## U120A DVD-ROM DISC

### Description

INFOID:000000001830502

Refer to [AV-232. "System Description"](#).

### DTC Logic

INFOID:000000001830503

### DTC DETECTION LOGIC

DTC	CONSULT-III display	Detection condition
U120A	DVD-ROM DISC [U120A]	An internal malfunction is detected in AV control unit (DVD-ROM).

### Diagnosis Procedure

INFOID:000000001830504

#### 1. CHECK DVD-ROM

Check DVD-ROM for dirt, scratches and warpage.

Is the DVD-ROM clean and undamaged?

YES >> Replace AV control unit. Refer to [AV-422. "Removal and Installation"](#).

NO >> Replace DVD-ROM map.

A  
B  
C  
D  
E  
F  
G  
H  
I  
J  
K  
L  
M  
O  
P

AV

# U120C DVD-ROM MECHA DETECT

< COMPONENT DIAGNOSIS >

[BOSE AUDIO WITH NAVIGATION]

## U120C DVD-ROM MECHA DETECT

### Description

INFOID:000000001830505

Refer to [AV-232, "System Description"](#).

### DTC Logic

INFOID:000000001830506

### DTC DETECTION LOGIC

DTC	CONSULT-III display	Detection condition
U120C	DVD-ROM MECHA DETECT [U120C]	An internal malfunction is detected in AV control unit (DVD-ROM).

### Diagnosis Procedure

INFOID:000000001830507

#### 1.CHECK DVD-ROM

Check DVD-ROM for dirt, scratches and warpage.

Is the DVD-ROM clean and undamaged?

- YES >> Replace AV control unit. Refer to [AV-422, "Removal and Installation"](#).
- NO >> Replace DVD-ROM map.

# U120D DVD-ROM DRIVE MECHA

< COMPONENT DIAGNOSIS >

[BOSE AUDIO WITH NAVIGATION]

## U120D DVD-ROM DRIVE MECHA

### Description

INFOID:000000001830508

Refer to [AV-232, "System Description"](#).

### DTC Logic

INFOID:000000001830509

### DTC DETECTION LOGIC

DTC	CONSULT-III display	Detection condition
U120D	DVD-ROM MECHA [U120D]	An internal malfunction is detected in AV control unit (DVD-ROM).

### Diagnosis Procedure

INFOID:000000001830510

#### 1. CHECK DVD-ROM

Check DVD-ROM for dirt, scratches and warpage.

Is the DVD-ROM clean and undamaged?

- YES >> Replace AV control unit. Refer to [AV-422, "Removal and Installation"](#).
- NO >> Replace DVD-ROM map.

A  
B  
C  
D  
E  
F  
G  
H  
I  
J  
K  
L  
M  
O  
P

AV

# U1210 DVD-ROM SEEK

< COMPONENT DIAGNOSIS >

[BOSE AUDIO WITH NAVIGATION]

## U1210 DVD-ROM SEEK

### Description

INFOID:000000001830511

Refer to [AV-232. "System Description"](#).

### DTC Logic

INFOID:000000001830512

### DTC DETECTION LOGIC

DTC	CONSULT-III display	Detection condition
U1210	DVD-ROM SEEK [U1210]	An internal malfunction is detected in AV control unit (DVD-ROM).

### Diagnosis Procedure

INFOID:000000001830513

#### 1. CHECK DVD-ROM

Check DVD-ROM for dirt, scratches and warpage.

Is the DVD-ROM clean and undamaged?

YES >> Replace AV control unit. Refer to [AV-422. "Removal and Installation"](#).

NO >> Replace DVD-ROM map.

# U1212 DVD-ROM DATA FORWARD

< COMPONENT DIAGNOSIS >

[BOSE AUDIO WITH NAVIGATION]

## U1212 DVD-ROM DATA FORWARD

### Description

INFOID:000000001830514

Refer to [AV-232, "System Description"](#).

### DTC Logic

INFOID:000000001830515

### DTC DETECTION LOGIC

DTC	CONSULT-III display	Detection condition
U1212	DVD-ROM DATA FORWARD [U1212]	An internal malfunction is detected in AV control unit (DVD-ROM).

### Diagnosis Procedure

INFOID:000000001830516

#### 1. CHECK DVD-ROM

Check DVD-ROM for dirt, scratches and warpage.

Is the DVD-ROM clean and undamaged?

- YES >> Replace AV control unit. Refer to [AV-422, "Removal and Installation"](#).
- NO >> Replace DVD-ROM map.

A  
B  
C  
D  
E  
F  
G  
H  
I  
J  
K  
L  
M  
O  
P

AV

# U1213 DVD-ROM DATA

< COMPONENT DIAGNOSIS >

[BOSE AUDIO WITH NAVIGATION]

## U1213 DVD-ROM DATA

### Description

INFOID:000000001830517

Refer to [AV-232, "System Description"](#).

### DTC Logic

INFOID:000000001830518

### DTC DETECTION LOGIC

DTC	CONSULT-III display	Detection condition
U1213	DVD-ROM DATA [U1213]	An internal malfunction is detected in AV control unit (DVD-ROM).

### Diagnosis Procedure

INFOID:000000001830519

#### 1. CHECK DVD-ROM

Check DVD-ROM for dirt, scratches and warpage.

Is the DVD-ROM clean and undamaged?

- YES >> Replace AV control unit. Refer to [AV-422, "Removal and Installation"](#).
- NO >> Replace DVD-ROM map.

# U1214 DVD-ROM TIMEOUT

< COMPONENT DIAGNOSIS >

[BOSE AUDIO WITH NAVIGATION]

## U1214 DVD-ROM TIMEOUT

### Description

INFOID:000000001830520

Refer to [AV-232, "System Description"](#).

### DTC Logic

INFOID:000000001830521

### DTC DETECTION LOGIC

DTC	CONSULT-III display	Detection condition
U1214	DVD-ROM TIMEOUT [U1214]	An internal malfunction is detected in AV control unit (DVD-ROM).

### Diagnosis Procedure

INFOID:000000001830522

#### 1. CHECK DVD-ROM

Check DVD-ROM for dirt, scratches and warpage.

Is the DVD-ROM clean and undamaged?

- YES >> Replace AV control unit. Refer to [AV-422, "Removal and Installation"](#).
- NO >> Replace DVD-ROM map.

A  
B  
C  
D  
E  
F  
G  
H  
I  
J  
K  
L  
M  
O  
P

AV

# U1215 DVD-ROM LOAD

< COMPONENT DIAGNOSIS >

[BOSE AUDIO WITH NAVIGATION]

## U1215 DVD-ROM LOAD

### Description

INFOID:000000001830523

Refer to [AV-232. "System Description"](#).

### DTC Logic

INFOID:000000001830524

### DTC DETECTION LOGIC

DTC	CONSULT-III display	Detection condition
U1215	DVD-ROM LOAD [U1215]	An internal malfunction is detected in AV control unit (DVD-ROM).

### Diagnosis Procedure

INFOID:000000001830525

#### 1. CHECK DVD-ROM

Check DVD-ROM for dirt, scratches and warpage.

Is the DVD-ROM clean and undamaged?

YES >> Replace AV control unit. Refer to [AV-422. "Removal and Installation"](#).

NO >> Replace DVD-ROM map.



# U1216 AV CONTROL UNIT

< COMPONENT DIAGNOSIS >

[BOSE AUDIO WITH NAVIGATION]

## U1216 AV CONTROL UNIT

### Description

INFOID:000000001830526

Refer to [AV-232, "System Description"](#).

### DTC Logic

INFOID:000000001830527

### DTC DETECTION LOGIC

DTC	CONSULT-III display	Detection condition	Action to take
U1216	CAN CONT [U1216]	An internal malfunction is detected in AV control unit (CAN controller).	Replace AV control unit. Refer to <a href="#">AV-422, "Removal and Installation"</a> .

A  
B  
C  
D  
E  
F  
G  
H  
I  
J  
K  
L  
M  
O  
P

AV

# U1217 AV CONTROL UNIT

< COMPONENT DIAGNOSIS >

[BOSE AUDIO WITH NAVIGATION]

## U1217 AV CONTROL UNIT

### Description

INFOID:000000001830528

Refer to [AV-232. "System Description"](#).

### DTC Logic

INFOID:000000001830529

### DTC DETECTION LOGIC

DTC	CONSULT-III display	Detection condition	Action to take
U1217	BLUETOOTH CONN [U1217]	An internal malfunction is detected in AV control unit (Bluetooth module connection malfunction).	Replace AV control unit. Refer to <a href="#">AV-422. "Removal and Installation"</a> .

# U1220 AV CONTROL UNIT

< COMPONENT DIAGNOSIS >

[BOSE AUDIO WITH NAVIGATION]

## U1220 AV CONTROL UNIT

### Description

INFOID:000000001830530

Refer to [AV-232, "System Description"](#).

### DTC Logic

INFOID:000000001830531

### DTC DETECTION LOGIC

DTC	CONSULT-III display	Detection condition	Action to take
U1220	XM SERIAL COMM [U1220]	An internal malfunction is detected in AV control unit (satellite radio tuner communication malfunction).	Replace AV control unit. Refer to <a href="#">AV-422, "Removal and Installation"</a> .

A  
B  
C  
D  
E  
F  
G  
H  
I  
J  
K  
L  
M  
O  
P

AV

# U1244 GPS ANTENNA

< COMPONENT DIAGNOSIS >

[BOSE AUDIO WITH NAVIGATION]

## U1244 GPS ANTENNA

### Description

INFOID:000000001830532

Refer to [AV-232. "System Description"](#).

### DTC Logic

INFOID:000000001830533

### DTC DETECTION LOGIC

DTC	CONSULT-III display	Detection condition
U1244	GPS ANTENNA CONN [U1244]	GPS antenna connection malfunction is detected.

### Diagnosis Procedure

INFOID:000000001830534

#### 1. GPS ANTENNA CHECK

Inspect GPS antenna and antenna feeder for damage or poor connection.

Is the GPS antenna and feeder clean and undamaged?

YES >> GO TO 2

NO >> Repair or replace malfunctioning parts.

#### 2. CHECK AV CONTROL UNIT VOLTAGE

1. Turn ignition switch ON.
2. Check voltage between AV control unit connector M90 terminal 73 and ground.

**73 - Ground : Approx. 5V**

Is the voltage reading as specified?

YES >> Replace GPS antenna. Refer to [AV-433. "Removal and Installation"](#).

NO >> Replace AV control unit. Refer to [AV-422. "Removal and Installation"](#).

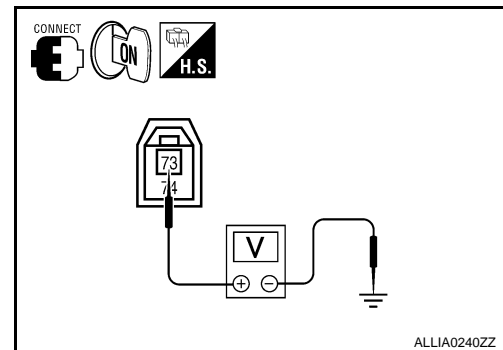

# U124C CD CHANGER

< COMPONENT DIAGNOSIS >

[BOSE AUDIO WITH NAVIGATION]

## U124C CD CHANGER

### Description

INFOID:000000001830535

Refer to [AV-232. "System Description"](#).

### DTC Logic

INFOID:000000001830536

### DTC DETECTION LOGIC

DTC	CONSULT-III display	Detection condition
U124C	N-BUS CD CHG CONN [U124C]	<ul style="list-style-type: none"> <li>A malfunction is detected in CD changer power supply and ground circuits</li> <li>Malfunction occurs in request signal circuit. (Between CD changer and AV control unit)</li> <li>Malfunction occurs in communication signal circuit. (Between CD changer and AV control unit)</li> </ul>

### Diagnosis Procedure

INFOID:000000001830537

#### 1. CHECK CD CHANGER POWER SUPPLY AND GROUND CIRCUIT

Check CD changer power supply and ground circuit. Refer to [AV-310. "CD CHANGER : Diagnosis Procedure"](#).

Do power and ground check OK?

YES >> GO TO 2

NO >> Repair power supply or ground circuit.

#### 2. CHECK COMMUNICATION CIRCUIT CONTINUITY

- Turn ignition switch OFF.
- Disconnect CD changer connector M42 and AV control unit connector M48.
- Check continuity between CD changer harness connector M42 (A) terminals 8, 9 and 10 and AV control unit harness connector M48 (B) terminals 69, 70 and 72.

**8 - 72 : Continuity should exist.**

**9 - 69 : Continuity should exist.**

**10 - 70 : Continuity should exist.**

- Check continuity between CD changer harness connector M42 (A) terminals 8, 9, 10 and ground.

**8, 9, 10 - Ground : Continuity should not exist.**

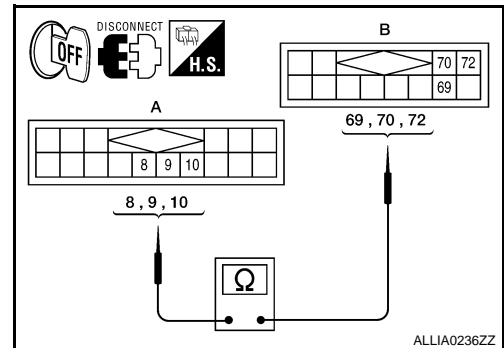

Are the continuity test results as specified?

YES >> GO TO 3

NO >> Repair harness or connector.

#### 3. CHECK REQUEST SIGNAL

- Connect CD changer connector and AV control unit connector.
- Turn ignition switch ON.
- Check signal between CD changer harness connector M42 terminal 8 and ground.

**8 - Ground**

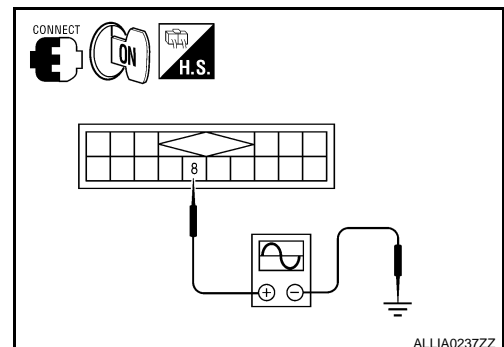
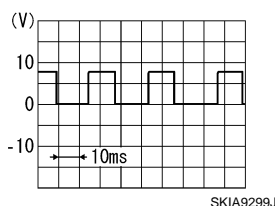

A  
B  
C  
D  
E  
F  
G  
H  
I  
J  
K  
L  
M  
O  
P

AV

# U124C CD CHANGER

[BOSE AUDIO WITH NAVIGATION]

< COMPONENT DIAGNOSIS >

Are the voltage readings as specified?

YES >> GO TO 4

NO >> Replace CD changer. Refer to [AV-424, "Removal and Installation"](#).

## 4. CHECK COMMUNICATION SIGNAL

Check signal between CD changer harness connector M42 terminal 9 and ground.

### 9 - Ground

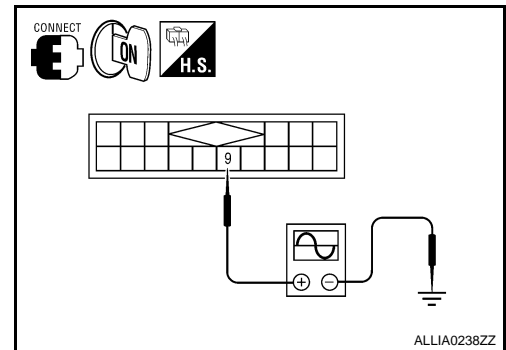
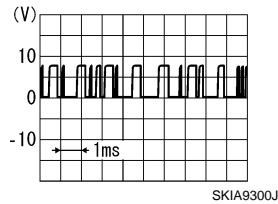

Are the voltage readings as specified?

YES >> GO TO 5

NO >> Replace CD changer. Refer to [AV-424, "Removal and Installation"](#).

## 5. CHECK COMMUNICATION SIGNAL

Check signal between CD changer harness connector M42 terminal 10 and ground.

### 10 - Ground

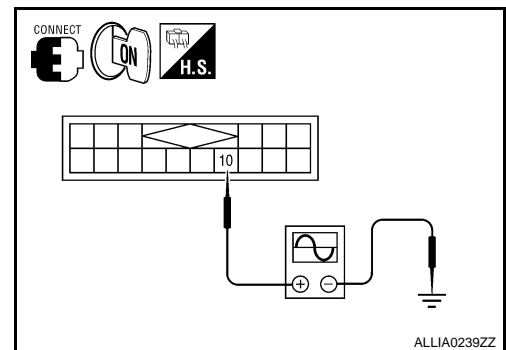
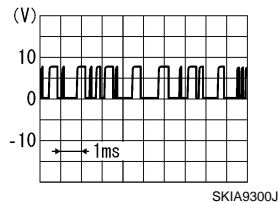

Are the voltage readings as specified?

YES >> Inspection End.

NO >> Replace AV control unit. Refer to [AV-422, "Removal and Installation"](#).

# POWER SUPPLY AND GROUND CIRCUIT (COUPE)

[BOSE AUDIO WITH NAVIGATION]

< COMPONENT DIAGNOSIS >

## POWER SUPPLY AND GROUND CIRCUIT (COUPE)

### AV CONTROL UNIT

#### AV CONTROL UNIT : Diagnosis Procedure

INFOID:000000001830538

#### 1.CHECK FUSE

Check that the following fuses of the AV control unit are not blown.

Unit	Terminals	Signal name	Fuse No.
AV control unit	20	Battery power	24
	7	Ignition switch ACC or ON	19
	10	Ignition switch ON or START	3

Are the fuses OK?

YES >> GO TO 2

NO >> Be sure to eliminate cause of malfunction before installing new fuse.

#### 2.CHECK POWER SUPPLY CIRCUIT

Check voltage between AV control unit harness connector and ground.

(+)		(-)	Ignition switch position	Value (Approx.)
Connector	Terminal			
M47	20	Ground	OFF	Battery voltage
	7		ACC	
	10		ON	

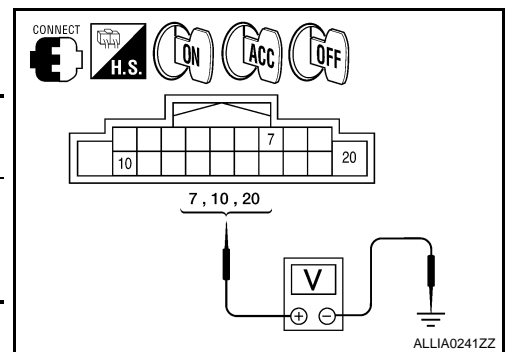

Are the voltage tests as specified?

YES >> GO TO 3

NO >> Check harness between AV control unit and fuse.

#### 3.CHECK GROUND CIRCUIT

1. Turn ignition switch OFF.
2. Disconnect AV control unit connectors.
3. Check continuity between AV control unit harness connector M47 terminal 19 and ground.

Signal name	Continuity
Ground	Continuity should exist.

Does continuity exist?

YES >> Inspection End.

NO >> Repair harness or connector.

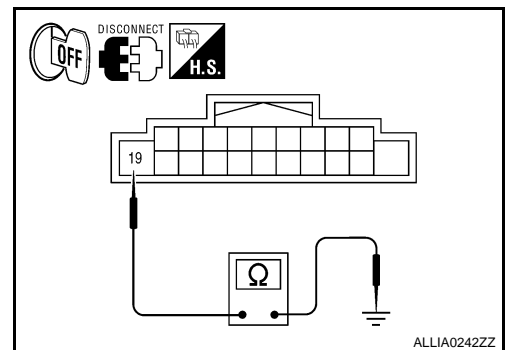

### REAR VIEW CAMERA CONTROL UNIT

#### REAR VIEW CAMERA CONTROL UNIT : Diagnosis Procedure

INFOID:000000001830539

#### 1.CHECK FUSE

Check that the following fuses of the rear view camera control unit are not blown.

Unit	Terminals	Signal name	Fuse No.
Rear view camera control unit	1	Battery power	24
	2	Ignition switch ACC or ON	19

# POWER SUPPLY AND GROUND CIRCUIT (COUPE)

[BOSE AUDIO WITH NAVIGATION]

## < COMPONENT DIAGNOSIS >

### Are the fuses OK?

YES >> GO TO 2

NO >> Be sure to eliminate cause of malfunction before installing new fuse.

## 2.CHECK POWER SUPPLY CIRCUIT

Check voltage between rear view camera control unit harness connector and ground.

(+)		(-)	Ignition switch position	Value (Approx.)
Connector	Terminal			
B31	1	Ground	OFF	Battery voltage
	2		ACC	

### Are the voltage readings as specified?

YES >> GO TO 3

NO >> Check harness between rear view camera control unit and fuse.

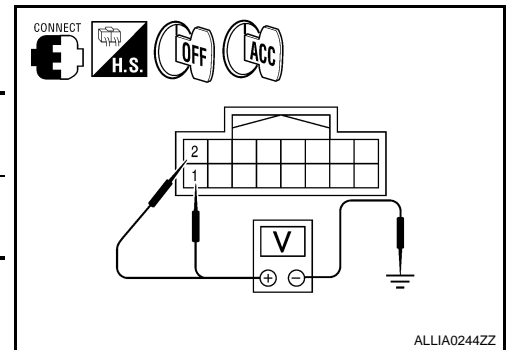

## 3.CHECK GROUND CIRCUIT

1. Turn ignition switch OFF.
2. Disconnect rear view camera control unit connector.
3. Check continuity between rear view camera control unit harness connector B31 terminal 3 and ground.

Signal name	Continuity
Ground	Continuity should exist.

### Does continuity exist?

YES >> Inspection End.

NO >> Repair harness or connector.

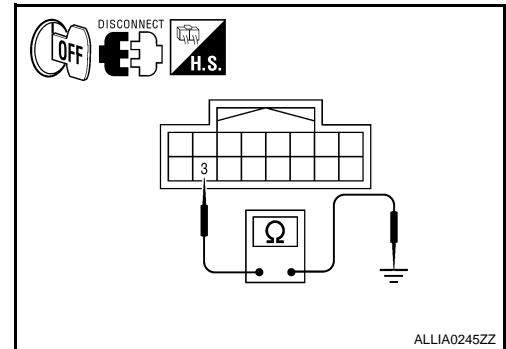

## REAR VIEW CAMERA

### REAR VIEW CAMERA : Diagnosis Procedure

INFOID:000000001830540

## 1.CHECK POWER SUPPLY CIRCUIT (REAR VIEW CAMERA SIDE)

Check voltage between rear view camera harness connector and ground.

(+)		(-)	Transmission position	Value (Approx.)
Connector	Terminal			
T7	1	Ground	Reverse	6V

### Is voltage reading approximately 6 volts?

YES >> GO TO 4

NO >> GO TO 2

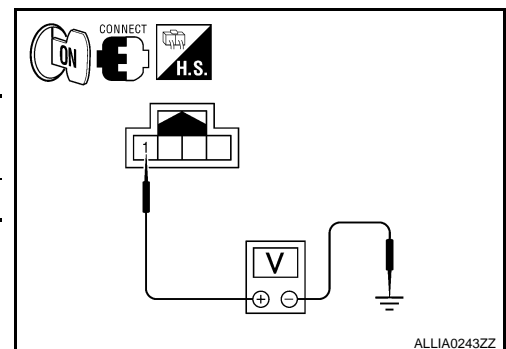

## 2.CHECK POWER SUPPLY CIRCUIT (CONTINUITY)

1. Turn ignition switch OFF.
2. Disconnect rear view camera and rear view camera control unit connectors.



# POWER SUPPLY AND GROUND CIRCUIT (COUPE)

[BOSE AUDIO WITH NAVIGATION]

## < COMPONENT DIAGNOSIS >

- Check continuity between rear view camera harness connector T7 (A) terminal 1 and rear view camera control unit harness connector B31 (B) terminal 8.

Signal name	Continuity
Camera ON signal	Continuity should exist.

- Check continuity between rear view camera harness connector T7 (A) terminal 1 and ground.

Signal name	Continuity
Camera ON signal	Continuity should not exist.

Are continuity test results as specified?

YES >> GO TO 3

NO >> Repair harness or connector.

### 3.CHECK POWER SUPPLY CIRCUIT (CAMERA CONTROL UNIT SIDE)

- Connect rear view camera control unit harness connector.
- Turn ignition switch ON.
- Check voltage between rear view camera control unit harness connector and ground.

(+)		(-)	Condition	Value (Approx.)
Connector	Terminal			
B31	8	Ground	Reverse	6V

Is voltage reading approximately 6 volts?

YES >> Inspection End.

NO >> Replace rear view camera control unit. Refer to [AV-447](#), "[Removal and Installation - Coupe](#)".

### 4.CHECK GROUND CIRCUIT

- Turn ignition switch OFF.
- Disconnect rear view camera harness connector.
- Check continuity between rear view camera harness connector B35 terminal 2 and ground.

Signal name	Continuity
Ground	Continuity should exist.

Does continuity exist?

YES >> Inspection End.

NO >> Repair harness or connector.

## BOSE SPEAKER AMP

### BOSE SPEAKER AMP : Diagnosis Procedure

INFOID:000000001830541

#### 1.CHECK FUSE

Check that the following fuses of the BOSE speaker amp. are not blown.

Unit	Terminals	Signal name	Fuse No.
BOSE speaker amp.	50	Battery power	25
	51		26

Are the fuses OK?

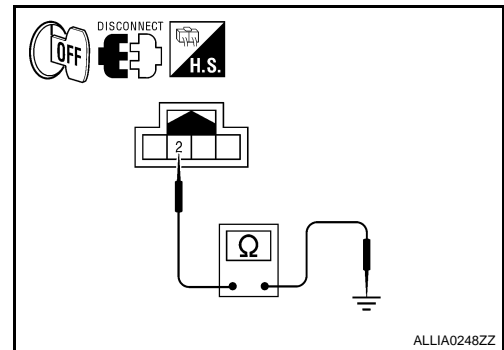
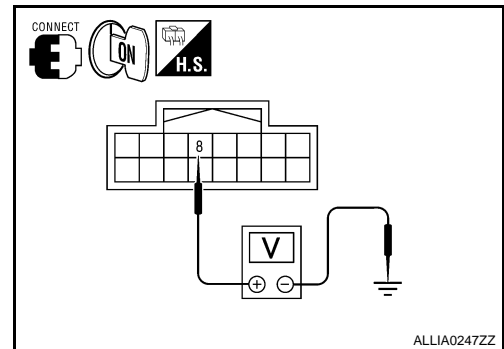
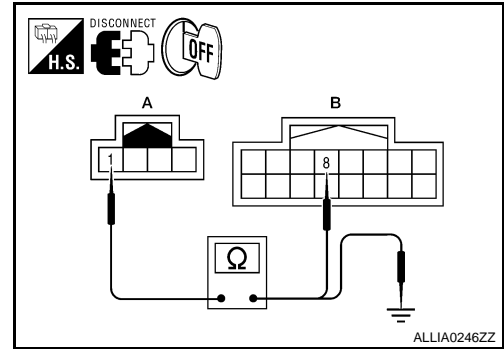

# POWER SUPPLY AND GROUND CIRCUIT (COUPE)

[BOSE AUDIO WITH NAVIGATION]

## < COMPONENT DIAGNOSIS >

- YES >> GO TO 2  
 NO >> Be sure to eliminate cause of malfunction before installing new fuse.

### 2.CHECK POWER SUPPLY CIRCUIT

1. Turn ignition switch OFF.
2. Disconnect BOSE speaker amp connector.
3. Check voltage between BOSE speaker amp harness connector and ground.

(+)		(-)	Voltage (approx.)
Connector	Terminal		
B122	50	Ground	Battery voltage
	51		

Are the voltage readings as specified?

- YES >> GO TO 3  
 NO >> Check harness between BOSE speaker amp. and fuse.

### 3.CHECK GROUND CIRCUIT

1. Turn ignition switch OFF.
2. Disconnect BOSE speaker amp connector.
3. Check continuity between BOSE speaker amp harness connector and ground.

Connector	Terminal	—	Continuity
B122	47	Ground	Yes
	52		

Are continuity test results as specified?

- YES >> Inspection End.  
 NO >> Repair harness or connector.

## CD CHANGER

### CD CHANGER : Diagnosis Procedure

INFOID:000000001830542

#### 1.CHECK FUSE

Check that the following fuses of the CD changer are not blown.

Unit	Terminals	Signal name	Fuse No.
CD changer	12	Battery power	24
	16	Ignition switch ACC or ON	19

Are the fuses OK?

- YES >> GO TO 2  
 NO >> Be sure to eliminate cause of malfunction before installing new fuse.

#### 2.CHECK POWER SUPPLY CIRCUIT

Check voltage between CD changer harness connector and ground.

(+)		(-)	Ignition switch position	Value (Approx.)
Connector	Terminal			
M42	12	Ground	OFF	Battery voltage
	16		ACC	

Are the voltage readings as specified?

- YES >> Inspection End.  
 NO >> Check harness between CD changer and fuse.

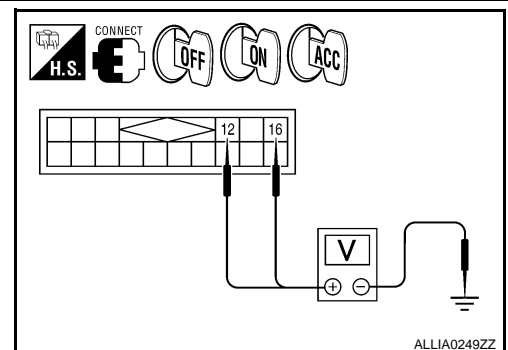
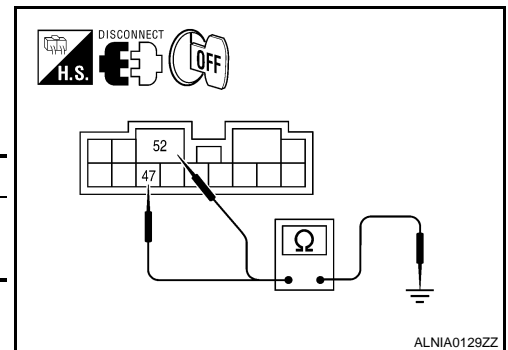
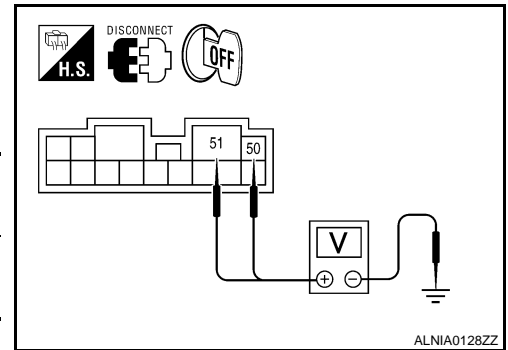

# POWER SUPPLY AND GROUND CIRCUIT (COUPE)

[BOSE AUDIO WITH NAVIGATION]

< COMPONENT DIAGNOSIS >

## MICROPHONE

### MICROPHONE : Diagnosis Procedure

INFOID:000000001830543

#### 1. CHECK POWER SUPPLY CIRCUIT (MICROPHONE SIDE)

Check voltage between microphone harness connector and ground.

(+)		(-)	Ignition switch position	Value (Approx.)
Connector	Terminal			
R7	4	Ground	ON	5V

Is proper voltage present?

YES >> GO TO 4  
NO >> GO TO 2

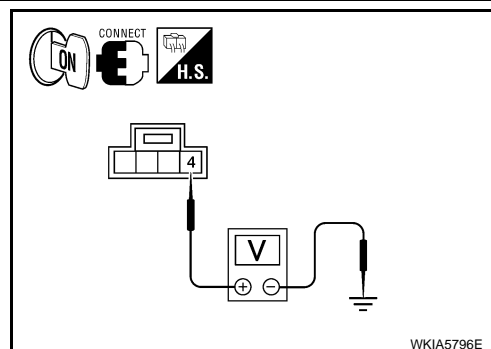

WKIA5796E

#### 2. CHECK POWER SUPPLY CIRCUIT (CONTINUITY)

1. Turn ignition switch OFF.
2. Disconnect microphone and AV control unit harness connectors.
3. Check continuity between microphone harness connector R7 (A) terminal 4 and AV control unit harness connector M46 (B) terminal 46.

Signal name	Continuity
Microphone VCC signal	Continuity should exist.

4. Check continuity between microphone harness connector R7 (A) terminal 4 and ground.

Signal name	Continuity
Microphone VCC signal	Continuity should not exist.

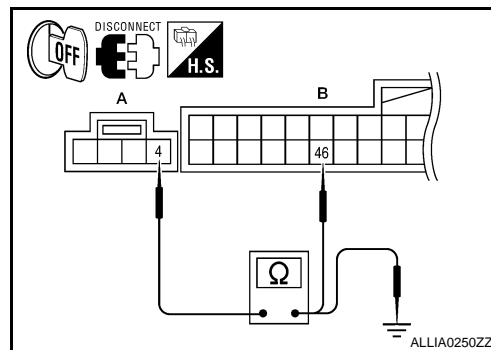

ALLIA0250ZZ

Are the continuity test results as specified?

YES >> GO TO 3  
NO >> Repair harness or connector.

#### 3. CHECK POWER SUPPLY CIRCUIT (AV CONTROL UNIT SIDE)

1. Connect AV control unit harness connector.
2. Turn ignition switch to ACC.
3. Check voltage between AV control unit harness connector and ground.

(+)		(-)	Ignition switch position	Value (Approx.)
Connector	Terminal			
M46	46	Ground	ACC	5V

Is voltage approximately 5 volts?

YES >> Inspection End.  
NO >> Replace AV control unit. Refer to [AV-422. "Removal and Installation"](#).

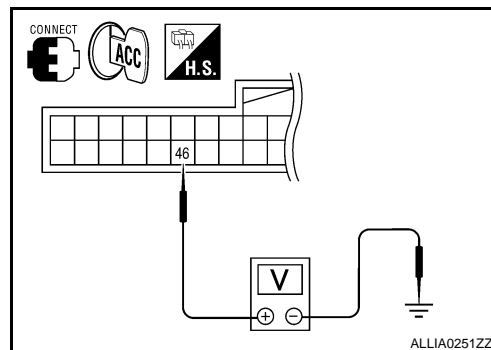

ALLIA0251ZZ

#### 4. CHECK GROUND CIRCUIT

1. Turn ignition switch OFF.
2. Disconnect microphone harness connector R7 and AV control unit harness connector M46.

A  
B  
C  
D  
E  
F  
G  
H  
I  
J  
K  
L  
M  
O  
P

AV

# POWER SUPPLY AND GROUND CIRCUIT (COUPE)

[BOSE AUDIO WITH NAVIGATION]

## < COMPONENT DIAGNOSIS >

3. Check continuity between microphone harness connector R7 (A) terminal 2 and AV control unit harness connector M46 (B) terminal 47.

Signal name	Continuity
Ground	Continuity should exist.

### Does continuity exist?

- YES >> Inspection End.  
NO >> Repair harness or connector.

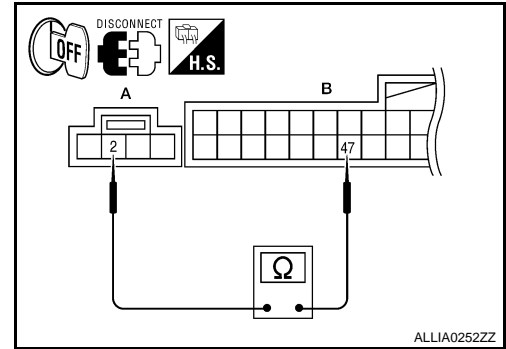

# POWER SUPPLY AND GROUND CIRCUIT (SEDAN)

[BOSE AUDIO WITH NAVIGATION]

< COMPONENT DIAGNOSIS >

## POWER SUPPLY AND GROUND CIRCUIT (SEDAN)

### AV CONTROL UNIT

#### AV CONTROL UNIT : Diagnosis Procedure

INFOID:000000003221737

#### 1. CHECK FUSE

Check that the following fuses of the AV control unit are not blown.

Unit	Terminals	Signal name	Fuse No.
AV control unit	20	Battery power	24
	7	Ignition switch ACC or ON	19
	10	Ignition switch ON or START	3

Are the fuses OK?

YES >> GO TO 2

NO >> Be sure to eliminate cause of malfunction before installing new fuse.

#### 2. CHECK POWER SUPPLY CIRCUIT

Check voltage between AV control unit harness connector and ground.

(+)		(-)	Ignition switch position	Value (Approx.)
Connector	Terminal			
M47	20	Ground	OFF	Battery voltage
	7		ACC	
	10		ON	

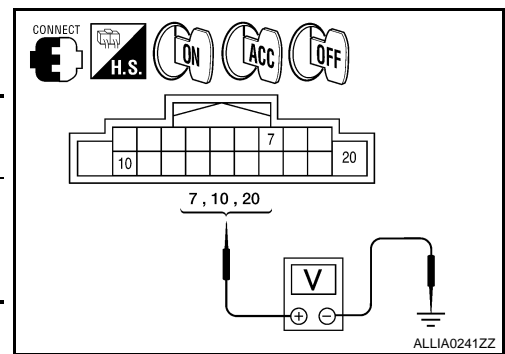

Are the voltage tests as specified?

YES >> GO TO 3

NO >> Check harness between AV control unit and fuse.

#### 3. CHECK GROUND CIRCUIT

1. Turn ignition switch OFF.
2. Disconnect AV control unit connectors.
3. Check continuity between AV control unit harness connector M47 terminal 19 and ground.

Signal name	Continuity
Ground	Continuity should exist.

Does continuity exist?

YES >> Inspection End.

NO >> Repair harness or connector.

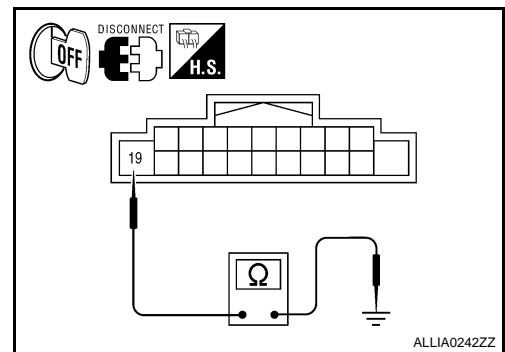

### REAR VIEW CAMERA CONTROL UNIT

#### REAR VIEW CAMERA CONTROL UNIT : Diagnosis Procedure

INFOID:000000003221738

#### 1. CHECK FUSE

Check that the following fuses of the rear view camera control unit are not blown.

Unit	Terminals	Signal name	Fuse No.
Rear view camera control unit	1	Battery power	24
	2	Ignition switch ACC or ON	19

# POWER SUPPLY AND GROUND CIRCUIT (SEDAN)

[BOSE AUDIO WITH NAVIGATION]

## < COMPONENT DIAGNOSIS >

### Are the fuses OK?

YES >> GO TO 2

NO >> Be sure to eliminate cause of malfunction before installing new fuse.

## 2.CHECK POWER SUPPLY CIRCUIT

Check voltage between rear view camera control unit harness connector and ground.

(+)		(-)	Ignition switch position	Value (Approx.)
Connector	Terminal			
B31	1	Ground	OFF	Battery voltage
	2		ACC	

### Are the voltage readings as specified?

YES >> GO TO 3

NO >> Check harness between rear view camera control unit and fuse.

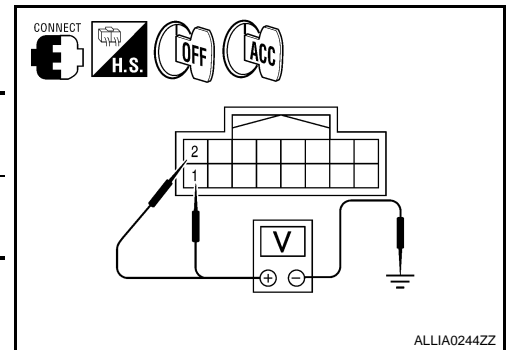

## 3.CHECK GROUND CIRCUIT

1. Turn ignition switch OFF.
2. Disconnect rear view camera control unit connector.
3. Check continuity between rear view camera control unit harness connector B31 terminal 3 and ground.

Signal name	Continuity
Ground	Continuity should exist.

### Does continuity exist?

YES >> Inspection End.

NO >> Repair harness or connector.

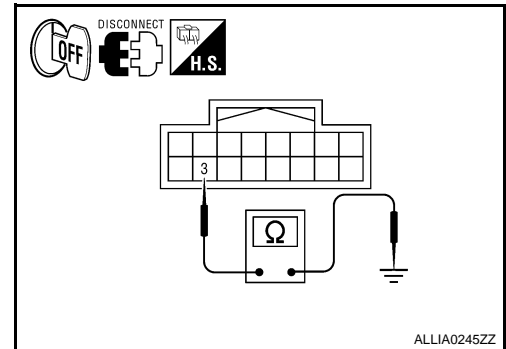

## REAR VIEW CAMERA

### REAR VIEW CAMERA : Diagnosis Procedure

INFOID:000000003214797

## 1.CHECK POWER SUPPLY CIRCUIT (REAR VIEW CAMERA SIDE)

Check voltage between rear view camera harness connector and ground.

Connector	Terminal	Transmission position	Value (Approx.)
B35	1	Reverse	6V

### Is inspection result normal?

YES >> GO TO 4

NO >> GO TO 2

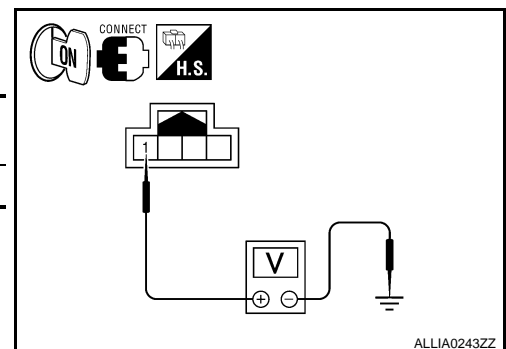

## 2.CHECK POWER SUPPLY CIRCUIT (CONTINUITY)

# POWER SUPPLY AND GROUND CIRCUIT (SEDAN)

[BOSE AUDIO WITH NAVIGATION]

## < COMPONENT DIAGNOSIS >

1. Turn ignition switch OFF.
2. Disconnect rear view camera and rear view camera control unit connectors.
3. Check continuity between rear view camera harness connector B35 (A) terminal 1 and rear view camera control unit harness connector B31 (B) terminal 8.

Signal name	Continuity
Camera ON signal	Continuity should exist.

4. Check continuity between rear view camera harness connector B35 (A) terminal 1 and ground.

Signal name	Continuity
Camera ON signal	Continuity should not exist.

Is inspection result normal?

- YES >> GO TO 3  
 NO >> Repair harness or connector.

### 3.CHECK POWER SUPPLY CIRCUIT (CAMERA CONTROL UNIT SIDE)

1. Connect rear view camera control unit harness connector.
2. Turn ignition switch ON.
3. Check voltage between rear view camera control unit harness connector and ground.

Connector	Terminal	Transmission position	Value (Approx.)
B31	8	Reverse	6V

Is voltage approximately 6V?

- YES >> Inspection End.  
 NO >> Replace rear view camera control unit. Refer to [AV-447](#).  
["Removal and Installation - Sedan"](#).

### 4.CHECK GROUND CIRCUIT

1. Turn ignition switch OFF.
2. Disconnect rear view camera harness connector.
3. Check continuity between rear view camera harness connector B35 terminal 2 and ground.

Signal name	Continuity
Ground	Continuity should exist.

Is inspection result normal?

- YES >> Inspection End.  
 NO >> Repair harness or connector.

## BOSE SPEAKER AMP

### BOSE SPEAKER AMP : Diagnosis Procedure

INFOID:000000003221739

#### 1.CHECK FUSE

Check that the following fuses of the BOSE speaker amp. are not blown.

Unit	Terminals	Signal name	Fuse No.
BOSE speaker amp.	50	Battery power	25
	51		26

A  
B  
C  
D  
E  
F  
G  
H  
I  
J  
K  
L  
M  
AV  
O  
P

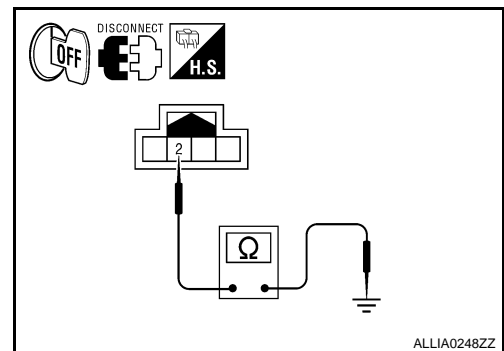
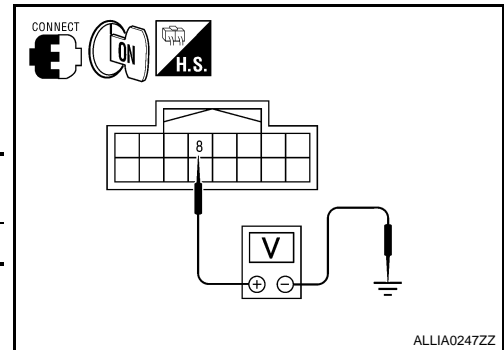
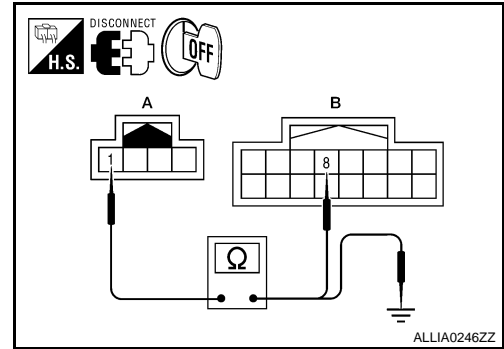

# POWER SUPPLY AND GROUND CIRCUIT (SEDAN)

[BOSE AUDIO WITH NAVIGATION]

## < COMPONENT DIAGNOSIS >

### Are the fuses OK?

YES >> GO TO 2

NO >> Be sure to eliminate cause of malfunction before installing new fuse.

### 2.CHECK POWER SUPPLY CIRCUIT

1. Turn ignition switch OFF.
2. Disconnect BOSE speaker amp connector.
3. Check voltage between BOSE speaker amp harness connector and ground.

(+)		(-)	Voltage (approx.)
Connector	Terminal		
B122	50	Ground	Battery voltage
	51		

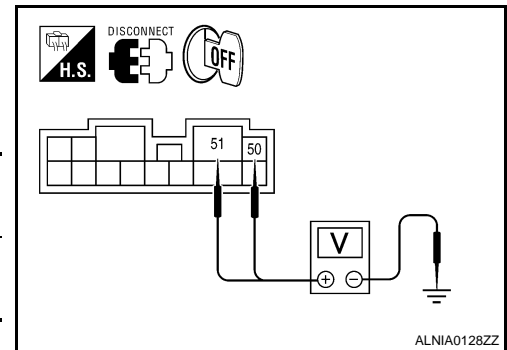

### Are the voltage readings as specified?

YES >> GO TO 3

NO >> Check harness between BOSE speaker amp. and fuse.

### 3.CHECK GROUND CIRCUIT

1. Turn ignition switch OFF.
2. Disconnect BOSE speaker amp connector.
3. Check continuity between BOSE speaker amp harness connector and ground.

Connector	Terminal	—	Continuity
B122	47	Ground	Yes
	52		

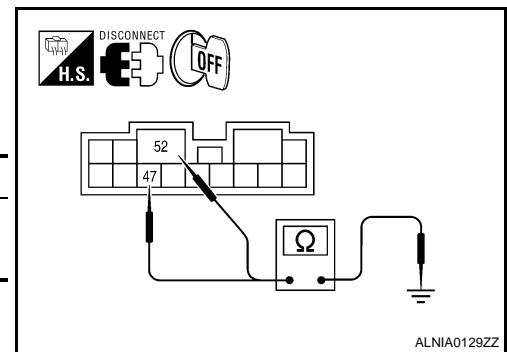

### Are continuity test results as specified?

YES >> Inspection End.

NO >> Repair harness or connector.

## CD CHANGER

### CD CHANGER : Diagnosis Procedure

INFOID:000000003221740

### 1.CHECK FUSE

Check that the following fuses of the CD changer are not blown.

Unit	Terminals	Signal name	Fuse No.
CD changer	12	Battery power	24
	16	Ignition switch ACC or ON	19

### Are the fuses OK?

YES >> GO TO 2

NO >> Be sure to eliminate cause of malfunction before installing new fuse.

### 2.CHECK POWER SUPPLY CIRCUIT



# POWER SUPPLY AND GROUND CIRCUIT (SEDAN)

[BOSE AUDIO WITH NAVIGATION]

## < COMPONENT DIAGNOSIS >

Check voltage between CD changer harness connector and ground.

(+)		(-)	Ignition switch position	Value (Approx.)
Connector	Terminal			
M42	12	Ground	OFF	Battery voltage
	16		ACC	

Are the voltage readings as specified?

- YES >> Inspection End.
- NO >> Check harness between CD changer and fuse.

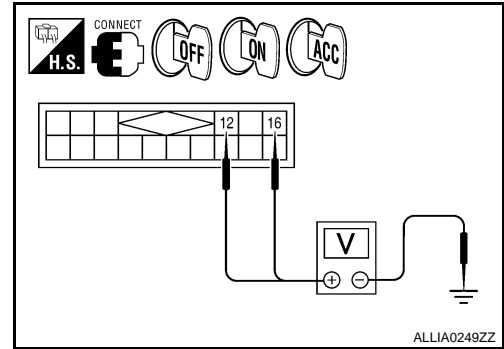

## MICROPHONE

### MICROPHONE : Diagnosis Procedure

INFOID:000000003221741

#### 1. CHECK POWER SUPPLY CIRCUIT (MICROPHONE SIDE)

Check voltage between microphone harness connector and ground.

(+)		(-)	Ignition switch position	Value (Approx.)
Connector	Terminal			
R7	4	Ground	ON	5V

Is proper voltage present?

- YES >> GO TO 4
- NO >> GO TO 2

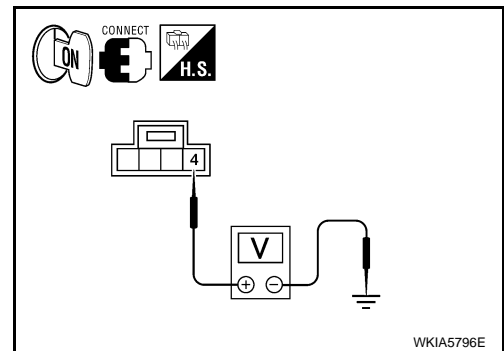

#### 2. CHECK POWER SUPPLY CIRCUIT (CONTINUITY)

1. Turn ignition switch OFF.
2. Disconnect microphone and AV control unit harness connectors.
3. Check continuity between microphone harness connector R7 (A) terminal 4 and AV control unit harness connector M46 (B) terminal 46.

Signal name	Continuity
Microphone VCC signal	Continuity should exist.

4. Check continuity between microphone harness connector R7 (A) terminal 4 and ground.

Signal name	Continuity
Microphone VCC signal	Continuity should not exist.

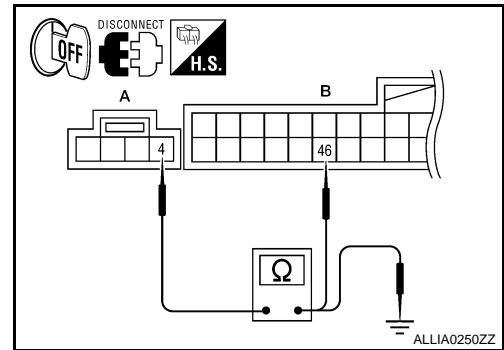

Are the continuity test results as specified?

- YES >> GO TO 3
- NO >> Repair harness or connector.

#### 3. CHECK POWER SUPPLY CIRCUIT (AV CONTROL UNIT SIDE)

1. Connect AV control unit harness connector.
2. Turn ignition switch to ACC.

A  
B  
C  
D  
E  
F  
G  
H  
I  
J  
K  
L  
M  
N  
O  
P

AV

# POWER SUPPLY AND GROUND CIRCUIT (SEDAN)

[BOSE AUDIO WITH NAVIGATION]

## < COMPONENT DIAGNOSIS >

3. Check voltage between AV control unit harness connector and ground.

(+)		(-)	Ignition switch position	Value (Approx.)
Connector	Terminal			
M46	46	Ground	ACC	5V

Is voltage approximately 5 volts?

- YES >> Inspection End.  
 NO >> Replace AV control unit. Refer to [AV-422. "Removal and Installation"](#).

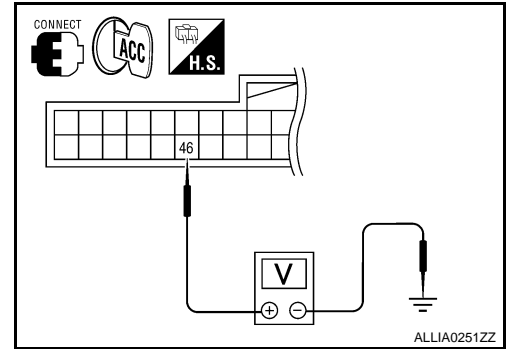

## 4. CHECK GROUND CIRCUIT

1. Turn ignition switch OFF.
2. Disconnect microphone harness connector R7 and AV control unit harness connector M46.
3. Check continuity between microphone harness connector R7 (A) terminal 2 and AV control unit harness connector M46 (B) terminal 47.

Signal name	Continuity
Ground	Continuity should exist.

Does continuity exist?

- YES >> Inspection End.  
 NO >> Repair harness or connector.

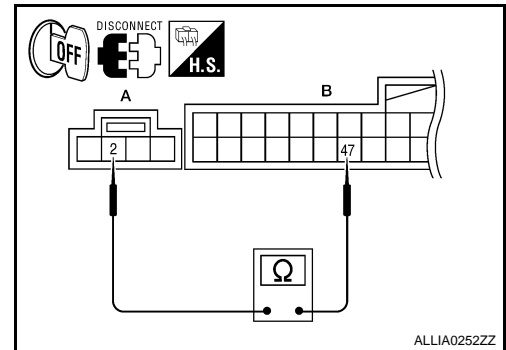

# DOOR SPEAKER (COUPE)

< COMPONENT DIAGNOSIS >

[BOSE AUDIO WITH NAVIGATION]

## DOOR SPEAKER (COUPE)

### Description

INFOID:000000001830544

The audio unit sends audio signals to the BOSE speaker amp. The BOSE speaker amp. amplifies the audio signals before sending them to the door speakers using the audio signal circuits.

### Diagnosis Procedure

INFOID:000000001830545

#### 1. HARNESS CHECK

1. Disconnect BOSE speaker amp. connector B121 and suspect speaker connector.
2. Check continuity between BOSE speaker amp. harness connector B121 (A) and suspect speaker harness connector (B).

A		B		Continuity
Connector	Terminal	Connector	Terminal	
B121	58	D3	1	Yes
	59		2	
	71	D103	1	
	72		2	

3. Check continuity between BOSE speaker amp. harness connector B121 (A) and ground.

A		—	Continuity
Connector	Terminal		
B121	58	Ground	No
	59		
	71		
	72		

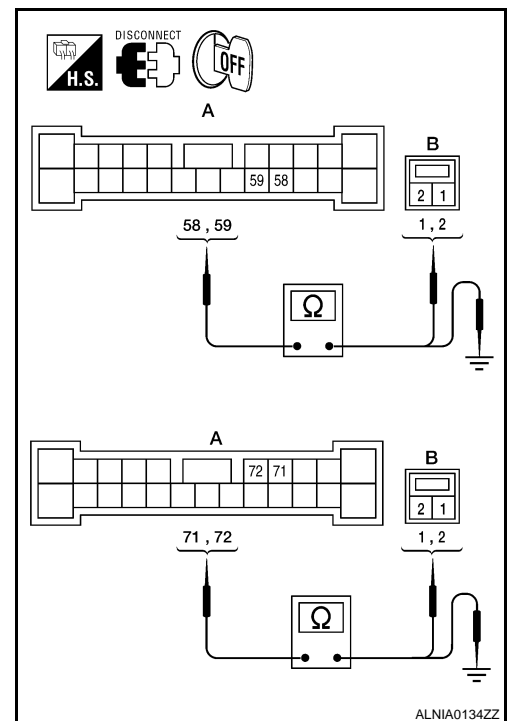

Are continuity test results as specified?

YES >> GO TO 2

- NO >> • Check connector housings for disconnected or loose terminals.  
• Repair harness or connector.

#### 2. DOOR SPEAKER SIGNAL CHECK

A  
B  
C  
D  
E  
F  
G  
H  
I  
J  
K  
L  
M

AV

O  
P

# DOOR SPEAKER (COUPE)

[BOSE AUDIO WITH NAVIGATION]

## < COMPONENT DIAGNOSIS >

1. Connect BOSE speaker amp. connector B121 and suspect speaker connector.
2. Turn ignition switch to ACC.
3. Push "POWER" switch.
4. Check the signal between BOSE speaker amp. harness connector B121 terminals with CONSULT-III or oscilloscope.

Connector	Terminal		Condition	Reference signal
	(+)	(-)		
B121	58	59	Receive audio signal	
	71	72		

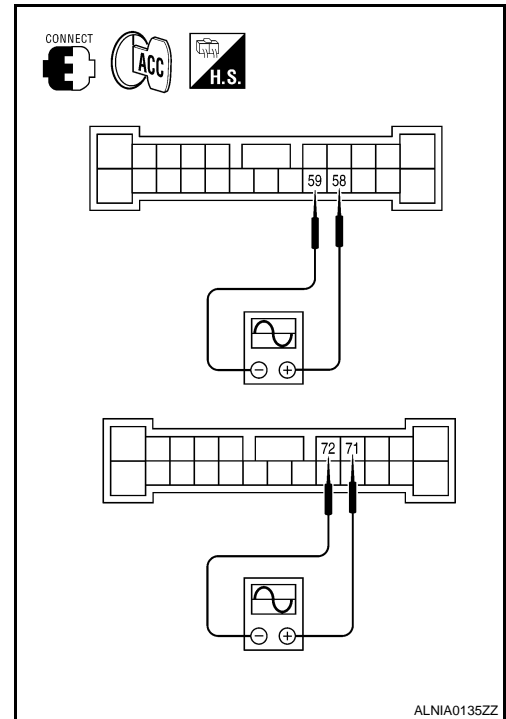

Is audio signal voltage as specified?

YES >> Replace suspect speaker. Refer to [AV-427. "Removal and Installation"](#).

NO >> GO TO 3

## 3. HARNESS CHECK

1. Disconnect AV control unit connector M47 and BOSE speaker amp. connector B121.
2. Check continuity between audio unit harness connector M47 (A) and BOSE speaker amp. harness connector B121 (B).

A		B		Continuity
Connector	Terminal	Connector	Terminal	
M47	2	B121	75	Yes
	3		76	
	11		73	
	12		74	

3. Check continuity between AV control unit harness connector M47 (A) and ground.

A		—	Continuity
Connector	Terminal		
M47	2	Ground	No
	3		
	11		
	12		

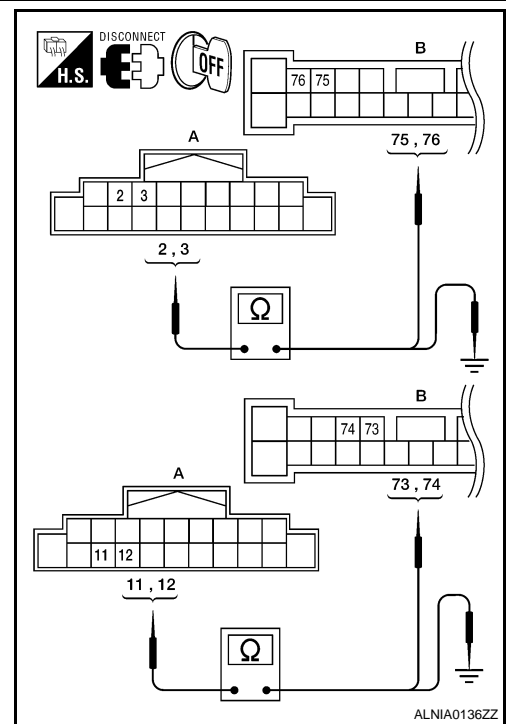

Are continuity test results as specified?

YES >> GO TO 4

NO >> • Check connector housings for disconnected or loose terminals.  
• Repair harness or connector.

## 4. DOOR SPEAKER SIGNAL CHECK

# DOOR SPEAKER (COUPE)

[BOSE AUDIO WITH NAVIGATION]

## < COMPONENT DIAGNOSIS >

1. Connect AV control unit connector and BOSE speaker amp. connector.
2. Turn ignition switch to ACC.
3. Push "POWER" switch.
4. Check the signal between AV control unit harness connector terminals with CONSULT-III or oscilloscope.

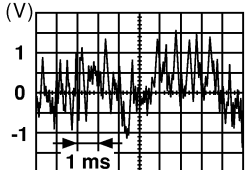
Connector	Terminals		Condition	Reference signal
	(+)	(-)		
M47	2	3	Receive audio signal	
	11	12		

SKIA0177E

Are the audio signal voltage readings as specified?

- YES >> Replace BOSE speaker amp. Refer to [AV-423, "Removal and Installation - Coupe"](#).
- NO >> Replace AV control unit. Refer to [AV-422, "Removal and Installation"](#).

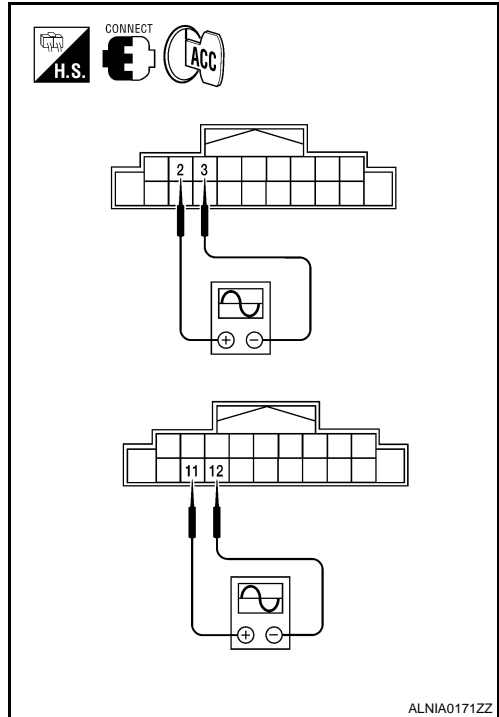

A  
B  
C  
D  
E  
F  
G  
H  
I  
J  
K  
L  
M  
O  
P

AV

# FRONT DOOR SPEAKER (SEDAN)

< COMPONENT DIAGNOSIS >

[BOSE AUDIO WITH NAVIGATION]

## FRONT DOOR SPEAKER (SEDAN)

### Description

INFOID:000000003214803

The audio unit sends audio signals to the BOSE speaker amp. The BOSE speaker amp. amplifies the audio signals before sending them to the front door speakers using the audio signal circuits.

### Diagnosis Procedure

INFOID:000000003214804

#### 1. HARNESS CHECK

1. Disconnect BOSE speaker amp. connector B121 and suspect speaker connector.
2. Check continuity between BOSE speaker amp. harness connector B121 (A) and suspect speaker harness connector (B).

A		B		Continuity
Connector	Terminal	Connector	Terminal	
B121	58	D3	1	Yes
	59		2	
	71	D103	1	
	72		2	

3. Check continuity between BOSE speaker amp. harness connector B121 (A) and ground.

A		—	Continuity
Connector	Terminal		
B121	58	Ground	No
	59		
	71		
	72		

Are continuity test results as specified?

YES >> GO TO 2

- NO >> • Check connector housings for disconnected or loose terminals.  
• Repair harness or connector.

#### 2. FRONT DOOR SPEAKER SIGNAL CHECK

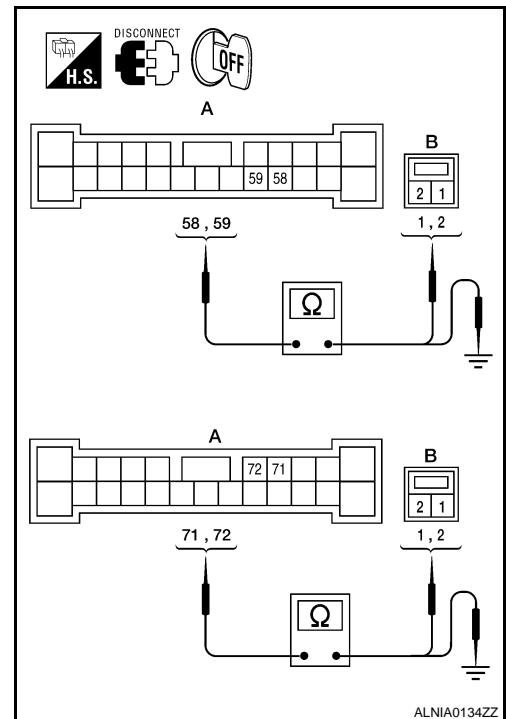

ALNIA0134ZZ

# FRONT DOOR SPEAKER (SEDAN)

[BOSE AUDIO WITH NAVIGATION]

## < COMPONENT DIAGNOSIS >

1. Connect BOSE speaker amp. connector B121 and suspect speaker connector.
2. Turn ignition switch to ACC.
3. Push "POWER" switch.
4. Check the signal between BOSE speaker amp. harness connector B121 terminals with CONSULT-III or oscilloscope.

Connector	Terminal		Condition	Reference signal
	(+)	(-)		
B121	58	59	Receive audio signal	
	71	72		

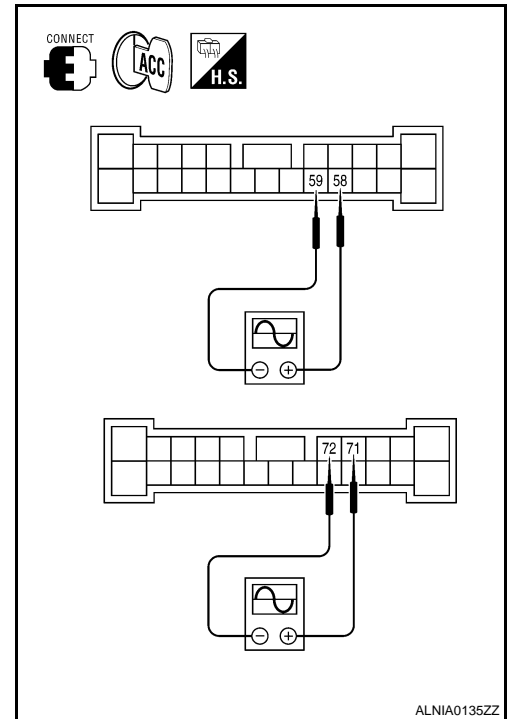

Is audio signal voltage as specified?

YES >> Replace suspect speaker. Refer to [AV-427. "Removal and Installation"](#).

NO >> GO TO 3

## 3. HARNESS CHECK

1. Disconnect AV control unit connector M47 and BOSE speaker amp. connector B121.
2. Check continuity between audio unit harness connector M47 (A) and BOSE speaker amp. harness connector B121 (B).

A		B		Continuity
Connector	Terminal	Connector	Terminal	
M47	2	B121	75	Yes
	3		76	
	11		73	
	12		74	

3. Check continuity between AV control unit harness connector M47 (A) and ground.

A		—	Continuity
Connector	Terminal		
M47	2	Ground	No
	3		
	11		
	12		

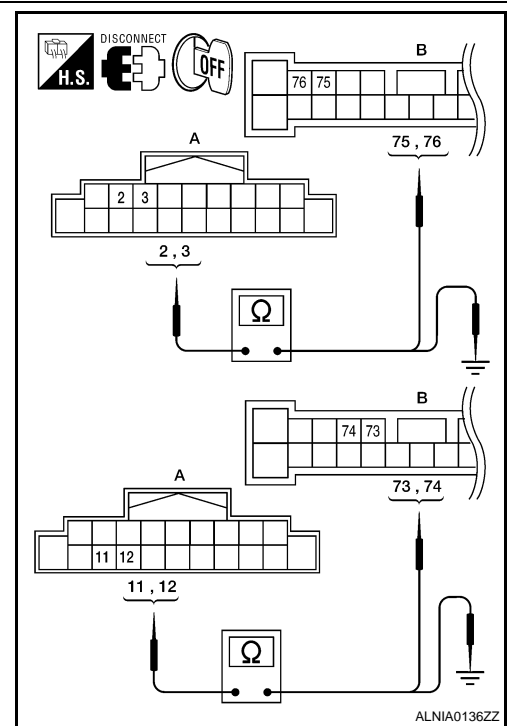

Are continuity test results as specified?

YES >> GO TO 4

NO >> • Check connector housings for disconnected or loose terminals.  
• Repair harness or connector.

## 4. FRONT DOOR SPEAKER SIGNAL CHECK

A  
B  
C  
D  
E  
F  
G  
H  
I  
J  
K  
L  
M  
O  
P

AV

# FRONT DOOR SPEAKER (SEDAN)

[BOSE AUDIO WITH NAVIGATION]

## < COMPONENT DIAGNOSIS >

1. Connect AV control unit connector and BOSE speaker amp. connector.
2. Turn ignition switch to ACC.
3. Push "POWER" switch.
4. Check the signal between AV control unit harness connector terminals with CONSULT-III or oscilloscope.

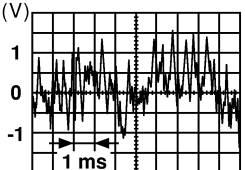
Connector	Terminals		Condition	Reference signal
	(+)	(-)		
M47	2	3	Receive audio signal	
	11	12		

SKIA0177E

Are the audio signal voltage readings as specified?

- YES >> Replace BOSE speaker amp. Refer to [AV-423, "Removal and Installation - Sedan"](#).
- NO >> Replace AV control unit. Refer to [AV-422, "Removal and Installation"](#).

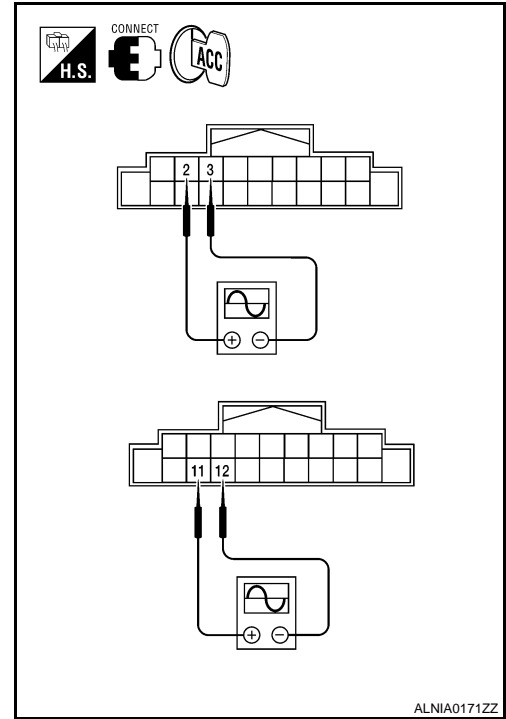

ALNIA0171ZZ



# FRONT TWEETER (COUPE)

< COMPONENT DIAGNOSIS >

[BOSE AUDIO WITH NAVIGATION]

## FRONT TWEETER (COUPE)

### Description

INFOID:000000001830546

The audio unit sends audio signals to the BOSE speaker amp. The BOSE speaker amp. amplifies the audio signals before sending them to the front tweeters using the audio signal circuits.

### Diagnosis Procedure

INFOID:000000001830547

#### 1. HARNESS CHECK

1. Disconnect BOSE speaker amp. connector B122 and suspect tweeter connector.
2. Check continuity between BOSE speaker amp. harness connector B122 (A) and suspect tweeter harness connector (B).

A		B		Continuity
Connector	Terminal	Connector	Terminal	
B122	41	M51	1	Yes
	42		2	
	44	M52	1	
	43		2	

3. Check continuity between BOSE speaker amp. harness connector B122 (A) and ground.

A		—	Continuity
Connector	Terminal		
B122	41	Ground	No
	42		
	44		
	43		

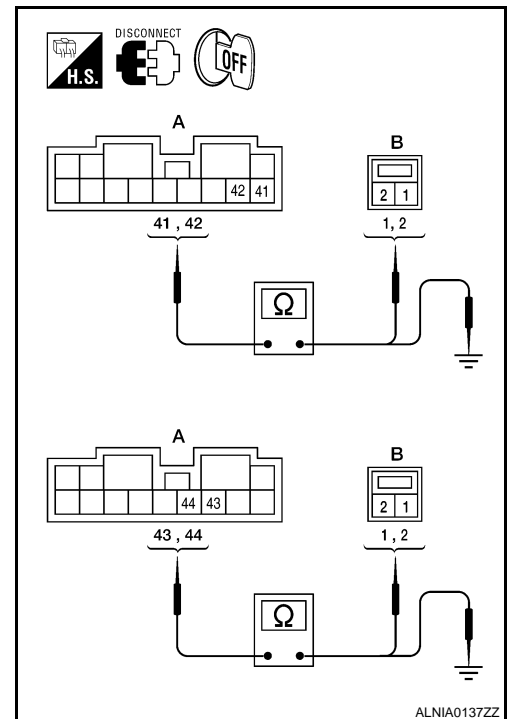

Are continuity test results as specified?

YES >> GO TO 2

- NO >> • Check connector housings for disconnected or loose terminals.  
• Repair harness or connector.

#### 2. FRONT TWEETER SIGNAL CHECK

A  
B  
C  
D  
E  
F  
G  
H  
I  
J  
K  
L  
M  
O  
P

# FRONT TWEETER (COUPE)

[BOSE AUDIO WITH NAVIGATION]

## < COMPONENT DIAGNOSIS >

1. Connect BOSE speaker amp. connector B122 and suspect tweeter connector.
2. Turn ignition switch to ACC.
3. Push "POWER" switch.
4. Check the signal between BOSE speaker amp. harness connector B122 terminals with CONSULT-III or oscilloscope.

Connector	Terminals		Condition	Reference signal
	(+)	(-)		
B122	41	42	Receive audio signal	
	44	43		

SKIA0177E

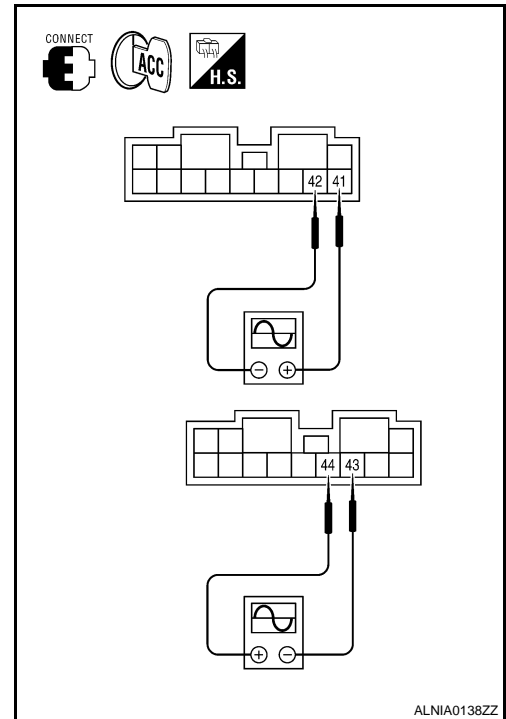

Are voltage readings as specified?

YES >> Replace suspect tweeter. Refer to [AV-425, "Removal and Installation"](#).

NO >> GO TO 3

## 3. HARNESS CHECK

1. Disconnect AV control unit connector M47 and BOSE speaker amp. connector B121.
2. Check continuity between AV control unit harness connector (A) M47 and BOSE speaker amp. harness connector B121 (B).

A		B		Continuity
Connector	Terminal	Connector	Terminal	
M47	2	B121	75	Yes
	3		76	
	11		73	
	12		74	

3. Check continuity between AV control unit harness connector B121 (A) and ground.

A		—	Continuity
Connector	Terminal		
M47	2	Ground	No
	3		
	11		
	12		

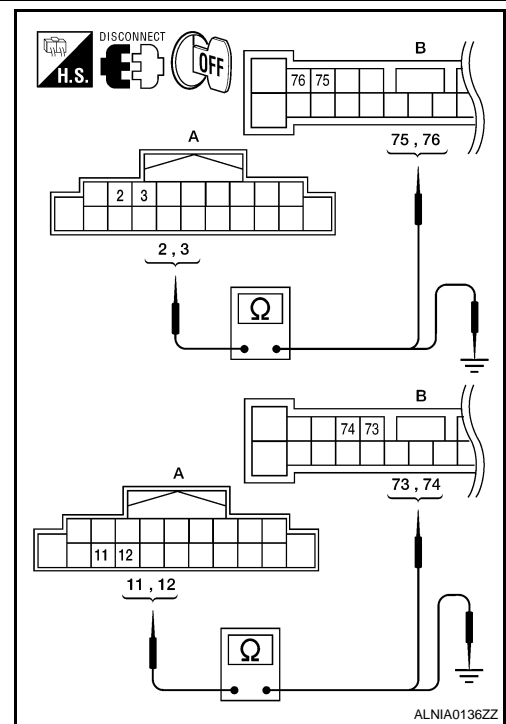

Are continuity test results as specified?

YES >> GO TO 4

NO >> • Check connector housings for disconnected or loose terminals.  
• Repair harness or connector.

## 4. FRONT TWEETER SIGNAL CHECK

# FRONT TWEETER (COUPE)

[BOSE AUDIO WITH NAVIGATION]

## < COMPONENT DIAGNOSIS >

1. Connect AV control unit connector and BOSE speaker amp. connector.
2. Turn ignition switch to ACC.
3. Push "POWER" switch.
4. Check the signal between AV control unit harness connector terminals with CONSULT-III or oscilloscope.

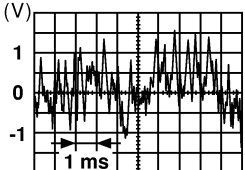
Connector	Terminals		Condition	Reference signal
	(+)	(-)		
M47	2	3	Receive audio signal	
	11	12		

SKIA0177E

Are voltage readings as specified?

- YES >> Replace BOSE speaker amp. Refer to [AV-423, "Removal and Installation - Coupe"](#).
- NO >> Replace AV control unit. Refer to [AV-422, "Removal and Installation"](#).

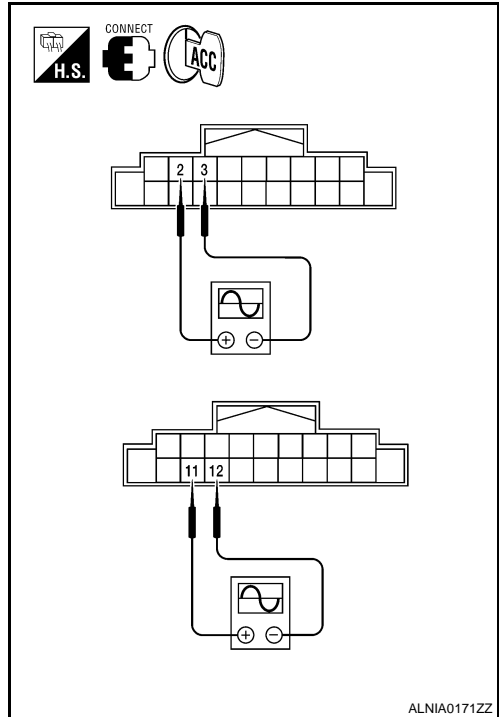

A  
B  
C  
D  
E  
F  
G  
H  
I  
J  
K  
L  
M  
O  
P

AV

# TWEETER (SEDAN)

< COMPONENT DIAGNOSIS >

[BOSE AUDIO WITH NAVIGATION]

## TWEETER (SEDAN)

### Description

INFOID:000000003214805

The audio unit sends audio signals to the BOSE speaker amp. The BOSE speaker amp. amplifies the audio signals before sending them to the tweeters using the audio signal circuits.

### Diagnosis Procedure

INFOID:000000003214806

#### 1. HARNESS CHECK

1. Disconnect BOSE speaker amp. connector B122 and suspect tweeter connector.
2. Check continuity between BOSE speaker amp. harness connector B122 (A) and suspect tweeter harness connector (B).

Terminals				Continuity
A		B		
Connector	Terminal	Connector	Terminal	
B122	41	M51	1	Yes
	42		2	
	44	M52	1	
	43		2	

3. Check continuity between BOSE speaker amp. harness connector B122 (A) and ground.

Terminals			Continuity
A		—	
Connector	Terminal		
B122	41	Ground	No
	42		
	44		
	43		

Are continuity test results as specified?

- YES >> GO TO 2  
 NO >> • Check connector housings for disconnected or loose terminals.  
 • Repair harness or connector.

#### 2. TWEETER SIGNAL CHECK

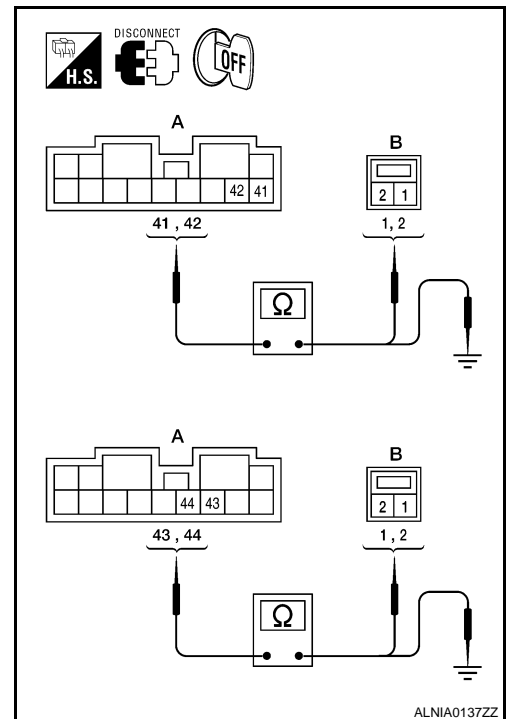

ALNIA0137ZZ

# TWEETER (SEDAN)

[BOSE AUDIO WITH NAVIGATION]

## < COMPONENT DIAGNOSIS >

1. Connect BOSE speaker amp. connector B122 and suspect tweeter connector.
2. Turn ignition switch to ACC.
3. Push "POWER" switch.
4. Check the signal between BOSE speaker amp. harness connector B122 terminals with CONSULT-III or oscilloscope.

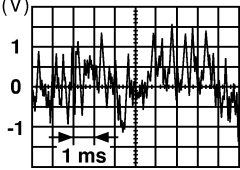
Connector	Terminals		Condition	Reference signal
	(+)	(-)		
B122	41	42	Receive audio signal	
	44	43		

SKIA0177E

Are voltage readings as specified?

YES >> Replace suspect tweeter. Refer to [AV-425, "Removal and Installation"](#).

NO >> GO TO 3

## 3. HARNESS CHECK

1. Disconnect AV control unit connector M47 and BOSE speaker amp. connector B121.
2. Check continuity between AV control unit harness connector (A) M47 and BOSE speaker amp. harness connector B121 (B).

Terminals				Continuity
A		B		
Connector	Terminal	Connector	Terminal	
M47	2	B121	75	Yes
	3		76	
	11		73	
	12		74	

3. Check continuity between AV control unit harness connector B121 (A) and ground.

Terminals			Continuity
A			
Connector	Terminal		
M47	2	Ground	No
	3		
	11		
	12		

Are continuity test results as specified?

YES >> GO TO 4

- NO >>
- Check connector housings for disconnected or loose terminals.
  - Repair harness or connector.

## 4. TWEETER SIGNAL CHECK

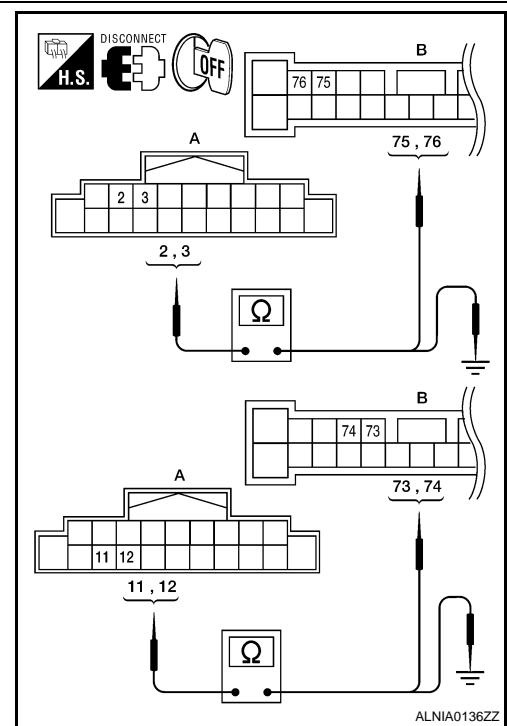
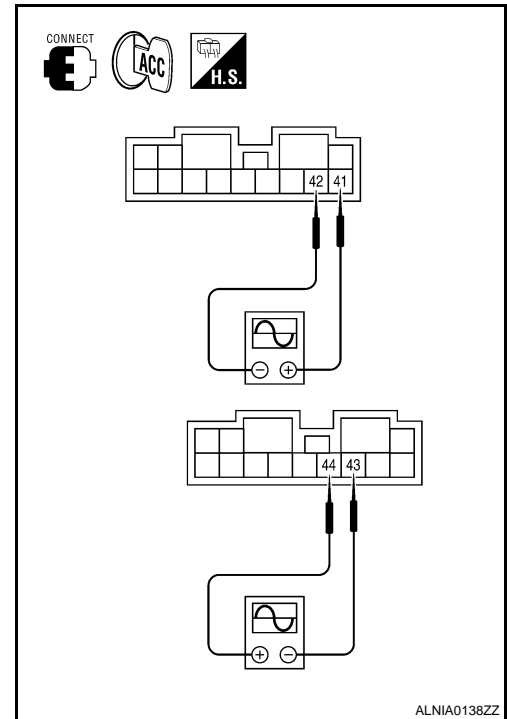

A  
B  
C  
D  
E  
F  
G  
H  
I  
J  
K  
L  
M  
N  
O  
P

AV

## TWEETER (SEDAN)

[BOSE AUDIO WITH NAVIGATION]

### < COMPONENT DIAGNOSIS >

1. Connect AV control unit connector and BOSE speaker amp. connector.
2. Turn ignition switch to ACC.
3. Push "POWER" switch.
4. Check the signal between AV control unit harness connector terminals with CONSULT-III or oscilloscope.

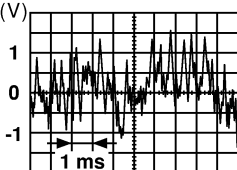
Connector	Terminals		Condition	Reference signal
	(+)	(-)		
M47	2	3	Receive audio signal	
	11	12		

SKIA0177E

### Are voltage readings as specified?

- YES >> Replace BOSE speaker amp. Refer to [AV-423, "Removal and Installation - Sedan"](#).
- NO >> Replace AV control unit. Refer to [AV-422, "Removal and Installation"](#).

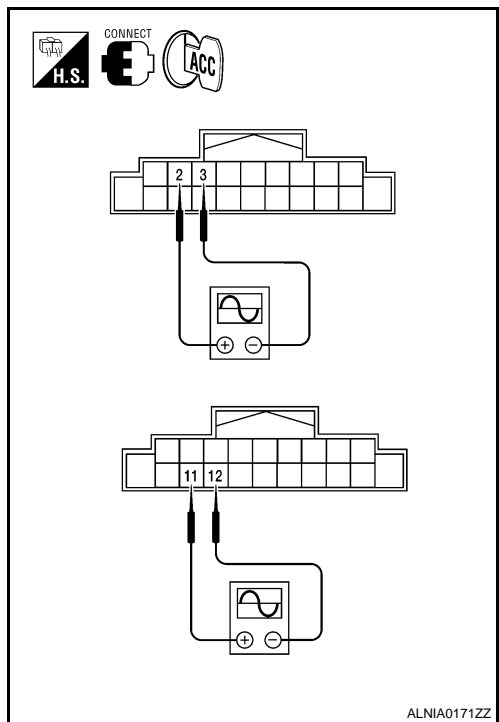

# CENTER SPEAKER

< COMPONENT DIAGNOSIS >

[BOSE AUDIO WITH NAVIGATION]

## CENTER SPEAKER

### Description

INFOID:000000001830548

The audio unit sends audio signals to the BOSE speaker amp. The BOSE speaker amp. amplifies the audio signals before sending them to the center speaker using the audio signal circuits.

### Diagnosis Procedure

INFOID:000000001830549

#### 1. HARNESS CHECK

1. Disconnect BOSE speaker amp. connector B121 and center speaker connector M151.
2. Check continuity between BOSE speaker amp. harness connector B121 (A) and center speaker harness connector M151 (B).

A		B		Continuity
Connector	Terminal	Connector	Terminal	
B121	69	M151	1	Yes
	70		2	

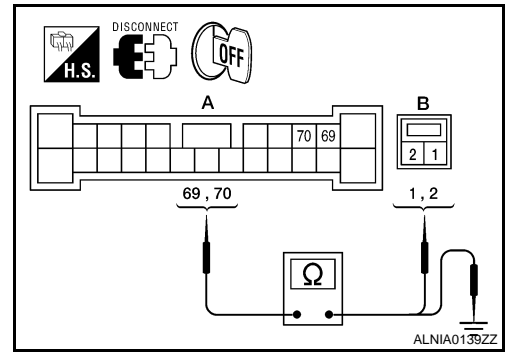

3. Check continuity between BOSE speaker amp. harness connector B121 (A) and ground.

A		—	Continuity
Connector	Terminal		
B121	69	Ground	No
	70		

Are continuity test results as specified?

- YES >> GO TO 2  
 NO >> • Check connector housings for disconnected or loose terminals.  
 • Repair harness or connector.

#### 2. CENTER SPEAKER SIGNAL CHECK

1. Connect BOSE speaker amp. connector B121 and center speaker connector M151.
2. Turn ignition switch to ACC.
3. Push "POWER" switch.
4. Check the signal between BOSE speaker amp. harness connector B121 terminals with CONSULT-III or oscilloscope.

Connector	Terminals		Condition	Reference signal
	(+)	(-)		
B121	69	70	Receive audio signal	

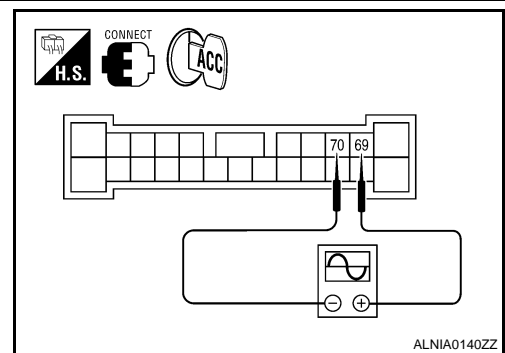

Is the audio signal voltage as specified?

- YES >> Replace center speaker. Refer to [AV-426. "Removal and Installation"](#).  
 NO >> GO TO 3

#### 3. HARNESS CHECK

# CENTER SPEAKER

## < COMPONENT DIAGNOSIS >

## [BOSE AUDIO WITH NAVIGATION]

1. Disconnect AV control unit connector M47 and BOSE speaker amp. connector B121.
2. Check continuity between audio unit harness connector M47 (A) and BOSE speaker amp. harness connector B121 (B).

A		B		Continuity
Connector	Terminal	Connector	Terminal	
M47	2	B121	75	Yes
	3		76	
	11		73	
	12		74	

3. Check continuity between AV control unit harness connector M47 (A) and ground.

A		—	Continuity
Connector	Terminal		
M47	2	Ground	No
	3		
	11		
	12		

Are continuity test results as specified?

YES >> GO TO 4

NO >> • Check connector housings for disconnected or loose terminals.  
• Repair harness or connector.

## 4. CENTER SPEAKER SIGNAL CHECK

1. Connect AV control unit connector and BOSE speaker amp. connector.
2. Turn ignition switch to ACC.
3. Push "POWER" switch.
4. Check the signal between audio unit harness connector M47 terminals with CONSULT-III or oscilloscope.

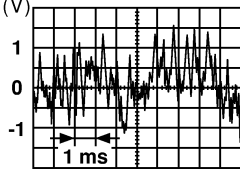
Connector	Terminals		Condition	Reference signal
	(+)	(-)		
M47	2	3	Receive audio signal	
	11	12		

Is the audio signal voltage reading as specified?

YES >> Replace BOSE speaker amp. For coupe, refer to [AV-423, "Removal and Installation - Coupe"](#). For sedan, refer to [AV-423, "Removal and Installation - Sedan"](#).

NO >> Replace AV control unit. Refer to [AV-422, "Removal and Installation"](#).

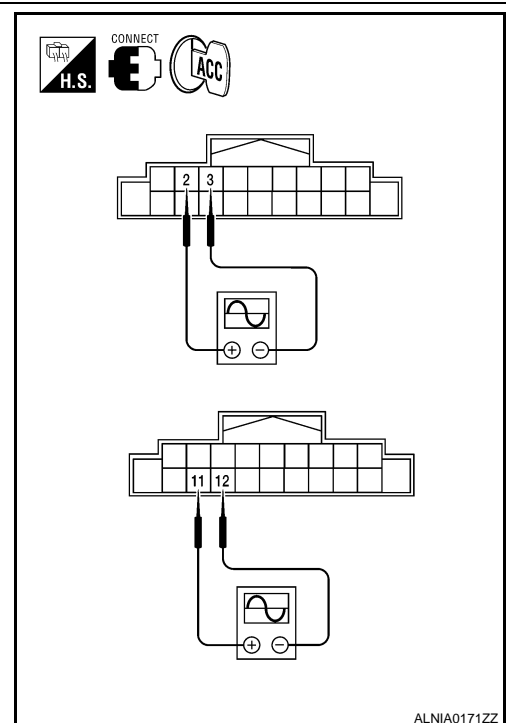
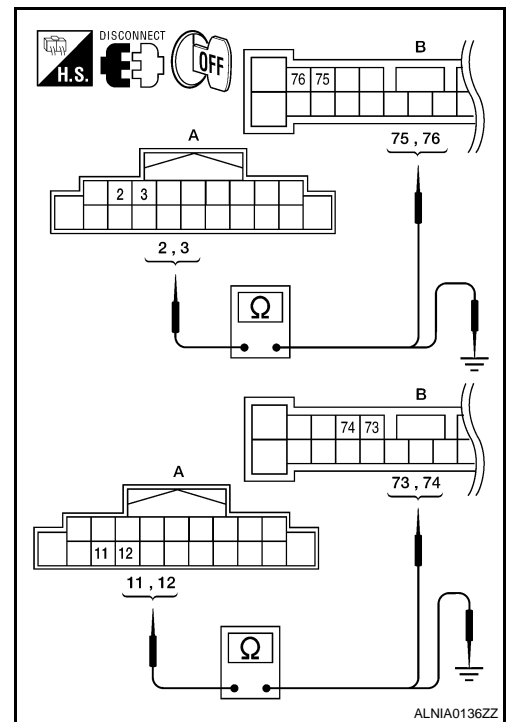



# REAR TWEETER (COUPE)

< COMPONENT DIAGNOSIS >

[BOSE AUDIO WITH NAVIGATION]

## REAR TWEETER (COUPE)

### Description

INFOID:000000001830550

The audio unit sends audio signals to the BOSE speaker amp. The BOSE speaker amp. amplifies the audio signals before sending them to the rear tweeters using the audio signal circuits.

### Diagnosis Procedure

INFOID:000000001830551

#### 1. HARNESS CHECK

1. Disconnect BOSE speaker amp. connectors B121, B122 and suspect tweeter connector.
2. Check continuity between BOSE speaker amp. harness connectors B121 (A) and B122 (B) and suspect tweeter harness connector (C).

Connector	Terminal	Connector	Terminal	Continuity
A: B121	55	C: D202	2	Yes
	68		1	
B: B122	49	C: D302	2	
	54		1	

3. Check continuity between BOSE speaker amp. harness connectors B121 (A) and B122 (B) and ground.

Connector	Terminal	—	Continuity
A: B121	68	Ground	No
	55		
B: B122	49		
	54		

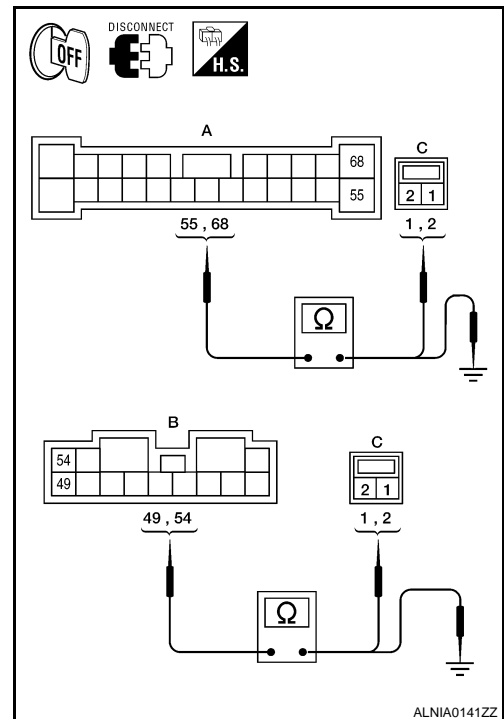

ALNIA0141ZZ

Are the continuity test results as specified?

YES >> GO TO 2

- NO >> • Check connector housings for disconnected or loose terminals.  
• Repair harness or connector.

#### 2. REAR TWEETER SIGNAL CHECK

A  
B  
C  
D  
E  
F  
G  
H  
I  
J  
K  
L  
M  
O  
P

# REAR TWEETER (COUPE)

[BOSE AUDIO WITH NAVIGATION]

## < COMPONENT DIAGNOSIS >

1. Connect BOSE speaker amp. connectors B121, B122 and suspect tweeter connector.
2. Turn ignition switch to ACC.
3. Push "POWER" switch.
4. Check the signal between BOSE speaker amp. harness connectors (A) B121 and (B) B122 terminals with CONSULT-III or oscilloscope.

Connector	Terminals		Condition	Reference signal
	(+)	(-)		
A: B121	68	55	Receive audio signal	
B: B122	54	49		

SKIA0177E

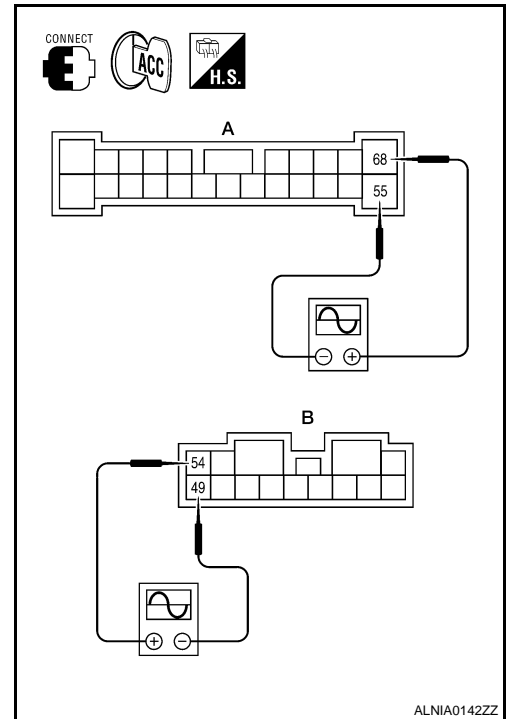

Is the audio signal voltage readings as specified?

- YES >> Replace suspect tweeter. Refer to [AV-429. "Removal and Installation - Coupe"](#).
- NO >> GO TO 3.

### 3. HARNESS CHECK

1. Disconnect AV control unit connector M47 and BOSE speaker amp. connector B121.
2. Check continuity between AV control unit harness connector M47 (A) and BOSE speaker amp. harness connector B121 (B).

A		B		Continuity
Connector	Terminal	Connector	Terminal	
M47	5	B121	64	Yes
	6		63	
	14		66	
	15		65	

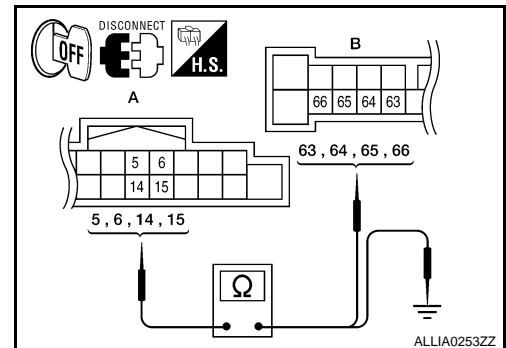

3. Check continuity between AV control unit harness connector M47 (A) and ground.

A		—	Continuity
Connector	Terminal		
M47	5	Ground	No
	6		
	14		
	15		

Are continuity test results as specified?

- YES >> GO TO 4
- NO >> • Check connector housings for disconnected or loose terminals.  
• Repair harness or connector.

### 4. REAR TWEETER SIGNAL CHECK

# REAR TWEETER (COUPE)

## < COMPONENT DIAGNOSIS >

## [BOSE AUDIO WITH NAVIGATION]

1. Connect AV control unit connector M47 and BOSE speaker amp. connector B121.
2. Turn ignition switch to ACC.
3. Push "POWER" switch.
4. Check the signal between AV control unit harness connector M47 terminals with CONSULT-III or oscilloscope.

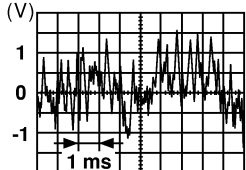
Connector	Terminals		Condition	Reference signal
	(+)	(-)		
M47	5	6	Receive audio signal	 <small>SKIA0177E</small>
	14	15		

Are the audio signal voltage readings as specified?

- YES >> Replace BOSE speaker amp. Refer to [AV-423, "Removal and Installation - Coupe"](#).
- NO >> Replace AV control unit. Refer to [AV-422, "Removal and Installation"](#).

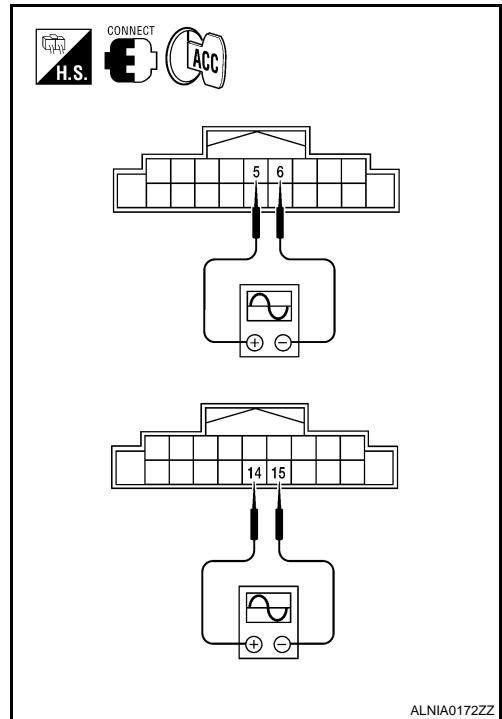

A  
B  
C  
D  
E  
F  
G  
H  
I  
J  
K  
L  
M  
O  
P

AV

# REAR DOOR SPEAKER (SEDAN)

< COMPONENT DIAGNOSIS >

[BOSE AUDIO WITH NAVIGATION]

## REAR DOOR SPEAKER (SEDAN)

### Description

INFOID:000000003214807

The audio unit sends audio signals to the BOSE speaker amp. The BOSE speaker amp. amplifies the audio signals before sending them to the rear door speakers using the audio signal circuits.

### Diagnosis Procedure

INFOID:000000003214808

#### 1. HARNESS CHECK

1. Disconnect BOSE speaker amp. connectors B121, B122 and suspect speaker connector.
2. Check continuity between BOSE speaker amp. harness connectors B121 (A) and B122 (B) and suspect speaker harness connector (C).

Connector	Terminal	Connector	Terminal	Continuity
A: B121	55	C: D202	2	Yes
	68		1	
B: B122	49	C: D302	2	
	54		1	

3. Check continuity between BOSE speaker amp. harness connectors B121 (A) and B122 (B) and ground.

Connector	Terminal	—	Continuity
A: B121	68	Ground	No
	55		
B: B122	49		
	54		

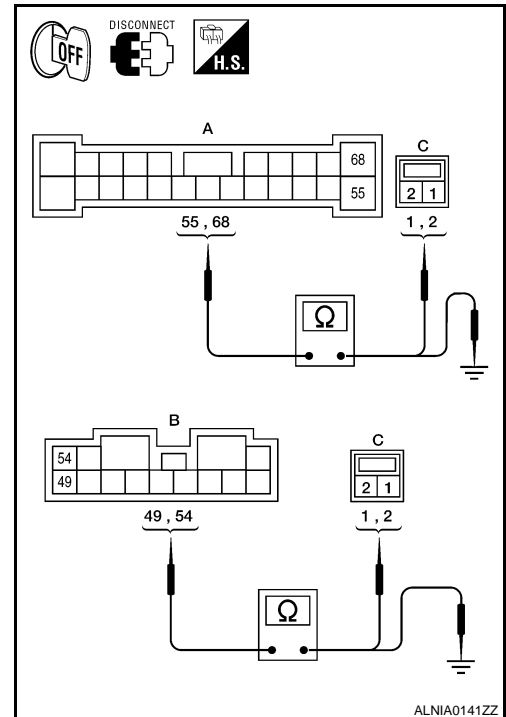

ALNIA0141ZZ

Are the continuity test results as specified?

YES >> GO TO 2

NO >> • Check connector housings for disconnected or loose terminals.  
• Repair harness or connector.

#### 2. REAR DOOR SPEAKER SIGNAL CHECK

# REAR DOOR SPEAKER (SEDAN)

[BOSE AUDIO WITH NAVIGATION]

## < COMPONENT DIAGNOSIS >

1. Connect BOSE speaker amp. connectors B121, B122 and suspect speaker connector.
2. Turn ignition switch to ACC.
3. Push "POWER" switch.
4. Check the signal between BOSE speaker amp. harness connectors (A) B121 and (B) B122 terminals with CONSULT-III or oscilloscope.

Connector	Terminals		Condition	Reference signal
	(+)	(-)		
A: B121	68	55	Receive audio signal	
B: B122	54	49		

SKIA0177E

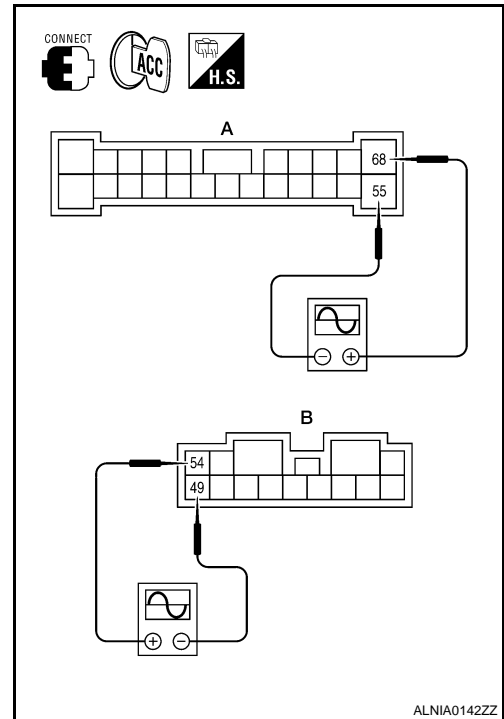

Is the audio signal voltage readings as specified?

- YES >> Replace suspect speaker. Refer to [AV-428. "Removal and Installation - Sedan"](#).
- NO >> GO TO 3.

## 3. HARNESS CHECK

1. Disconnect AV control unit connector M47 and BOSE speaker amp. connector B121.
2. Check continuity between AV control unit harness connector M47 (A) and BOSE speaker amp. harness connector B121 (B).

A		B		Continuity
Connector	Terminal	Connector	Terminal	
M47	5	B121	64	Yes
	6		63	
	14		66	
	15		65	

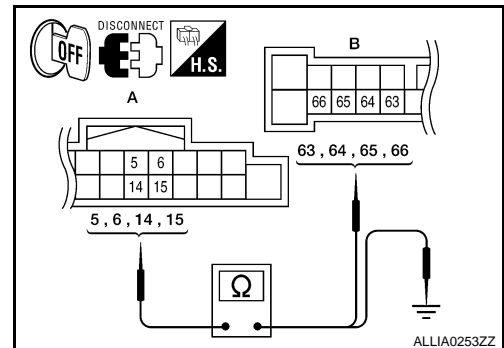

3. Check continuity between AV control unit harness connector M47 (A) and ground.

A		—	Continuity
Connector	Terminal		
M47	5	Ground	No
	6		
	14		
	15		

Are continuity test results as specified?

- YES >> GO TO 4
- NO >> • Check connector housings for disconnected or loose terminals.  
• Repair harness or connector.

## 4. REAR DOOR SPEAKER SIGNAL CHECK

A  
B  
C  
D  
E  
F  
G  
H  
I  
J  
K  
L  
M  
O  
P

AV

## REAR DOOR SPEAKER (SEDAN)

[BOSE AUDIO WITH NAVIGATION]

### < COMPONENT DIAGNOSIS >

1. Connect AV control unit connector M47 and BOSE speaker amp. connector B121.
2. Turn ignition switch to ACC.
3. Push "POWER" switch.
4. Check the signal between AV control unit harness connector M47 terminals with CONSULT-III or oscilloscope.

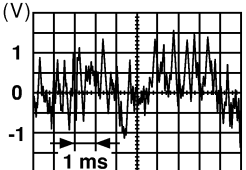
Connector	Terminals		Condition	Reference signal
	(+)	(-)		
M47	5	6	Receive audio signal	 <p style="text-align: right; font-size: small;">SKIA0177E</p>
	14	15		

Are the audio signal voltage readings as specified?

- YES >> Replace BOSE speaker amp. Refer to [AV-423, "Removal and Installation - Sedan"](#).
- NO >> Replace AV control unit. Refer to [AV-422, "Removal and Installation"](#).

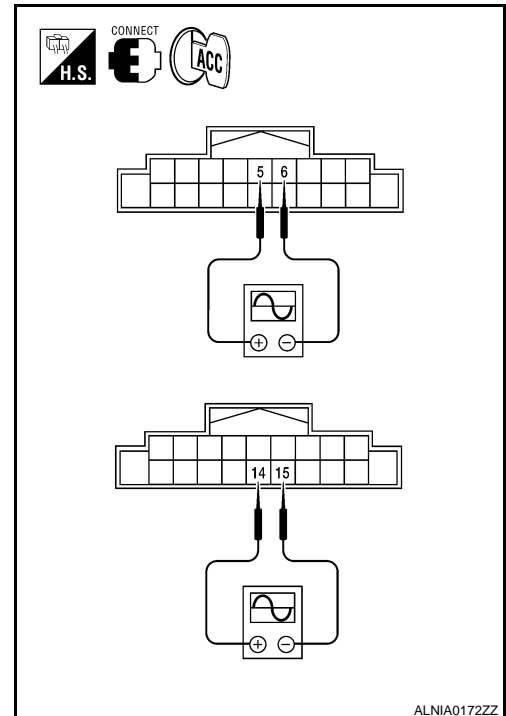

# SUBWOOFER

< COMPONENT DIAGNOSIS >

[BOSE AUDIO WITH NAVIGATION]

## SUBWOOFER

### Description

INFOID:000000001830552

The audio unit sends audio signals to the BOSE speaker amp. The BOSE speaker amp. amplifies the audio signals before sending them to the subwoofers using the audio signal circuits.

### Diagnosis Procedure

INFOID:000000001830553

#### 1. HARNESS CHECK

1. Disconnect BOSE speaker amp. connector B122 and suspect rear subwoofer connector.
2. Check continuity between BOSE speaker amp. harness connector B122 (A) and suspect rear subwoofer harness connector (B).

A		B		Continuity
Connector	Terminal	Connector	Terminal	
B122	53	B120	1	Yes
	48		2	
	45	B124	1	
	46		2	

3. Check continuity between BOSE speaker amp. harness connector B122 (A) and ground.

A		—	Continuity
Connector	Terminal		
B122	53	Ground	No
	48		
	45		
	46		

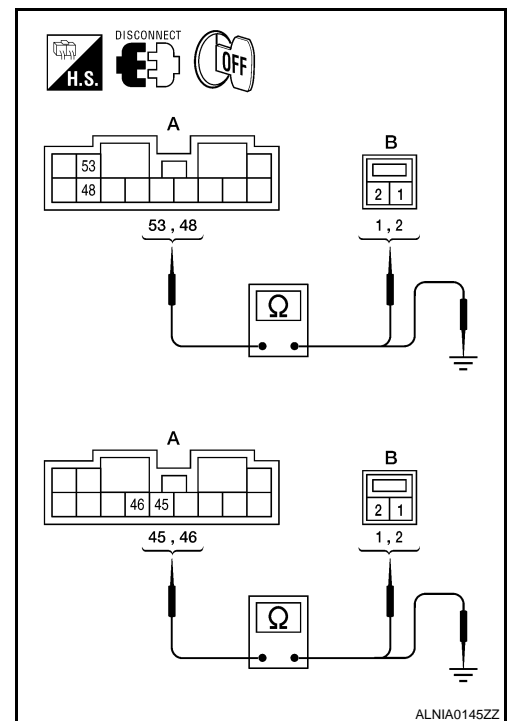

Are the continuity test results as specified?

YES >> GO TO 2

- NO >> • Check connector housings for disconnected or loose terminals.  
• Repair harness or connector.

#### 2. REAR SUBWOOFER SIGNAL CHECK

A  
B  
C  
D  
E  
F  
G  
H  
I  
J  
K  
L  
M  
O  
P

AV

# SUBWOOFER

## < COMPONENT DIAGNOSIS >

## [BOSE AUDIO WITH NAVIGATION]

1. Connect BOSE speaker amp. connector B122 and suspect rear subwoofer connector.
2. Turn ignition switch to ACC.
3. Push "POWER" switch.
4. Check the signal between BOSE speaker amp. harness connector B122 terminals with CONSULT-III or oscilloscope.

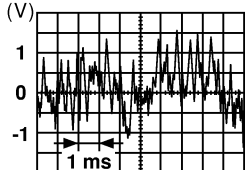
Connector	Terminals		Condition	Reference signal
	(+)	(-)		
B122	53	48	Receive audio signal	
	45	46		

SKIA0177E

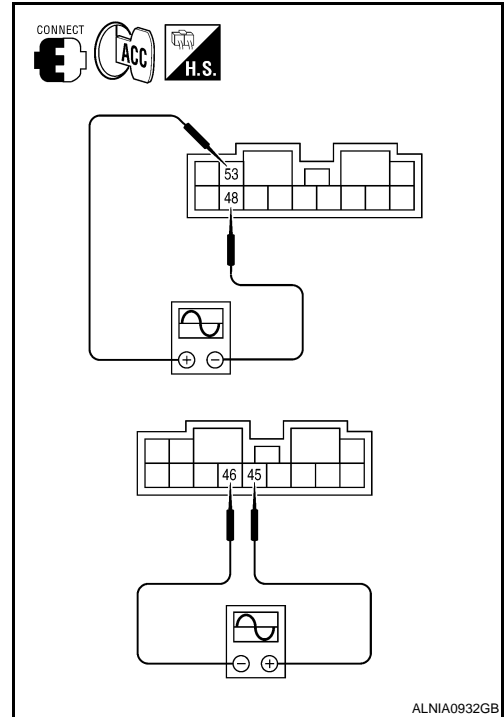

**Is the audio signal voltage as specified?**

YES >> Replace suspect rear subwoofer. For coupe, refer to [AV-430, "Removal and Installation - Coupe"](#). For sedan, refer to [AV-430, "Removal and Installation - Sedan"](#).

NO >> GO TO 3

### 3. HARNESS CHECK

1. Disconnect AV control unit connector M47 and BOSE speaker amp. connector B121.
2. Check continuity between AV control unit harness connector M47 (A) and BOSE speaker amp. harness connector B121 (B).

A		B.		Continuity
Connector	Terminal	Connector	Terminal	
M47	5	B121	64	Yes
	6		63	
	14		66	
	15		65	

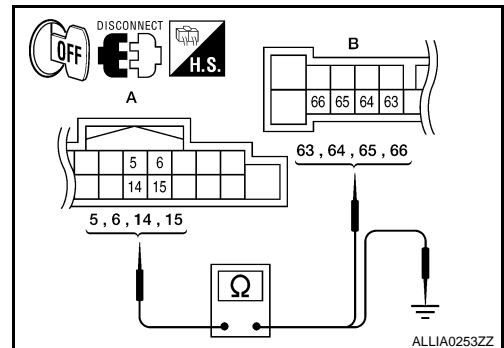

3. Check continuity between AV control unit harness connector M47 (A) and ground.

A		—	Continuity
Connector	Terminal		
M47	5	Ground	No
	6		
	14		
	15		

**Are continuity test results as specified?**

YES >> GO TO 4

NO >> • Check connector housings for disconnected or loose terminals.  
• Repair harness or connector.

### 4. REAR SUBWOOFER SIGNAL CHECK



# SUBWOOFER

## < COMPONENT DIAGNOSIS >

## [BOSE AUDIO WITH NAVIGATION]

1. Connect AV control unit connector M47 and BOSE speaker amp. connector B121.
2. Turn ignition switch to ACC.
3. Push "POWER" switch.
4. Check the signal between AV control unit harness connector M47 terminals with CONSULT-III or oscilloscope.

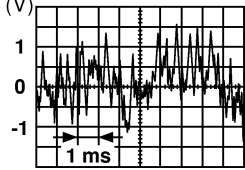
Connector	Terminals		Condition	Reference signal
	(+)	(-)		
M47	5	6	Receive audio signal	 <small>SKIA0177E</small>
	14	15		

Are the audio signal voltage readings as specified?

- YES >> Replace BOSE speaker amp. Refer to [AV-205, "Removal and Installation - Coupe"](#).
- NO >> Replace AV control unit. Refer to [AV-422, "Removal and Installation"](#).

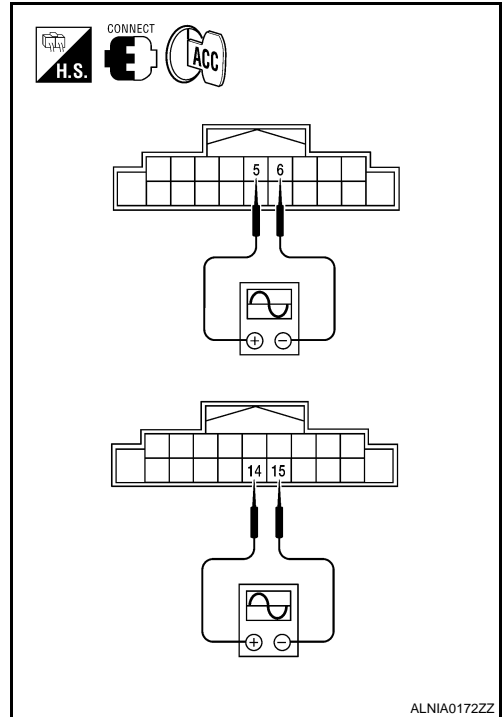

A  
B  
C  
D  
E  
F  
G  
H  
I  
J  
K  
L  
M  
O  
P

AV

# AMP ON SIGNAL CIRCUIT

< COMPONENT DIAGNOSIS >

[BOSE AUDIO WITH NAVIGATION]

## AMP ON SIGNAL CIRCUIT

### Description

INFOID:000000001830554

When the audio system is turned on, a voltage signal is supplied from the AV control unit to the BOSE speaker amp. When this signal is received, the BOSE speaker amp. will turn on.

### Diagnosis Procedure

INFOID:000000001830555

#### 1. CHECK AMP ON SIGNAL (BOSE SPEAKER AMP)

1. Turn audio system ON.
2. Check voltage between BOSE speaker amp. harness connector B121 terminal 60 and ground.

**60 - Ground : More than approx. 6.5V**

Is voltage greater than 6.5V?

- YES >> INSPECTION END.  
NO >> GO TO 2

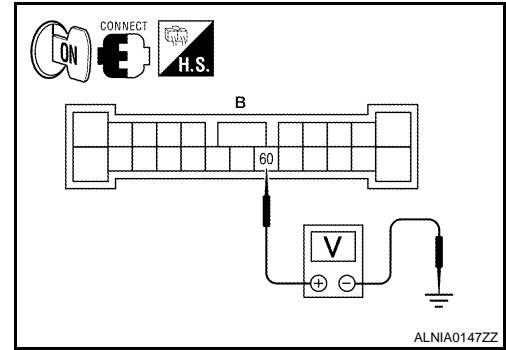

#### 2. CHECK AMP ON SIGNAL (AV CONTROL UNIT)

Check voltage between AV control unit harness connector M47 terminal 16 and ground.

**16 - Ground : More than approx. 6.5V**

Is voltage approximately 6.5 volts?

- YES >> Repair harness or connector.  
NO >> Replace AV control unit. Refer to [AV-422, "Removal and Installation"](#).

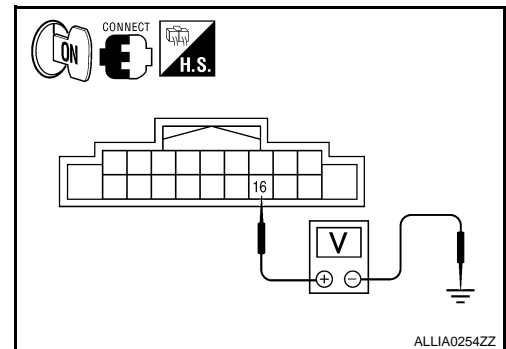

# STEERING SWITCH

< COMPONENT DIAGNOSIS >

[BOSE AUDIO WITH NAVIGATION]

## STEERING SWITCH

### Description

INFOID:000000001830556

When one of the steering wheel audio control switches is pushed, the resistance in the steering switch circuit changes depending on which button is pushed.

### Diagnosis Procedure

INFOID:000000001830557

#### 1. CHECK HARNESS

1. Turn ignition switch OFF.
2. Disconnect AV control unit connector M46 and spiral cable connector M30.
3. Check continuity between AV control unit connector M46 terminals 25, 26, and 27 and spiral cable connector M30 terminals 24, 31, and 33.

A		B		Continuity
Connector	Terminal	Connector	Terminal	
M46	25	M30	24	Yes
	26		33	
	27		31	

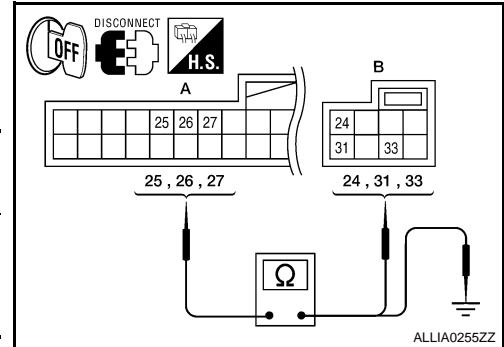

4. Check continuity between AV control unit connector M46 (A) and ground.

A		-	Continuity
Connector	Terminal		
M46	25	Ground	No
	26		
	27		

Are the continuity test results as specified?

- YES >> GO TO 2  
 NO >> Repair harness.

#### 2. SPIRAL CABLE CHECK

1. Disconnect spiral cable connector M88.
2. Check continuity between spiral cable harness connector M30 and M88.

A		B		Continuity
Connector	Terminal	Connector	Terminal	
M30	24	M88	14	Yes
	31		15	
	33		17	

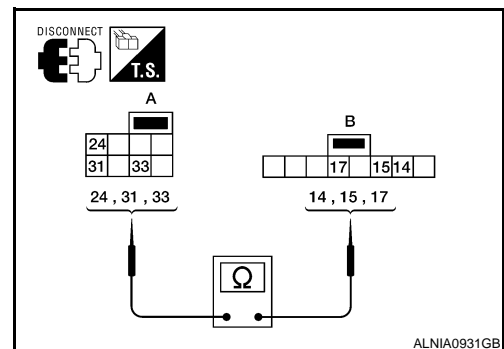

Are the continuity test results as specified?

- YES >> GO TO 3.  
 NO >> Replace spiral cable. Refer to [SR-6, "Removal and Installation"](#).

#### 3. CHECK STEERING SWITCH

Check steering switch. Refer to [AV-344, "Component Inspection"](#).

Does the steering switch pass inspection?

- YES >> INSPECTION END.  
 NO >> Replace steering switch. Refer to [AV-434, "Removal and Installation"](#).

# STEERING SWITCH

< COMPONENT DIAGNOSIS >

[BOSE AUDIO WITH NAVIGATION]

## Component Inspection

INFOID:000000001830558

Measure the resistance between the steering switch connector terminals 14 to 17 and 15 to 17.

Standard

**Between terminals 14 and 17**

**ENTER switch ON : 2003 – 2043  $\Omega$**

**↩ switch ON : 716 – 730  $\Omega$**

**MENU DOWN switch ON : 318 – 324  $\Omega$**

**MENU UP switch ON : 120 – 122  $\Omega$**

**SOURCE switch ON : 0  $\Omega$**

**Between terminals 15 and 17**

**↩ switch ON : 716 – 730  $\Omega$**

**↶ switch ON : 318 – 324  $\Omega$**

**VOL UP switch ON : 120 – 122  $\Omega$**

**VOL DOWN switch ON : 0  $\Omega$**

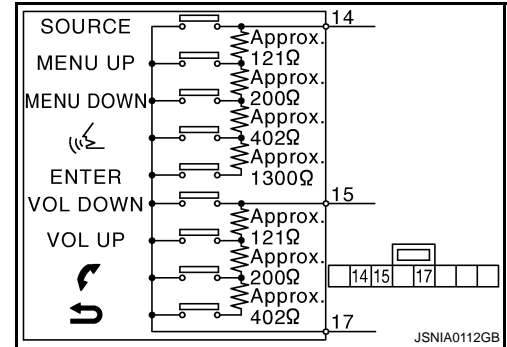

JSNIA0112GB

# MICROPHONE SIGNAL CIRCUIT

< COMPONENT DIAGNOSIS >

[BOSE AUDIO WITH NAVIGATION]

## MICROPHONE SIGNAL CIRCUIT

### Description

INFOID:000000001830559

Power is supplied to the microphone from the AV control unit. The microphone transmits voice signals to the AV control unit.

### Diagnosis Procedure

INFOID:000000001830560

#### 1. CHECK CONTINUITY BETWEEN AV CONTROL UNIT AND MICROPHONE CIRCUIT

1. Turn ignition switch OFF.
2. Disconnect AV control unit connector M46 and microphone connector R7.
3. Check continuity between AV control unit harness connector M46 (A) terminals 45, 46, 47 and microphone harness connector R7 (B) terminals 1, 2, 4.

**45 - 1 : Continuity should exist.**

**47 - 2 : Continuity should exist.**

**46 - 4 : Continuity should exist.**

4. Check continuity between AV control unit harness connector M46 (A) terminals 45, 46, 47 and ground.

**45, 46, 47 - Ground : Continuity should not exist.**

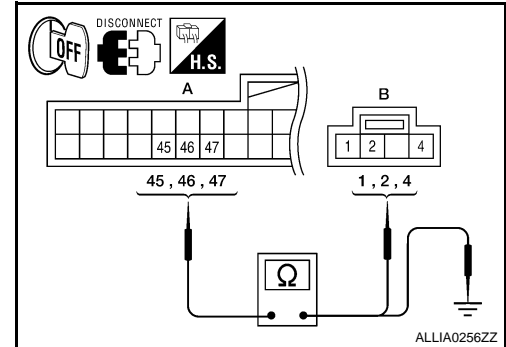

Is inspection result OK?

YES >> GO TO 2

NO >> Repair harness or connector.

#### 2. CHECK MICROPHONE VCC VOLTAGE

1. Connect AV control unit connector.
2. Turn ignition switch ON.
3. Check voltage between AV control unit harness connector M46 terminals 46 and 47.

**46 - 47 : Approx. 5V**

Is inspection result OK?

YES >> GO TO 3

NO >> Replace AV control unit. Refer to [AV-422, "Removal and Installation"](#).

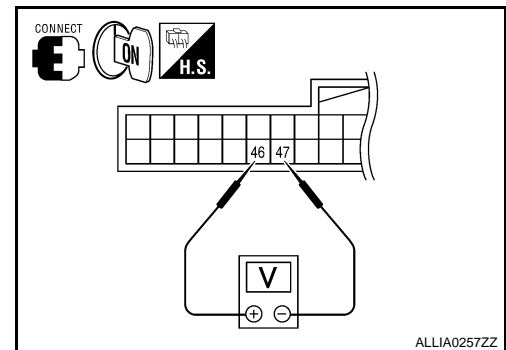

#### 3. CHECK MICROPHONE SIGNAL

1. Connect microphone connector.
2. Check signal between AV control unit harness connector M46 terminals 45 and 47.

**45 - 47 :**

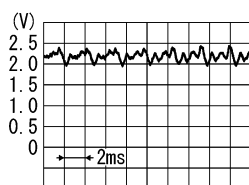

PKIB5037J

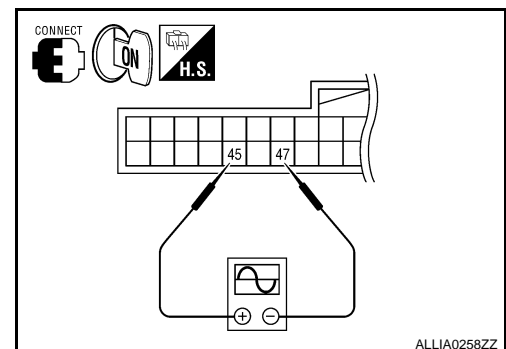

Is inspection result OK?

YES >> Replace AV control unit. Refer to [AV-422, "Removal and Installation"](#).

A  
B  
C  
D  
E  
F  
G  
H  
I  
J  
K  
L  
M  
N  
O  
P

AV

## MICROPHONE SIGNAL CIRCUIT

< COMPONENT DIAGNOSIS >

[BOSE AUDIO WITH NAVIGATION]

---

NO >> Replace microphone. For coupe, refer to [AV-442, "Removal and Installation - Coupe"](#). For sedan, refer to, [AV-442, "Removal and Installation - Sedan"](#).

# CAMERA IMAGE SIGNAL CIRCUIT (REAR VIEW CAMERA TO CAMERA CONTROL UNIT)(COUPE)

< COMPONENT DIAGNOSIS >

[BOSE AUDIO WITH NAVIGATION]

## CAMERA IMAGE SIGNAL CIRCUIT (REAR VIEW CAMERA TO CAMERA CONTROL UNIT)(COUPE)

### Description

INFOID:000000001830561

Rear view camera images are transmitted to the rear view camera control unit using the camera image signal circuits.

### Diagnosis Procedure

INFOID:000000001830562

#### 1. CHECK CAMERA IMAGE SIGNAL CIRCUIT CONTINUITY

1. Turn ignition switch OFF.
2. Disconnect rear view camera control unit connector and rear view camera connector.
3. Check continuity between rear view camera control unit harness connector B31 (A) terminals 9, 10 and rear view camera harness connector T7 (B) terminals 3, 4.

**9 - 4** : Continuity should exist.

**10 - 3** : Continuity should exist.

4. Check continuity between rear view camera control unit harness connector B31 (A) terminals 9, 10 and ground.

**9, 10 - Ground** : Continuity should not exist.

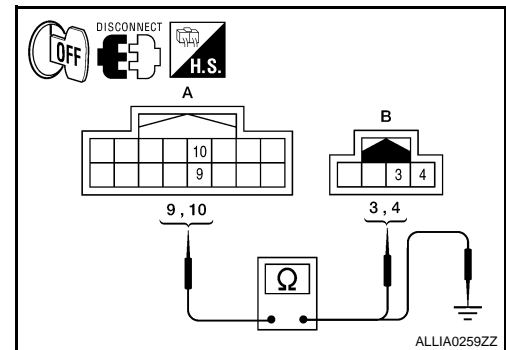

Is inspection result OK?

YES >> GO TO 2

NO >> Repair harness or connector.

#### 2. CHECK CAMERA IMAGE SIGNAL

1. Connect rear view camera control unit connector and rear view camera connector.
2. Turn ignition switch ON.
3. Check signal between rear view camera control unit harness connector B31 terminals 10 and 9.

**10 - 9** :

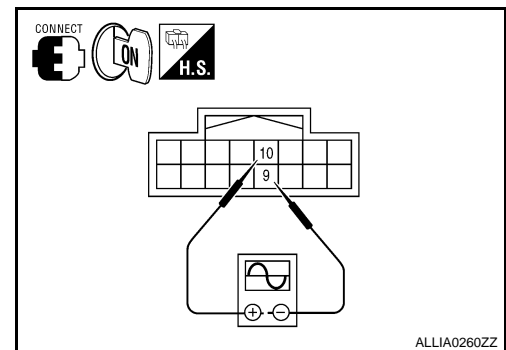
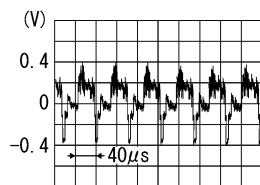

Is inspection result OK?

YES >> Replace rear view camera control unit. Refer to [AV-447. "Removal and Installation - Coupe"](#).

NO >> Replace rear view camera. Refer to [AV-446. "Removal and Installation"](#).

# CAMERA IMAGE SIGNAL CIRCUIT (REAR VIEW CAMERA TO CAMERA CONTROL UNIT)(SEDAN)

< COMPONENT DIAGNOSIS >

[BOSE AUDIO WITH NAVIGATION]

## CAMERA IMAGE SIGNAL CIRCUIT (REAR VIEW CAMERA TO CAMERA CONTROL UNIT)(SEDAN)

### Description

INFOID:000000003214809

Rear view camera images are transmitted to the rear view camera control unit using the camera image signal circuits.

### Diagnosis Procedure

INFOID:000000003214810

#### 1. CHECK CAMERA IMAGE SIGNAL CIRCUIT CONTINUITY

1. Turn ignition switch OFF.
2. Disconnect rear view camera control unit connector and rear view camera connector.
3. Check continuity between rear view camera control unit harness connector B31 (A) terminals 9, 10 and rear view camera harness connector B35 (B) terminals 3, 4.

**9 - 4** : Continuity should exist.

**10 - 3** : Continuity should exist.

4. Check continuity between rear view camera control unit harness connector B31 (A) terminals 9, 10 and ground.

**9, 10 - Ground** : Continuity should not exist.

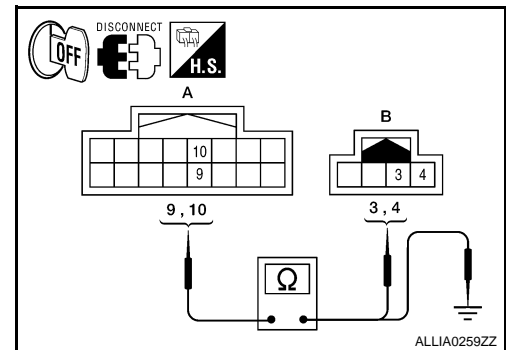

Is inspection result OK?

YES >> GO TO 2

NO >> Repair harness or connector.

#### 2. CHECK CAMERA IMAGE SIGNAL

1. Connect rear view camera control unit connector and rear view camera connector.
2. Turn ignition switch ON.
3. Check signal between rear view camera control unit harness connector B31 terminals 10 and 9.

**10 - 9** :

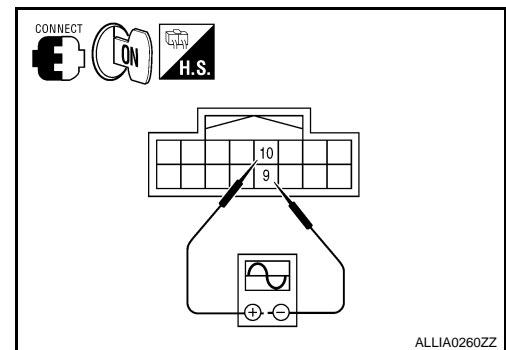
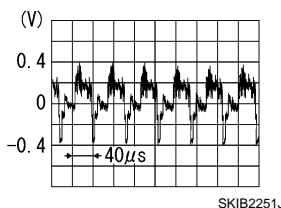

Is inspection result OK?

YES >> Replace rear view camera control unit. Refer to [AV-447, "Removal and Installation - Sedan"](#).

NO >> Replace rear view camera. Refer to [AV-446, "Removal and Installation"](#).



# CAMERA ON SIGNAL CIRCUIT (COUPE)

[BOSE AUDIO WITH NAVIGATION]

< COMPONENT DIAGNOSIS >

## CAMERA ON SIGNAL CIRCUIT (COUPE)

### Description

INFOID:000000001830563

When the selector lever is placed in the R position, the rear view camera control unit sends a camera ON signal to the rear view camera.

### Diagnosis Procedure

INFOID:000000001830564

#### 1. CHECK CAMERA ON SIGNAL CIRCUIT CONTINUITY

1. Turn ignition switch OFF.
2. Disconnect rear view camera control unit connector and rear view camera connector.
3. Check continuity between rear view camera control unit harness connector B31 (A) terminal 8 and rear view camera harness connector T7 (B) terminal 1.

**8 - 1 : Continuity should exist.**

4. Check continuity between rear view camera control unit harness connector B31 (B) terminal 8 and ground.

**8 - Ground : Continuity should not exist.**

Is inspection result OK?

YES >> GO TO 2

NO >> Repair harness or connector.

#### 2. CHECK CAMERA ON SIGNAL VOLTAGE

1. Connect rear view camera control unit connector and rear view camera connector.
2. Turn ignition switch ON.
3. Check voltage between rear view camera control unit harness connector B31 terminal 8 and ground.

**8 - Ground : Approx. 6V**

Is inspection result OK?

YES >> Replace rear view camera. Refer to [AV-446. "Removal and Installation"](#).

NO >> Replace rear view camera control unit. Refer to [AV-447. "Removal and Installation - Coupe"](#).

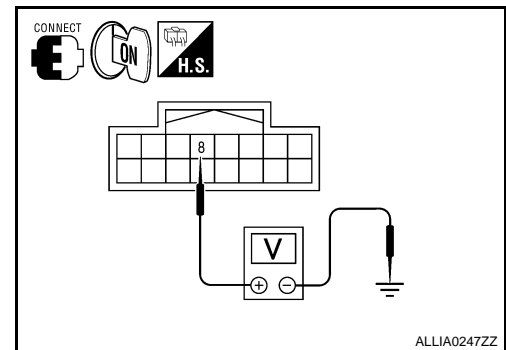
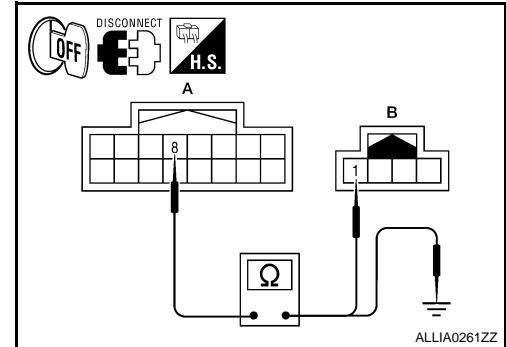

A  
B  
C  
D  
E  
F  
G  
H  
I  
J  
K  
L  
M  
O  
P

AV

# CAMERA ON SIGNAL CIRCUIT (SEDAN)

[BOSE AUDIO WITH NAVIGATION]

< COMPONENT DIAGNOSIS >

## CAMERA ON SIGNAL CIRCUIT (SEDAN)

### Description

INFOID:000000003214811

When the selector lever is placed in the R position, the rear view camera control unit sends a camera ON signal to the rear view camera.

### Diagnosis Procedure

INFOID:000000003214812

#### 1. CHECK CAMERA ON SIGNAL CIRCUIT CONTINUITY

1. Turn ignition switch OFF.
2. Disconnect rear view camera control unit connector and rear view camera connector.
3. Check continuity between rear view camera control unit harness connector B31 (A) terminal 8 and rear view camera harness connector B35 (B) terminal 1.

**8 - 1 : Continuity should exist.**

4. Check continuity between rear view camera control unit harness connector B31 (B) terminal 8 and ground.

**8 - Ground : Continuity should not exist.**

Is inspection result OK?

YES >> GO TO 2

NO >> Repair harness or connector.

#### 2. CHECK CAMERA ON SIGNAL VOLTAGE

1. Connect rear view camera control unit connector and rear view camera connector.
2. Turn ignition switch ON.
3. Check voltage between rear view camera control unit harness connector B31 terminal 8 and ground.

**8 - Ground : Approx. 6V**

Is inspection result OK?

YES >> Replace rear view camera. Refer to [AV-446, "Removal and Installation"](#).

NO >> Replace rear view camera control unit. Refer to [AV-447, "Removal and Installation - Sedan"](#).

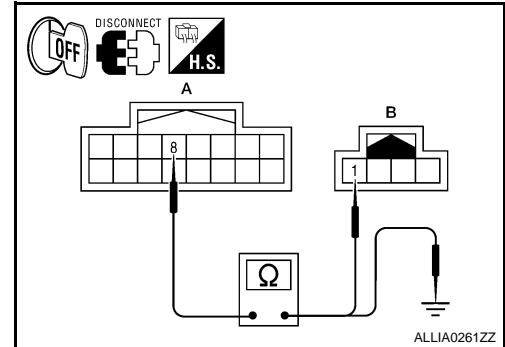

ALLIA0261ZZ

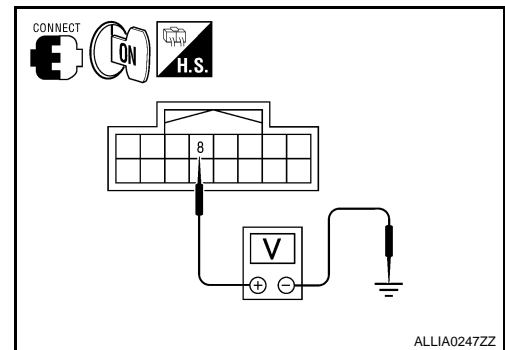

ALLIA0247ZZ

# CAMERA IMAGE SIGNAL CIRCUIT (CAMERA CONTROL UNIT TO AV CONTROL UNIT)

< COMPONENT DIAGNOSIS >

[BOSE AUDIO WITH NAVIGATION]

## CAMERA IMAGE SIGNAL CIRCUIT (CAMERA CONTROL UNIT TO AV CONTROL UNIT)

### Description

INFOID:000000001830565

Rear view camera image signals are transmitted from the rear view camera control unit to the AV control unit using the image signal circuits.

### Diagnosis Procedure

INFOID:000000001830566

#### 1. CHECK CAMERA IMAGE SIGNAL CIRCUIT CONTINUITY

1. Turn ignition switch OFF.
2. Disconnect rear view camera control unit connector B31 and AV control unit connector M46.
3. Check continuity between rear view camera control unit harness connector B31 (A) terminals 11, 12 and AV control unit harness connector M46 (B) terminals 34, 55.

**11 - 55** : Continuity should exist.

**12 - 34** : Continuity should exist.

4. Check continuity between rear view camera control unit harness connector B31 (A) terminals 11, 12 and ground.

**11, 12 - Ground** : Continuity should not exist.

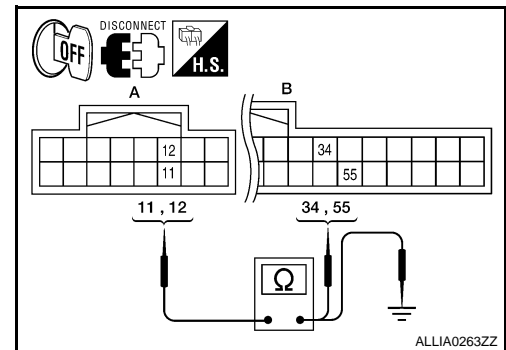

Is inspection result OK?

YES >> GO TO 2

NO >> Repair harness or connector.

#### 2. CHECK CAMERA IMAGE SIGNAL

1. Connect rear view camera control unit connector and AV control unit connector.
2. Turn ignition switch ON.
3. Check signal between rear view camera control unit harness connector B31 terminals 12 and 11.

**12 - 11** :

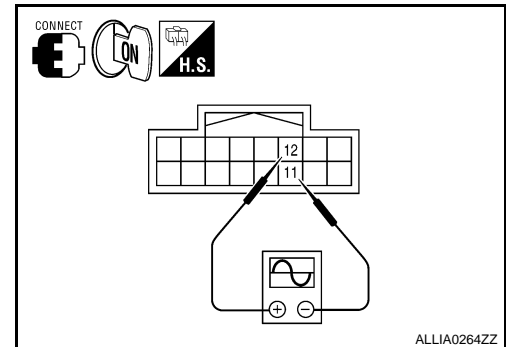
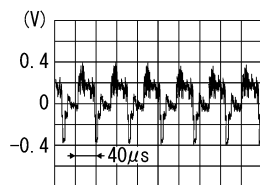

Is inspection result OK?

YES >> Replace AV control unit. Refer to [AV-422. "Removal and Installation"](#).

NO >> Replace rear view camera control unit. For coupe, refer to [AV-447. "Removal and Installation - Coupe"](#). For sedan, refer to [AV-447. "Removal and Installation - Sedan"](#).

## REVERSE SIGNAL CIRCUIT

### Description

INFOID:000000001830567

A reverse signal is supplied from the back-up lamp relay to the rear view camera control unit. When this signal is received, the display shows a view to the rear of the vehicle.

### Diagnosis Procedure

INFOID:000000001830568

#### 1. BACK-UP LAMP INSPECTION

1. Turn ignition switch ON.
2. Shift selector lever to R position.

Does back-up lamp illuminate?

- YES >> GO TO 2  
 NO >> Check back-up lamp system. Refer to [EXL-4, "Work Flow"](#).

#### 2. CHECK REVERSE POSITION INPUT SIGNAL

##### With CONSULT-III

Select "DATA MONITOR" of "REARVIEW CAMERA". Operate ignition switch with "R POSI SIG" of "DATA MONITOR" and check operate status.

##### Without CONSULT-III

1. Turn ignition switch OFF.
2. Disconnect rear view camera control unit connector.
3. Turn ignition switch ON.
4. Shift selector lever to R position.
5. Check voltage between rear view camera control unit harness connector B31 terminal 4 and ground.

**Battery voltage should exist.**

Does battery voltage exist?

- YES >> Inspection End.  
 NO >> Check harness for open or short between rear view camera control unit and back-up lamp relay.

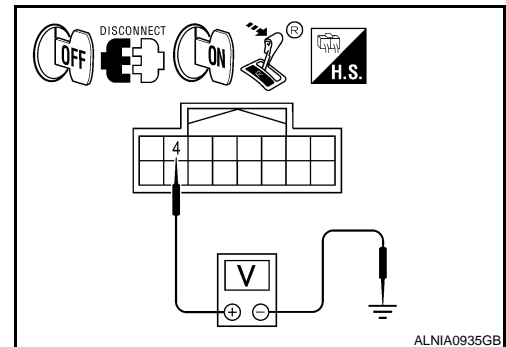

# AV CONTROL UNIT (COUPE)

< ECU DIAGNOSIS >

[BOSE AUDIO WITH NAVIGATION]

## ECU DIAGNOSIS

### AV CONTROL UNIT (COUPE)

Reference Value

INFOID:000000001830569

#### VALUES ON THE DIAGNOSIS TOOL

CONSULT-III data monitor item

Display Item	Display	Vehicle status	Remarks
VHCL SPD SIG	ON	Vehicle speed > 0 km/h (0 MPH)	Changes in indication may be delayed. This is normal.
	OFF	Vehicle speed = 0 km/h (0 MPH)	
PKB SIG	ON	Parking brake is applied.	
	OFF	Parking brake is released.	
ILLUM SIG	ON	Block the light beam from the auto light optical sensor when the light SW is ON .	—
	OFF	Expose the auto light optical sensor to light when the light SW is OFF or ON.	
IGN SIG	ON	Ignition switch ON	
	OFF	Ignition switch in ACC position	
REV SIG	ON	Selector lever in R position	Changes in indication may be delayed. This is normal.
	OFF	Selector lever in any position other than R	

#### TERMINAL LAYOUT

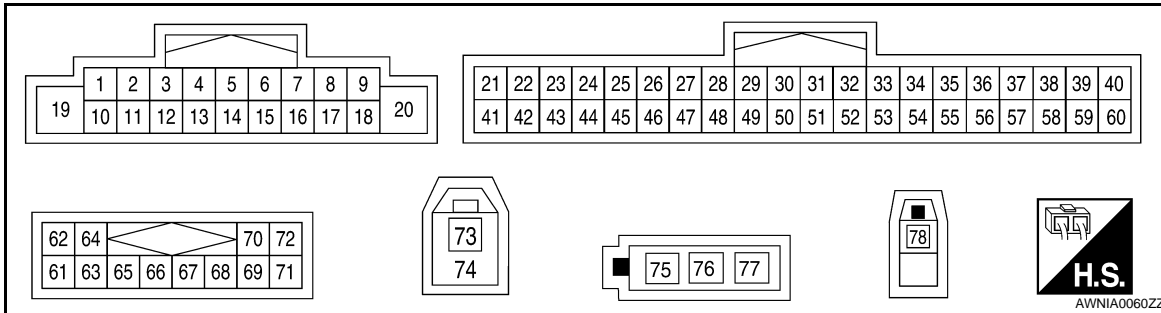

#### PHYSICAL VALUES

Terminal (Wire color)		Description	Condition			Reference value (Approx.)
+	-	Signal name	Input/Output	Ignition switch	Operation	
1 (G/R)	Ground	Parking brake signal	Input	Ignition switch ON	Parking brake ON	0V
					Parking brake OFF	Battery voltage
2 (G)	3 (R)	Sound signal front LH	Output	Ignition switch ON	—	<p>SKIB3609E</p>
4	—	Shield	—	—	—	—

# AV CONTROL UNIT (COUPE)

[BOSE AUDIO WITH NAVIGATION]

< ECU DIAGNOSIS >

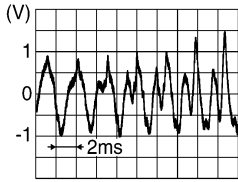
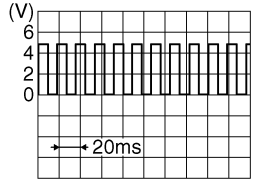
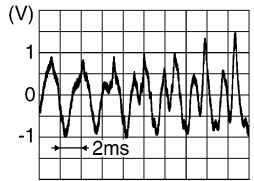
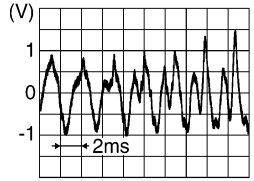
Terminal (Wire color)		Description		Condition		Reference value (Approx.)
+	-	Signal name	Input/ Output	Ignition switch	Operation	
5 (GR/V)	6 (W/L)	Sound signal rear LH	Output	Ignition switch ON	—	 <p style="text-align: right; font-size: small;">SKIB3609E</p>
7 (V/Y)	Ground	ACC power supply	Input	Ignition switch ACC	—	Battery voltage
8 (V/W)	Ground	Vehicle speed (8-pulse) signal	Input	Ignition switch ON	When vehicle speed is ap- prox. 40 km/h (25MPH)	 <p style="text-align: right; font-size: small;">SKIA6649J</p>
9 (R/L)	Ground	Illumination signal	Input	OFF	Lighting switch is OFF.	0V
					Lighting switch is ON.	Battery voltage
10 (G)	Ground	Ignition signal	Input	Ignition switch ON	—	Battery voltage
11 (B)	12 (W)	Sound signal front RH	Output	Ignition switch ON	—	 <p style="text-align: right; font-size: small;">SKIB3609E</p>
13	—	Shield	—	—	—	—
14 (V)	15 (LG)	Sound signal rear RH	Output	Ignition switch ON	—	 <p style="text-align: right; font-size: small;">SKIB3609E</p>
16 (B/P)	Ground	Amp. ON signal	Output	Ignition switch ON	—	Battery voltage
17 (P/B)	Ground	Reverse signal	Input	Ignition switch ON	R position	Battery voltage
18 (R/Y)	Ground	Illumination control	Input	OFF	—	Refer to <a href="#">INL-10, "System De- scription"</a> .
19 (B)	Ground	Ground	—	Ignition switch ON	—	0V

# AV CONTROL UNIT (COUPE)

< ECU DIAGNOSIS >

[BOSE AUDIO WITH NAVIGATION]

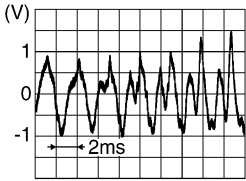
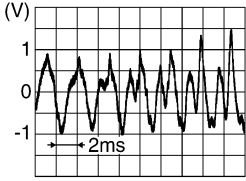
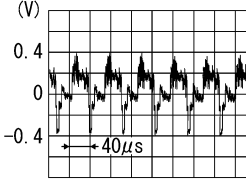
Terminal (Wire color)		Description		Condition		Reference value (Approx.)
+	-	Signal name	Input/ Output	Ignition switch	Operation	
20 (Y/R)	Ground	Battery power supply	Input	Ignition switch OFF	—	Battery voltage
24 (L)	—	CAN-H	Input/ Output	—	—	—
25 (W/G)	26 (L/B)	Steering switch signal 1	Input	Ignition switch ON	Keep pressing SOURCE switch.	0V
					Keep pressing MENU UP switch.	1V
					Keep pressing MENU DOWN switch.	2V
					Keep pressing  switch	3V
					Keep pressing ENTER switch.	4V
					Except for above.	5V
26 (L/B)	Ground	Steering switch signal ground	—	Ignition switch ON	—	0V
27 (GR/L)	26 (L/B)	Steering switch signal 2	Input	Ignition switch ON	Keep pressing VOL DOWN switch.	0V
					Keep pressing VOL UP switch.	1V
					Keep pressing  switch.	2V
					Keep pressing  switch.	3V
					Except for above.	5V
28	—	Shield	—	—	—	—
31 (W/R)	Ground	AUX sound signal RH	Input	Ignition switch ON	When AUX mode is select- ed	
32	—	Shield	—	—	—	—
33 (W/L)	Ground	AUX sound signal LH	Input	Ignition switch ON	When AUX mode is select- ed	
34 (W)	Ground	Camera image signal	Input	Ignition switch ON	Rear view camera image displayed	

A  
B  
C  
D  
E  
F  
G  
H  
I  
J  
K  
L  
M  
AV  
O  
P

# AV CONTROL UNIT (COUPE)

[BOSE AUDIO WITH NAVIGATION]

< ECU DIAGNOSIS >

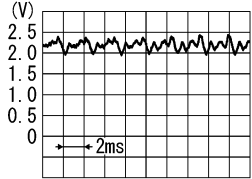
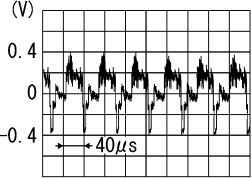
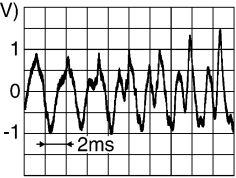
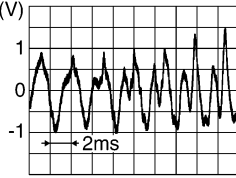
Terminal (Wire color)		Description		Condition		Reference value (Approx.)
+	-	Signal name	Input/ Output	Ignition switch	Operation	
35	—	Shield	—	—	—	—
44 (P)	—	CAN-L	Input/ Output	—	—	—
45 (B/R)	Ground	Microphone signal	Input	Ignition switch ON	—	 <p style="text-align: right; font-size: small;">PKIB5037J</p>
46 (R/L)	Ground	Microphone VCC	Output	Ignition switch ON	—	5V
47 (R/B)	Ground	Microphone ground	—	Ignition switch ON	—	0V
48	—	Shield	—	—	—	—
53 (V/G)	Ground	Camera-connection rec- ognition signal	Input	Ignition switch ON	Connected to camera con- trol unit connector	0V
					Not connected to camera control unit connector	5V
55 (R)	Ground	Camera image signal	Input	Ignition switch ON	Rear view camera image displayed	 <p style="text-align: right; font-size: small;">SKIB2251J</p>
62 (Y/L)	61 (W/L)	CD changer sound sig- nal LH	Input	Ignition switch ON	—	 <p style="text-align: right; font-size: small;">SKIB3609E</p>
64 (Y/G)	63 (BR/L)	CD changer sound sig- nal RH	Input	Ignition switch ON	—	 <p style="text-align: right; font-size: small;">SKIB3609E</p>
65	—	Shield	—	—	—	—
66	—	Shield	—	—	—	—



# AV CONTROL UNIT (COUPE)

< ECU DIAGNOSIS >

[BOSE AUDIO WITH NAVIGATION]

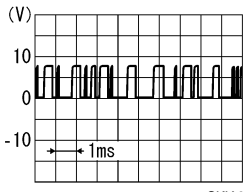
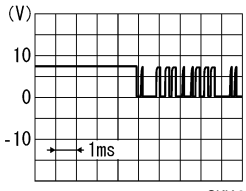
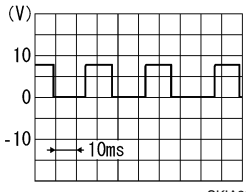
Terminal (Wire color)		Description		Condition		Reference value (Approx.)
+	-	Signal name	Input/ Output	Ignition switch	Operation	
69 (B)	Ground	Communication signal (CD→CONT)	Input	Ignition switch ON	—	
70 (G)	Ground	Communication signal (CONT→CD)	Input	Ignition switch ON	—	
72 (R)	Ground	Request signal (CD→CONT)	Output	Ignition switch ON	—	
73 (B)	—	GPS signal	Input	Ignition switch ACC	Not connected to GPS an- tenna connector	5V
74 (B)	—	Shield	—	—	—	—
75 (B)	Ground	Antenna amp. power supply	Output	Ignition switch ACC	—	Battery voltage
76 (B)	—	Main antenna	Input	—	—	—
78 (B)	Ground	Satellite antenna signal	Input	Ignition switch ACC	Not connected to satellite antenna connector	5V

A  
B  
C  
D  
E  
F  
G  
H  
I  
J  
K  
L  
M

AV

O  
P

# AV CONTROL UNIT (COUPE)

[BOSE AUDIO WITH NAVIGATION]

< ECU DIAGNOSIS >

## Wiring Diagram

INFOID:000000001830570

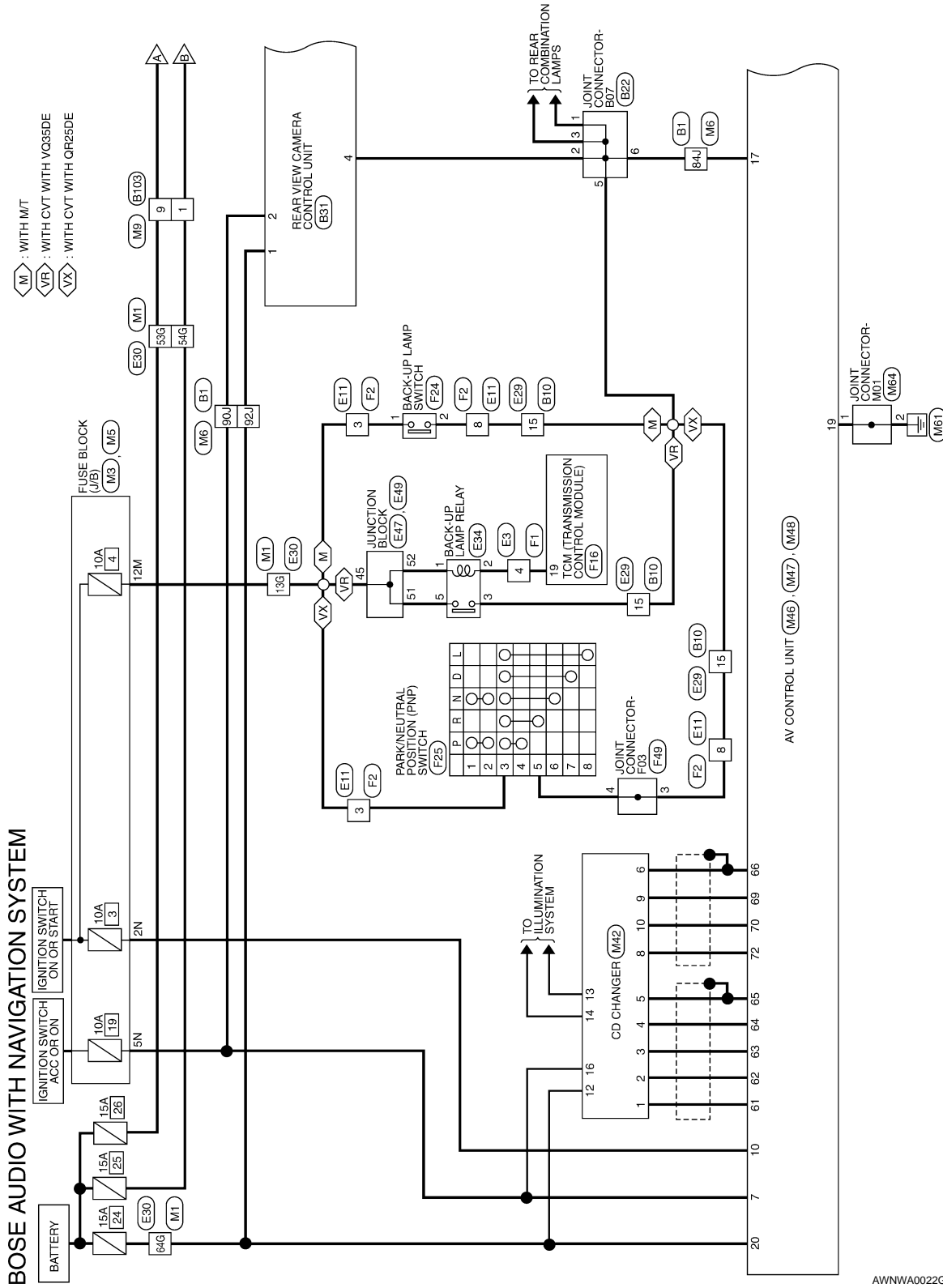

AWNWA0022G

# AV CONTROL UNIT (COUPE)

[BOSE AUDIO WITH NAVIGATION]

< ECU DIAGNOSIS >

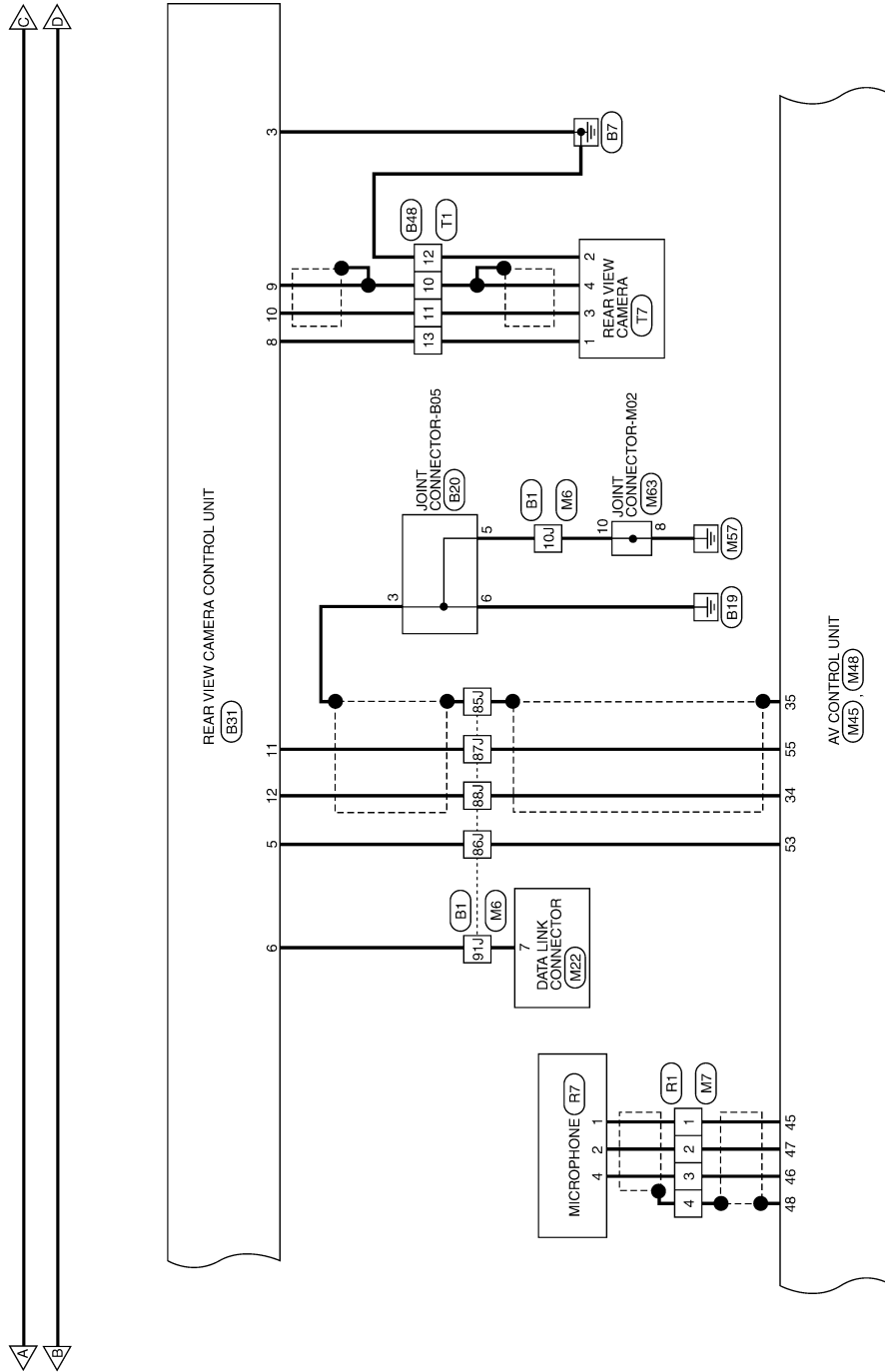

A  
B  
C  
D  
E  
F  
G  
H  
I  
J  
K  
L  
M  
O  
P

AV

AWNWA0023G

# AV CONTROL UNIT (COUPE)

[BOSE AUDIO WITH NAVIGATION]

< ECU DIAGNOSIS >

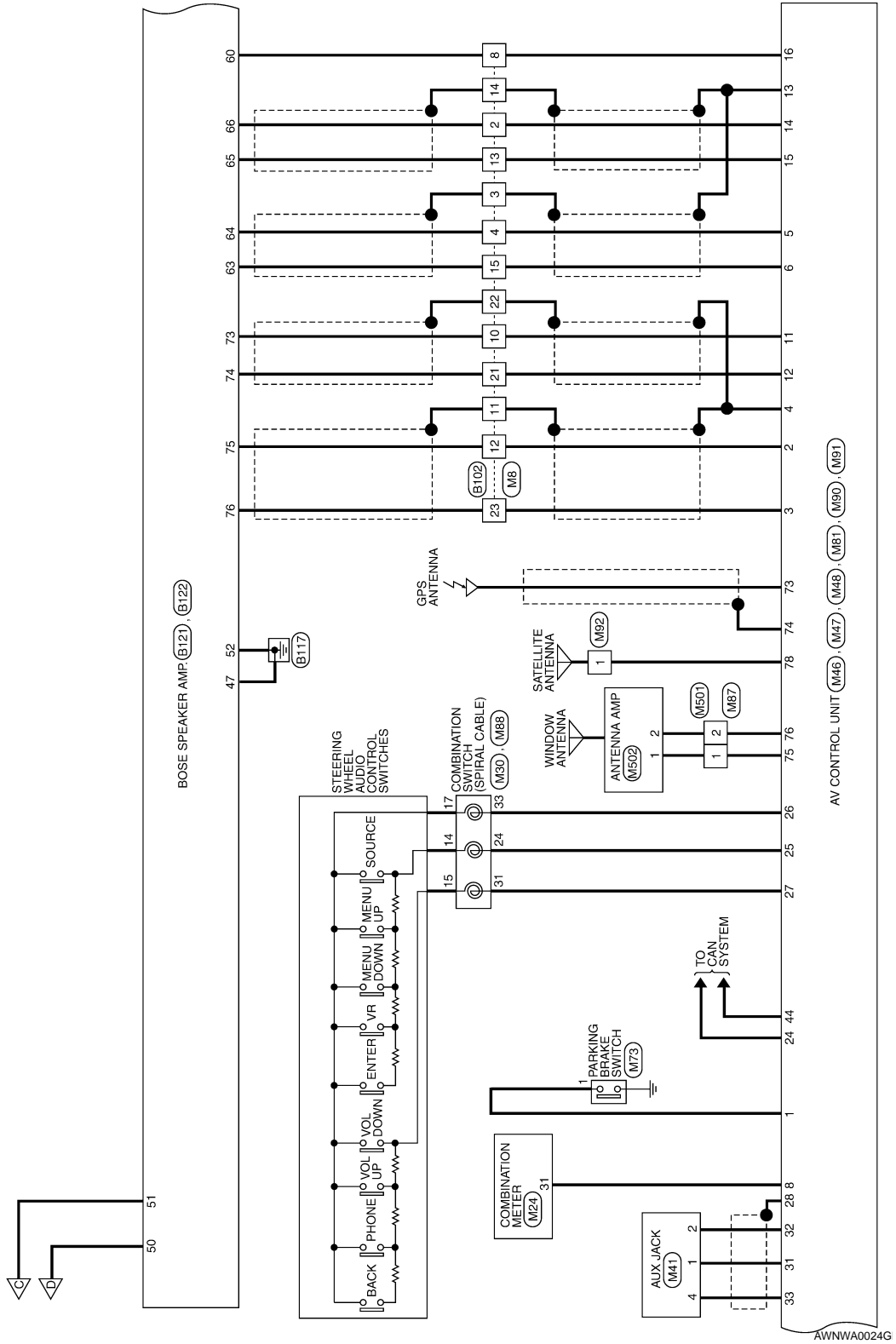

# AV CONTROL UNIT (COUPE)

[BOSE AUDIO WITH NAVIGATION]

< ECU DIAGNOSIS >

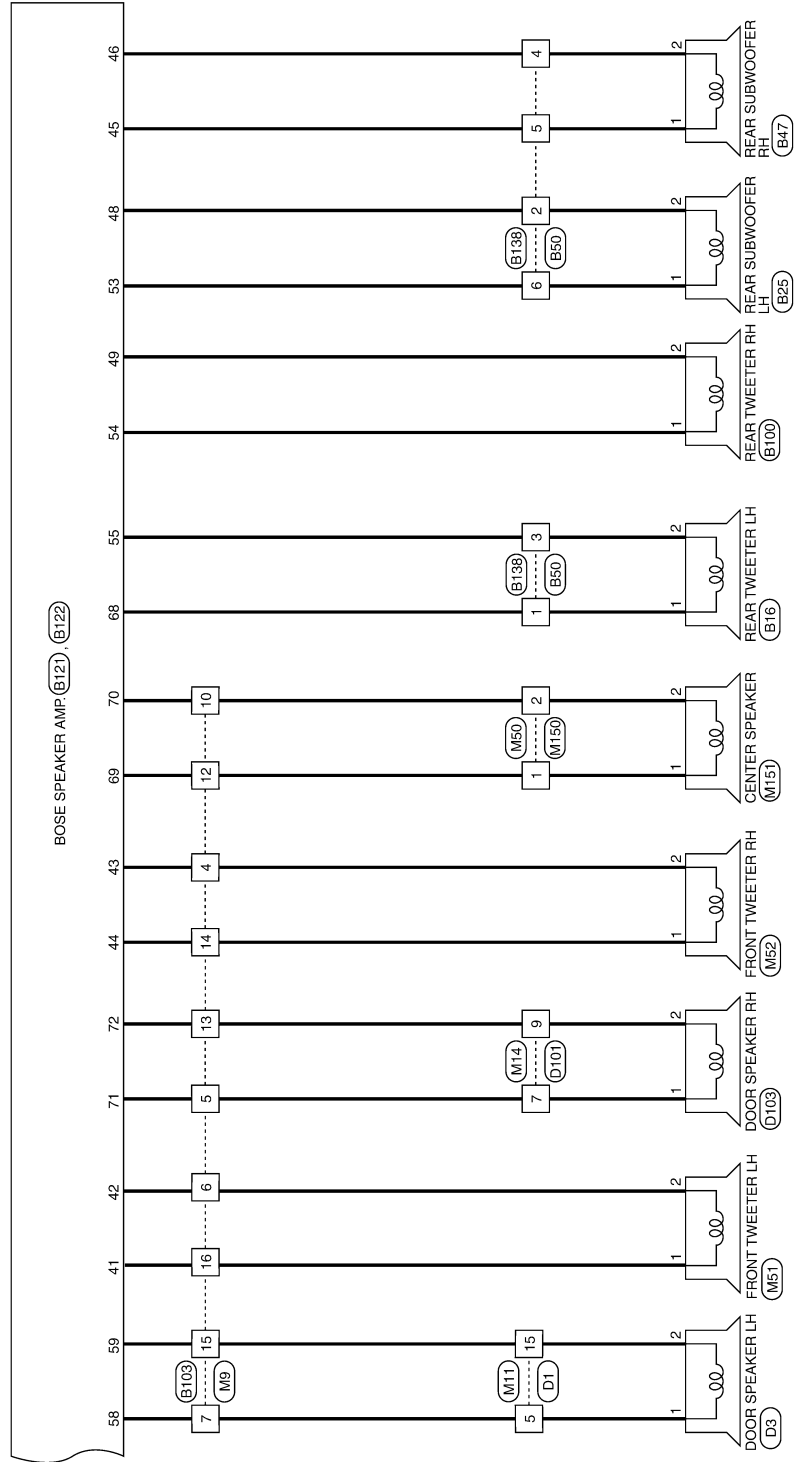

AWNWA0025G

A  
B  
C  
D  
E  
F  
G  
H  
I  
J  
K  
L  
M  
O  
P

AV



# AV CONTROL UNIT (COUPE)

< ECU DIAGNOSIS >

[BOSE AUDIO WITH NAVIGATION]

Connector No.	M9
Connector Name	WIRE TO WIRE
Connector Color	BROWN

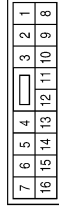

Terminal No.	Color of Wire	Signal Name
1	B/R	-
3	BR/B	-
4	GR/L	-
5	G/W	-
6	B/Y	-
7	W	-
9	B/R	-
10	O/B	-
11	R/G	-
12	B/P	-
13	BR	-
14	L/O	-
15	B	-
16	LG	-

Connector No.	M8
Connector Name	WIRE TO WIRE
Connector Color	WHITE

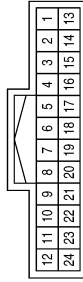

Terminal No.	Color of Wire	Signal Name
2	V	-
3	SHIELD	-
4	GR/V	-
8	B/P	-
10	B	-
11	SHIELD	-
12	G	-
13	LG	-
14	SHIELD	-
15	W/L	-
21	W	-
22	SHIELD	-
23	R	-

Connector No.	M7
Connector Name	WIRE TO WIRE
Connector Color	WHITE



Terminal No.	Color of Wire	Signal Name
1	B/R	-
2	R/B	-
3	R/L	-
4	SHIELD	-

Connector No.	M22
Connector Name	DATA LINK CONNECTOR
Connector Color	WHITE



Terminal No.	Color of Wire	Signal Name
7	O	K-LINE

Connector No.	M14
Connector Name	WIRE TO WIRE
Connector Color	WHITE

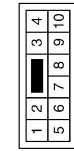

Terminal No.	Color of Wire	Signal Name
7	G/W	-
9	BR	-

Connector No.	M11
Connector Name	WIRE TO WIRE
Connector Color	WHITE

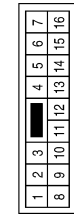

Terminal No.	Color of Wire	Signal Name
5	W	-
15	B	-

ALNIA0036GB

A  
B  
C  
D  
E  
F  
G  
H  
I  
J  
K  
L  
M  
O  
P

AV

# AV CONTROL UNIT (COUPE)

[BOSE AUDIO WITH NAVIGATION]

< ECU DIAGNOSIS >

Connector No.	M24
Connector Name	COMBINATION METER
Connector Color	WHITE

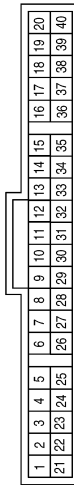

Terminal No.	Color of Wire	Signal Name
31	V/W	8P/R OUT

Connector No.	M30
Connector Name	COMBINATION SWITCH (SPIRAL CABLE)
Connector Color	GRAY

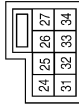

Terminal No.	Color of Wire	Signal Name
24	W/G	AUDIO_STRG_SW_REMOTE_A
31	GR/L	AUDIO_STRG_SW_REMOTE_B
33	L/B	AUDIO_STRG_SW_GND

Connector No.	M41
Connector Name	AUX JACK
Connector Color	WHITE

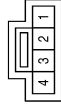

Terminal No.	Color of Wire	Signal Name
1	W/R	AUX_OUT_R
2	SHIELD	-
3	-	-
4	W/L	AUX_OUT_L

Connector No.	M42
Connector Name	CD CHANGER
Connector Color	WHITE

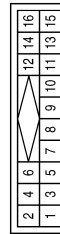

Terminal No.	Color of Wire	Signal Name
1	W/L	N-BUS L-
2	Y/L	N-BUS L+
3	BR/L	N-BUS R-
4	Y/G	N-BUS R+
5	SHIELD	-
6	-	DATA_GND
7	-	-
8	R	REQ
9	B	RX
10	G	TX
12	Y/R	B+
13	R/Y	ILL-
14	R/L	ILL+
16	V/Y	ACC

ALNIA0037GB



# AV CONTROL UNIT (COUPE)

[BOSE AUDIO WITH NAVIGATION]

< ECU DIAGNOSIS >

Connector No.	M46
Connector Name	AV CONTROL UNIT
Connector Color	WHITE



21	22	23	24	25	26	27	28	29	30	31	32	33	34	35	36	37	38	39	40
41	42	43	44	45	46	47	48	49	50	51	52	53	54	55	56	57	58	59	60

Terminal No.	Color of Wire	Signal Name
21	-	-
22	-	-
23	-	-
24	L	V-CAN_H
25	W/G	STRG_SW_SIG_1
26	L/B	STRG_SW_GND
27	GR/L	STRG_SW_SIG_2
28	SHIELD	-

Connector No.	M47
Connector Name	AV CONTROL UNIT
Connector Color	WHITE



1	2	3	4	5	6	7	8	9
10	11	12	13	14	15	16	17	18
19	20							

Terminal No.	Color of Wire	Signal Name
1	G/R	PKB
2	G	FR_LH +
3	R	FR_LH -
4	SHIELD	-
5	GR/V	RR_LH +
6	W/L	RR_LH -

Terminal No.	Color of Wire	Signal Name
29	-	-
30	-	-
31	W/R	AUX_IN_R
32	SHIELD	-
33	W/L	AUX_IN_L
34	W	COMP_IN +
35	SHIELD	-
36	-	-
37	-	-
38	-	-
39	-	-
40	-	-
41	-	-
42	-	-
43	-	-
44	P	V-CAN_L

Terminal No.	Color of Wire	Signal Name
45	B/R	MIC_IN+
46	R/L	MIC_+B
47	R/B	MIC_GND
48	SHIELD	-
49	-	-
50	-	-
51	-	-
52	-	-
53	V/G	RV_CAM_SIG
54	-	-
55	R	COMP_IN-
56	-	-
57	-	-
58	-	-
59	-	-
60	-	-

Terminal No.	Color of Wire	Signal Name
7	V/Y	ACC
8	V/W	SPEED (8P)
9	R/L	ILL
10	G	IGN
11	B	FR_RH +
12	W	FR_RH -
13	SHIELD	-
14	V	RR_RH +
15	LG	RR_RH -
16	B/P	AMP_ON
17	P/B	RV
18	R/Y	ILL_CONT
19	B	GND
20	Y/R	B+

AWNIA0345GB

A  
B  
C  
D  
E  
F  
G  
H  
I  
J  
K  
L  
M  
N  
O  
P

AV

# AV CONTROL UNIT (COUPE)

[BOSE AUDIO WITH NAVIGATION]

< ECU DIAGNOSIS >

Connector No.	M51
Connector Name	FRONT TWEETER LH
Connector Color	BROWN



Terminal No.	Color of Wire	Signal Name
1	LG	-
2	B/Y	-

Connector No.	M50
Connector Name	WIRE TO WIRE
Connector Color	WHITE



Terminal No.	Color of Wire	Signal Name
1	B/P	-
2	O/B	-

Connector No.	M48
Connector Name	AV CONTROL UNIT
Connector Color	GRAY



Terminal No.	Color of Wire	Signal Name
61	W/L	N-BUS_L -
62	Y/L	N-BUS_L +
63	BR/L	N-BUS_R -
64	Y/G	N-BUS_R +
65	SHIELD	-
66	-	DATA_GND
67	-	-
68	-	-
69	B	RX
70	G	TX
71	-	-
72	R	REQ2

Connector No.	M64
Connector Name	JOINT CONNECTOR-M01
Connector Color	GRAY

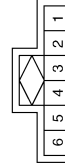

Terminal No.	Color of Wire	Signal Name
1	B	-
2	B	-

Connector No.	M63
Connector Name	JOINT CONNECTOR-M02
Connector Color	BLUE

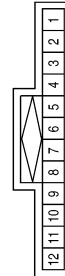

Terminal No.	Color of Wire	Signal Name
8	B	-
10	GR	-

Connector No.	M52
Connector Name	FRONT TWEETER RH
Connector Color	BROWN



Terminal No.	Color of Wire	Signal Name
1	L/O	-
2	GR/L	-

AWNIA0346GB

# AV CONTROL UNIT (COUPE)

[BOSE AUDIO WITH NAVIGATION]

< ECU DIAGNOSIS >

Connector No.	M87
Connector Name	WIRE TO WIRE
Connector Color	GRAY

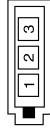

Terminal No.	Color of Wire	Signal Name
1	B	-
2	B	-

Connector No.	M81
Connector Name	AV CONTROL UNIT
Connector Color	GRAY



Terminal No.	Color of Wire	Signal Name
75	B	AMP SUPPLY
76	B	MAIN ANTENNA
77	-	-

Connector No.	M73
Connector Name	PARKING BRAKE SWITCH
Connector Color	BLACK



Terminal No.	Color of Wire	Signal Name
1	G/R	-

Connector No.	M91
Connector Name	AV CONTROL UNIT
Connector Color	BROWN (WITH SIRIUS SATELLITE RADIO) VIOLET (WITH XM SATELLITE RADIO)



Terminal No.	Color of Wire	Signal Name
78	B	-

Connector No.	M90
Connector Name	AV CONTROL UNIT
Connector Color	GRAY



Terminal No.	Color of Wire	Signal Name
73	B	-
74	B	-

Connector No.	M88
Connector Name	COMBINATION SWITCH (SPIRAL CABLE)
Connector Color	GRAY

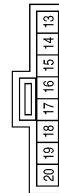

Terminal No.	Color of Wire	Signal Name
14	W	REMOTE A
15	L	REMOTE B
17	BR	GND

AWNIA0363GB

A  
B  
C  
D  
E  
F  
G  
H  
I  
J  
K  
L  
M  
N  
O  
P

AV

# AV CONTROL UNIT (COUPE)

< ECU DIAGNOSIS >

[BOSE AUDIO WITH NAVIGATION]

Connector No.	M151
Connector Name	CENTER SPEAKER
Connector Color	BROWN



Terminal No.	Color of Wire	Signal Name
1	B/P	-
2	O/B	-

Connector No.	M150
Connector Name	WIRE TO WIRE
Connector Color	WHITE



Terminal No.	Color of Wire	Signal Name
1	B/P	-
2	O/B	-

Connector No.	M92
Connector Name	SATELLITE RADIO ANTENNA
Connector Color	GRAY (WITH SIRIUS SATELLITE RADIO) BROWN (WITH XM SATELLITE RADIO)



Terminal No.	Color of Wire	Signal Name
1	B	-

Connector No.	E3
Connector Name	WIRE TO WIRE
Connector Color	WHITE

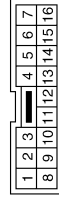

Terminal No.	Color of Wire	Signal Name
4	G/B	-

Connector No.	M502
Connector Name	ANTENNA AMP
Connector Color	GRAY

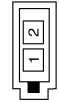

Terminal No.	Color of Wire	Signal Name
1	B	-
2	B	-

Connector No.	M501
Connector Name	WIRE TO WIRE
Connector Color	GRAY



Terminal No.	Color of Wire	Signal Name
1	B	-
2	B	-

Connector No.	E29
Connector Name	WIRE TO WIRE
Connector Color	WHITE



Terminal No.	Color of Wire	Signal Name
15	P/B	-

Connector No.	E11
Connector Name	WIRE TO WIRE
Connector Color	WHITE

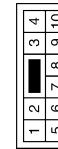

Terminal No.	Color of Wire	Signal Name
3	O	-
8	P/B	-

ALNIA0065GB

# AV CONTROL UNIT (COUPE)

[BOSE AUDIO WITH NAVIGATION]

< ECU DIAGNOSIS >

Connector No.	E34
Connector Name	BACK-UP LAMP RELAY
Connector Color	BLUE



Terminal No.	Color of Wire	Signal Name
1	O/B	-
2	G/B	-
3	P/B	-
5	O	-

Terminal No.	Color of Wire	Signal Name
13G	O	-
55G	B/R	-
54G	BR	-
64G	Y/R	-

Connector No.	E30
Connector Name	WIRE TO WIRE
Connector Color	WHITE

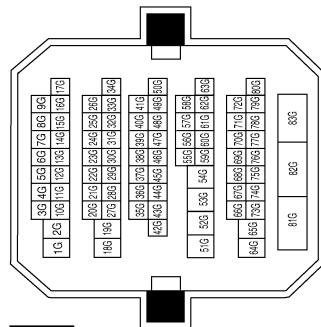

Connector No.	E49
Connector Name	JUNCTION BLOCK
Connector Color	BROWN

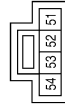

Terminal No.	Color of Wire	Signal Name
51	O	-
52	O/B	-

Connector No.	E47
Connector Name	JUNCTION BLOCK
Connector Color	WHITE

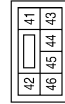

Terminal No.	Color of Wire	Signal Name
45	O	-

A  
B  
C  
D  
E  
F  
G  
H  
I  
J  
K  
L  
M  
AV  
O  
P

# AV CONTROL UNIT (COUPE)

[BOSE AUDIO WITH NAVIGATION]

< ECU DIAGNOSIS >

Connector No.	F16
Connector Name	TCM (TRANSMISSION CONTROL MODULE)
Connector Color	BLACK

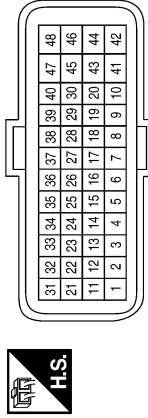

Terminal No.	Color of Wire	Signal Name
19	G/B	REV LAMP RLY

Connector No.	F2
Connector Name	WIRE TO WIRE
Connector Color	WHITE

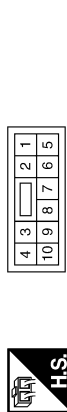

Terminal No.	Color of Wire	Signal Name
3	O	-
8	P/B	-

Connector No.	F1
Connector Name	WIRE TO WIRE
Connector Color	WHITE

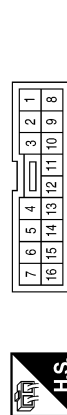

Terminal No.	Color of Wire	Signal Name
4	G/B	-

Connector No.	F49
Connector Name	JOINT CONNECTOR-F03
Connector Color	BLACK



Terminal No.	Color of Wire	Signal Name
3	G/W	-
4	P/B	-

Connector No.	F25
Connector Name	PARK/NEUTRAL POSITION (PNP) SWITCH (WITH QR25DE CVT)
Connector Color	BLACK

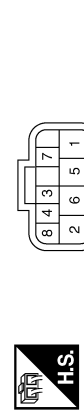

Terminal No.	Color of Wire	Signal Name
3	O	IGN
5	P/B	R_OUTPUT

Connector No.	F24
Connector Name	BACK UP LAMP SWITCH
Connector Color	BLACK

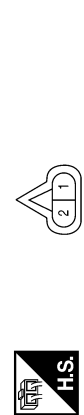

Terminal No.	Color of Wire	Signal Name
1	O	-
2	P/B	-

ALNIA0067GB

# AV CONTROL UNIT (COUPE)

[BOSE AUDIO WITH NAVIGATION]

< ECU DIAGNOSIS >

Connector No.	B6
Connector Name	WIRE TO WIRE
Connector Color	WHITE

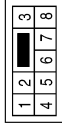

Terminal No.	Color of Wire	Signal Name
1	O/B	-
5	W/R	-

Terminal No.	Color of Wire	Signal Name
10J	GR	-
18J	BR/B	-
19J	R/G	-
84J	P/B	-
85J	SHIELD	-
86J	V/G	-
87J	R	-
88J	W	-
90J	V	-
91J	O	-
92J	Y	-

Connector No.	B1
Connector Name	WIRE TO WIRE
Connector Color	WHITE

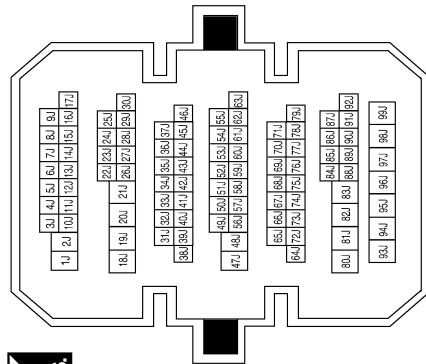

Connector No.	B20
Connector Name	JOINT CONNECTOR-B05
Connector Color	GRAY

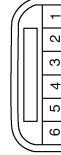

Terminal No.	Color of Wire	Signal Name
3	GR	-
5	GR	-
6	B	-

Connector No.	B16
Connector Name	REAR TWEETER LH
Connector Color	BROWN



Terminal No.	Color of Wire	Signal Name
1	LG	-
2	B/Y	-

Connector No.	B10
Connector Name	WIRE TO WIRE
Connector Color	WHITE

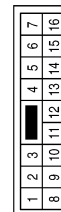

Terminal No.	Color of Wire	Signal Name
15	P/B	-

AWNIA0348GB

A  
B  
C  
D  
E  
F  
G  
H  
I  
J  
K  
L  
M  
N  
O  
P

AV

# AV CONTROL UNIT (COUPE)

[BOSE AUDIO WITH NAVIGATION]

< ECU DIAGNOSIS >

Connector No.	B31
Connector Name	REAR VIEW CAMERA CONTROL UNIT
Connector Color	WHITE

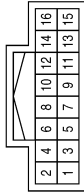

Terminal No.	Color of Wire	Signal Name
1	Y	B +
2	V	ACC
3	B	GND
4	P/B	REV
5	V/G	CONTROL 1
6	O	DDL (K-LINE)
8	GR	CAMERA ON
9	L	CAMERA -
10	P	CAMERA +
11	R	COMP -
12	W	COMP +

Connector No.	B25
Connector Name	REAR SUBWOOFER LH
Connector Color	WHITE



Terminal No.	Color of Wire	Signal Name
1	W/B	-
2	G/B	-

Connector No.	B22
Connector Name	JOINT CONNECTOR-B07
Connector Color	GRAY

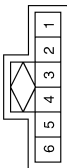

Terminal No.	Color of Wire	Signal Name
1	P/B	-
2	P/B	-
3	P/B	-
5	P/B	-
6	P/B	-

Connector No.	B50
Connector Name	WIRE TO WIRE
Connector Color	WHITE



Terminal No.	Color of Wire	Signal Name
1	R/G	-
2	G/B	-
3	BR/B	-
4	BR	-
5	BR/W	-
6	W/B	-

Connector No.	B48
Connector Name	WIRE TO WIRE
Connector Color	WHITE

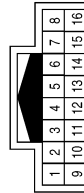

Terminal No.	Color of Wire	Signal Name
10	L	-
11	P	-
12	B	-
13	GR	-

Connector No.	B47
Connector Name	REAR SUBWOOFER RH
Connector Color	WHITE



Terminal No.	Color of Wire	Signal Name
1	BR/W	-
2	BR	-

AWNIA0349GB



# AV CONTROL UNIT (COUPE)

[BOSE AUDIO WITH NAVIGATION]

< ECU DIAGNOSIS >

Terminal No.	Color of Wire	Signal Name
2	LG	-
3	SHIELD	-
4	BR	-
8	B/G	-
10	W/L	-
11	SHIELD	-
12	W/R	-
13	V	-
14	SHIELD	-
15	Y	-
21	GR/V	-
22	SHIELD	-
23	B/R	-

Connector No.	B102
Connector Name	WIRE TO WIRE
Connector Color	WHITE

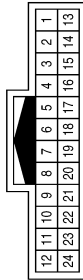

Connector No.	B100
Connector Name	REAR TWEETER RH
Connector Color	BROWN



Terminal No.	Color of Wire	Signal Name
1	L/O	-
2	GR/L	-

Connector No.	B106
Connector Name	WIRE TO WIRE
Connector Color	WHITE

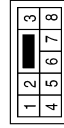

Terminal No.	Color of Wire	Signal Name
1	L	-
5	B/W	-

Terminal No.	Color of Wire	Signal Name
1	BR	-
3	BR/B	-
4	GR/L	-
5	G/W	-
6	B/Y	-
7	W	-
9	B/R	-
10	O/B	-
11	R/G	-
12	B/P	-
13	BR	-
14	L/O	-
15	B	-
16	LG	-

Connector No.	B103
Connector Name	WIRE TO WIRE
Connector Color	BROWN

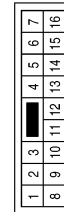

AWNIA0350GB

A  
B  
C  
D  
E  
F  
G  
H  
I  
J  
K  
L  
M  
O  
P

AV

# AV CONTROL UNIT (COUPE)

[BOSE AUDIO WITH NAVIGATION]

< ECU DIAGNOSIS >

Connector No.	B138
Connector Name	WIRE TO WIRE
Connector Color	WHITE



Terminal No.	Color of Wire	Signal Name
1	R/G	-
2	G/B	-
3	BR/B	-
4	BR	-
5	BR/W	-
6	W/B	-

Connector No.	B122
Connector Name	BOSE SPEAKER AMP
Connector Color	BROWN

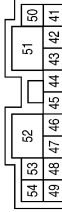

Terminal No.	Color of Wire	Signal Name
41	LG	FR TWDR LH + OUT
42	B/Y	FR TWDR LH - OUT
43	GR/L	FR TWDR RH - OUT
44	L/O	FR TWDR RH + OUT
45	BR/W	RH WOOFER + OUT
46	BR	RH WOOFER - OUT
47	B/L	GND
48	G/B	LH WOOFER - OUT
49	B/W	TWTR RR PSHELF RH-OUT
50	BR	BAT
51	B/R	BAT
52	B	GND
53	W/B	LH WOOFER +OUT
54	L	TWTR RR PSHELF RH +OUT

Connector No.	B121
Connector Name	BOSE SPEAKER AMP
Connector Color	BROWN

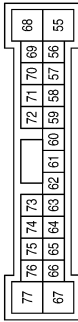

Terminal No.	Color of Wire	Signal Name
55	BR/B	TWTR RR PSHELF LH - OUT
58	W	RR TWDR LH + OUT
59	B	FR TWDR LH - OUT
60	B/G	AMP ON
63	Y	RR LH - IN
64	BR	RR LH + IN
65	V	RR RH - IN
66	LG	RR RH + IN
68	R/G	TWTR RR PSHELF LH + OUT
69	B/P	INST CTR TWDR + OUT
70	O/B	INST CTR TWDR - OUT
71	G/W	FR DOOR RH + OUT
72	BR	FR DOOR RH - OUT
73	W/L	FR RH + IN
74	GR/V	FR RH - IN
75	W/R	FR LH + IN
76	B/R	FR LH - IN

AWNIA0351GB

# AV CONTROL UNIT (COUPE)

[BOSE AUDIO WITH NAVIGATION]

< ECU DIAGNOSIS >

Connector No.	R1
Connector Name	WIRE TO WIRE
Connector Color	WHITE

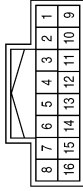

Terminal No.	Color of Wire	Signal Name
1	W	-
2	R	-
3	B	-
4	SHIELD	-

Connector No.	T7
Connector Name	REAR VIEW CAMERA
Connector Color	WHITE

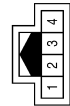

Terminal No.	Color of Wire	Signal Name
1	GR	CAMERA ON
2	B	GND
3	P	COMP +
4	L	COMP -

Connector No.	T1
Connector Name	WIRE TO WIRE
Connector Color	WHITE

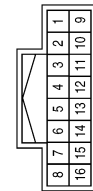

Terminal No.	Color of Wire	Signal Name
10	GR	-
11	Y	-
12	B	-
13	GR	-

Connector No.	D3
Connector Name	DOOR SPEAKER LH
Connector Color	WHITE



Terminal No.	Color of Wire	Signal Name
1	W	-
2	B	-

Connector No.	D1
Connector Name	WIRE TO WIRE
Connector Color	WHITE

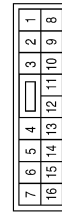

Terminal No.	Color of Wire	Signal Name
5	W	-
15	B	-

Connector No.	R7
Connector Name	MICROPHONE
Connector Color	WHITE

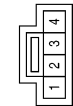

Terminal No.	Color of Wire	Signal Name
1	W	SIG
2	R	GND
4	B	VCC

AWNIA0352GB

A  
B  
C  
D  
E  
F  
G  
H  
I  
J  
K  
L  
M  
N  
O  
P

AV

# AV CONTROL UNIT (COUPE)

< ECU DIAGNOSIS >

[BOSE AUDIO WITH NAVIGATION]

Connector No.	D103
Connector Name	DOOR SPEAKER RH
Connector Color	BROWN



Terminal No.	Color of Wire	Signal Name
1	G/W	-
2	BR	-

Connector No.	D101
Connector Name	WIRE TO WIRE
Connector Color	WHITE

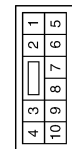

Terminal No.	Color of Wire	Signal Name
7	G/W	-
9	BR	-

AWNIA0362GB

# AV CONTROL UNIT (COUPE)

[BOSE AUDIO WITH NAVIGATION]

< ECU DIAGNOSIS >

## DTC Index

INFOID:000000001830571

CONSULT-III display	Malfunction	Reference page
CAN COMM CIRCUIT [U1000]	When AV control unit is not transmitting or receiving CAN communication signals for 2 seconds or more.	<a href="#">AV-283</a>
CONTROL UNIT (CAN) [U1010]	When a malfunction is detected during initial diagnosis for CAN controller of each control unit.	<a href="#">AV-284</a>
Cont Unit FLASH-ROM [U1200]	An internal malfunction is detected in AV control unit (FLASH-ROM).	<a href="#">AV-285</a>
GYRO NO CONN [U1201]	An internal malfunction is detected in AV control unit (gyrocompass disconnection).	<a href="#">AV-286</a>
GPS COMM [U1204]	An internal malfunction is detected in AV control unit (GPS malfunction).	<a href="#">AV-287</a>
GPS ROM [U1205]	An internal malfunction is detected in AV control unit (GPS malfunction).	<a href="#">AV-288</a>
GPS RAM [U1206]	An internal malfunction is detected in AV control unit (GPS malfunction).	<a href="#">AV-289</a>
GPS RTC [U1207]	An internal malfunction is detected in AV control unit (GPS malfunction).	<a href="#">AV-290</a>
DVD-ROM COMM [U1208]	An internal malfunction is detected in AV control unit (DVD-ROM).	<a href="#">AV-291</a>
DVD-ROM READ [U1209]	An internal malfunction is detected in AV control unit (DVD-ROM).	<a href="#">AV-292</a>
DVD-ROM DISC [U120A]	An internal malfunction is detected in AV control unit (DVD-ROM).	<a href="#">AV-293</a>
DVD-ROM MECHA DETECT [U120C]	An internal malfunction is detected in AV control unit (DVD-ROM).	<a href="#">AV-294</a>
DVD-ROM MECHA [U120D]	An internal malfunction is detected in AV control unit (DVD-ROM).	<a href="#">AV-295</a>
DVD-ROM SEEK [U1210]	An internal malfunction is detected in AV control unit (DVD-ROM).	<a href="#">AV-296</a>
DVD-ROM DATA FORWARD [U1212]	An internal malfunction is detected in AV control unit (DVD-ROM).	<a href="#">AV-297</a>
DVD-ROM DATA [U1213]	An internal malfunction is detected in AV control unit (DVD-ROM).	<a href="#">AV-298</a>
DVD-ROM TIMEOUT [U1214]	An internal malfunction is detected in AV control unit (DVD-ROM).	<a href="#">AV-299</a>
DVD-ROM LOAD [U1215]	An internal malfunction is detected in AV control unit (DVD-ROM).	<a href="#">AV-300</a>
CAN CONT [U1216]	An internal malfunction is detected in AV control unit (CAN controller).	<a href="#">AV-301</a>
BLUETOOTH CONN [U1217]	An internal malfunction is detected in AV control unit (Bluetooth module connection malfunction).	<a href="#">AV-302</a>
XM SERIAL COMM [U1220]	An internal malfunction is detected in AV control unit (satellite radio tuner communication malfunction).	<a href="#">AV-303</a>

A  
B  
C  
D  
E  
F  
G  
H  
I  
J  
K  
L  
M  
AV  
O  
P

# AV CONTROL UNIT (COUPE)

[BOSE AUDIO WITH NAVIGATION]

< ECU DIAGNOSIS >

CONSULT-III display	Malfunction	Reference page
GPS ANTENNA CONN [U1244]	GPS antenna connection malfunction is detected.	<a href="#">AV-304</a>
N-BUS CD CHG CONN [U124C]	<ul style="list-style-type: none"><li>• A malfunction is detected in CD changer power supply and ground circuits</li><li>• Malfunction occurs in request signal circuit. (Between CD changer and AV control unit)</li><li>• Malfunction occurs in communication signal circuit. (Between CD changer and AV control unit)</li></ul>	<a href="#">AV-305</a>

# AV CONTROL UNIT (SEDAN)

< ECU DIAGNOSIS >

[BOSE AUDIO WITH NAVIGATION]

## AV CONTROL UNIT (SEDAN)

### Reference Value

INFOID:000000003214813

### VALUES ON THE DIAGNOSIS TOOL

CONSULT-III data monitor item

Display Item	Display	Vehicle status	Remarks
VHCL SPD SIG	ON	Vehicle speed > 0 km/h (0 MPH)	Changes in indication may be delayed. This is normal.
	OFF	Vehicle speed = 0 km/h (0 MPH)	
PKB SIG	ON	Parking brake is applied.	
	OFF	Parking brake is released.	
ILLUM SIG	ON	Block the light beam from the auto light optical sensor when the light SW is ON .	—
	OFF	Expose the auto light optical sensor to light when the light SW is OFF or ON.	
IGN SIG	ON	Ignition switch ON	
	OFF	Ignition switch in ACC position	
REV SIG	ON	Selector lever in R position	Changes in indication may be delayed. This is normal.
	OFF	Selector lever in any position other than R	

### TERMINAL LAYOUT

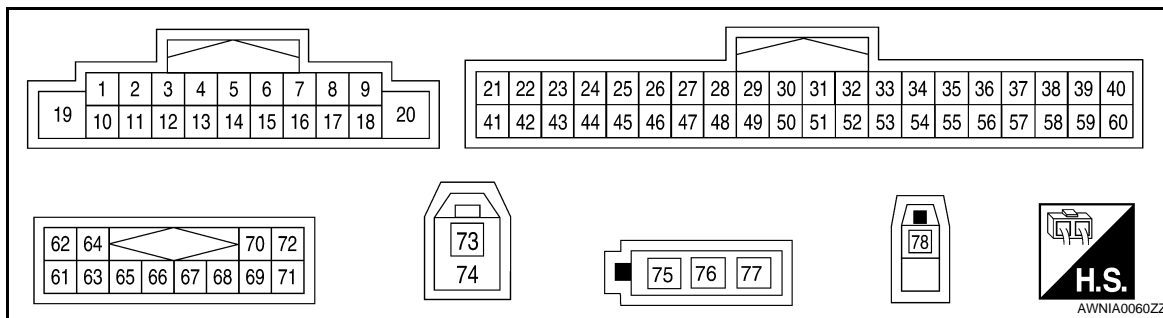

### PHYSICAL VALUES

Terminal (Wire color)		Description		Condition		Reference value (Approx.)
+	-	Signal name	Input/Output	Ignition switch	Operation	
1 (G/R)	Ground	Parking brake signal	Input	Ignition switch ON	Parking brake ON	0V
					Parking brake OFF	Battery voltage
2 (G)	3 (R)	Sound signal front LH	Output	Ignition switch ON	—	
4	—	Shield	—	—	—	—

# AV CONTROL UNIT (SEDAN)

[BOSE AUDIO WITH NAVIGATION]

< ECU DIAGNOSIS >

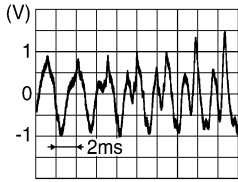
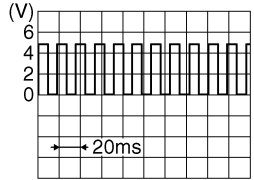
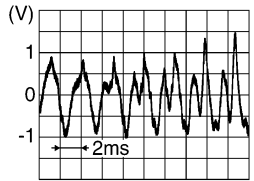
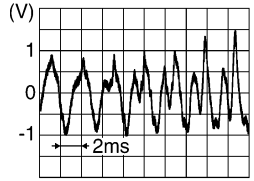
Terminal (Wire color)		Description		Condition		Reference value (Approx.)
+	-	Signal name	Input/ Output	Ignition switch	Operation	
5 (GR/V)	6 (W/L)	Sound signal rear LH	Output	Ignition switch ON	—	 SKIB3609E
7 (V/Y)	Ground	ACC power supply	Input	Ignition switch ACC	—	Battery voltage
8 (V/W)	Ground	Vehicle speed (8-pulse) signal	Input	Ignition switch ON	When vehicle speed is ap- prox. 40 km/h (25MPH)	 SKIA6649J
9 (R/L)	Ground	Illumination signal	Input	OFF	Lighting switch is OFF.	0V
					Lighting switch is ON.	Battery voltage
10 (G)	Ground	Ignition signal	Input	Ignition switch ON	—	Battery voltage
11 (B)	12 (W)	Sound signal front RH	Output	Ignition switch ON	—	 SKIB3609E
13	—	Shield	—	—	—	—
14 (V)	15 (LG)	Sound signal rear RH	Output	Ignition switch ON	—	 SKIB3609E
16 (B/P)	Ground	Amp. ON signal	Output	Ignition switch ON	—	Battery voltage
17 (P/B)	Ground	Reverse signal	Input	Ignition switch ON	R position	Battery voltage
18 (R/Y)	Ground	Illumination control	Input	OFF	—	Refer to <a href="#">INL-10, "System De- scription"</a> .
19 (B)	Ground	Ground	—	Ignition switch ON	—	0V



# AV CONTROL UNIT (SEDAN)

< ECU DIAGNOSIS >

[BOSE AUDIO WITH NAVIGATION]

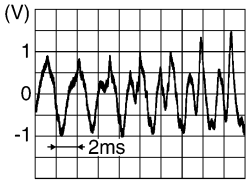
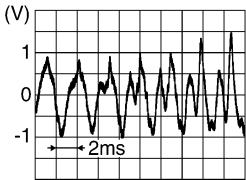
Terminal (Wire color)		Description		Condition		Reference value (Approx.)
+	-	Signal name	Input/ Output	Ignition switch	Operation	
20 (Y/R)	Ground	Battery power supply	Input	Ignition switch OFF	—	Battery voltage
24 (L)	—	CAN-H	Input/ Output	—	—	—
25 (W/G)	26 (L/B)	Steering switch signal 1	Input	Ignition switch ON	Keep pressing SOURCE switch.	0V
					Keep pressing MENU UP switch.	1V
					Keep pressing MENU DOWN switch.	2V
					Keep pressing  switch	3V
					Keep pressing ENTER switch.	4V
					Except for above.	5V
26 (L/B)	Ground	Steering switch signal ground	—	Ignition switch ON	—	0V
27 (GR/L)	26 (L/B)	Steering switch signal 2	Input	Ignition switch ON	Keep pressing VOL DOWN switch.	0V
					Keep pressing VOL UP switch.	1V
					Keep pressing  switch.	2V
					Keep pressing  switch.	3V
					Except for above.	5V
28	—	Shield	—	—	—	—
31 (W/R)	Ground	AUX sound signal RH	Input	Ignition switch ON	When AUX mode is select- ed	
32 (W)	Ground	AUX ground	—	Ignition switch ON	—	0V
33 (W/L)	Ground	AUX sound signal LH	Input	Ignition switch ON	When AUX mode is select- ed	

A  
B  
C  
D  
E  
F  
G  
H  
I  
J  
K  
L  
M  
AV  
O  
P

# AV CONTROL UNIT (SEDAN)

[BOSE AUDIO WITH NAVIGATION]

< ECU DIAGNOSIS >

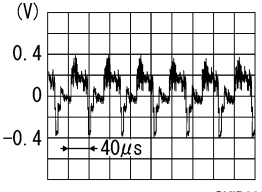
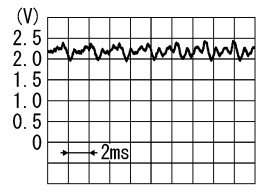
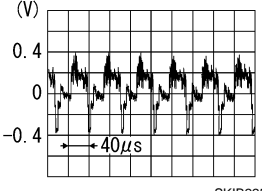
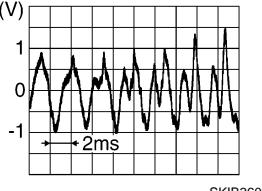
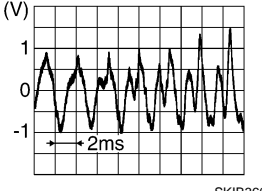
Terminal (Wire color)		Description		Condition		Reference value (Approx.)
+	-	Signal name	Input/ Output	Ignition switch	Operation	
34 (W)	Ground	Camera image signal	Input	Ignition switch ON	Rear view camera image displayed	 <p style="text-align: right; font-size: small;">SKIB2251J</p>
35	—	Shield	—	—	—	—
44 (P)	—	CAN-L	Input/ Output	—	—	—
45 (B/R)	Ground	Microphone signal	Input	Ignition switch ON	—	 <p style="text-align: right; font-size: small;">PKIB5037J</p>
46 (R/L)	Ground	Microphone VCC	Output	Ignition switch ON	—	5V
47 (R/B)	Ground	Microphone ground	—	Ignition switch ON	—	0V
48	—	Shield	—	—	—	—
53 (V/G)	Ground	Camera-connection rec- ognition signal	Input	Ignition switch ON	Connected to camera con- trol unit connector	0V
					Not connected to camera control unit connector	5V
55 (R)	Ground	Camera image signal	Input	Ignition switch ON	Rear view camera image displayed	 <p style="text-align: right; font-size: small;">SKIB2251J</p>
62 (Y/L)	61 (W/L)	CD changer sound sig- nal LH	Input	Ignition switch ON	—	 <p style="text-align: right; font-size: small;">SKIB3609E</p>
64 (Y/G)	63 (BR/L)	CD changer sound sig- nal RH	Input	Ignition switch ON	—	 <p style="text-align: right; font-size: small;">SKIB3609E</p>

# AV CONTROL UNIT (SEDAN)

< ECU DIAGNOSIS >

[BOSE AUDIO WITH NAVIGATION]

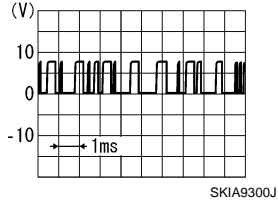
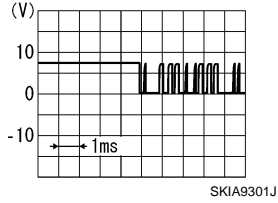
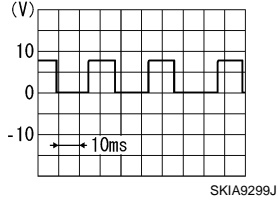
Terminal (Wire color)		Description		Condition		Reference value (Approx.)
+	-	Signal name	Input/ Output	Ignition switch	Operation	
65	—	Shield	—	—	—	—
66	—	Shield	—	—	—	—
69 (B)	Ground	Communication signal (CD→CONT)	Input	Ignition switch ON	—	
70 (G)	Ground	Communication signal (CONT→CD)	Input	Ignition switch ON	—	
72 (R)	Ground	Request signal (CD→CONT)	Output	Ignition switch ON	—	
73 (B)	—	GPS signal	Input	Ignition switch ACC	Not connected to GPS an- tenna connector	5V
74 (B)	—	Shield	—	—	—	—
75 (B)	Ground	Antenna amp. supply	Output	Ignition switch ACC	—	Battery voltage
76 (B)	—	Main antenna	Input	—	—	—
78 (B)	Ground	Satellite antenna signal	Input	Ignition switch ACC	Not connected to satellite antenna connector	5V

A  
B  
C  
D  
E  
F  
G  
H  
I  
J  
K  
L  
M  
O  
P

AV



# AV CONTROL UNIT (SEDAN)

[BOSE AUDIO WITH NAVIGATION]

< ECU DIAGNOSIS >

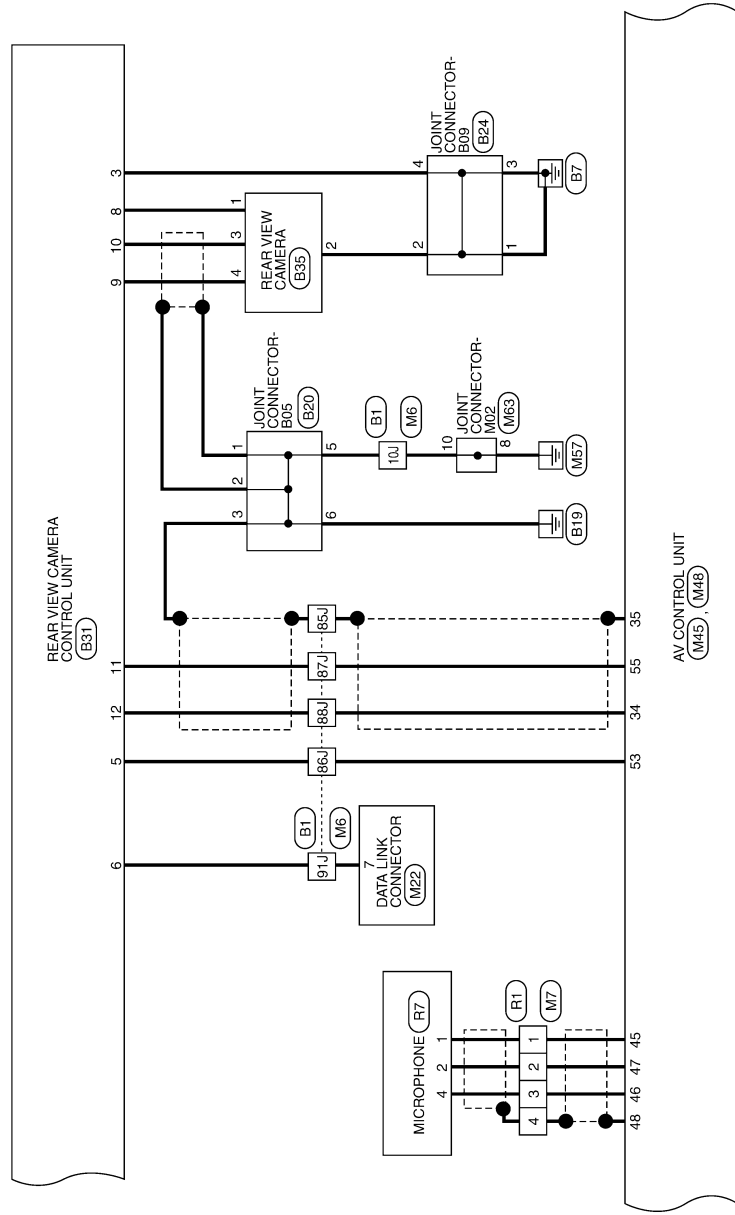
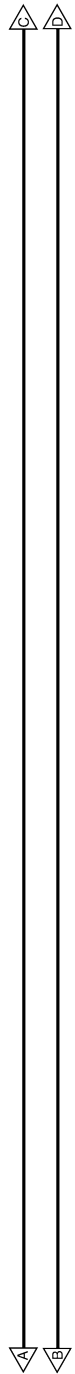

A  
B  
C  
D  
E  
F  
G  
H  
I  
J  
K  
L  
M  
O  
P

AV

AWNWA0123G

# AV CONTROL UNIT (SEDAN)

[BOSE AUDIO WITH NAVIGATION]

< ECU DIAGNOSIS >

M : WITH M/T  
 VT : WITH CVT

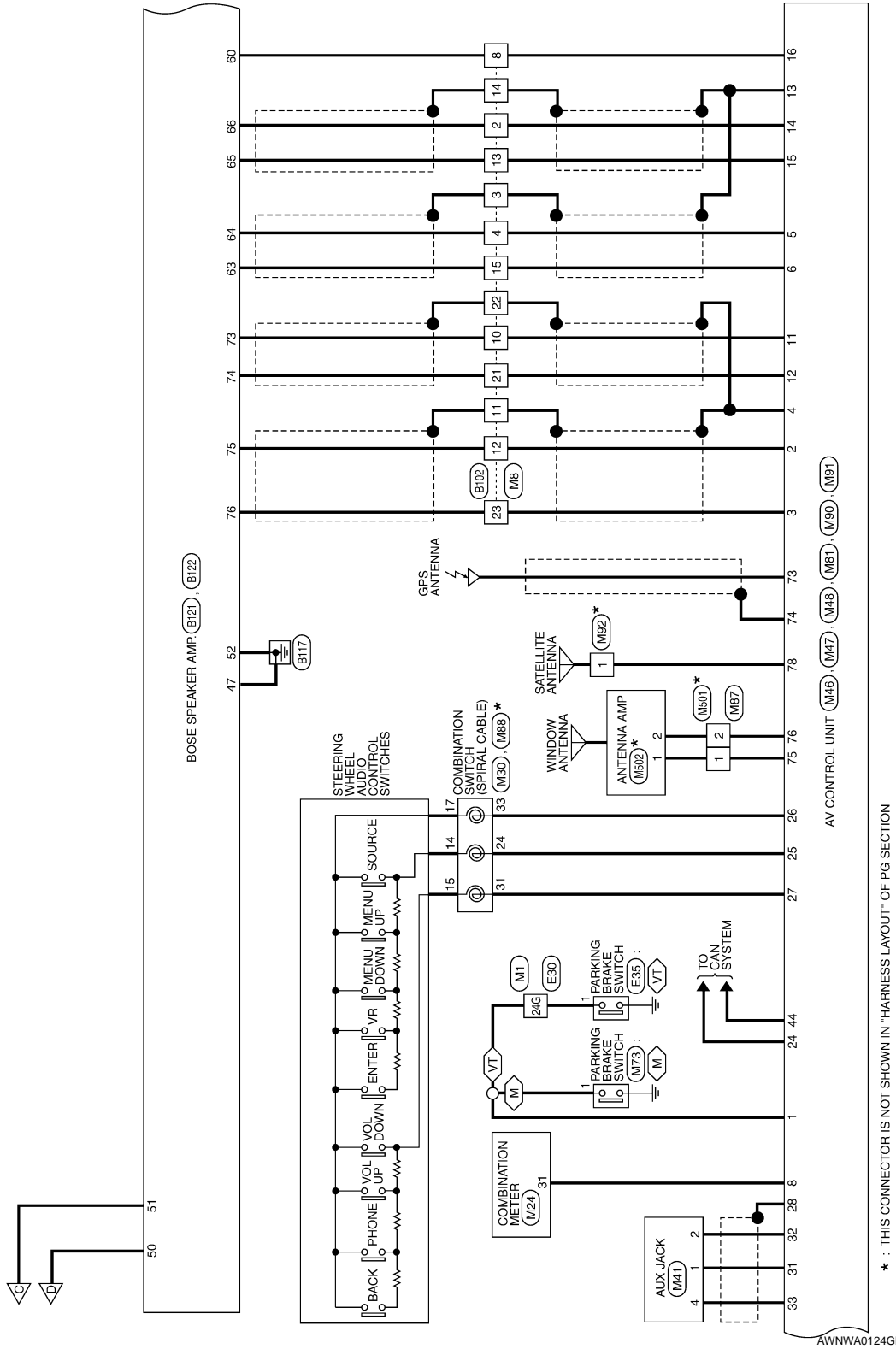

# AV CONTROL UNIT (SEDAN)

[BOSE AUDIO WITH NAVIGATION]

< ECU DIAGNOSIS >

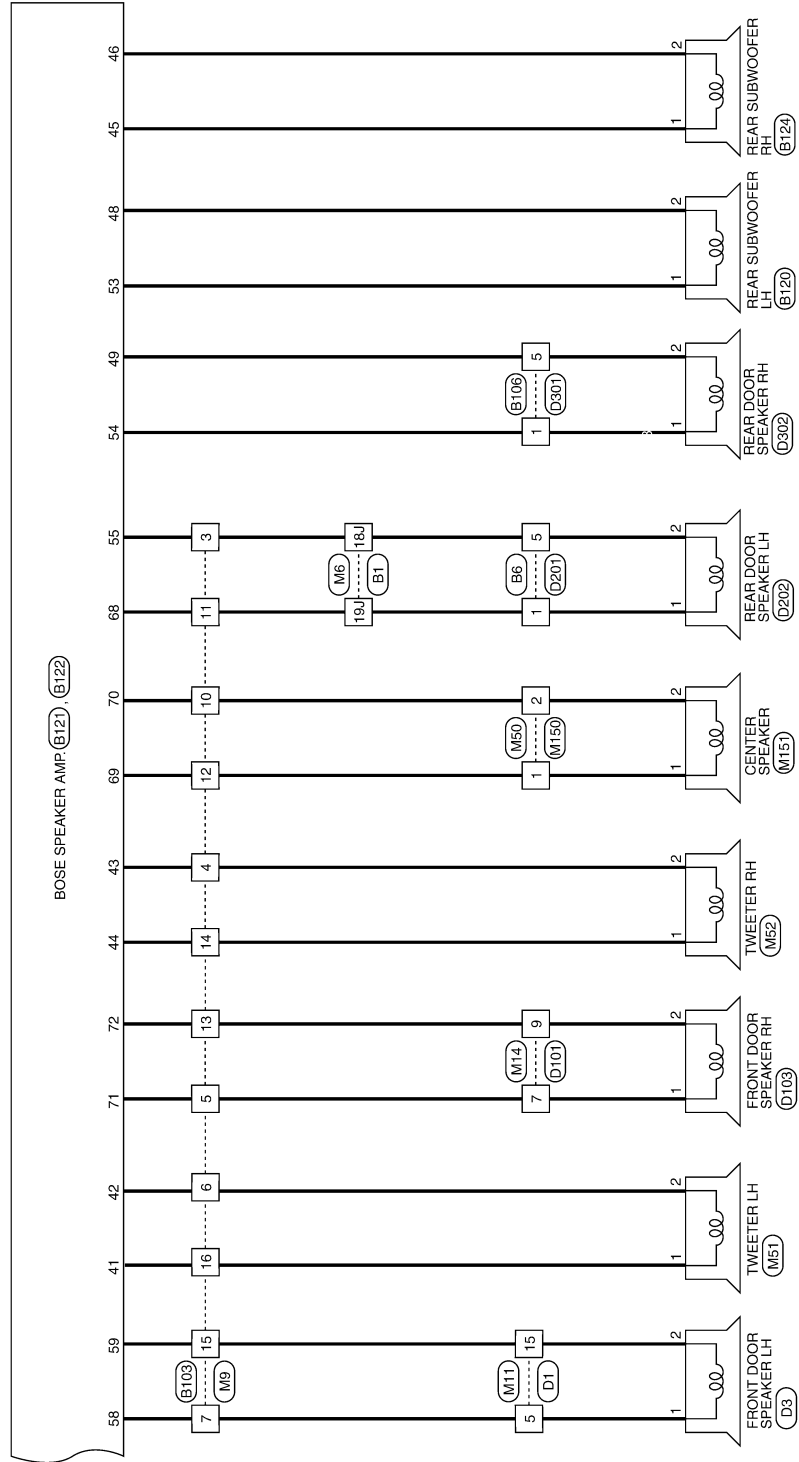

ALNWA0027GE

A  
B  
C  
D  
E  
F  
G  
H  
I  
J  
K  
L  
M  
O  
P

AV

# AV CONTROL UNIT (SEDAN)

[BOSE AUDIO WITH NAVIGATION]

< ECU DIAGNOSIS >

## BOSE AUDIO WITH NAVIGATION SYSTEM CONNECTORS

Connector No.	M1
Connector Name	WIRE TO WIRE
Connector Color	WHITE

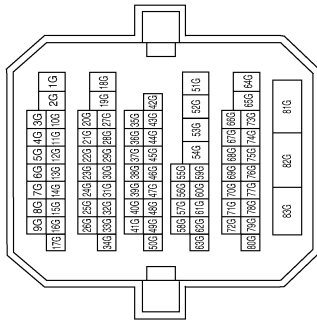

Terminal No.	Color of Wire	Signal Name
13G	O	-
24G	G/R	-
53G	B/R	-
54G	BR	-
64G	Y/R	-

Connector No.	M3
Connector Name	FUSE BLOCK (J/B)
Connector Color	WHITE

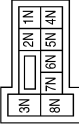

Terminal No.	Color of Wire	Signal Name
2N	G	-
5N	V/Y	-

Connector No.	M5
Connector Name	FUSE BLOCK (J/B)
Connector Color	WHITE

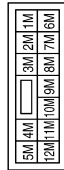

Terminal No.	Color of Wire	Signal Name
12M	P	-

Connector No.	M6
Connector Name	WIRE TO WIRE
Connector Color	WHITE

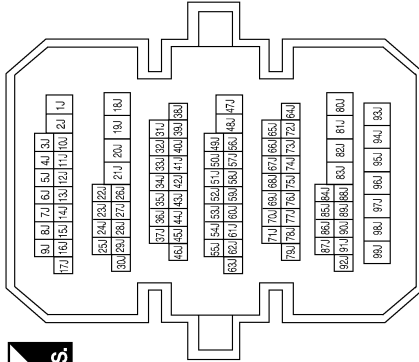

Terminal No.	Color of Wire	Signal Name
10J	GR	-
18J	BR/B	-
19J	R/G	-
84J	P/B	-
85J	SHIELD	-
86J	V/G	-
87J	R	-
88J	W	-
90J	Y/R	-
91J	O	-
92J	V/Y	-

AWNIA0609GB



# AV CONTROL UNIT (SEDAN)

< ECU DIAGNOSIS >

[BOSE AUDIO WITH NAVIGATION]

Connector No.	M9
Connector Name	WIRE TO WIRE
Connector Color	BROWN

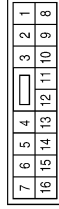

Terminal No.	Color of Wire	Signal Name
1	B/R	-
3	BR/B	-
4	GR/L	-
5	G/W	-
6	B/Y	-
7	W	-
9	B/R	-
10	O/B	-
11	R/G	-
12	B/P	-
13	BR	-
14	L/O	-
15	B	-
16	LG	-

Connector No.	M8
Connector Name	WIRE TO WIRE
Connector Color	WHITE

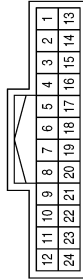

Terminal No.	Color of Wire	Signal Name
2	V	-
3	SHIELD	-
4	GR/V	-
8	B/P	-
10	B	-
11	SHIELD	-
12	G	-
13	LG	-
14	SHIELD	-
15	W/L	-
21	W	-
22	SHIELD	-
23	R	-

Connector No.	M7
Connector Name	WIRE TO WIRE
Connector Color	WHITE

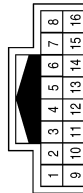

Terminal No.	Color of Wire	Signal Name
1	B/R	-
2	R/B	-
3	R/L	-
4	SHIELD	-

Connector No.	M22
Connector Name	DATA LINK CONNECTOR
Connector Color	WHITE

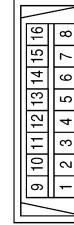

Terminal No.	Color of Wire	Signal Name
7	O	K-LINE

Connector No.	M14
Connector Name	WIRE TO WIRE
Connector Color	WHITE

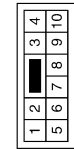

Terminal No.	Color of Wire	Signal Name
7	G/W	-
9	BR	-

Connector No.	M11
Connector Name	WIRE TO WIRE
Connector Color	WHITE

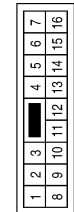

Terminal No.	Color of Wire	Signal Name
5	W	-
15	B	-

ALNIA0036GB

A  
B  
C  
D  
E  
F  
G  
H  
I  
J  
K  
L  
M  
O  
P

AV

# AV CONTROL UNIT (SEDAN)

[BOSE AUDIO WITH NAVIGATION]

< ECU DIAGNOSIS >

Connector No.	M24
Connector Name	COMBINATION METER
Connector Color	WHITE

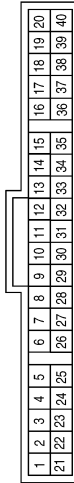

Terminal No.	Color of Wire	Signal Name
31	V/W	8P/R OUT

Connector No.	M30
Connector Name	COMBINATION SWITCH (SPIRAL CABLE)
Connector Color	GRAY

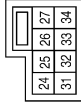

Terminal No.	Color of Wire	Signal Name
24	W/G	AUDIO_STRG_SW_REMOTE_A
31	GR/L	AUDIO_STRG_SW_REMOTE_B
33	L/B	AUDIO_STRG_SW_GND

Connector No.	M41
Connector Name	AUX JACK
Connector Color	WHITE

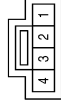

Terminal No.	Color of Wire	Signal Name
1	W/R	AUX_OUT_R
2	SHIELD	-
3	-	-
4	W/L	AUX_OUT_L

Connector No.	M42
Connector Name	CD CHANGER
Connector Color	WHITE

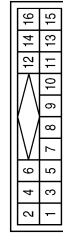

Terminal No.	Color of Wire	Signal Name
1	W/L	N-BUS L-
2	Y/L	N-BUS L+
3	BR/L	N-BUS R-
4	Y/G	N-BUS R+
5	SHIELD	-
6	-	DATA_GND
7	-	-
8	R	REQ
9	B	RX
10	G	TX
12	Y/R	B+
13	R/Y	ILL-
14	R/L	ILL+
16	V/Y	ACC

ALNIA0037GB

# AV CONTROL UNIT (SEDAN)

[BOSE AUDIO WITH NAVIGATION]

< ECU DIAGNOSIS >

Connector No.	M46
Connector Name	AV CONTROL UNIT
Connector Color	WHITE

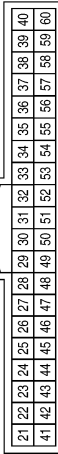

Terminal No.	Color of Wire	Signal Name
21	-	-
22	-	-
23	-	-
24	L	V-CAN_H
25	W/G	STRG_SW_SIG_1
26	L/B	STRG_SW_GND
27	GR/L	STRG_SW_SIG_2
28	SHIELD	-

Terminal No.	Color of Wire	Signal Name
29	-	-
30	-	-
31	W/R	AUX_IN_R
32	SHIELD	-
33	W/L	AUX_IN_L
34	W	COMP_IN +
35	SHIELD	-
36	-	-
37	-	-
38	-	-
39	-	-
40	-	-
41	-	-
42	-	-
43	-	-
44	P	V-CAN_L

Terminal No.	Color of Wire	Signal Name
45	B/R	MIC_IN+
46	R/L	MIC_+B
47	R/B	MIC_GND
48	SHIELD	-
49	-	-
50	-	-
51	-	-
52	-	-
53	V/G	RV_CAM_SIG
54	-	-
55	R	COMP_IN-
56	-	-
57	-	-
58	-	-
59	-	-
60	-	-

Connector No.	M47
Connector Name	AV CONTROL UNIT
Connector Color	WHITE

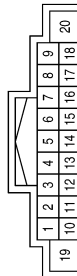

Terminal No.	Color of Wire	Signal Name
1	G/R	PKB
2	G	FR_LH +
3	R	FR_LH -
4	SHIELD	-
5	GR/V	RR_LH +
6	W/L	RR_LH -

Terminal No.	Color of Wire	Signal Name
7	V/Y	ACC
8	V/W	SPEED (8P)
9	R/L	ILL
10	G	IGN
11	B	FR_RH +
12	W	FR_RH -
13	SHIELD	-
14	V	RR_RH +
15	LG	RR_RH -
16	B/P	AMP_ON
17	P/B	RV
18	R/Y	ILL_CONT
19	B	GND
20	Y/R	B+

AWNIA0610GB

A  
B  
C  
D  
E  
F  
G  
H  
I  
J  
K  
L  
M  
N  
O  
P

AV

# AV CONTROL UNIT (SEDAN)

< ECU DIAGNOSIS >

[BOSE AUDIO WITH NAVIGATION]

Connector No.	M51
Connector Name	TWEETER LH
Connector Color	BROWN



Terminal No.	Color of Wire	Signal Name
1	LG	-
2	B/Y	-

Connector No.	M50
Connector Name	WIRE TO WIRE
Connector Color	WHITE



Terminal No.	Color of Wire	Signal Name
1	B/P	-
2	O/B	-

Connector No.	M48
Connector Name	AV CONTROL UNIT
Connector Color	GRAY



Terminal No.	Color of Wire	Signal Name
61	W/L	N-BUS_L -
62	Y/L	N-BUS_L +
63	BR/L	N-BUS_R -
64	Y/G	N-BUS_R +
65	SHIELD	-
66	-	DATA_GND
67	-	-
68	-	-
69	B	RX
70	G	TX
71	-	-
72	R	REQ2

Connector No.	M64
Connector Name	JOINT CONNECTOR-M01
Connector Color	GRAY

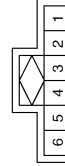

Terminal No.	Color of Wire	Signal Name
1	B	-
2	B	-

Connector No.	M63
Connector Name	JOINT CONNECTOR-M02
Connector Color	BLUE

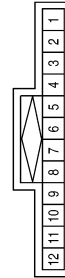

Terminal No.	Color of Wire	Signal Name
8	B	-
10	GR	-

Connector No.	M52
Connector Name	TWEETER RH
Connector Color	BROWN



Terminal No.	Color of Wire	Signal Name
1	L/O	-
2	GR/L	-

ALNIA0039GB

# AV CONTROL UNIT (SEDAN)

< ECU DIAGNOSIS >

[BOSE AUDIO WITH NAVIGATION]

Connector No.	M87
Connector Name	WIRE TO WIRE
Connector Color	GRAY



Terminal No.	Color of Wire	Signal Name
1	B	-
2	B	-

Connector No.	M81
Connector Name	AV CONTROL UNIT
Connector Color	GRAY



Terminal No.	Color of Wire	Signal Name
75	B	AMP SUPPLY
76	B	MAIN ANTENNA
77	-	-

Connector No.	M73
Connector Name	PARKING BRAKE SWITCH (WITH M/F)
Connector Color	BLACK



Terminal No.	Color of Wire	Signal Name
1	G/R	-

Connector No.	M91
Connector Name	AV CONTROL UNIT
Connector Color	VIOLET



Terminal No.	Color of Wire	Signal Name
78	B	-

Connector No.	M90
Connector Name	AV CONTROL UNIT
Connector Color	GRAY



Terminal No.	Color of Wire	Signal Name
73	B	-
74	B	-

Connector No.	M88
Connector Name	COMBINATION SWITCH (SPIRAL CABLE)
Connector Color	GRAY

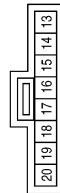

Terminal No.	Color of Wire	Signal Name
14	W	REMOTE A
15	L	REMOTE B
17	BR	GND

AWNIA0611GB

A  
B  
C  
D  
E  
F  
G  
H  
I  
J  
K  
L  
M  
N  
O  
P

AV

# AV CONTROL UNIT (SEDAN)

[BOSE AUDIO WITH NAVIGATION]

< ECU DIAGNOSIS >

Connector No.	M151
Connector Name	CENTER SPEAKER
Connector Color	BROWN



Terminal No.	Color of Wire	Signal Name
1	B/P	-
2	O/B	-

Connector No.	M150
Connector Name	WIRE TO WIRE
Connector Color	WHITE



Terminal No.	Color of Wire	Signal Name
1	B/P	-
2	O/B	-

Connector No.	M92
Connector Name	SATELLITE RADIO ANTENNA
Connector Color	BROWN



Terminal No.	Color of Wire	Signal Name
1	B	-

Connector No.	E3
Connector Name	WIRE TO WIRE
Connector Color	WHITE



Terminal No.	Color of Wire	Signal Name
4	G/B	-

Connector No.	M502
Connector Name	ANTENNA AMP
Connector Color	GRAY

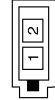

Terminal No.	Color of Wire	Signal Name
1	B	-
2	B	-

Connector No.	M501
Connector Name	WIRE TO WIRE
Connector Color	GRAY



Terminal No.	Color of Wire	Signal Name
1	B	-
2	B	-

Connector No.	E29
Connector Name	WIRE TO WIRE
Connector Color	WHITE



Terminal No.	Color of Wire	Signal Name
15	P/B	-

Connector No.	E11
Connector Name	WIRE TO WIRE
Connector Color	WHITE

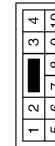

Terminal No.	Color of Wire	Signal Name
3	O	-
8	P/B	-

AWNIA0612GB

# AV CONTROL UNIT (SEDAN)

[BOSE AUDIO WITH NAVIGATION]

< ECU DIAGNOSIS >

Connector No.	E34
Connector Name	BACK-UP LAMP RELAY
Connector Color	BLUE



Terminal No.	Color of Wire	Signal Name
1	O/B	-
2	G/B	-
3	P/B	-
5	O	-

Terminal No.	Color of Wire	Signal Name
13G	O	-
24G	G/R	-
53G	B/R	-
54G	BR	-
64G	Y/R	-

Connector No.	E30
Connector Name	WIRE TO WIRE
Connector Color	WHITE

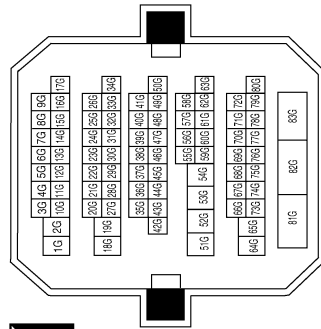

Connector No.	E49
Connector Name	JUNCTION BLOCK
Connector Color	BROWN

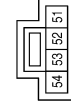

Terminal No.	Color of Wire	Signal Name
51	O	-
52	O/B	-

Connector No.	E47
Connector Name	JUNCTION BLOCK
Connector Color	WHITE

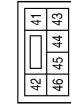

Terminal No.	Color of Wire	Signal Name
45	O	-

Connector No.	E35
Connector Name	PARKING BRAKE SWITCH (WITH CVT)
Connector Color	BLACK



Terminal No.	Color of Wire	Signal Name
1	G/R	-

AWNIA0613GB

A  
B  
C  
D  
E  
F  
G  
H  
I  
J  
K  
L  
M  
AV  
O  
P

# AV CONTROL UNIT (SEDAN)

[BOSE AUDIO WITH NAVIGATION]

< ECU DIAGNOSIS >

Connector No.	F16
Connector Name	TCM (TRANSMISSION CONTROL MODULE)
Connector Color	BLACK

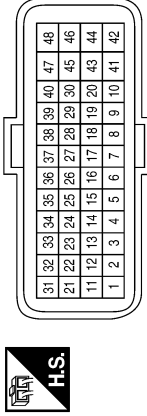

Terminal No.	Color of Wire	Signal Name
19	G/B	REV LAMP RLY

Connector No.	F2
Connector Name	WIRE TO WIRE
Connector Color	WHITE

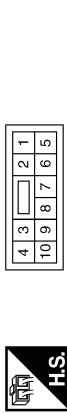

Terminal No.	Color of Wire	Signal Name
3	O	-
8	P/B	-

Connector No.	F1
Connector Name	WIRE TO WIRE
Connector Color	WHITE

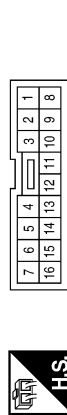

Terminal No.	Color of Wire	Signal Name
4	G/B	-

Connector No.	F49
Connector Name	JOINT CONNECTOR-F03
Connector Color	BLACK



Terminal No.	Color of Wire	Signal Name
3	G/W	-
4	P/B	-

Connector No.	F25
Connector Name	PARK/NEUTRAL POSITION (PNP) SWITCH (WITH QR25DE CVT)
Connector Color	BLACK

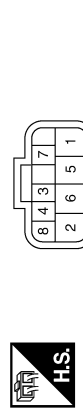

Terminal No.	Color of Wire	Signal Name
3	O	IGN
5	P/B	R_OUTPUT

Connector No.	F24
Connector Name	BACK UP LAMP SWITCH
Connector Color	BLACK



Terminal No.	Color of Wire	Signal Name
1	O	-
2	P/B	-

ALNIA0067GB



# AV CONTROL UNIT (SEDAN)

[BOSE AUDIO WITH NAVIGATION]

< ECU DIAGNOSIS >

Connector No.	B1
Connector Name	WIRE TO WIRE
Connector Color	WHITE

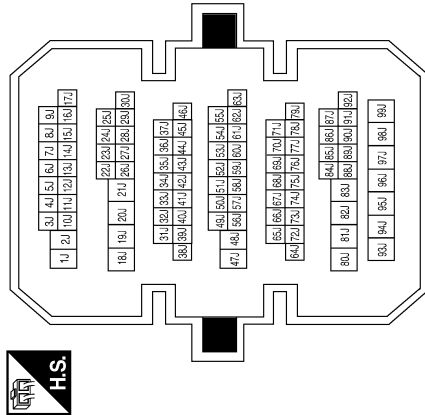

Terminal No.	Color of Wire	Signal Name
10J	GR	-
18J	BR/B	-
19J	R/G	-
84J	P/B	-
85J	SHIELD	-
86J	V/G	-
87J	R	-
88J	W	-
90J	Y	-
91J	O	-
92J	V	-

Connector No.	B6
Connector Name	WIRE TO WIRE
Connector Color	WHITE

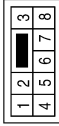

Terminal No.	Color of Wire	Signal Name
1	O/B	-
5	W/R	-

Connector No.	B10
Connector Name	WIRE TO WIRE
Connector Color	WHITE

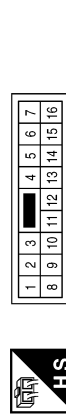

Terminal No.	Color of Wire	Signal Name
15	P/B	-

Connector No.	B20
Connector Name	JOINT CONNECTOR-B05
Connector Color	GRAY

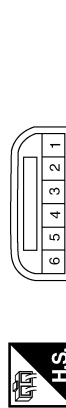

Terminal No.	Color of Wire	Signal Name
1	GR	-
2	GR	-
3	GR	-
5	GR	-
6	B	-

Connector No.	B22
Connector Name	JOINT CONNECTOR-B07
Connector Color	GRAY

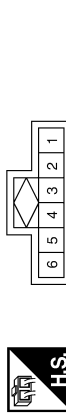

Terminal No.	Color of Wire	Signal Name
1	P/B	-
2	P/B	-
3	P/B	-
5	P/B	-
6	P/B	-

AWNIA0614GB

A  
B  
C  
D  
E  
F  
G  
H  
I  
J  
K  
L  
M  
N  
O  
P

AV

# AV CONTROL UNIT (SEDAN)

[BOSE AUDIO WITH NAVIGATION]

< ECU DIAGNOSIS >

Terminal No.	Color of Wire	Signal Name
1	Y	B +
2	V	ACC
3	B	GND
4	P/B	REV
5	V/G	CONTROL 1
6	O	DDL (K-LINE)
8	GR	CAMERA ON
9	L	CAMERA -
10	P	CAMERA +
11	R	COMP -
12	W	COMP +

Connector No.	B31
Connector Name	REAR VIEW CAMERA CONTROL UNIT
Connector Color	WHITE

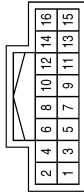

Connector No.	B24
Connector Name	JOINT CONNECTOR-B09
Connector Color	GRAY



Terminal No.	Color of Wire	Signal Name
1	B	-
2	B	-
3	B	-
4	B	-

Terminal No.	Color of Wire	Signal Name
2	LG	-
3	SHIELD	-
4	BR	-
8	B/G	-
10	W/L	-
11	SHIELD	-
12	W/R	-
13	V	-
14	SHIELD	-
15	Y	-
21	GR/V	-
22	SHIELD	-
23	B/R	-

Connector No.	B102
Connector Name	WIRE TO WIRE
Connector Color	WHITE

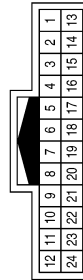

Connector No.	B35
Connector Name	REAR VIEW CAMERA CONTROL UNIT
Connector Color	WHITE

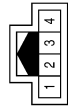

Terminal No.	Color of Wire	Signal Name
1	GR	CAMERA ON
2	B	GND
3	P	COMP +
4	L	COMP -

ALNIA0069GB

# AV CONTROL UNIT (SEDAN)

< ECU DIAGNOSIS >

[BOSE AUDIO WITH NAVIGATION]

Connector No.	B106
Connector Name	WIRE TO WIRE
Connector Color	WHITE

1	2	3
4	5	6
7	8	



Terminal No.	Color of Wire	Signal Name
1	L	-
5	B/W	-

Terminal No.	Color of Wire	Signal Name
1	BR	-
3	BR/B	-
4	GR/L	-
5	G/W	-
6	B/Y	-
7	W	-
9	B/R	-
10	O/B	-
11	R/G	-
12	B/P	-
13	BR	-
14	L/O	-
15	B	-
16	LG	-

Connector No.	B103
Connector Name	WIRE TO WIRE
Connector Color	BROWN

1	2	3	4	5	6	7
8	9	10	11	12	13	14
15	16					



Terminal No.	Color of Wire	Signal Name
55	BR/B	RR DOOR LH - OUT
58	W	RR TWDR LH + OUT
59	B	FR TWDR LH - OUT
60	B/G	AMP ON
63	Y	RR LH - IN
64	BR	RR LH + IN
65	V	RR RH - IN
66	LG	RR RH + IN
68	R/G	RR DOOR LH + OUT
69	B/P	INST CTR TWDR + OUT
70	O/B	INST CTR TWDR - OUT
71	G/W	FR DOOR RH + OUT
72	BR	FR DOOR RH - OUT
73	W/L	FR RH + IN
74	GR/V	FR RH - IN
75	W/R	FR LH + IN
76	B/R	FR LH - IN

Connector No.	B121
Connector Name	BOSE SPEAKER AMP
Connector Color	BROWN

77	76	75	74	73	72	71	70	69	68
67	66	65	64	63	62	61	60	59	58



Connector No.	B120
Connector Name	REAR SPEAKER SUBWOOFER LH
Connector Color	WHITE

2	1
---	---



Terminal No.	Color of Wire	Signal Name
1	W/B	-
2	G/B	-

ALNIA0070GB

A  
B  
C  
D  
E  
F  
G  
H  
I  
J  
K  
L  
M  
N  
O  
P

AV

# AV CONTROL UNIT (SEDAN)

< ECU DIAGNOSIS >

[BOSE AUDIO WITH NAVIGATION]

Connector No.	B124
Connector Name	REAR SUBWOOFER RH
Connector Color	WHITE



Terminal No.	Color of Wire	Signal Name
1	BR/W	-
2	BR	-

Terminal No.	Color of Wire	Signal Name
41	LG	FR TWDR LH + OUT
42	B/Y	FR TWDR LH - OUT
43	GR/L	FR TWDR RH - OUT
44	L/O	FR TWDR RH + OUT
45	BR/W	RH WOOFER + OUT
46	BR	RH WOOFER - OUT
47	B/L	GND
48	G/B	LH WOOFER - OUT
49	B/W	RR DOOR RH - OUT
50	BR	BAT
51	B/R	BAT
52	B	GND
53	W/B	LH WOOFER +OUT
54	L	RR DOOR RH + OUT

Connector No.	B122
Connector Name	BOSE SPEAKER AMP
Connector Color	BROWN

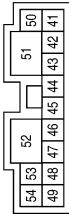

Connector No.	D101
Connector Name	WIRE TO WIRE
Connector Color	WHITE

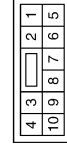

Connector No.	D3
Connector Name	FRONT DOOR SPEAKER LH
Connector Color	WHITE



Connector No.	D1
Connector Name	WIRE TO WIRE
Connector Color	WHITE

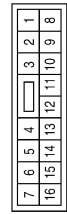

Terminal No.	Color of Wire	Signal Name
7	G/W	-
9	BR	-

Terminal No.	Color of Wire	Signal Name
1	W	-
2	B	-

Terminal No.	Color of Wire	Signal Name
5	W	-
15	B	-

ALNIA0071GB

# AV CONTROL UNIT (SEDAN)

[BOSE AUDIO WITH NAVIGATION]

< ECU DIAGNOSIS >

Connector No.	D202
Connector Name	REAR DOOR SPEAKER LH
Connector Color	BROWN



Terminal No.	Color of Wire	Signal Name
1	O/B	-
2	W/R	-

Connector No.	D201
Connector Name	WIRE TO WIRE
Connector Color	WHITE

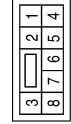

Terminal No.	Color of Wire	Signal Name
1	O/B	-
5	W/R	-

Connector No.	D103
Connector Name	FRONT DOOR SPEAKER RH
Connector Color	BROWN



Terminal No.	Color of Wire	Signal Name
1	G/W	-
2	BR	-

Connector No.	R1
Connector Name	WIRE TO WIRE
Connector Color	WHITE

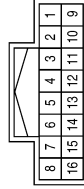

Terminal No.	Color of Wire	Signal Name
1	W	-
2	R	-
3	B	-
4	SHIELD	-

Connector No.	D302
Connector Name	REAR DOOR SPEAKER RH
Connector Color	BROWN



Terminal No.	Color of Wire	Signal Name
1	L	-
2	B/W	-

Connector No.	D301
Connector Name	WIRE TO WIRE
Connector Color	WHITE

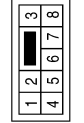

Terminal No.	Color of Wire	Signal Name
1	L	-
5	B/W	-

Terminal No.	Color of Wire	Signal Name
1	W	SIG
2	R	GND
4	B	VCC

Connector No.	R7
Connector Name	MICROPHONE
Connector Color	WHITE

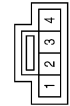

AWNIA0615GB

A  
B  
C  
D  
E  
F  
G  
H  
I  
J  
K  
L  
M  
N  
O  
P

AV

# AV CONTROL UNIT (SEDAN)

**[BOSE AUDIO WITH NAVIGATION]**

< ECU DIAGNOSIS >

## DTC Index

INFOID:00000003214815

CONSULT-III display	Malfunction	Reference page
CAN COMM CIRCUIT [U1000]	When AV control unit is not transmitting or receiving CAN communication signals for 2 seconds or more.	<a href="#">AV-283</a>
CONTROL UNIT (CAN) [U1010]	When a malfunction is detected during initial diagnosis for CAN controller of each control unit.	<a href="#">AV-284</a>
Cont Unit FLASH-ROM [U1200]	An internal malfunction is detected in AV control unit (FLASH-ROM).	<a href="#">AV-285</a>
GYRO NO CONN [U1201]	An internal malfunction is detected in AV control unit (gyrocompass disconnection).	<a href="#">AV-286</a>
GPS COMM [U1204]	An internal malfunction is detected in AV control unit (GPS malfunction).	<a href="#">AV-287</a>
GPS ROM [U1205]	An internal malfunction is detected in AV control unit (GPS malfunction).	<a href="#">AV-288</a>
GPS RAM [U1206]	An internal malfunction is detected in AV control unit (GPS malfunction).	<a href="#">AV-289</a>
GPS RTC [U1207]	An internal malfunction is detected in AV control unit (GPS malfunction).	<a href="#">AV-290</a>
DVD-ROM COMM [U1208]	An internal malfunction is detected in AV control unit (DVD-ROM).	<a href="#">AV-291</a>
DVD-ROM READ [U1209]	An internal malfunction is detected in AV control unit (DVD-ROM).	<a href="#">AV-292</a>
DVD-ROM DISC [U120A]	An internal malfunction is detected in AV control unit (DVD-ROM).	<a href="#">AV-293</a>
DVD-ROM MECHA DETECT [U120C]	An internal malfunction is detected in AV control unit (DVD-ROM).	<a href="#">AV-294</a>
DVD-ROM MECHA [U120D]	An internal malfunction is detected in AV control unit (DVD-ROM).	<a href="#">AV-295</a>
DVD-ROM SEEK [U1210]	An internal malfunction is detected in AV control unit (DVD-ROM).	<a href="#">AV-296</a>
DVD-ROM DATA FORWARD [U1212]	An internal malfunction is detected in AV control unit (DVD-ROM).	<a href="#">AV-297</a>
DVD-ROM DATA [U1213]	An internal malfunction is detected in AV control unit (DVD-ROM).	<a href="#">AV-298</a>
DVD-ROM TIMEOUT [U1214]	An internal malfunction is detected in AV control unit (DVD-ROM).	<a href="#">AV-299</a>
DVD-ROM LOAD [U1215]	An internal malfunction is detected in AV control unit (DVD-ROM).	<a href="#">AV-300</a>
CAN CONT [U1216]	An internal malfunction is detected in AV control unit (CAN controller).	<a href="#">AV-301</a>
BLUETOOTH CONN [U1217]	An internal malfunction is detected in AV control unit (Bluetooth module connection malfunction).	<a href="#">AV-302</a>
XM SERIAL COMM [U1220]	An internal malfunction is detected in AV control unit (satellite radio tuner communication malfunction).	<a href="#">AV-303</a>

# AV CONTROL UNIT (SEDAN)

[BOSE AUDIO WITH NAVIGATION]

< ECU DIAGNOSIS >

CONSULT-III display	Malfunction	Reference page
GPS ANTENNA CONN [U1244]	GPS antenna connection malfunction is detected.	<a href="#">AV-304</a>
N-BUS CD CHG CONN [U124C]	<ul style="list-style-type: none"><li>• A malfunction is detected in CD changer power supply and ground circuits</li><li>• Malfunction occurs in request signal circuit. (Between CD changer and AV control unit)</li><li>• Malfunction occurs in communication signal circuit. (Between CD changer and AV control unit)</li></ul>	<a href="#">AV-305</a>

A

B

C

D

E

F

G

H

I

J

K

L

M

AV

O

P

# BOSE SPEAKER AMP

< ECU DIAGNOSIS >

[BOSE AUDIO WITH NAVIGATION]

## BOSE SPEAKER AMP

Reference Value

INFOID:000000001830572

### TERMINAL LAYOUT

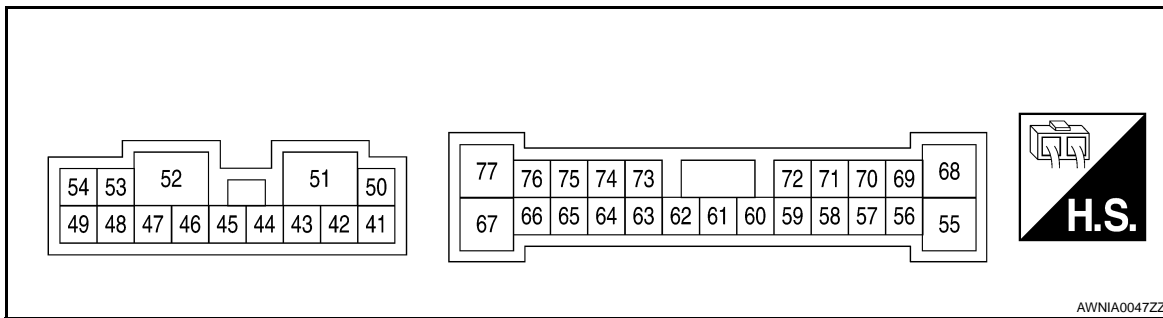

### PHYSICAL VALUES

Terminal (Wire color)		Description		Condition	Reference value (Approx.)
+	-	Signal name	Input/Output		
41 (LG)	42 (B/Y)	Sound signal front tweeter LH	Output	Ignition switch ON	 SKIB3609E
44 (L/O)	43 (GR/L)	Sound signal front tweeter RH	Output	Ignition switch ON	 SKIB3609E
45 (BR/W)	46 (BR)	Sound signal subwoofer RH	Output	Ignition switch ON	 SKIB3609E
47 (B/L)	Ground	GND	—	Ignition switch ON	0V
50 (BR)	Ground	Battery power supply	Input	Ignition switch OFF	Battery voltage
51 (B/R)	Ground	Battery power supply	Input	Ignition switch OFF	Battery voltage
52 (B)	Ground	GND	—	Ignition switch ON	0V



# BOSE SPEAKER AMP

< ECU DIAGNOSIS >

[BOSE AUDIO WITH NAVIGATION]

Terminal (Wire color)		Description		Condition	Reference value (Approx.)
+	-	Signal name	Input/Output		
53 (W/B)	48 (G/B)	Sound signal subwoofer LH	Output	Ignition switch ON	
54 (L)	49 (B/W)	Sound signal rear tweeter RH	Output	Ignition switch ON	
58 (W)	59 (B)	Sound signal door speaker LH	Output	Ignition switch ON	
60 (B/G)	Ground	Amp. ON signal	Input	Ignition switch ACC	Battery voltage
64 (BR)	63 (Y)	Sound signal rear LH	Input	Ignition switch ON	
66 (LG)	65 (V)	Sound signal rear RH	Input	Ignition switch ON	
68 (R/G)	55 (BR/B)	Sound signal rear tweeter LH	Output	Ignition switch ON	

A  
B  
C  
D  
E  
F  
G  
H  
I  
J  
K  
L  
M  
AV  
O  
P

# BOSE SPEAKER AMP

< ECU DIAGNOSIS >

[BOSE AUDIO WITH NAVIGATION]

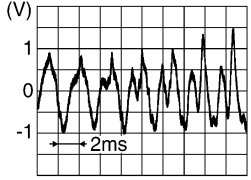
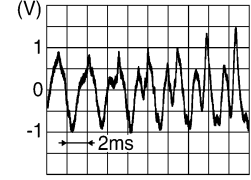
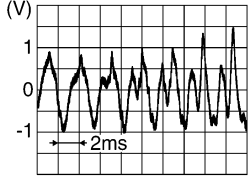
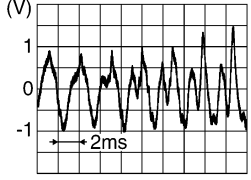
Terminal (Wire color)		Description		Condition	Reference value (Approx.)
+	-	Signal name	Input/Output		
69 (B/P)	70 (O/B)	Sound signal center speaker	Output	Ignition switch ON	
71 (G/W)	72 (BR)	Sound signal door speaker RH	Output	Ignition switch ON	
73 (W/L)	74 (GR/V)	Sound signal front RH	Input	Ignition switch ON	
75 (W/R)	76 (B/R)	Sound signal front LH	Input	Ignition switch ON	

# REAR VIEW CAMERA CONTROL UNIT

[BOSE AUDIO WITH NAVIGATION]

< ECU DIAGNOSIS >

## REAR VIEW CAMERA CONTROL UNIT

Reference Value

INFOID:000000001830573

### TERMINAL LAYOUT

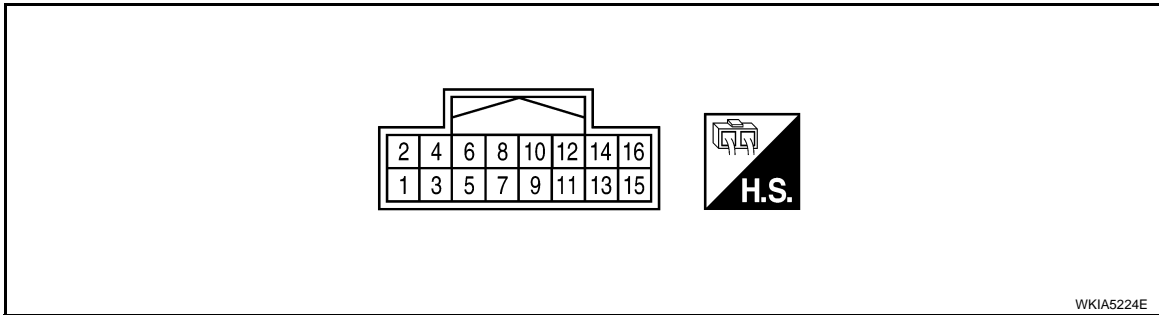

### PHYSICAL VALUES

Terminal (Wire color)		Description		Condition		Reference value (Approx.)
		Signal name	Input/ Output	Ignition switch	Operation	
1 (Y)	Ground	Battery power	Input	OFF	—	Battery voltage
2 (V)	Ground	ACC power	Input	ACC	—	Battery voltage
3 (B)	Ground	Ground	—	ON	—	0V
4 (P/B)	Ground	Reverse signal input	Input	ON	A/T selector lever R position	Battery voltage
					A/T selector lever in other than R position	0V
5 (V/G)	Ground	AV Control	Output	ON	—	0V
6 (O)	Ground	DDL	Output	—	—	—
8 (GR)	Ground	Camera power output	Output	ON	A/T selector lever R position	6V
9 (L)	Ground	Camera image input (-)	Input	ON	—	0V
10 (P)	Ground	Camera image input (+)	Input	ON	A/T selector lever R position	<p>AV</p>

SKIA4894E

# REAR VIEW CAMERA CONTROL UNIT

**[BOSE AUDIO WITH NAVIGATION]**

< ECU DIAGNOSIS >

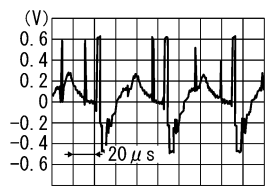
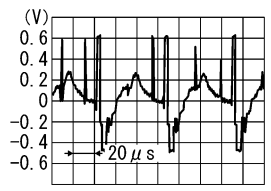
Terminal (Wire color)		Description		Condition		Reference value (Approx.)
		Signal name	Input/ Output	Ignition switch	Operation	
11 (R)	Ground	Composite image output (-)	Output	ON	A/T selector lever R position	 <p style="text-align: right; font-size: small;">SKIA4896E</p>
12 (W)	Ground	Composite image output (+)	Output	ON	A/T selector lever R position	 <p style="text-align: right; font-size: small;">SKIA4896E</p>

# CD CHANGER

< ECU DIAGNOSIS >

[BOSE AUDIO WITH NAVIGATION]

## CD CHANGER

Reference Value

INFOID:000000001830574

### TERMINAL LAYOUT

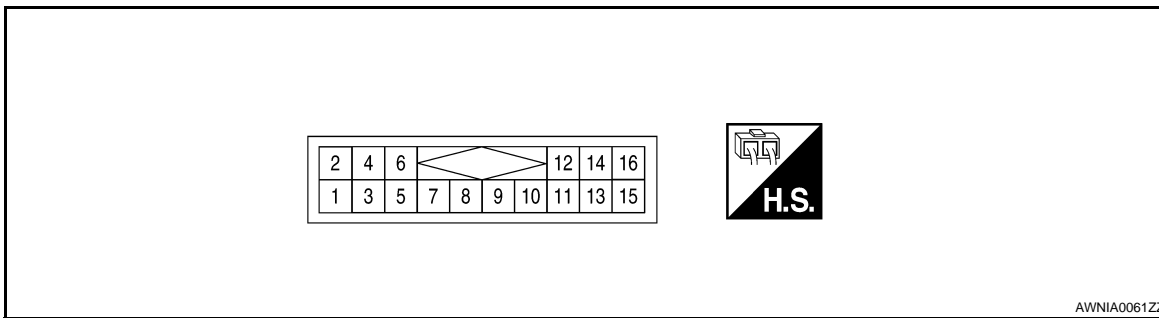

### PHYSICAL VALUES

Terminal (Wire color)		Description	Condition			Reference value (Approx.)
+	-	Signal name	Input/ Output	Ignition switch	Operation	
2 (Y/L)	1 (W/L)	CD changer sound signal LH	Output	Ignition switch ON	When CD change mode is selected	<p>SKIB3609E</p>
4 (Y/G)	3 (BR/L)	CD changer sound signal RH	Output	Ignition switch ON	When CD change mode is selected	<p>SKIB3609E</p>
5	—	Shield	—	—	—	—
6	Ground	Data ground	Input	—	CD player ON	Less than 0.2V
8 (R)	Ground	Request signal (CD→CONT)	Output	Ignition switch ON	When CD change mode is selected	<p>SKIA9299J</p>
9 (B)	Ground	Communication signal (CONT→CD)	Input	Ignition switch ON	When CD change mode is selected	<p>SKIA9300J</p>

A  
B  
C  
D  
E  
F  
G  
H  
I  
J  
K  
L  
M  
O  
P

AV

# CD CHANGER

< ECU DIAGNOSIS >

[BOSE AUDIO WITH NAVIGATION]

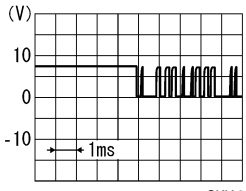
Terminal (Wire color)		Description		Condition		Reference value (Approx.)
+	-	Signal name	Input/ Output	Ignition switch	Operation	
10 (G)	Ground	Communication signal (CD→CONT)	Output	Ignition switch ON	When CD change mode is selected	 <p style="text-align: right; font-size: small;">SKIA9301J</p>
12 (Y/R)	Ground	Battery power supply	Input	Ignition switch OFF	—	Battery voltage
13 (R/Y)	Ground	Illumination (-)	Input	OFF	—	Refer to <a href="#">INL-10, "System Description"</a> .
14 (R/L)	Ground	Illumination (+)	Input	OFF	Lighting switch is OFF.	0V
					Lighting switch is ON.	Battery voltage
16 (V/Y)	Ground	ACC power supply	Input	Ignition switch ACC	—	Battery voltage

# MULTI AV SYSTEM

< SYMPTOM DIAGNOSIS >

[BOSE AUDIO WITH NAVIGATION]

## SYMPTOM DIAGNOSIS

### MULTI AV SYSTEM

#### Symptom Table

INFOID:000000001830575

#### NAVIGATION SYSTEM

Symptom	Possible cause	Reference page
Inoperative	<ul style="list-style-type: none"> <li>AV control unit power and ground circuit</li> <li>AV control unit</li> </ul>	<ul style="list-style-type: none"> <li><a href="#">AV-307</a></li> <li><a href="#">AV-301</a></li> </ul>
Steering switch does not operate	<ul style="list-style-type: none"> <li>Steering wheel audio control switch</li> <li>AV control unit</li> </ul>	<ul style="list-style-type: none"> <li><a href="#">AV-343</a></li> <li><a href="#">AV-301</a></li> </ul>
Voice activated control does not operate	<ul style="list-style-type: none"> <li>Microphone</li> <li>Steering wheel audio control switch</li> <li>AV control unit</li> </ul>	<ul style="list-style-type: none"> <li><a href="#">AV-345</a></li> <li><a href="#">AV-343</a></li> <li><a href="#">AV-301</a></li> </ul>

#### HANDS-FREE PHONE SYSTEM

Symptom	Possible cause	Reference page
Inoperative	<ul style="list-style-type: none"> <li>AV control unit power and ground circuit</li> <li>AV control unit</li> </ul>	<ul style="list-style-type: none"> <li><a href="#">AV-307</a></li> <li><a href="#">AV-301</a></li> </ul>
Steering switch does not operate	<ul style="list-style-type: none"> <li>Steering wheel audio control switch</li> <li>AV control unit</li> </ul>	<ul style="list-style-type: none"> <li><a href="#">AV-343</a></li> <li><a href="#">AV-301</a></li> </ul>
Voice activated control does not operate	<ul style="list-style-type: none"> <li>Microphone</li> <li>Steering wheel audio control switch</li> <li>AV control unit</li> </ul>	<ul style="list-style-type: none"> <li><a href="#">AV-345</a></li> <li><a href="#">AV-343</a></li> <li><a href="#">AV-301</a></li> </ul>

#### REAR VIEW MONITOR

Symptom	Possible cause	Reference page
Inoperative	<ul style="list-style-type: none"> <li>Rear view camera control unit power and ground circuit</li> <li>Reverse signal circuit</li> <li>Camera ON signal circuit</li> <li>Camera image signal circuit (rear view camera to rear view camera control unit)</li> <li>Camera image signal circuit (rear view camera control unit to AV control unit)</li> <li>Rear view camera control unit</li> </ul>	<ul style="list-style-type: none"> <li><a href="#">AV-307</a></li> <li><a href="#">AV-352</a></li> <li><a href="#">AV-349</a></li> <li><a href="#">AV-347</a></li> <li><a href="#">AV-351</a></li> <li><a href="#">AV-347</a></li> </ul>

#### AUDIO SYSTEM

Symptom	Possible cause	Reference page
Inoperative	<ul style="list-style-type: none"> <li>AV control unit power and ground circuit</li> <li>AV control unit</li> </ul>	<ul style="list-style-type: none"> <li><a href="#">AV-307</a></li> <li><a href="#">AV-301</a></li> </ul>
Steering switch does not operate	<ul style="list-style-type: none"> <li>Steering wheel audio control switch</li> <li>AV control unit</li> </ul>	<ul style="list-style-type: none"> <li><a href="#">AV-343</a></li> <li><a href="#">AV-301</a></li> </ul>
All speakers do not sound	<ul style="list-style-type: none"> <li>AV control unit power and ground circuit</li> <li>BOSE speaker amp. ON signal</li> <li>BOSE speaker amp. power and ground circuit</li> <li>BOSE speaker amp.</li> <li>AV control unit</li> </ul>	<ul style="list-style-type: none"> <li><a href="#">AV-307</a></li> <li><a href="#">AV-342</a></li> <li><a href="#">AV-309</a></li> <li><a href="#">AV-342</a></li> <li><a href="#">AV-301</a></li> </ul>
One or several speakers do not sound	<ul style="list-style-type: none"> <li>Door speaker</li> <li>Front tweeter</li> <li>Center speaker</li> <li>Rear tweeter</li> <li>Subwoofer</li> </ul>	<ul style="list-style-type: none"> <li><a href="#">AV-319</a></li> <li><a href="#">AV-325</a></li> <li><a href="#">AV-331</a></li> <li><a href="#">AV-333</a></li> <li><a href="#">AV-339</a></li> </ul>

# NORMAL OPERATING CONDITION

< SYMPTOM DIAGNOSIS >

[BOSE AUDIO WITH NAVIGATION]

## NORMAL OPERATING CONDITION

### Description

INFOID:000000001830576

#### AUDIO SYSTEM

The majority of the audio troubles are the result of outside causes (bad CD, electromagnetic interference, etc.).

#### Noise

The following noise results from variations in field strength, such as fading noise and multi-path noise, or external noise from trains and other sources. It is not a malfunction.

- Fading noise: This noise occurs because of variations in the field strength in a narrow range due to mountains or buildings blocking the signal.
- Multi-path noise: This noise results from the waves sent directly from the broadcast station arriving at the antenna at a different time from the waves which reflect off mountains or buildings.

The vehicle itself can be a source of noise if noise prevention parts or electrical equipment is malfunctioning. Check if noise is caused and/or changed by engine speed, ignition switch turned to each position, and operation of each piece of electrical equipment, and determine the cause.

#### NOTE:

The source of the noise can be found easily by listening to the noise while removing the fuses of electrical components, one by one.

#### Type of Noise and Possible Cause

Occurrence condition		Possible cause
Occurs only when engine is ON.	A continuous growling noise occurs. The speed of the noise varies with changes in the engine speed.	<ul style="list-style-type: none"> <li>• Ignition components</li> </ul>
The occurrence of the noise is linked with the operation of the fuel pump.		<ul style="list-style-type: none"> <li>• Fuel pump condenser</li> </ul>
Noise only occurs when various electrical components are operating.	A cracking or snapping sound occurs with the operation of various switches.	<ul style="list-style-type: none"> <li>• Relay malfunction, audio unit malfunction</li> </ul>
	The noise occurs when various motors are operating.	<ul style="list-style-type: none"> <li>• Motor case ground</li> <li>• Motor</li> </ul>
The noise occurs constantly, not just under certain conditions.		<ul style="list-style-type: none"> <li>• Rear defogger coil malfunction</li> <li>• Open circuit in printed heater</li> <li>• Poor ground of antenna feeder line</li> </ul>
A cracking or snapping sound occurs while the vehicle is being driven, especially when it is vibrating excessively.		<ul style="list-style-type: none"> <li>• Ground wire of body parts</li> <li>• Ground due to improper part installation</li> <li>• Wiring connections or a short circuit</li> </ul>

#### NAVIGATION SYSTEM

##### Basic Operation

Symptom	Cause	Remedy
No image is shown.	Display brightness adjustment is set fully to DARK side.	Adjust the display brightness.
No guide sound is heard. Audio guide volume is too low or too high.	Volume control is set to OFF, MIN or MAX.	Adjust the audio guide volume.
	Audio guidance is not available while the vehicle is driving on a dark pink route.	System is not malfunctioning.
Screen is too dark. Motion of the image is too slow.	Temperature inside the vehicle is low.	Wait until the temperature inside the vehicle reaches the proper temperature.
Small black or bright spots appear on the screen.	Symptom peculiar to a liquid crystal display (display unit).	System is not malfunctioning.

##### Vehicle Mark



## NORMAL OPERATING CONDITION

< SYMPTOM DIAGNOSIS >

[BOSE AUDIO WITH NAVIGATION]

Symptom	Cause	Remedy	
Map screen and BIRDVIEW™ Name of the place vary with the screen.	Some thinning of the character data is done to prevent the display becoming to complex. In some cases and in some locations, the display contents may differ. The same place name, street name, etc. may not be displayed every time on account of the data processing.	System is not malfunctioning.	A
Vehicle mark is not positioned correctly.	Vehicle is transferred by ferry or by towing after its ignition switch is turned to OFF.	Drive the vehicle for a while in the GPS satellite signal receiving condition.	B
Screen will not switch to nighttime mode after the lighting switch is turned ON.	The daytime screen is selected by the "SWITCH SCREENS" when the last time the screen dimming setting is done. Switching between daytime/nighttime screen may be inhibited by the automatic illumination adjustment function.	Perform screen dimming and select the nighttime screen by "SWITCH SCREENS".	C
Map screen will not scroll in accordance with the vehicle travel.	Current location is not displayed.	Press "MAP" button to display the current location.	D
Vehicle mark will not be shown.	Current location is not displayed.	Press "MAP" button to display the current location.	E
Accuracy indicator (GPS satellite mark) on the map screen stays gray.	GPS satellite signal is intercepted because the vehicle is in or behind a building.	Move the vehicle out to an open space.	F
	GPS satellite signal cannot be received because an obstacle is placed on top of the instrument panel.	Do not place anything on top of the meter display (instrument panel).	G
	GPS satellites are not visible from current location.	Wait until GPS satellites are visible by moving the vehicle.	H
Vehicle location accuracy is low.	Accuracy indicator (GPS satellite mark) on the map screen stays gray.	Current location is not determined.	I
	Vehicle speed setting by the vehicle speed pulse has been deviated (advanced or retarded) from the actual vehicle speed because tire chain is fitted or the system has been used on another vehicle.	Drive the vehicle for a while [for approx. 30 minutes at approx. 30 km/h (19 MPH)] and the deviation will be automatically adjusted. If advancement or retard still occur, perform the distance adjustment by CONFIRMATION/ADJUSTMENT mode of diagnosis function.	J
	Map data has error or omission. (Vehicle mark is always deviated to the same position.)	As a rule, an updated map DVD-ROM will be released once a year.	K
<b>Destination, Passing Points and Menu Items Cannot be Selected/Set</b>			

Symptom	Cause	Remedy	
Destination cannot be set.	Destination to be set is on an expressway.	Set the destination on an ordinary road.	L
Passing point is not searched when re-searching the route.	The vehicle has already passed the passing point, or the system judged so.	To include the passing points that have been passed into the route again, set the route again.	M
Route information will not be displayed.	Route searching has not been done.	Set the destination and perform route searching.	N
	Vehicle mark is not on the recommended route.	Drive on the recommended route.	O
	Route guide is turned OFF.	Turn route guide ON.	P
	Route information is not available on the dark pink route.	System is not malfunctioning.	Q
After the route searching, no guide sign will appear as the vehicle goes near the entrance/exit to the toll road.	Vehicle mark is not on the recommended route. (On the display, only guide signs related to the recommended route will be shown.)	Drive on the recommended route.	R

## NORMAL OPERATING CONDITION

< SYMPTOM DIAGNOSIS >

[BOSE AUDIO WITH NAVIGATION]

Symptom	Cause	Remedy
Automatic route searching is not possible.	Vehicle is driving on a highway (gray route), or no recommended route is available.	Drive on a road to be searched. Or re-search the route manually. In this case, however, the whole route will be searched.
Performed automatic detour search (or detour search). However, the result is the same as that of the previous search.	Performed search with every conditions considered. However, the result is the same as that of the previous search.	System is not malfunctioning.
Passing points cannot be set.	More than five passing points were set.	Passing points can be set up to five. To stop at more than five points, perform sharing in several steps.
When setting the route, the starting point cannot be selected.	The current vehicle location is always set as the starting point of a route.	System is not malfunctioning.
Some menu items cannot be selected.	The vehicle is being driven.	Stop the vehicle at a safe place and then operate the system.

### Voice Guide

Symptom	Cause	Remedy
Voice guide will not operate.	Note: Voice guide is only available at intersections that satisfy certain conditions (indicated by ● on the map). Therefore, guidance may not be given even when the route on the map changes direction.	System is not malfunctioning.
	The vehicle is not on the recommended route.	Return to the recommended route or re-search the route.
	Voice guide is turned OFF.	Turn voice guide ON.
	Route guide is turned OFF.	Turn route guide ON.
Voice guide does not match the actual road pattern.	Voice guide may vary with the direction to which the vehicle is turn and the connection of the road to other roads.	Drive in conformity to the actual traffic rules.

### Route Search

Symptom	Cause	Remedy
No route is shown.	No road to be searched is found around the destination.	Find wider road (orange road or wider) nearby and reset the destination and passing points onto it. Take care of the traveling direction when there are separate up and down roads.
	Starting point and the destination are too close.	Set the destination at more distant point.
	Conditional traffic regulation (day of the week/ time of the day) is set at the area around the current location or the destination.	Turn the time-regulating search conditions OFF. Turn "Avoid regulation time" in the search conditions OFF.
Indicated route is intermittent.	In some areas, highways (gray routes) are not used for the search <sup>(Note)</sup> Therefore, the route to the current location or the passing points may be intermittent.	System is not malfunctioning.
When the vehicle has passed the recommended route, it is deleted from the screen.	A recommended route is controlled by each section. When the vehicle has passed the passing point 1, then the map data from the starting point up to the passing point 1 will be deleted. (The data may remain undeleted in some area.)	System is not malfunctioning.

# NORMAL OPERATING CONDITION

< SYMPTOM DIAGNOSIS >

[BOSE AUDIO WITH NAVIGATION]

Symptom	Cause	Remedy
Detouring route is recommended.	In some areas, highways (gray routes) are not used for the search. (Note). Therefore, detour route may be recommended.	Set the route closer to the basic route (gray route).
	A detour route may be shown when some traffic regulation (one-way traffic, etc.) is set at the area around the starting point or the destination.	Slightly move the starting point or the destination, or set the passing point on the route of your choice.
	In the area where highways (gray routes) are used for the search, left turn has priority around the current location and the destination (passing points). For this reason, the recommended route may be detouring.	System is not malfunctioning.
Landmarks on the map do not match the actual ones.	This can be happen due to omission or error in the map data.	As a rule, an updated map DVD-ROM will be released once a year. Wait until the latest map has become available.
Recommended route is far from the starting point, passing points, and destination.	Starting point, passing points, and destination of the route guide were set far from the desired points because route searching data around these area were not stored.	Reset the destination onto the road nearby. If this road is one of the highways (gray routes), an ordinary road nearby may be displayed as the recommended route.

**NOTE:**

Except for the ordinance-designated cities. (Malfunctioning areas may be changed in the updated map disc.)

**Examples of Current-Location Mark Displacement**

Vehicle's travel amount is calculated by reading its travel distance and turning angle. Therefore, if the vehicle is driven in the following manner, an error will occur in the vehicle's current location display. If correct location has not been restored after driving the vehicle for a while, perform location correction.

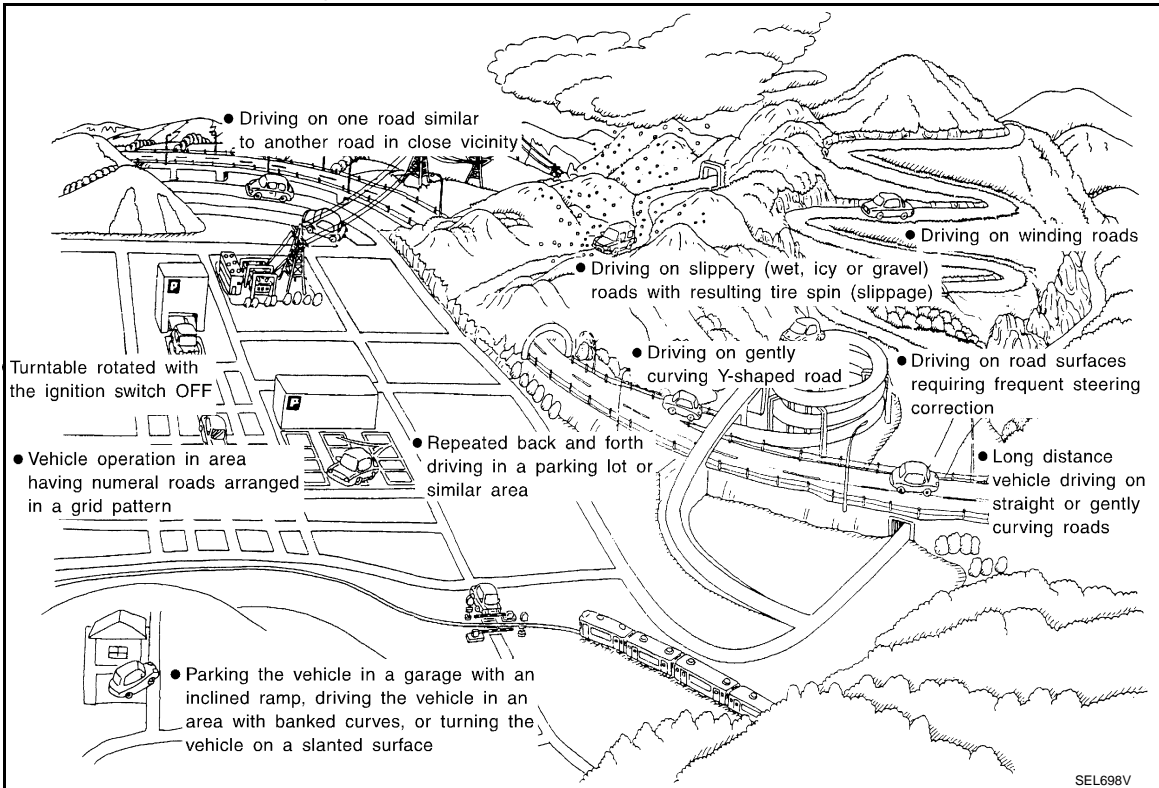

A  
B  
C  
D  
E  
F  
G  
H  
I  
J  
K  
L  
M  
AV  
O  
P

# NORMAL OPERATING CONDITION

< SYMPTOM DIAGNOSIS >

[BOSE AUDIO WITH NAVIGATION]

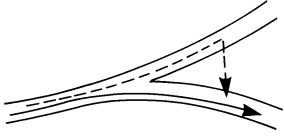
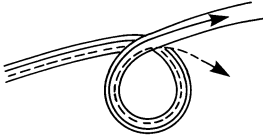
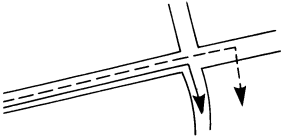
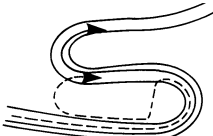
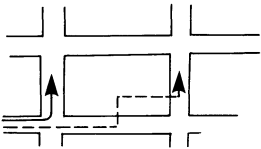
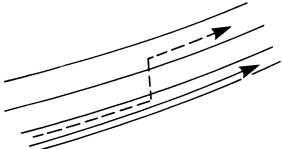
Cause (condition)	-: While driving    ooo: Display	Driving condition	Remarks (correction, etc.)
Road configuration	<p>Y-intersections</p>  <p style="text-align: center; font-size: small;">ELK0192D</p>	<p>At a Y intersection or similar gradual division of roads, an error in the direction of travel deduced by the sensor may result in the current-location mark appearing on the wrong road.</p>	<p>If after travelling about 10 km (6 miles) the correct location has not been restored, perform location correction and, if necessary, direction correction.</p>
	<p>Spiral roads</p>  <p style="text-align: center; font-size: small;">ELK0193D</p>	<p>When driving on a large, continuous spiral road (such as loop bridge), turning angle error is accumulated and the vehicle mark may deviate from the correct location.</p>	
	<p>Straight roads</p>  <p style="text-align: center; font-size: small;">ELK0194D</p>	<p>When driving on a long, straight road and slow curve without stopping, map-matching does not work effectively enough and distance errors may accumulate. As a result, the vehicle mark may deviate from the correct location when the vehicle is turned at a corner.</p>	
	<p>Zigzag roads</p>  <p style="text-align: center; font-size: small;">ELK0195D</p>	<p>When driving on a zigzag road, the map may be matched to other roads in the similar direction nearby at every turn, and the vehicle mark may deviate from the correct location.</p>	
	<p>Roads laid out in a grid pattern</p>  <p style="text-align: center; font-size: small;">ELK0196D</p>	<p>When driving where roads are laid out in a grid pattern, or where many roads are running in the similar direction nearby, the map may be matched to them by mistake and the vehicle mark may deviate from the correct location.</p>	
	<p>Parallel roads</p>  <p style="text-align: center; font-size: small;">ELK0197D</p>	<p>When two roads are running in parallel (such as highway and sideways), the map may be matched to the other road by mistake and the vehicle mark may deviate from the correct location.</p>	

# NORMAL OPERATING CONDITION

< SYMPTOM DIAGNOSIS >

[BOSE AUDIO WITH NAVIGATION]

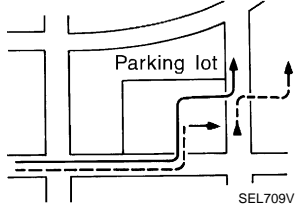
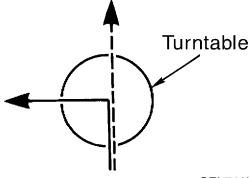
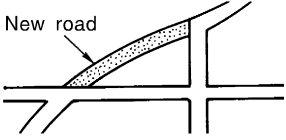
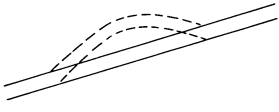
	Cause (condition)    -: While driving    ooo: Display	Driving condition	Remarks (correction, etc.)
Place	In a parking lot  SEL709V	When driving in a parking lot, or other location where there are no roads on the map, matching may place the vehicle mark on a nearby road. When the vehicle returns to the road, the vehicle mark may have deviated from the correct location. When driving in circle or turning the steering wheel repeatedly, direction errors accumulate, and the vehicle mark may deviate from the correct location.	If after travelling about 10 km (6 miles) the correct location has not been restored, perform location correction and, if necessary, direction correction.
	Turntable  SEL710V	When the ignition switch is OFF, the navigation system cannot get the signal from the gyroscope (angular speed sensor). Therefore, the displayed direction may be wrong and the correct road may not be easily returned to after rotating the vehicle on a turntable with the ignition OFF.	
	Slippery roads	On snow, wet roads, gravel, or other roads where tires may slip easily, accumulated mileage errors may cause the vehicle mark to deviate from the correct road.	
	Slopes	When parking in sloped garages, when travelling on banked roads, or in other cases where the vehicle turns when tilted, an error in the turning angle will occur, and the vehicle mark may deviate from the road.	
Map data	Road not displayed on the map screen  SEL699V	When driving on new roads or other roads not displayed on the map screen, map matching does not function correctly and matches the location to a nearby road. When the vehicle returns to a road which is on the map, the vehicle mark may deviate from the correct road.	
	Different road pattern (Changed due to repair)  ELK0201D	If the road pattern stored in the map data and the actual road pattern are different, map matching does not function correctly and matches the location to a nearby road. The vehicle mark may deviate from the correct road.	
Vehicle	Use of tire chains	When tire chains are used, the mileage is not correctly detected, and the vehicle mark may deviate from the correct road.	Drive the vehicle for a while. If the distance still deviates, adjust it by using the distance adjustment function. (If the tire chain is removed, recover the original value.)

A  
B  
C  
D  
E  
F  
G  
H  
I  
J  
K  
L  
M  
AV  
O  
P

# NORMAL OPERATING CONDITION

< SYMPTOM DIAGNOSIS >

[BOSE AUDIO WITH NAVIGATION]

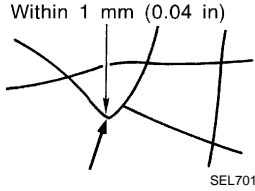
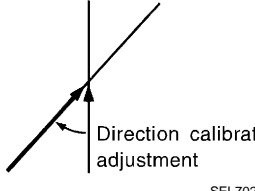
Cause (condition)	-: While driving    ooo: Display	Driving condition	Remarks (correction, etc.)
Precautions for driving	Just after the engine is started	If the vehicle is driven just after the engine is started when the gyroscope (angular speed sensor) correction is not completed, the vehicle can lose its direction and may have deviated from the correct location.	Wait for a short while before driving after starting the engine.
	Continuous driving without stopping	When driving long distances without stopping, direction errors may accumulate, and the current-location mark may deviate from the correct road.	Stop and adjust the orientation.
	Abusive driving	Spinning the wheels or engaging in other kinds of abusive driving may result in the system being unable to perform correct detection, and may cause the vehicle mark to deviate from the correct road.	If after travelling about 10 km (6 miles) the correct location has not been restored, perform location correction and, if necessary, direction correction.
How to correct location	Position correction accuracy 	If the accuracy of location settings is poor, accuracy may be reduced when the correct road cannot be found, particularly in places where there are many roads.	Enter in the road displayed on the screen with an accuracy of approx. 1mm. Caution: Whenever possible, use detailed map for the correction.
	Direction when location is corrected 	If the accuracy of location settings during correction is poor, accuracy may be reduced afterwards.	Perform direction correction.

### Location Correction by Map-Matching is Slow

- The map-matching function needs to refer to the data of the surrounding area. It is necessary to drive some distance for the function to work.
- Because map-matching operates on this principle, when there are many roads running in similar directions in the surrounding area, no matching determination may be made. The location may not be corrected until some special feature is found.

### Name of Road is Not Displayed

The current road name may not be displayed if there are no road names displayed on the map screen.

### Contents of Display Differ for Birdview™ and the (Flat) Map Screen

Difference of the BIRDVUE™ screen from the flat map screen are as follows.

- The current place name displays names which are primarily in the direction of vehicle travel.
- The amount of time before the vehicle travel or turn angle is updated on the screen is longer than for the (flat) map display.
- The conditions for display of place names, roads, and other data are different for nearby areas and for more distant areas.
- Some thinning of the character data is done to prevent the display becoming too complex. In some cases and in some locations, the display contents may differ.
- The same place name, street name, etc. may be displayed multiple times.

### Vehicle Mark Shows a Position Which is Completely Wrong

In the following cases, the vehicle mark may appear on completely different position in the map depending on the GPS satellite signal receiving conditions. In this case, perform location correction and direction correction.

- When location correction has not been done
- If the receiving conditions of the GPS satellite signal is poor, if the vehicle mark becomes out of place, it may move to a completely different location and not come back if location correction is not done. The position will be corrected if the GPS signal can be received.
- When the vehicle has traveled by ferry, or when the vehicle has been being towed

## NORMAL OPERATING CONDITION

< SYMPTOM DIAGNOSIS >

[BOSE AUDIO WITH NAVIGATION]

- Because calculation of the current location cannot be done when traveling with the ignition off, for example when traveling by ferry or when being towed, the location before travel is displayed. If the precise location can be detected with GPS, the location will be corrected.

A

### Vehicle Mark Jumps

In the following cases, the vehicle mark may appear to jump as a result of automatic correction of the current location.

B

- When map matching has been done
  - If the current location and the vehicle mark are different when map matching is done, the vehicle mark may seem to jump. At this time, the location may be “corrected” to the wrong road or to a location which is not on a road.
- When GPS location correction has been done
  - If the current location and the vehicle mark are different when the location is corrected using GPS measurements, the vehicle mark may seem to jump. At this time, the location may be “corrected” to a location which is not on a road.

C

D

### Vehicle Mark is in a River or Sea

The navigation system moves the vehicle mark with no distinction between land and rivers or sea. If the vehicle mark is somehow out of place, it may appear that the vehicle is driving in a river or the sea.

E

### Vehicle Mark Automatically Rotates

The system wrongly memorizes the rotating status as stopping when the ignition switch is turned ON with the turntable rotating. That causes the vehicle mark to rotate when the vehicle is stopped.

F

### When Driving on Same Road, Sometimes Vehicle Mark is in Right Place and Sometimes it is in Wrong Place

The conditions of the GPS antenna (GPS data) and gyroscope (angular speed sensor) change gradually. Depending on the road traveled and the operation of the steering wheel, the location detection results will be different. Therefore, even on a road on which the location has never been wrong, conditions may cause the vehicle mark to deviate.

G

H

I

J

K

L

M

AV

O

P

# PRECAUTION

## PRECAUTIONS

### Supplemental Restraint System (SRS) "AIR BAG" and "SEAT BELT PRE-TENSIONER"

INFOID:000000001346152

The Supplemental Restraint System such as "AIR BAG" and "SEAT BELT PRE-TENSIONER", used along with a front seat belt, helps to reduce the risk or severity of injury to the driver and front passenger for certain types of collision. This system includes seat belt switch inputs and dual stage front air bag modules. The SRS system uses the seat belt switches to determine the front air bag deployment, and may only deploy one front air bag, depending on the severity of a collision and whether the front occupants are belted or unbelted. Information necessary to service the system safely is included in the SR and SB section of this Service Manual.

**WARNING:**

- To avoid rendering the SRS inoperative, which could increase the risk of personal injury or death in the event of a collision which would result in air bag inflation, all maintenance must be performed by an authorized NISSAN/INFINITI dealer.
- Improper maintenance, including incorrect removal and installation of the SRS, can lead to personal injury caused by unintentional activation of the system. For removal of Spiral Cable and Air Bag Module, see the SR section.
- Do not use electrical test equipment on any circuit related to the SRS unless instructed to in this Service Manual. SRS wiring harnesses can be identified by yellow and/or orange harnesses or harness connectors.

### Precaution for Trouble Diagnosis

INFOID:000000001346153

#### AV COMMUNICATION SYSTEM

- Do not apply voltage of 7.0 V or higher to the measurement terminals.
- Use the tester with its open terminal voltage being 7.0 V or less.
- Be sure to turn ignition switch OFF and disconnect the battery cable from the negative terminal before checking the circuit.

### Precaution for Harness Repair

INFOID:000000001346154

#### AV COMMUNICATION SYSTEM

- Solder the repaired parts, and wrap with tape. [Frays of twisted line must be within 110 mm (4.33 in).]

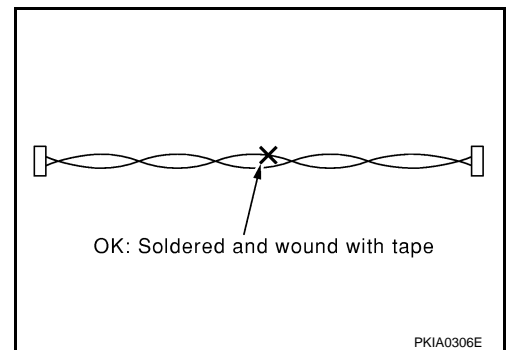

- Do not perform bypass wire connections for the repair parts. (The spliced wire will become separated and the characteristics of twisted line will be lost.)

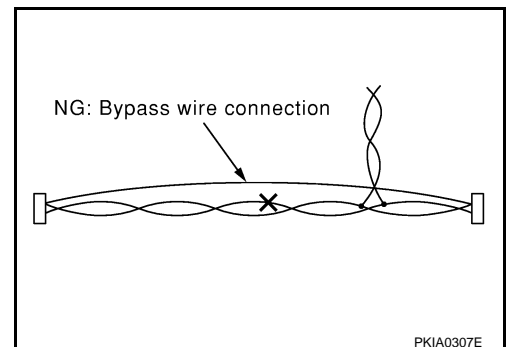



# PREPARATION

## PREPARATION

### Commercial Service Tools

INFOID:000000001346155

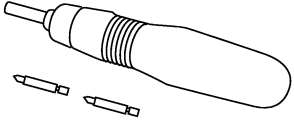
Tool name	Description
<p>Power tool</p>  <p>PBIC0191E</p>	<p>Loosening bolts and nuts</p>

A  
B  
C  
D  
E  
F  
G  
H  
I  
J  
K  
L  
M  
AV  
O  
P

AV

**ON-VEHICLE REPAIR****AUDIO UNIT****Removal and Installation**

INFOID:000000001346156

**REMOVAL**

1. Remove cluster lid C. Refer to [JP-11, "Removal and Installation"](#).
2. Remove cluster lid D lower finisher. Refer to [JP-11, "Removal and Installation"](#).
3. Remove navigation audio unit upper and lower screws (A).

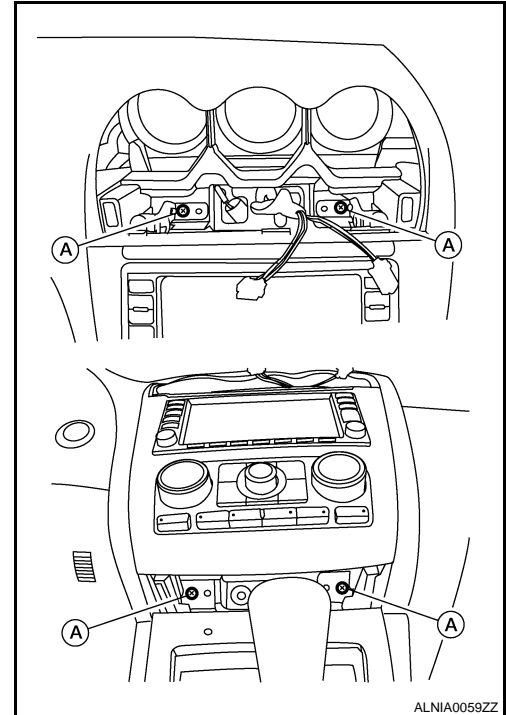

4. Remove the navigation audio unit bracket screws (A) and remove the navigation audio unit bracket (1).

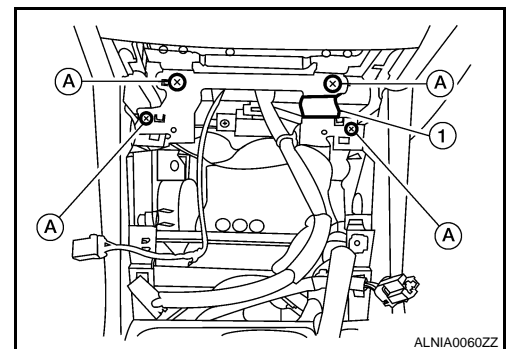

5. Pull out the navigation audio unit assembly, disconnect the navigation audio unit assembly connectors.

**INSTALLATION**

Installation is in the reverse order of removal.

## BOSE SPEAKER AMP

### Removal and Installation - Coupe

INFOID:000000003185339

#### REMOVAL

1. Disconnect the battery negative terminal.
2. Remove the trunk floor carpet and spare tire cover. Refer to [INT-22, "Removal and Installation"](#).
3. Remove the RH trunk floor spacer.
4. Remove the Bose speaker amp. screws (A), then disconnect the Bose speaker amp. connectors (B) and remove the Bose speaker amp. (1).

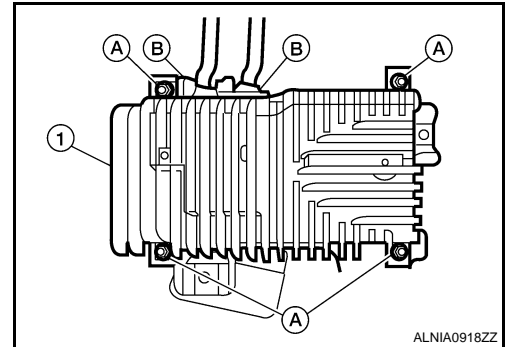

#### INSTALLATION

Installation is in the reverse order of removal.

### Removal and Installation - Sedan

INFOID:000000003185340

#### REMOVAL

1. Disconnect the battery negative terminal.
2. Remove the rear parcel shelf. Refer to [INT-36, "Removal and Installation"](#).
3. Remove the Bose speaker amp. screws (a), then disconnect the Bose speaker amp. connectors and remove the speaker amplifier (1).

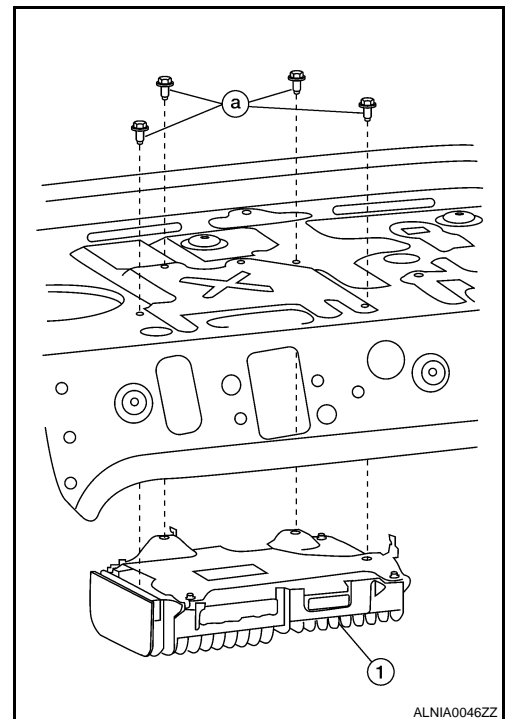

#### INSTALLATION

Installation is in the reverse order of removal.

A  
B  
C  
D  
E  
F  
G  
H  
I  
J  
K  
L  
M  
AV  
O  
P

# CD CHANGER

< ON-VEHICLE REPAIR >

[BOSE AUDIO WITH NAVIGATION]

## CD CHANGER

### Removal and Installation

INFOID:000000003185341

#### REMOVAL

1. Remove the Cluster D lower finisher. Refer to [JP-11, "Removal and Installation"](#).
2. Put selector lever in the drive "D" position (CVT models only).
3. Put shift lever in neutral (M/T models only).
4. Using a suitable tool remove the CD changer finisher (1), then disconnect the power socket, AUX jack connectors and remove the CD changer finisher (1).

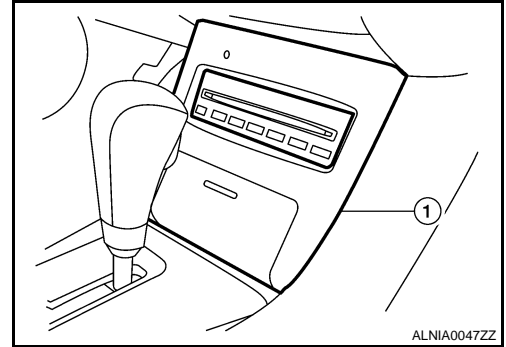

5. Remove the CD changer screws (A), pull out the unit, then disconnect the CD changer connector and remove the CD changer (1).

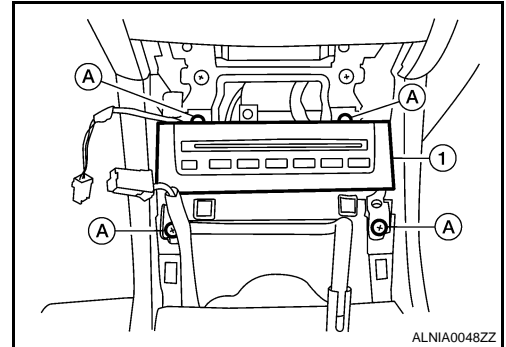

6. Remove the CD changer bracket screws (A).
  - CD changer brackets (1)
  - CD changer (2)

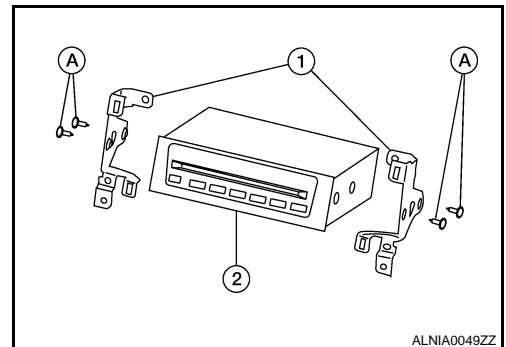

#### INSTALLATION

Installation is in the reverse order of removal.

## FRONT TWEETER

### Removal and Installation

INFOID:000000003185348

#### REMOVAL

1. Remove the front pillar finisher. Refer to [INT-19, "Removal and Installation"](#).
2. Remove tweeter speaker grille. Refer to [IP-11, "Removal and Installation"](#).
3. Remove the tweeter speaker screws (A), disconnect the tweeter speaker connector and remove the tweeter speaker (1).

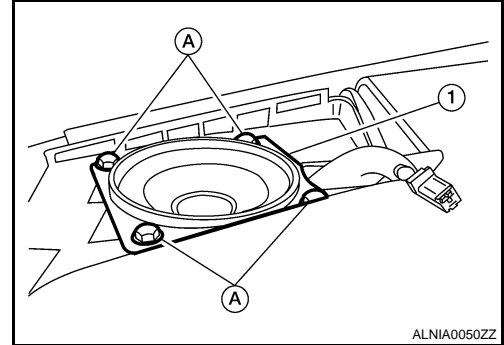

#### INSTALLATION

Installation is in the reverse order of removal.

A  
B  
C  
D  
E  
F  
G  
H  
I  
J  
K  
L  
M  
O  
P

AV

# CENTER SPEAKER

< ON-VEHICLE REPAIR >

[BOSE AUDIO WITH NAVIGATION]

## CENTER SPEAKER

### Removal and Installation

INFOID:000000003185349

#### REMOVAL

1. Remove the center speaker grille. Refer to [IP-11, "Removal and Installation"](#).
2. Remove the center speaker screws (A), then pull out the center speaker (1), then disconnect the center speaker connector and remove the center speaker (1).

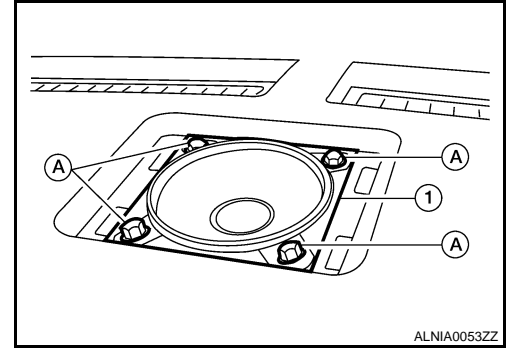

#### INSTALLATION

Installation is in the reverse order of removal.

# FRONT DOOR SPEAKER

< ON-VEHICLE REPAIR >

[BOSE AUDIO WITH NAVIGATION]

## FRONT DOOR SPEAKER

### Removal and Installation

INFOID:000000003185350

#### REMOVAL

1. Remove the front door finisher. Refer to [INT-11, "Removal and Installation"](#).
2. Remove the front door speaker screws (A), then disconnect the front door speaker connector and remove the front door speaker (1).

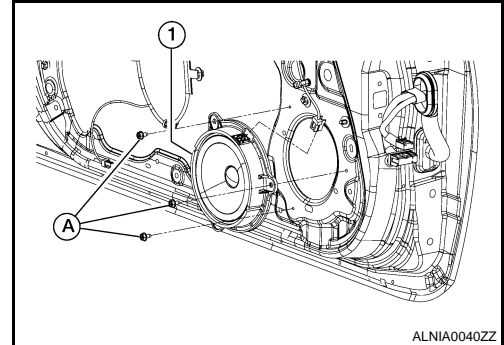

#### INSTALLATION

Installation is in the reverse order of removal.

A  
B  
C  
D  
E  
F  
G  
H  
I  
J  
K  
L  
M  
O  
P

AV

## REAR DOOR SPEAKER

< ON-VEHICLE REPAIR >

[BOSE AUDIO WITH NAVIGATION]

### REAR DOOR SPEAKER

#### Removal and Installation - Sedan

INFOID:000000003185351

#### REMOVAL

1. Remove the rear door finisher. Refer to [INT-32. "Removal and Installation"](#).
2. Remove the rear door speaker screws (A), then disconnect the rear door speaker connector and remove the rear door speaker (1).

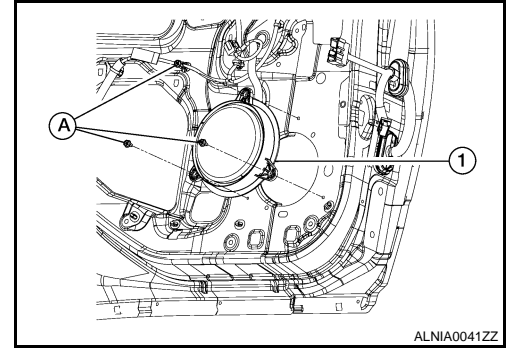

#### INSTALLATION

Installation is in the reverse order of removal.



## REAR TWEETER

### Removal and Installation - Coupe

INFOID:000000003185352

#### REMOVAL

1. Remove the rear parcel shelf finisher. Refer to [INT-16. "Removal and Installation"](#).
2. Remove the rear tweeter speaker screws (A) and remove the rear tweeter speaker (1).

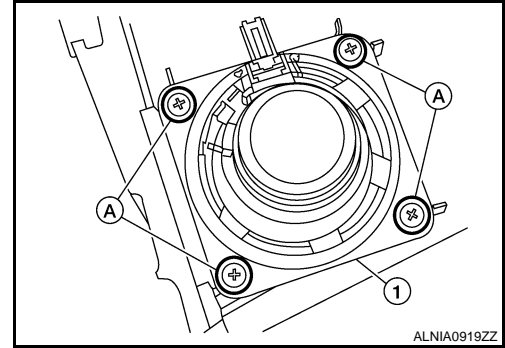

#### INSTALLATION

Installation is in the reverse order of removal.

A  
B  
C  
D  
E  
F  
G  
H  
I  
J  
K  
L  
M  
O  
P

AV

# REAR SPEAKER

< ON-VEHICLE REPAIR >

[BOSE AUDIO WITH NAVIGATION]

## REAR SPEAKER

### Removal and Installation - Coupe

INFOID:000000003185353

#### REMOVAL

1. Remove the trunk front finisher. Refer to [INT-22, "Removal and Installation"](#).
2. Remove the rear speaker screws (A), then disconnect the rear speaker connector (B) and remove the rear speaker (1).

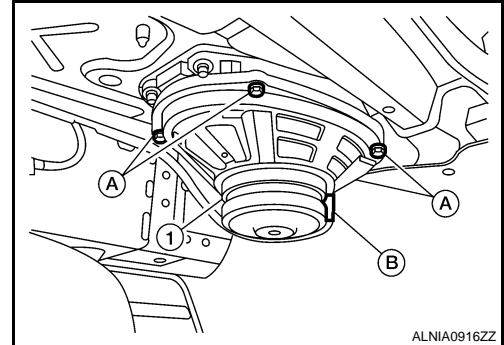

#### INSTALLATION

Installation is in the reverse order of removal.

### Removal and Installation - Sedan

INFOID:000000003185354

#### REMOVAL

1. Remove the rear parcel shelf finisher. Refer to [INT-44, "Removal and Installation"](#).
2. Remove the rear speaker screws (A), then disconnect the rear speaker and remove the rear speaker (1).

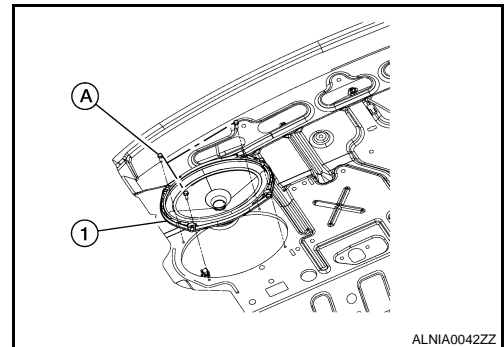

#### INSTALLATION

Installation is in the reverse order of removal.

# SATELLITE RADIO TUNER

< ON-VEHICLE REPAIR >

[BOSE AUDIO WITH NAVIGATION]

## SATELLITE RADIO TUNER

### Removal and Installation - Coupe

INFOID:000000003185355

For removal and installation, refer to [AV-422. "Removal and Installation"](#).

### Removal and Installation - Sedan

INFOID:000000003185356

For removal and installation, refer to [AV-422. "Removal and Installation"](#).

A

B

C

D

E

F

G

H

I

J

K

L

M

AV

O

P

# SATELLITE RADIO ANTENNA

< ON-VEHICLE REPAIR >

[BOSE AUDIO WITH NAVIGATION]

## SATELLITE RADIO ANTENNA

### Removal and Installation

INFOID:000000003185357

#### REMOVAL

1. Lower the headliner at the rear. Refer to [INT-19, "Removal and Installation"](#).
2. Remove the satellite radio antenna nut (A), then disconnect the satellite radio antenna connector (B) and remove the satellite radio antenna (1).

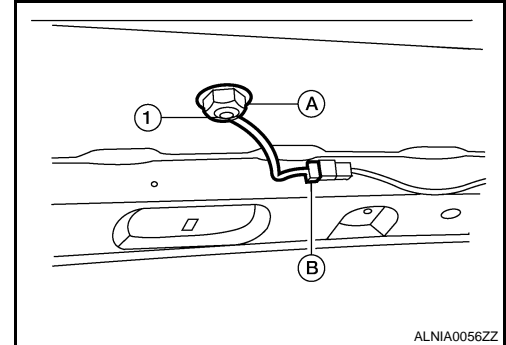

#### INSTALLATION

Installation is in the reverse order of removal.

## GPS ANTENNA

### Removal and Installation

INFOID:000000001346167

#### REMOVAL

1. Remove the combination meter. Refer to [MWI-172, "Removal and Installation"](#).
2. Remove the navigation audio unit. Refer to [AV-422, "Removal and Installation"](#).
3. Remove the GPS navigation antenna screw (A), then fish the GPS navigation antenna connector and harness (1), through the combination meter instrument panel opening and remove the GPS antenna.

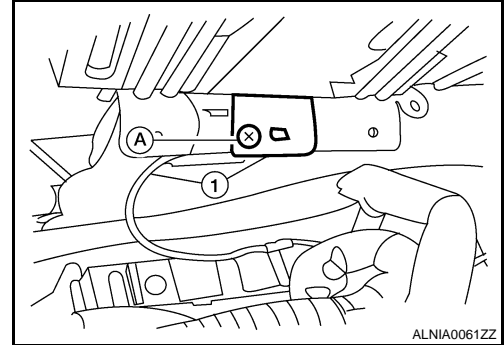

#### INSTALLATION

Installation is in the reverse order of removal.

A  
B  
C  
D  
E  
F  
G  
H  
I  
J  
K  
L  
M  
O  
P

AV

# STEERING SWITCH

< ON-VEHICLE REPAIR >

[BOSE AUDIO WITH NAVIGATION]

## STEERING SWITCH

### Removal and Installation

INFOID:000000003185358

#### REMOVAL

1. Remove the driver airbag module. Refer to [SR-4, "Removal and Installation"](#).
2. Remove the steering wheel switch assembly screws (A), then remove the steering wheel switches (1).

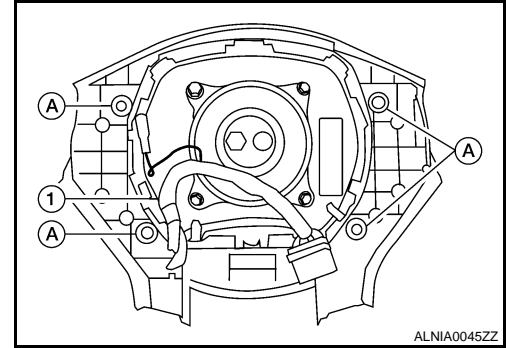

#### INSTALLATION

Installation is in the reverse order of removal.

# AUDIO ANTENNA (COUPE)

< ON-VEHICLE REPAIR >

[BOSE AUDIO WITH NAVIGATION]

## AUDIO ANTENNA (COUPE)

### Location of Antenna

INFOID:000000003214638

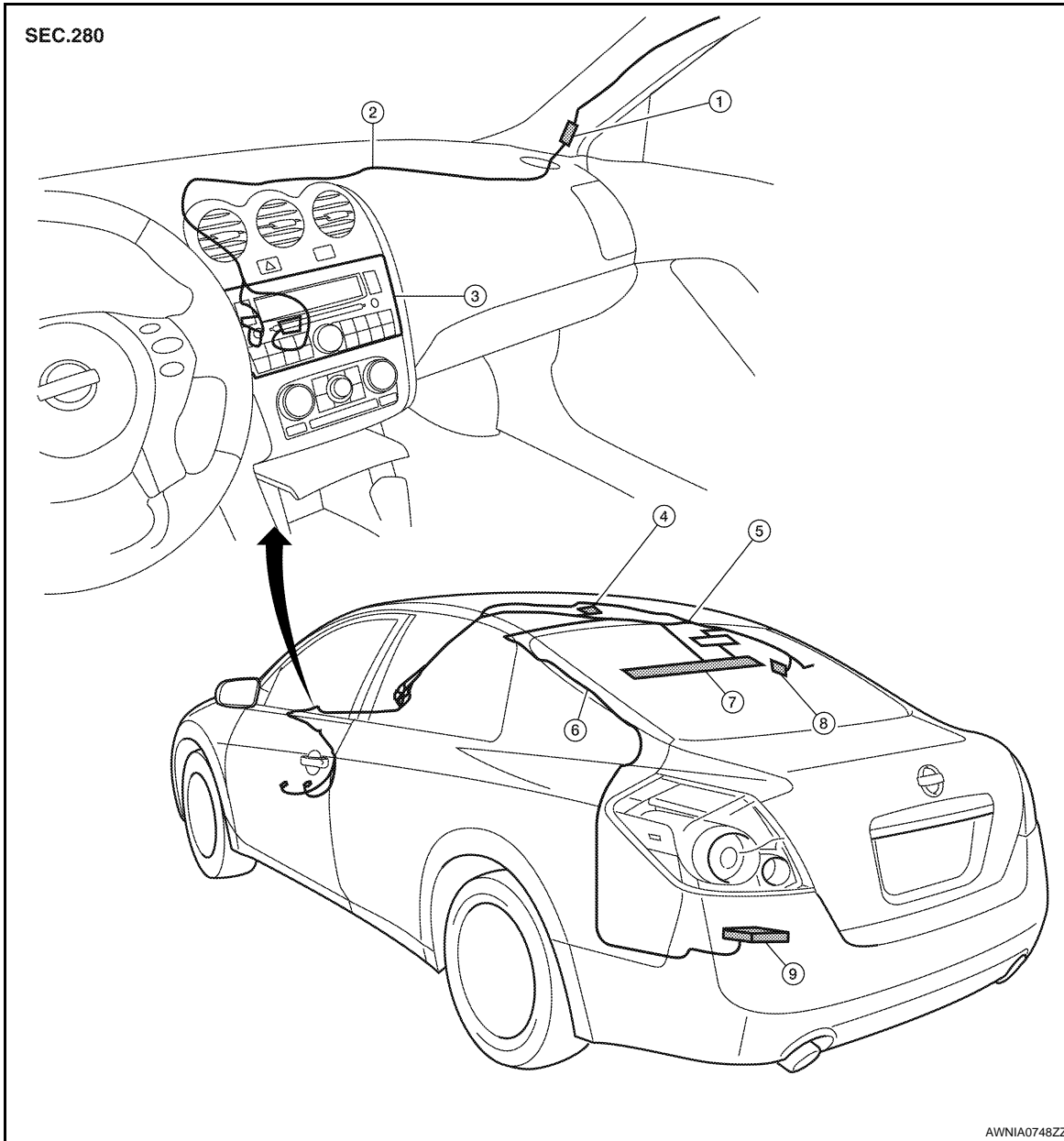

1. In-line connectors M87, M501

2. Audio unit harness

3. Audio unit

4. Satellite antenna

5. Audio antenna feeder

6. Satellite radio antenna feeder

7. Window Antenna

8. Antenna amp.

9. Satellite radio tuner

### Window Antenna Repair

INFOID:000000003214640

### ELEMENT CHECK

A  
B  
C  
D  
E  
F  
G  
H  
I  
J  
K  
L  
M  
N  
O  
P

# AUDIO ANTENNA (COUPE)

[BOSE AUDIO WITH NAVIGATION]

< ON-VEHICLE REPAIR >

1. Attach probe circuit tester (ohm setting) to antenna terminal on each side.

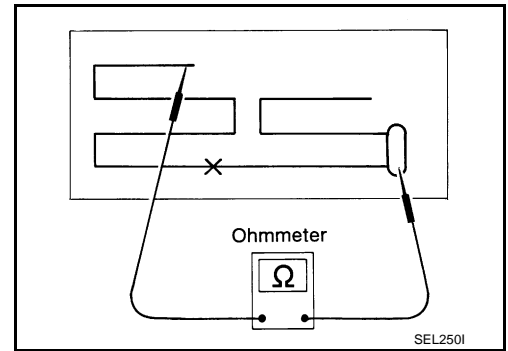

- When measuring continuity, wrap tin foil around the top of probe. Then, press the foil against the wire with your finger.

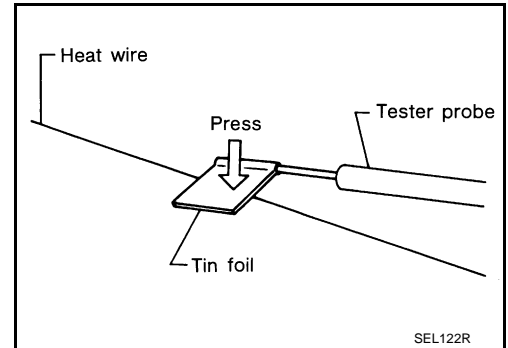

2. If an element is broken, no continuity will exist.

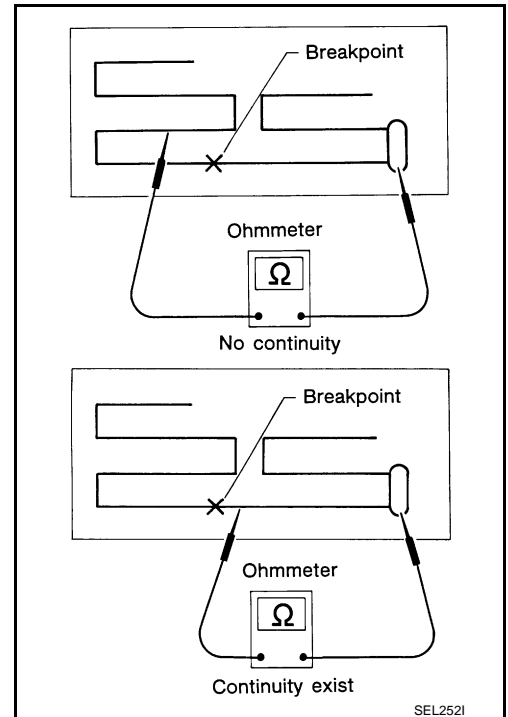

3. To locate a break, move probe along element. Tester indication will change abruptly when probe passes the broken point.

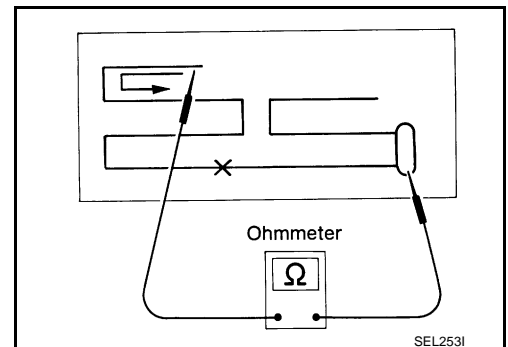



# AUDIO ANTENNA (COUPE)

[BOSE AUDIO WITH NAVIGATION]

< ON-VEHICLE REPAIR >

## REPAIR EQUIPMENT

- Conductive silver composition (DuPont No. 4817 or equivalent)
- Ruler 30 cm (11.8 in) long
- Drawing pen
- Heat gun
- Alcohol
- Cloth

## REPAIRING PROCEDURE

1. Wipe broken heat wire and its surrounding area clean with a cloth dampened in alcohol.
2. Apply a small amount of conductive silver composition to tip of drawing pen. Shake silver composition container before use.
3. Place ruler on glass along broken line. Deposit conductive silver composition on break with drawing pen. Slightly overlap existing heat wire on both sides [preferably 5 mm (0.20 in)] of the break.

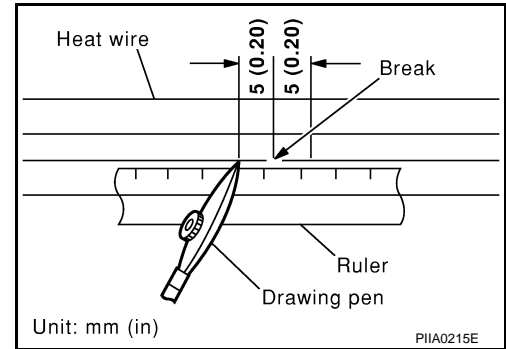

4. After repair has been completed, check repaired wire for continuity. This check should be conducted 10 minutes after silver composition is deposited. Do not touch repaired area while test is being conducted.

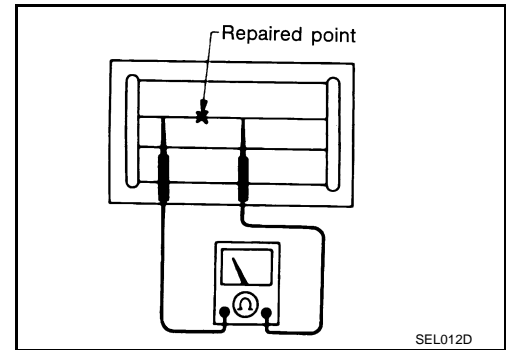

5. Apply a constant stream of hot air directly to the repaired area for approximately 20 minutes with a heat gun. A minimum distance of 3 cm (1.2 in) should be kept between repaired area and hot air outlet. If a heat gun is not available, let the repaired area dry for 24 hours.

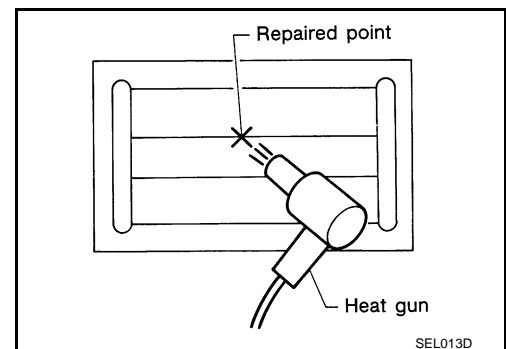

A  
B  
C  
D  
E  
F  
G  
H  
I  
J  
K  
L  
M  
AV  
O  
P

# AUDIO ANTENNA (SEDAN)

< ON-VEHICLE REPAIR >

[BOSE AUDIO WITH NAVIGATION]

## AUDIO ANTENNA (SEDAN)

### Location of Antenna

INFOID:00000000322317

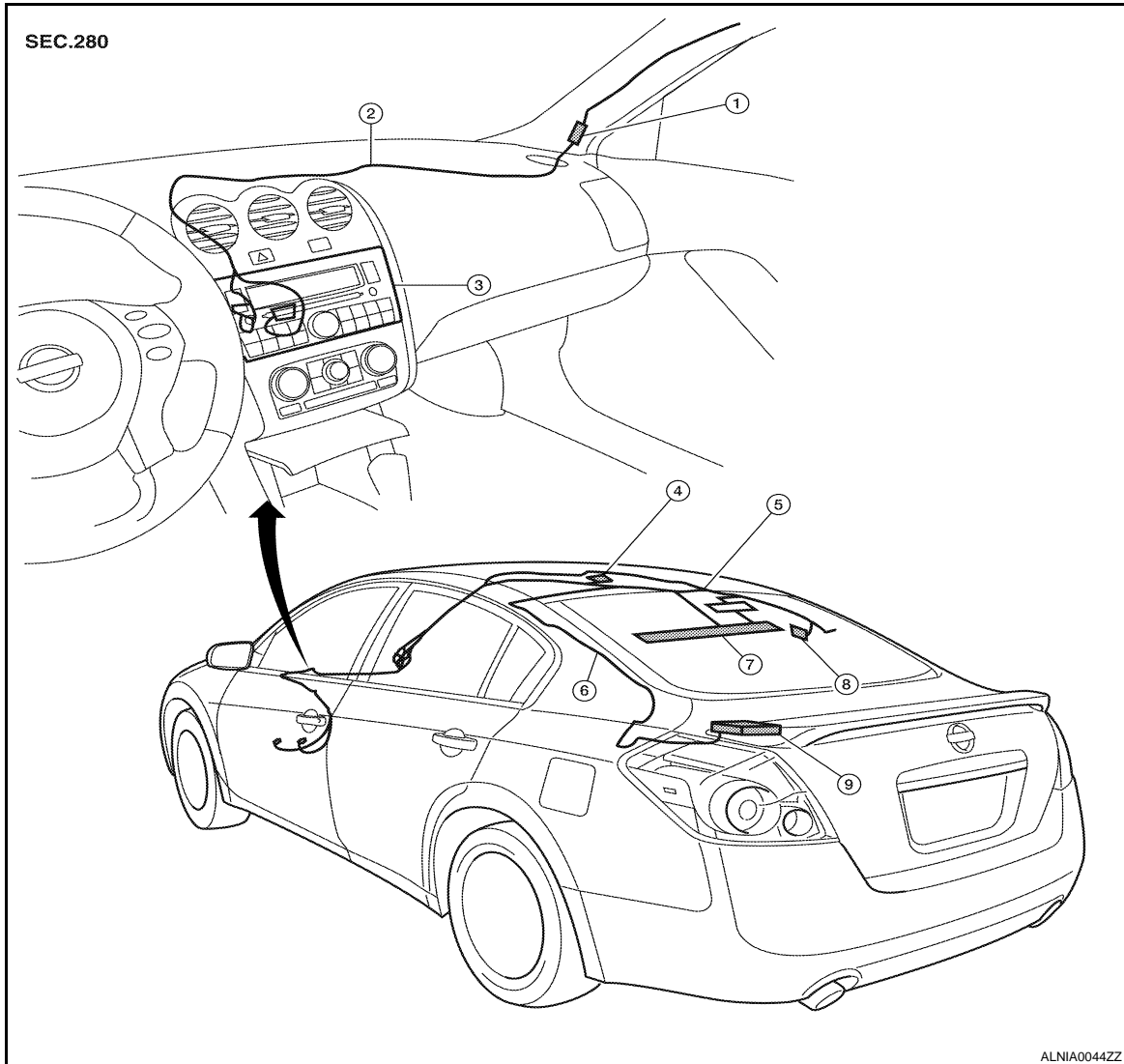

- |                                 |                         |                                   |
|---------------------------------|-------------------------|-----------------------------------|
| 1. In-line connectors M87, M501 | 2. Audio unit harness   | 3. Audio unit                     |
| 4. Satellite antenna            | 5. Audio antenna feeder | 6. Satellite radio antenna feeder |
| 7. Window Antenna               | 8. Antenna amp.         | 9. Satellite radio tuner          |

### Window Antenna Repair

INFOID:00000000322318

#### ELEMENT CHECK

1. Attach probe circuit tester (ohm setting) to antenna terminal on each side.

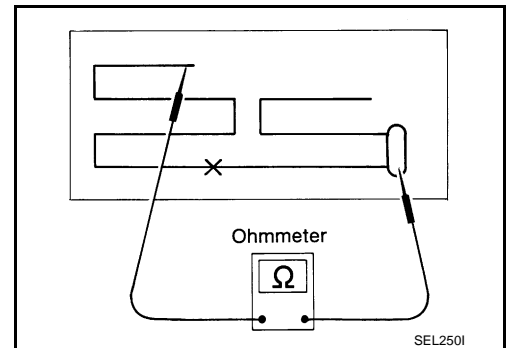

# AUDIO ANTENNA (SEDAN)

< ON-VEHICLE REPAIR >

[BOSE AUDIO WITH NAVIGATION]

- When measuring continuity, wrap tin foil around the top of probe. Then, press the foil against the wire with your finger.

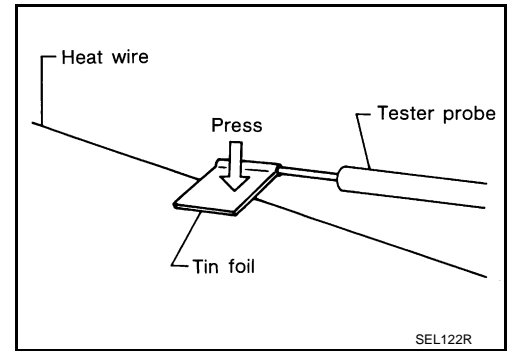

2. If an element is broken, no continuity will exist.

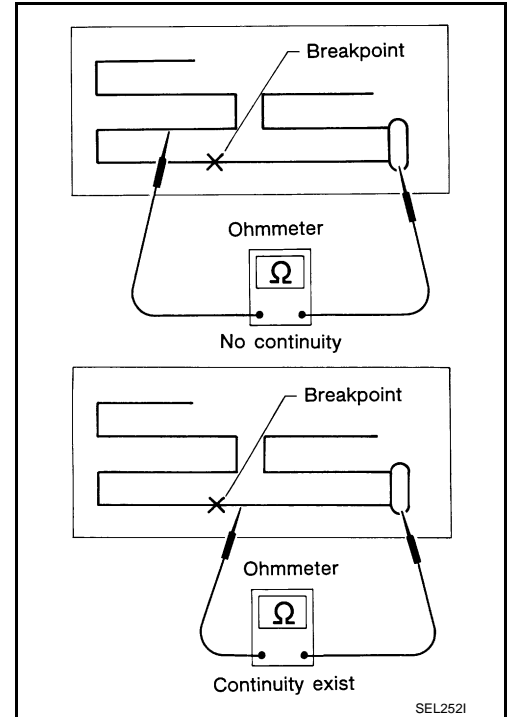

3. To locate a break, move probe along element. Tester indication will change abruptly when probe passes the broken point.

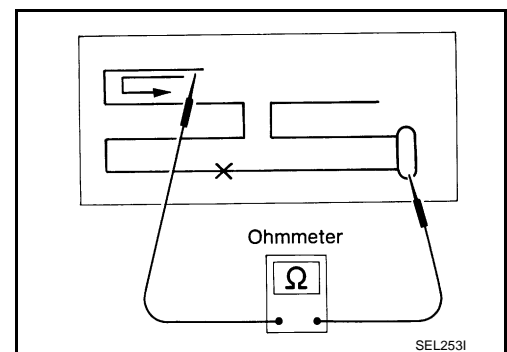

## REPAIR EQUIPMENT

- Conductive silver composition (DuPont No. 4817 or equivalent)
- Ruler 30 cm (11.8 in) long
- Drawing pen
- Heat gun
- Alcohol
- Cloth

## REPAIRING PROCEDURE

A  
B  
C  
D  
E  
F  
G  
H  
I  
J  
K  
L  
M  
AV  
O  
P

## AUDIO ANTENNA (SEDAN)

### < ON-VEHICLE REPAIR >

### [BOSE AUDIO WITH NAVIGATION]

1. Wipe broken heat wire and its surrounding area clean with a cloth dampened in alcohol.
2. Apply a small amount of conductive silver composition to tip of drawing pen. Shake silver composition container before use.
3. Place ruler on glass along broken line. Deposit conductive silver composition on break with drawing pen. Slightly overlap existing heat wire on both sides [preferably 5 mm (0.20 in)] of the break.

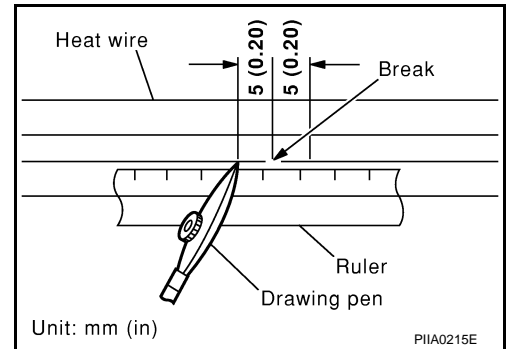

4. After repair has been completed, check repaired wire for continuity. This check should be conducted 10 minutes after silver composition is deposited.  
Do not touch repaired area while test is being conducted.

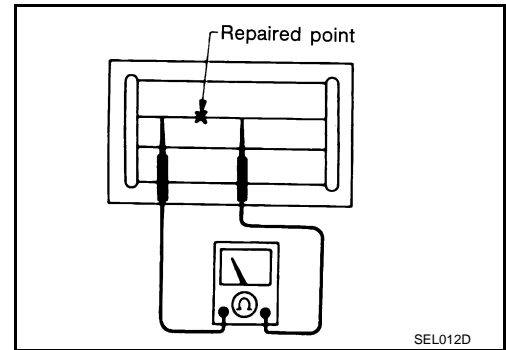

5. Apply a constant stream of hot air directly to the repaired area for approximately 20 minutes with a heat gun. A minimum distance of 3 cm (1.2 in) should be kept between repaired area and hot air outlet.  
If a heat gun is not available, let the repaired area dry for 24 hours.

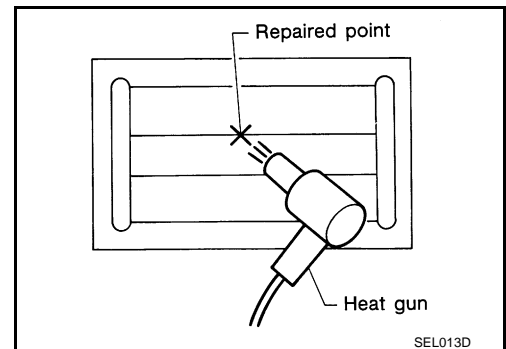

# ANTENNA AMP.

< ON-VEHICLE REPAIR >

[BOSE AUDIO WITH NAVIGATION]

## ANTENNA AMP.

### Removal and Installation - Coupe

INFOID:000000003185544

#### REMOVAL

1. Remove the rear pillar finisher RH. Refer to [INT-19, "Exploded View"](#).
2. Detach the antenna amp harness clip (B), disconnect the antenna amp connectors (A), remove the antenna amp screw (C) and remove the antenna amp (1).

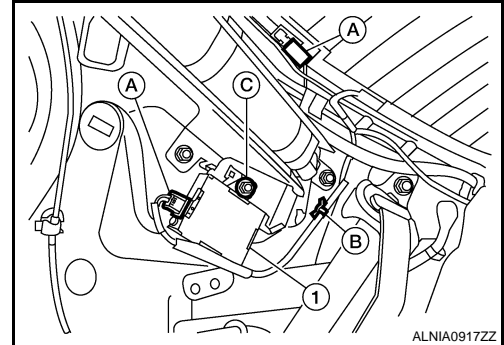

#### INSTALLATION

Installation is in the reverse order of removal.

### Removal and Installation - Sedan

INFOID:000000003185545

#### REMOVAL

1. Remove the rear pillar finisher RH. Refer to [INT-40, "Exploded View"](#).
2. Partially remove the side curtain air bag module RH to gain access to the antenna amp. Refer to [SR-10, "Removal and Installation"](#).
3. Detach the antenna amp harness clip (A), disconnect the antenna amp connectors (B), remove the antenna amp screw (C) and remove the antenna amp (1).

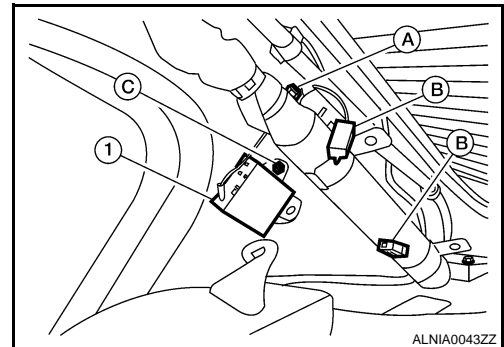

#### INSTALLATION

Installation is in the reverse order of removal.

A  
B  
C  
D  
E  
F  
G  
H  
I  
J  
K  
L  
M  
O  
P

AV

## MICROPHONE

### Removal and Installation - Coupe

INFOID:000000003185546

#### REMOVAL - WITH SUNROOF

1. Remove the map lamp assembly. Refer to [INT-19, "Exploded View"](#).
2. Detach the microphone connector (A).

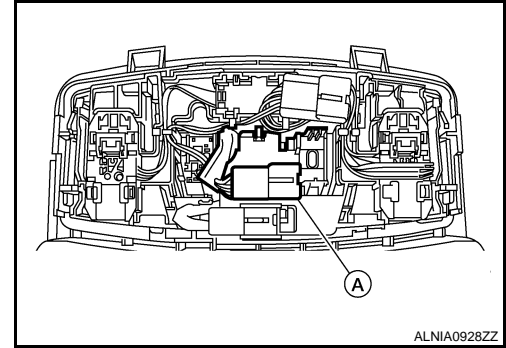

3. Remove the map lamp covers (1), then remove the map lamp assembly cover (2).

**NOTE:**

This step and the following step are (non sunroof only).

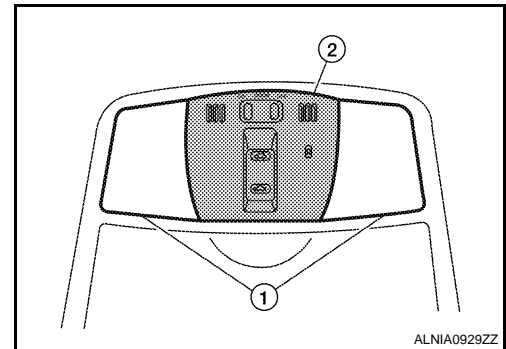

4. Release the microphone tabs (A), then remove the microphone (1).

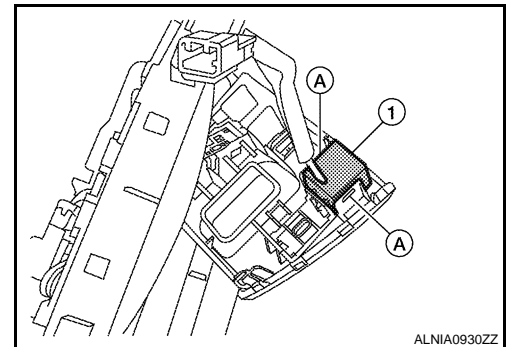

#### INSTALLATION

Installation is in the reverse order of removal.

### Removal and Installation - Sedan

INFOID:000000003185547

#### REMOVAL

1. Remove the map lamp. Refer to [INT-40, "Exploded View"](#).
2. Remove the Bluetooth microphone (2).

# MICROPHONE

< ON-VEHICLE REPAIR >

[BOSE AUDIO WITH NAVIGATION]

- Map lamp (1)

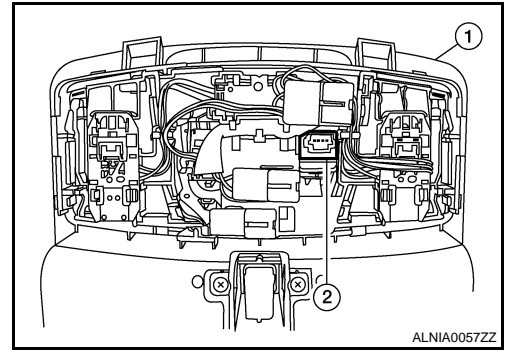

## INSTALLATION

Installation is in the reverse order of removal.

A  
B  
C  
D  
E  
F  
G  
H  
I  
J  
K  
L  
M  
AV  
O  
P

## TEL ANTENNA

## Removal and Installation - Coupe

INFOID:000000003185548

## REMOVAL

1. Remove the trunk front finisher, trunk floor carpet and spare tire cover. Refer to [INT-21, "Exploded View"](#).
2. Remove the LH trunk floor spacer.
3. Remove the rear pillar LH. Refer to [INT-19, "Exploded View"](#).
4. Remove the rear parcel shelf. Refer to [INT-16, "Removal and Installation"](#).
5. Remove the Bluetooth antenna screw (A), then detach the Bluetooth antenna harness clips, disconnect the Bluetooth antenna connector and remove the Bluetooth antenna (1).

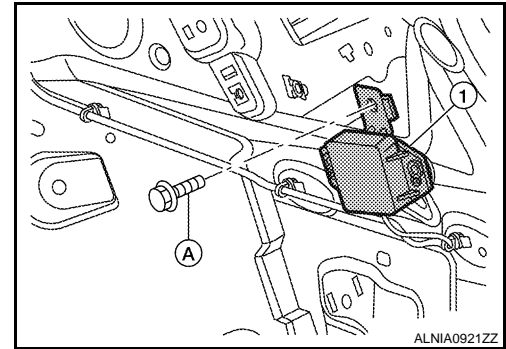

## INSTALLATION

Installation is in the reverse order of removal.

## Removal and Installation - Sedan

INFOID:000000003185549

## REMOVAL

1. Remove the rear parcel shelf. Refer to [INT-36, "Removal and Installation"](#).
2. Remove the Bluetooth antenna screw (A), fold down the rear seat, disconnect the Bluetooth antenna connector and remove the Bluetooth antenna (1).

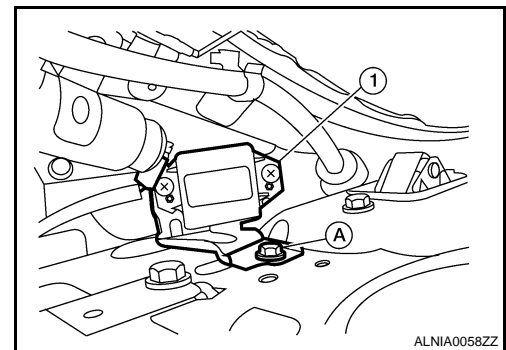

## INSTALLATION

Installation is in the reverse order of removal.



# BLUETOOTH CONTROL UNIT

< ON-VEHICLE REPAIR >

[BOSE AUDIO WITH NAVIGATION]

## BLUETOOTH CONTROL UNIT

### Removal and Installation - Coupe

INFOID:000000003185550

For removal and installation, refer to [AV-422. "Removal and Installation"](#).

### Removal and Installation - Sedan

INFOID:000000003185551

For removal and installation, refer to [AV-422. "Removal and Installation"](#).

A

B

C

D

E

F

G

H

I

J

K

L

M

AV

O

P

## REAR VIEW MONITOR

### Removal and Installation

INFOID:000000003185552

#### REMOVAL

1. Remove the license plate finisher. Refer to [EXT-23, "Removal and Installation"](#).
2. Remove trunk lid finisher. Refer to [INT-21, "Exploded View"](#).
3. Remove the rear view monitor by performing the following:
  - For coupe models, release the clip (A), then pull out the rear view monitor connector, disconnect the rear view monitor connector, press the rear view monitor tab (B) and remove the rear view monitor (1).

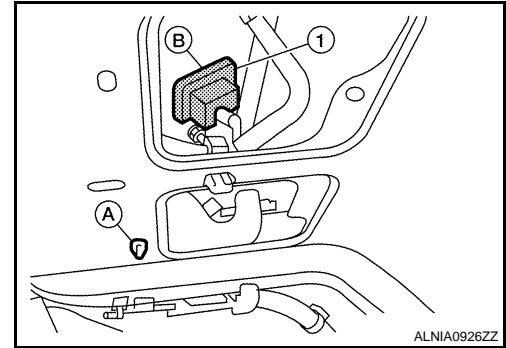

- For sedan models, disconnect the rear view monitor connector (B), press the rear view monitor tab (A) and remove the rear view monitor (1).

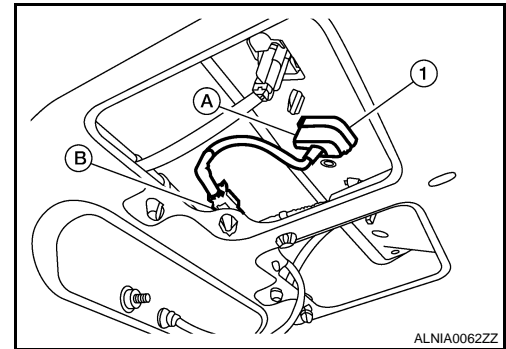

#### INSTALLATION

Installation is in the reverse order of removal.

#### Adjustment

INFOID:000000003185554

#### REAR VIEW MONITOR

For adjustment on the rear view monitor, refer to [DLK-11, "ADDITIONAL SERVICE WHEN REPLACING CONTROL UNIT : Special Repair Requirement"](#).

# CAMERA CONTROL UNIT

< ON-VEHICLE REPAIR >

[BOSE AUDIO WITH NAVIGATION]

## CAMERA CONTROL UNIT

### Removal and Installation - Coupe

INFOID:000000003185555

#### REMOVAL

1. Disconnect the battery negative terminal.
2. Remove the trunk floor carpet and spare tire cover. Refer to [INT-22. "Removal and Installation"](#).
3. Remove the LH trunk side finisher. Refer to [INT-22. "Removal and Installation"](#).
4. Remove the LH trunk floor spacer.
5. Disconnect the rear view monitor control unit connector (A), then remove the rear view monitor screws (B) and remove the rear view monitor control unit (1).

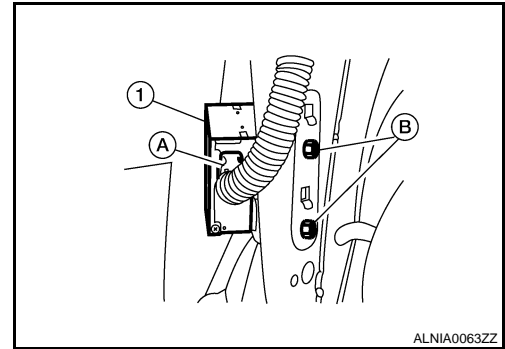

#### INSTALLATION

Installation is in the reverse order of removal.

### Removal and Installation - Sedan

INFOID:000000003185556

#### REMOVAL

1. Remove the trunk side finisher. Refer to [INT-44. "Removal and Installation"](#).
2. Disconnect the rear view monitor control unit connector (A), then remove the rear view monitor screws (B) and remove the rear view monitor control unit (1).

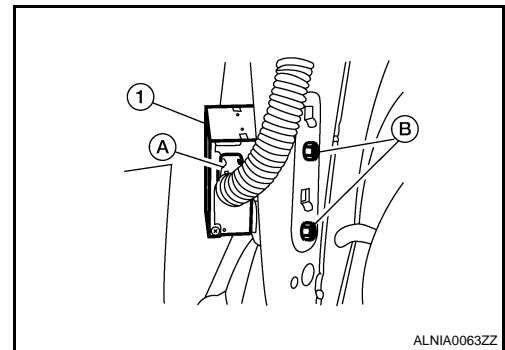

#### INSTALLATION

Installation is in the reverse order of removal.

A  
B  
C  
D  
E  
F  
G  
H  
I  
J  
K  
L  
M  
AV  
O  
P