

A  
B  
C

# SECTION INL

## INTERIOR LIGHTING SYSTEM

### CONTENTS

<p><b>BASIC INSPECTION</b> ..... 3</p> <p><b>DIAGNOSIS AND REPAIR WORKFLOW</b> ..... 3</p> <p style="padding-left: 20px;">Work Flow .....3</p> <p><b>FUNCTION DIAGNOSIS</b> ..... 6</p> <p><b>INTERIOR ROOM LAMP CONTROL SYSTEM</b> ..... 6</p> <p style="padding-left: 20px;">System Diagram .....6</p> <p style="padding-left: 20px;">System Description .....6</p> <p style="padding-left: 20px;">Component Parts Location - Coupe .....7</p> <p style="padding-left: 20px;">Component Parts Location - Sedan .....8</p> <p style="padding-left: 20px;">Component Description .....8</p> <p><b>ILLUMINATION CONTROL SYSTEM</b> .....10</p> <p style="padding-left: 20px;">System Diagram ..... 10</p> <p style="padding-left: 20px;">System Description ..... 10</p> <p style="padding-left: 20px;">Component Parts Location ..... 10</p> <p style="padding-left: 20px;">Component Description ..... 11</p> <p><b>DIAGNOSIS SYSTEM (BCM)</b> .....12</p> <p style="padding-left: 20px;">CONSULT-III Function ..... 12</p> <p><b>COMPONENT DIAGNOSIS</b> .....15</p> <p><b>POWER SUPPLY AND GROUND CIRCUIT</b> .....15</p> <p><b>BCM</b> .....15</p> <p style="padding-left: 20px;">BCM : Inspection Procedure ..... 15</p> <p><b>INTERIOR ROOM LAMP POWER SUPPLY CIRCUIT</b> .....16</p> <p style="padding-left: 20px;">Description ..... 16</p> <p style="padding-left: 20px;">Component Function Check ..... 16</p> <p style="padding-left: 20px;">Diagnosis Procedure ..... 16</p> <p><b>INTERIOR ROOM LAMP CONTROL CIRCUIT</b> .....18</p> <p style="padding-left: 20px;">Description ..... 18</p> <p style="padding-left: 20px;">Component Function Check ..... 18</p> <p style="padding-left: 20px;">Diagnosis Procedure ..... 18</p>	<p style="text-align: right;">D E F G H I J K L M N O P</p> <p><b>STEP LAMP CIRCUIT</b> .....20</p> <p style="padding-left: 20px;">Description .....20</p> <p style="padding-left: 20px;">Component Function Check .....20</p> <p style="padding-left: 20px;">Diagnosis Procedure .....20</p> <p><b>TRUNK ROOM LAMP CIRCUIT</b> .....22</p> <p style="padding-left: 20px;">Description .....22</p> <p style="padding-left: 20px;">Component Function Check .....22</p> <p style="padding-left: 20px;">Diagnosis Procedure .....22</p> <p><b>PUSH-BUTTON IGNITION SWITCH ILLUMINATION CIRCUIT</b> .....24</p> <p style="padding-left: 20px;">Description .....24</p> <p style="padding-left: 20px;">Component Function Check .....24</p> <p style="padding-left: 20px;">Diagnosis Procedure .....24</p> <p><b>INTERIOR ROOM LAMP CONTROL SYSTEM</b> .....26</p> <p style="padding-left: 20px;">Wiring Diagram - Coupe .....26</p> <p style="padding-left: 20px;">Wiring Diagram - Sedan .....37</p> <p><b>ILLUMINATION</b> .....48</p> <p style="padding-left: 20px;">Wiring Diagram - Coupe .....48</p> <p style="padding-left: 20px;">Wiring Diagram - Sedan .....61</p> <p><b>ECU DIAGNOSIS</b> .....74</p> <p><b>BCM (BODY CONTROL MODULE)</b> .....74</p> <p style="padding-left: 20px;">Description .....74</p> <p><b>SYMPTOM DIAGNOSIS</b> .....75</p> <p><b>INTERIOR LIGHTING SYSTEM SYMPTOMS</b> ...75</p> <p style="padding-left: 20px;">Symptom Table .....75</p> <p><b>PRECAUTION</b> .....76</p> <p><b>PRECAUTIONS</b> .....76</p> <p style="padding-left: 20px;">Supplemental Restraint System (SRS) "AIR BAG" and "SEAT BELT PRE-TENSIONER" .....76</p> <p style="padding-left: 20px;">General precautions for service operations .....76</p> <p><b>ON-VEHICLE REPAIR</b> .....77</p>
--	---

---

<b>INTERIOR ROOM LAMP</b> .....	77	<b>SERVICE DATA AND SPECIFICATIONS</b>	
Removal and Installation .....	77	<b>(SDS)</b> .....	82
<b>ILLUMINATION</b> .....	81	<b>SERVICE DATA AND SPECIFICATIONS</b>	
Removal and Installation .....	81	<b>(SDS)</b> .....	82
		Bulb Specifications .....	82

# DIAGNOSIS AND REPAIR WORKFLOW

< BASIC INSPECTION >

## BASIC INSPECTION

### DIAGNOSIS AND REPAIR WORKFLOW

Work Flow

INFOID:000000001830311

#### OVERALL SEQUENCE

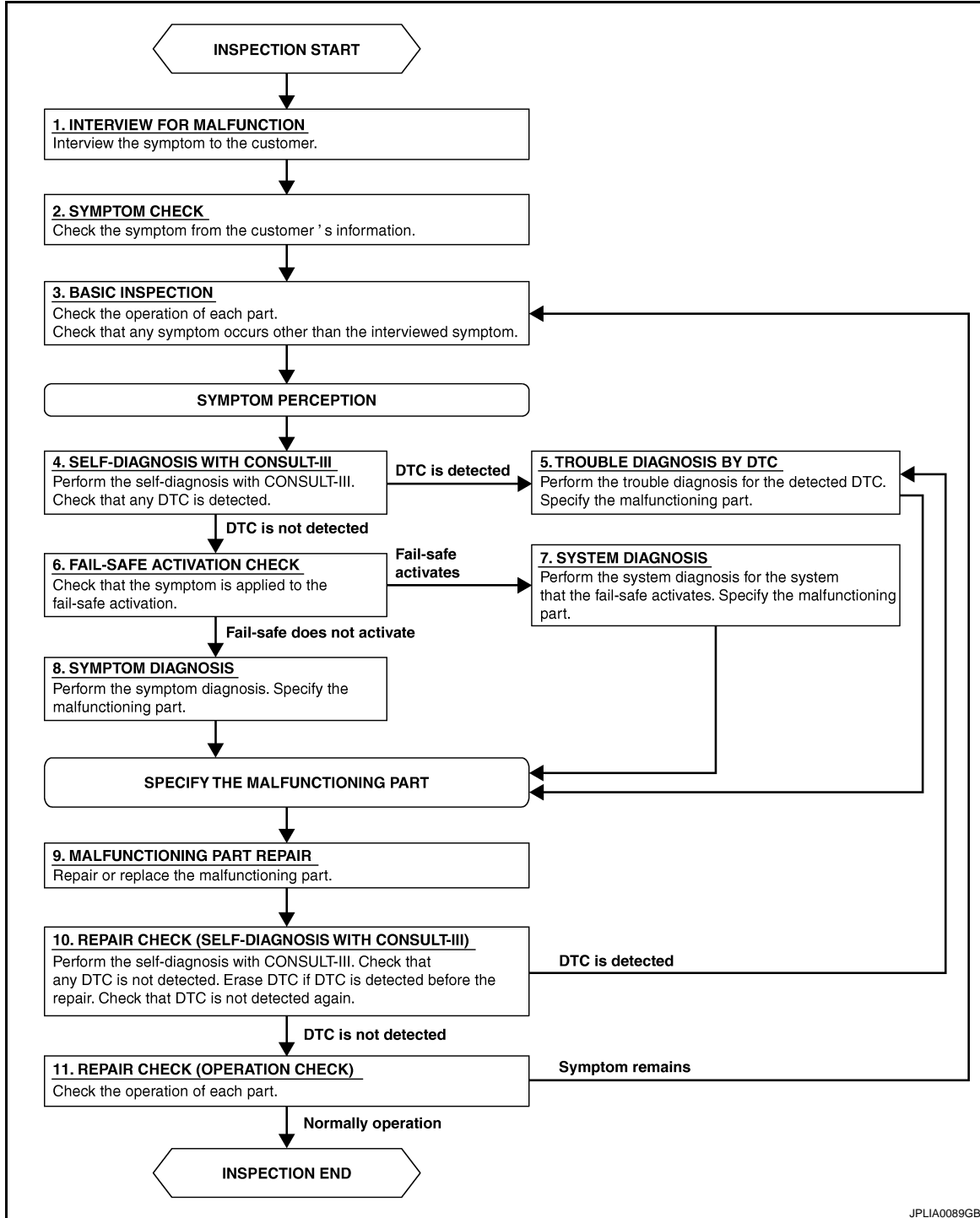

A  
B  
C  
D  
E  
F  
G  
H  
I  
J  
K  
INL  
M  
N  
O  
P

# DIAGNOSIS AND REPAIR WORKFLOW

< BASIC INSPECTION >

---

DETAILED FLOW

## 1. INTERVIEW FOR MALFUNCTION

---

Find out what the customer's concerns are.

>> GO TO 2

## 2. SYMPTOM CHECK

---

Verify the symptom from the customer's information.

>> GO TO 3

## 3. BASIC INSPECTION

---

Check the operation of each part. Check that any concerns occur other than those mentioned in the customer interview.

>> GO TO 4

## 4. SELF-DIAGNOSIS WITH CONSULT-III

---

Perform the self-diagnosis with CONSULT-III. Check that any DTC is detected.

Is any DTC detected?

YES >> GO TO 5

NO >> GO TO 6

## 5. TROUBLE DIAGNOSIS BY DTC

---

Perform the trouble diagnosis for the detected DTC. Specify the malfunctioning part.

>> GO TO 9

## 6. FAIL-SAFE ACTIVATION CHECK

---

Determine if the customer's concern is related to fail-safe activation.

Does the fail-safe activate?

YES >> GO TO 7

NO >> GO TO 8

## 7. SYSTEM DIAGNOSIS

---

Perform the system diagnosis for the system in which the fail-safe activates. Specify the malfunctioning part.

>> GO TO 9

## 8. SYMPTOM DIAGNOSIS

---

Perform the symptom diagnosis. Specify the malfunctioning part.

>> GO TO 9

## 9. MALFUNCTION PART REPAIR

---

Repair or replace the malfunctioning part.

>> GO TO 11

## 10. REPAIR CHECK (SELF-DIAGNOSIS WITH CONSULT-III)

---

Perform the self-diagnosis with CONSULT-III. Verified that no DTCs are detected. Erase all DTCs detected prior to the repair. Verify that DTC is not detected again.

Is any DTC detected?

# DIAGNOSIS AND REPAIR WORKFLOW

< BASIC INSPECTION >

---

YES >> GO TO 5

NO >> GO TO 11

## 11. REPAIR CHECK (OPERATION CHECK)

---

Check the operation of each part.

Does it operate normally?

YES >> INSPECTION END

NO >> GO TO 3

A

B

C

D

E

F

G

H

I

J

K

INL

M

N

O

P

# INTERIOR ROOM LAMP CONTROL SYSTEM

< FUNCTION DIAGNOSIS >

## FUNCTION DIAGNOSIS

### INTERIOR ROOM LAMP CONTROL SYSTEM

#### System Diagram

INFOID:000000001830312

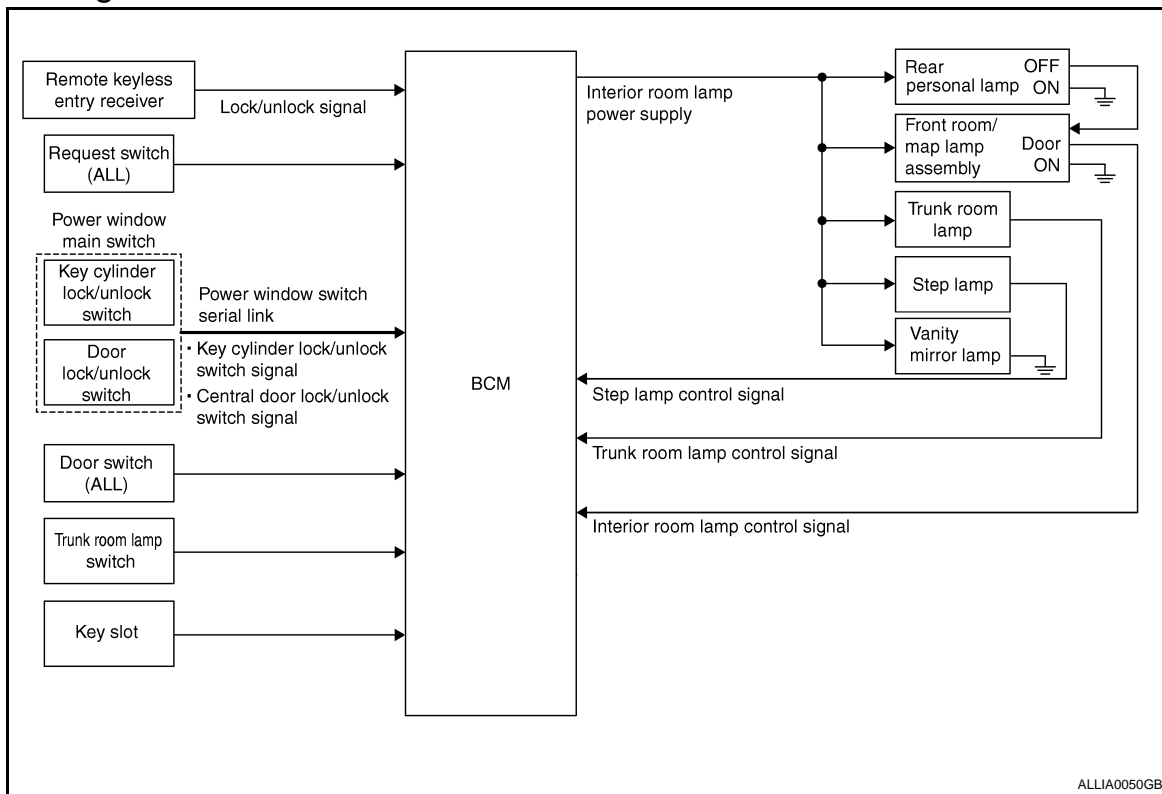

#### System Description

INFOID:000000001830313

#### OUTLINE

- Interior room lamps\* are controlled by interior room lamp timer control function of BCM.  
\*:Front room/map lamps and personal lamps (when lamp switch is in DOOR position).
- Trunk room lamp is controlled by trunk room lamp control function of BCM.
- Step lamps are controlled by step lamp control function of BCM.

# INTERIOR ROOM LAMP CONTROL SYSTEM

< FUNCTION DIAGNOSIS >

## Component Parts Location - Coupe

INFOID:000000003220092

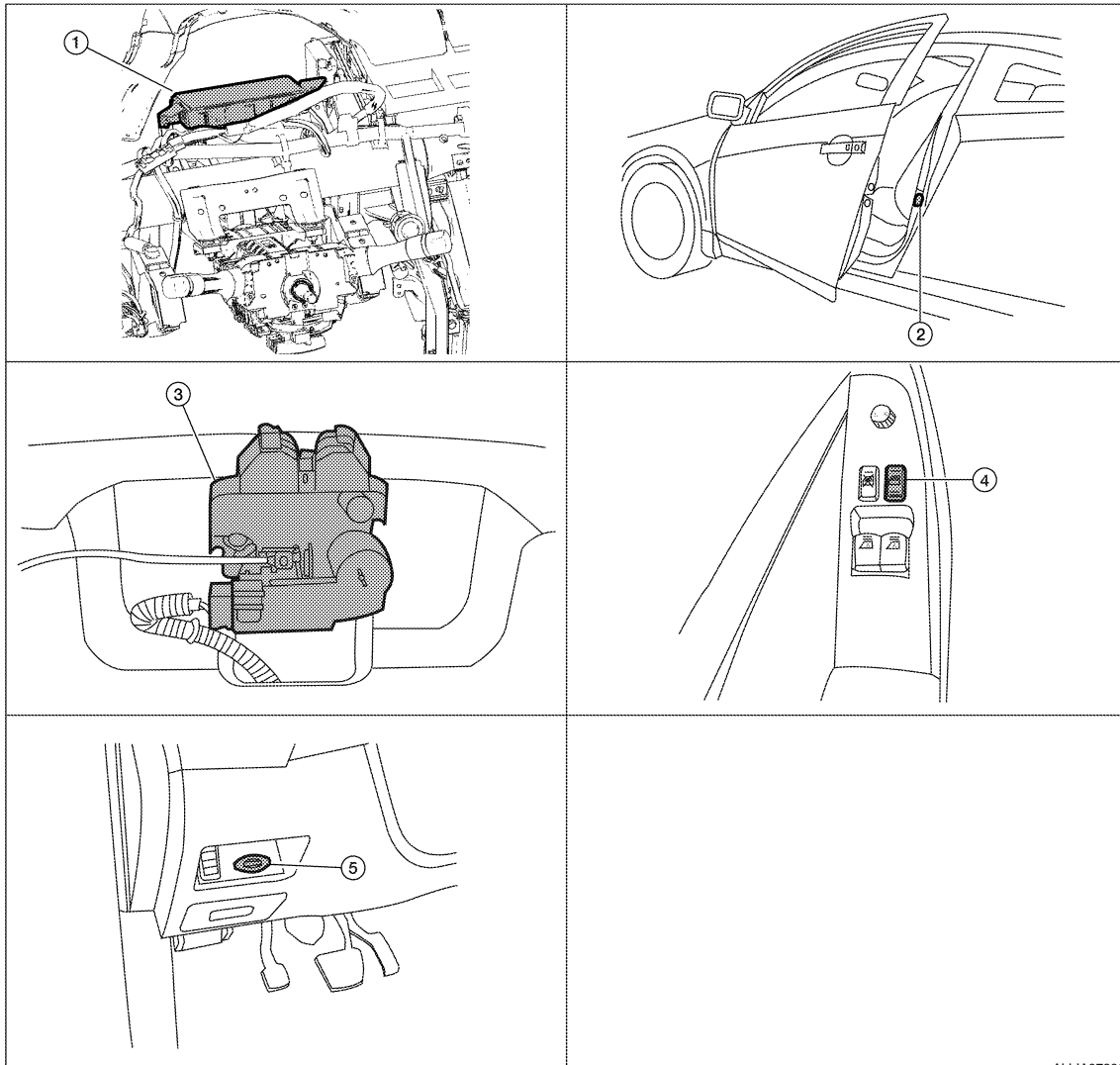

- |   |                               |   |
|---|-------------------------------|---|
| 1. BCM M17, M18, M19, M20, M21 (view with instrument panel removed) | 2. Door switch LH B8, RH B108 | 3. Trunk lamp switch and trunk release solenoid B28 |
| 4. Main power window and door lock/unlock switch D7, D8             | 5. Key slot M40               |   |

ALLIA0780GB

A  
B  
C  
D  
E  
F  
G  
H  
I  
J  
K  
M  
N  
O  
P

INL

# INTERIOR ROOM LAMP CONTROL SYSTEM

< FUNCTION DIAGNOSIS >

## Component Parts Location - Sedan

INFOID:000000001830314

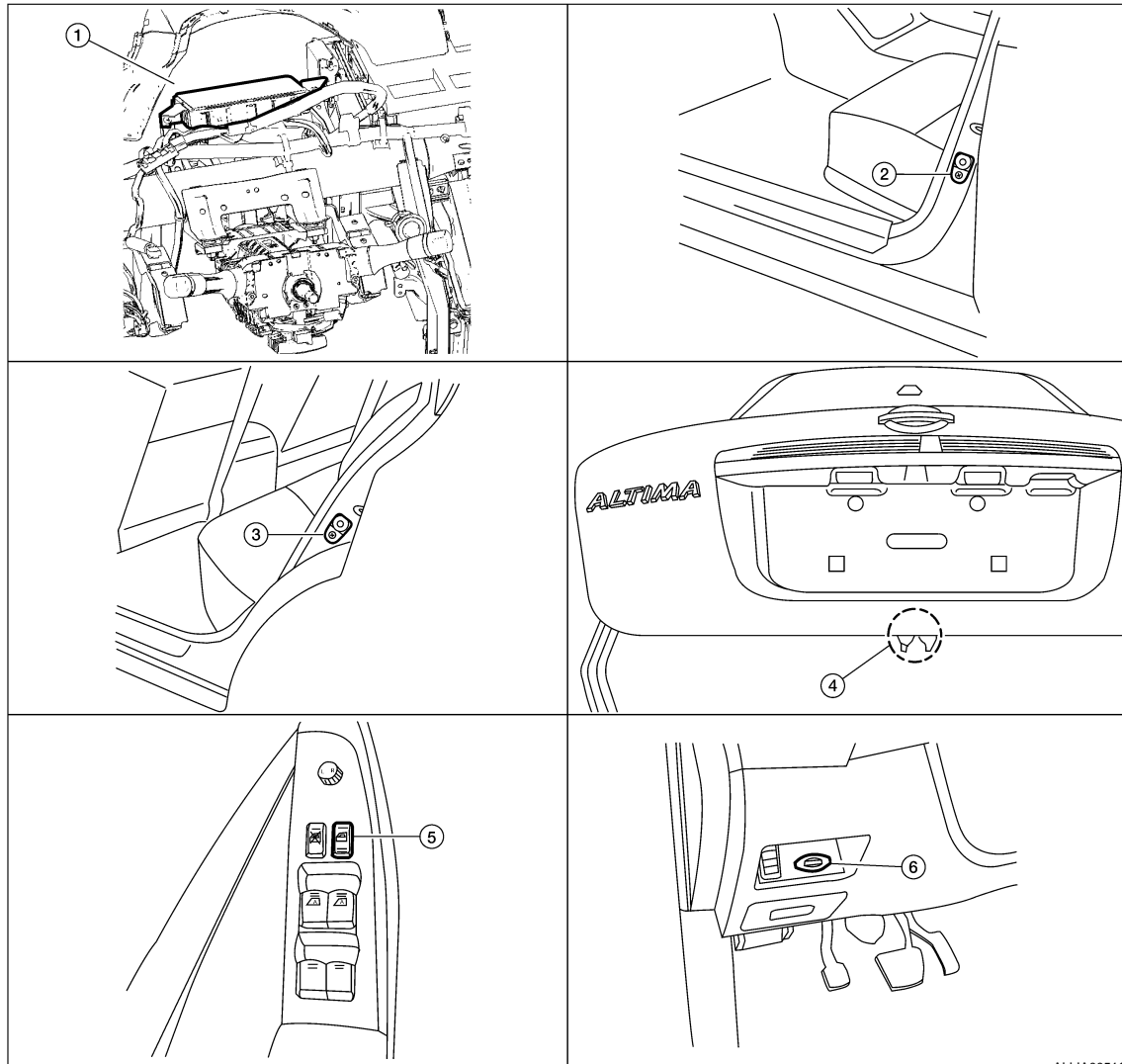

ALLIA0051GB

- |   |   |                                     |
|---|---|-------------------------------------|
| 1. BCM M17, M18, M19, M20, M21 (view with instrument panel removed) | 2. Front door switch LH B8, RH B108                     | 3. Rear door switch LH B18, RH B116 |
| 4. Trunk lamp switch and trunk release solenoid B28                 | 5. Main power window and door lock/unlock switch D7, D8 | 6. Key slot M40                     |

## Component Description

INFOID:000000001830315

### SWITCH OPERATION

When a door is opened, the door switch closes to send a ground signal to the BCM. When the trunk is opened, the trunk lamp switch and trunk release solenoid closes sending a ground signal to the BCM.

### ROOM LAMP TIMER OPERATION

When the interior room lamp switch is in DOOR position and when all conditions below are met, BCM begins timer control (maximum 30 seconds) for interior room lamp ON/OFF.

- When the front door LH is unlocked [with Intelligent Key, main power window and door lock/unlock switch, or front door lock assembly (key cylinder switch)].
- When a door opens → closes and the Intelligent Key is not inserted in the key slot.

Timer control is cancelled under the following conditions.

- When the front door LH is locked [with Intelligent Key, main power window and door lock/unlock switch, or front door lock assembly (key cylinder switch)].



# INTERIOR ROOM LAMP CONTROL SYSTEM

## < FUNCTION DIAGNOSIS >

---

- A door is opened (door switch turns ON).
- Intelligent Key is inserted into the key slot.

Interior lamp operational settings can be changed with the function setting of CONSULT-III.

A

## INTERIOR LAMP BATTERY SAVER CONTROL

If an interior lamp is left ON and does not turn OFF even when the doors are closed, the BCM turns off power to the interior lamps automatically to save the battery 30 minutes after the ignition switch is turned OFF.

The BCM controls the interior lamps listed below

- Step lamp LH and RH
- Front room/map lamp LH and RH
- Room lamp (coupe)
- Personal lamp rear LH and RH (sedan)
- Vanity mirror lamp LH and RH (if equipped)
- Trunk room lamp

After the battery saver system turns the lamps OFF, the lamps will illuminate again when

- a signal is received from an Intelligent Key or main power window and door lock/unlock switch, or when the front door LH lock assembly (key cylinder switch) is locked or unlocked
- a door is opened or closed
- the Intelligent Key is removed from or inserted into the key slot.

The Interior lamp battery saver control time period can be changed with the function setting of CONSULT-III.

B

C

D

E

F

G

H

I

J

K

INL

M

N

O

P

# ILLUMINATION CONTROL SYSTEM

< FUNCTION DIAGNOSIS >

## ILLUMINATION CONTROL SYSTEM

### System Diagram

INFOID:000000001830316

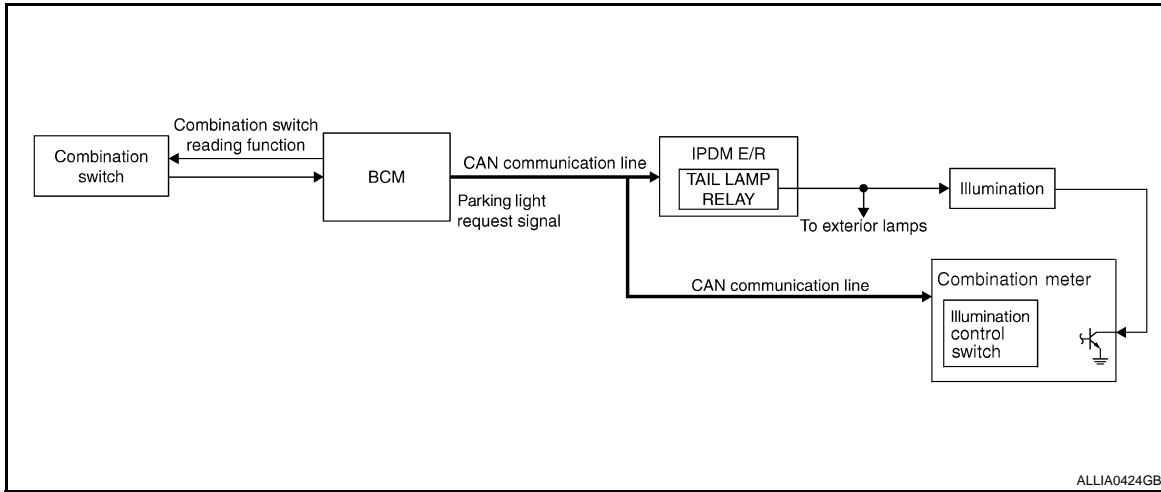

### System Description

INFOID:000000001830317

The illumination lamps operation is dependent upon the position of the lighting switch (combination switch). When the lighting switch is placed in the 1ST or 2ND position (or if the auto light system is activated) the BCM (body control module) receives input requesting the illumination lamps to illuminate. This input is communicated to the IPDM E/R (intelligent power distribution module engine room) across the CAN communication lines. The CPU (central processing unit) of the IPDM E/R controls the tail lamp relay coil. When energized, this relay directs power to the illumination lamps, which then illuminate.

### Component Parts Location

INFOID:000000001830318

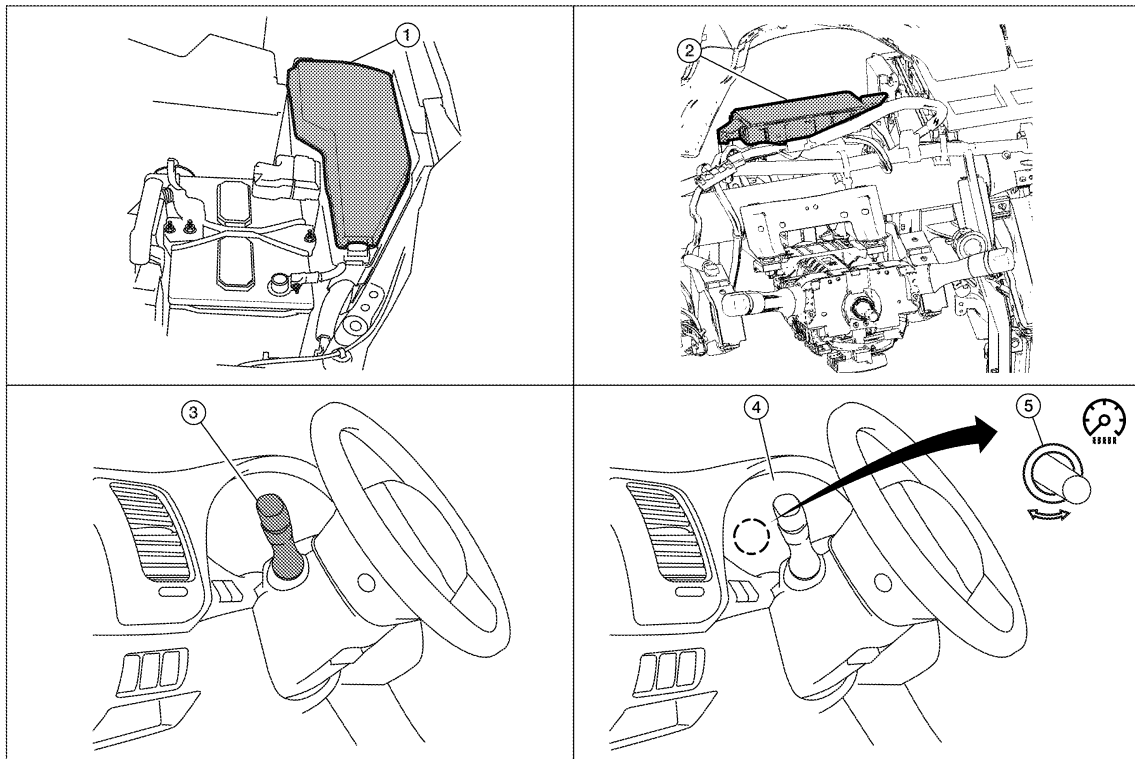

# ILLUMINATION CONTROL SYSTEM

## < FUNCTION DIAGNOSIS >

---

- |                          |  |                           |   |
|--------------------------|--|---------------------------|---|
| 1. IPDM E/R E17, E18     | 2. BCM M16, M17, M18, M19 (view with instrument panel removed) | 3. Combination switch M28 | A |
| 4. Combination meter M24 | 5. Illumination control switch (built into combination meter)  |                           | B |

## Component Description

INFOID:000000001830319

### ILLUMINATION OPERATION BY LIGHTING SWITCH

With the lighting switch in the 1ST or 2ND position (or if the auto light system is activated), the BCM receives input requesting the illumination lamps to illuminate. This input is communicated to the IPDM E/R across the CAN communication lines. The CPU of the IPDM E/R controls the tail lamp relay coil which, when energized, directs power

### BATTERY SAVER CONTROL

When the lighting switch (combination switch) is in the 1ST or 2ND position and the ignition switch is turned from ON or ACC to OFF, the battery saver control feature is activated. Under this condition, the illumination lamps remain illuminated for 30 minutes unless the lighting switch position is changed. If the lighting switch position is changed, then the illumination lamps are turned off after a 30 second delay. When the lighting switch is turned from OFF to 1ST or 2ND position (or if auto light system is activated) after illumination lamps have been turned off by the battery saver control, the illumination lamps illuminate again.

A  
B  
C  
D  
E  
F  
G  
H  
I  
J  
K  
INL  
M  
N  
O  
P

# DIAGNOSIS SYSTEM (BCM)

< FUNCTION DIAGNOSIS >

## DIAGNOSIS SYSTEM (BCM)

### CONSULT-III Function

INFOID:000000001830320

CONSULT-III can display each diagnostic item using the diagnostic test modes shown following.

Diagnostic mode	Description
WORK SUPPORT	Supports inspections and adjustments. Commands are transmitted to the BCM for setting the status suitable for required operation, input/output signals are received from the BCM and received data is displayed.
DATA MONITOR	Displays BCM input/output data in real time.
ACTIVE TEST	Operation of electrical loads can be checked by sending drive signal to them.
SELF-DIAG RESULTS	Displays BCM self-diagnosis results.
CAN DIAG SUPPORT MNTR	The result of transmit/receive diagnosis of CAN communication can be read.
ECU PART NUMBER	BCM part number can be read.
CONFIGURATION	Performs BCM configuration read/write functions.

### WORK SUPPORT

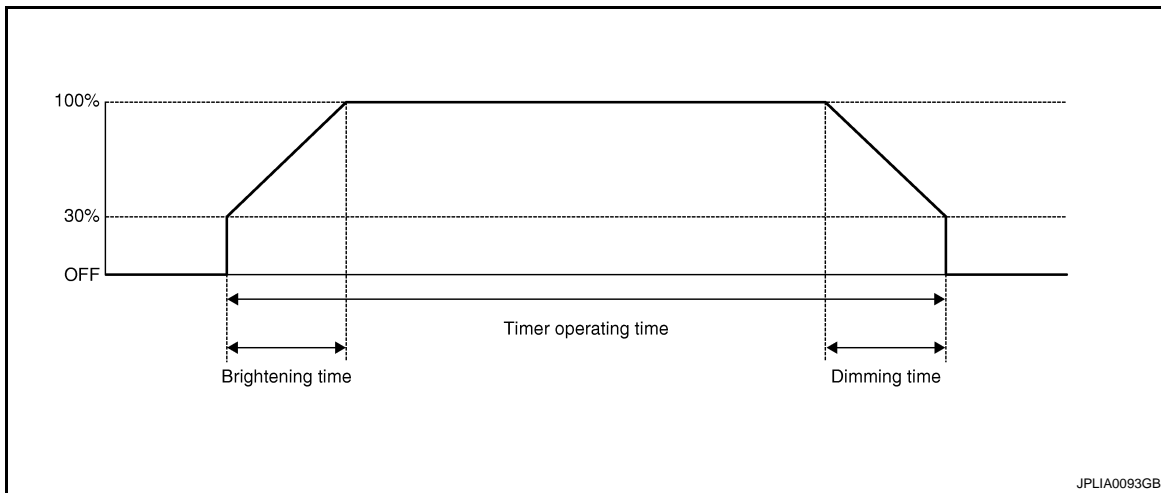

JPLIA0093GB

Service item	Setting item	Setting
SET I/L D-UNLCK INTCON	ON*	With the interior room lamp timer function
	OFF	Without the interior room lamp timer function
ROOM LAMP TIMER SET	MODE 2	7.5 sec.
	MODE 3*	15 sec.
	MODE 4	30 sec.
ROOM LAMP ON TIME SET	MODE 1	0.5 sec.
	MODE 2*	1 sec.
	MODE 3	2 sec.
	MODE 4	3 sec.
	MODE 5	0 sec.
ROOM LAMP OFF TIME SET	MODE 1	0.5 sec.
	MODE 2	1 sec.
	MODE 3	2 sec.
	MODE 4*	3 sec.

# DIAGNOSIS SYSTEM (BCM)

## < FUNCTION DIAGNOSIS >

Service item	Setting item	Setting
R LAMP TIMER LOGIC SET	MODE 1* (ON)	Interior room lamp timer activates with synchronizing all doors.
	MODE 2 (OFF)	Interior room lamp timer activates with synchronizing the front door LH only.

\* : Initial setting

## DATA MONITOR

Monitor item [Unit]	Description
REQ SW-DR [ON/OFF]	The switch status input from request switch (driver side)
REQ SW-AS [ON/OFF]	The switch status input from front request switch (passenger side)
PUSH SW [ON/OFF]	The switch status input from push-button ignition switch
ACC RLY-F/B [ON/OFF]	ACC relay feedback signal status input from ACC relay
UNLK SEN-DR [ON/OFF]	Door lock status input from front door LH
KEY SW-SLOT [ON/OFF]	Key switch status input from key slot
DOOR SW-DR [ON/OFF]	The switch status input from front door switch LH
DOOR SW-AS [ON/OFF]	The switch status input from front door switch RH
DOOR SW-RR [ON/OFF]	The switch status input from rear door switch RH
DOOR SW- RL [ON/OFF]	The switch status input from rear door switch LH
DOOR SW-BK [ON/OFF]	<b>NOTE:</b> The item is indicated, not monitored.
CDL LOCK SW [ON/OFF]	Lock switch status received from central door lock switch by power window switch serial link
CDL UNLOCK SW [ON/OFF]	Unlock switch status received from central door lock switch by power window switch serial link
KEY CYL LK-SW [ON/OFF]	Lock switch status received from key cylinder switch by power window switch serial link
KEY CYL UN-SW [ON/OFF]	Unlock switch status received from key cylinder switch by power window switch serial link
TRNK/HAT MNTR [ON/OFF]	The switch status input from trunk room lamp switch
RKE-LOCK [ON/OFF]	Lock signal status received from remote keyless entry receiver
RKE-UNLOCK [ON/OFF]	Unlock signal status received from remote keyless entry receiver

## ACTIVE TEST

Test item	Operation	Description
INT LAMP	ON	Outputs the interior room lamp control signal to turn map lamp and personal lamp ON (Map lamp switch is in DOOR position).
	OFF	Stops the interior room lamp control signal to turn map lamp and personal lamp OFF.

## DIAGNOSIS SYSTEM (BCM)

### < FUNCTION DIAGNOSIS >

Test item	Operation	Description
STEP LAMP TEST	ON	Outputs the step lamp control signal to turn step lamp ON.
	OFF	Stops the step lamp control signal to turn step lamp OFF.
LUGGAGE LAMP TEST	ON	Outputs the luggage room lamp control signal to turn step lamp ON.
	OFF	Stops the luggage room lamp control signal to turn step lamp ON.

# POWER SUPPLY AND GROUND CIRCUIT

< COMPONENT DIAGNOSIS >

## COMPONENT DIAGNOSIS

POWER SUPPLY AND GROUND CIRCUIT

BCM

BCM : Inspection Procedure

INFOID:000000001830321

POWER SUPPLY AND GROUND CIRCUIT INSPECTION FOR BCM

For information about power and ground circuit inspection for the BCM, refer to [BCS-36, "Diagnosis Procedure"](#).

A

B

C

D

E

F

G

H

I

J

K

INL

M

N

O

P

# INTERIOR ROOM LAMP POWER SUPPLY CIRCUIT

< COMPONENT DIAGNOSIS >

## INTERIOR ROOM LAMP POWER SUPPLY CIRCUIT

### Description

INFOID:000000001830322

Provides the interior room lamp power supply. Also cuts the power supply when the interior room lamp battery saver is activating.

### Component Function Check

INFOID:000000001830323

#### 1. CHECK INTERIOR ROOM LAMP POWER SUPPLY FUNCTION

##### CONSULT-III

1. Turn ignition switch ON.
2. Turn each interior room lamp ON.
  - Front room/map lamps
  - Room lamp (coupe)
  - Personal lamps (sedan)
  - Step lamps
  - Vanity mirror lamps (if equipped)
  - Trunk room lamp
3. Select "BATTERY SAVER" of BCM (BATTERY SAVER) active test item.
4. While operating the test items, check that each interior room lamp turns ON/OFF.

**OFF** : Interior room lamp OFF

**ON** : Interior room lamp ON

Does the interior room lamp turn ON/OFF?

YES >> Interior room lamp power supply circuit is normal.

NO >> Refer to [INL-16, "Diagnosis Procedure"](#).

### Diagnosis Procedure

INFOID:000000001830324

#### 1. CHECK INTERIOR ROOM LAMP POWER SUPPLY OUTPUT

##### CONSULT-III

1. Turn ignition switch ON.
2. Select "BATTERY SAVER" of BCM (BATTERY SAVER) active test item.
3. While operating the test item, check voltage between BCM harness connector M17 terminal 4 and ground.

(+)		(-)	Test item	Voltage
BCM		Ground	BATTERY SAVER	
Connector	Terminal		OFF	0V
M17	4		ON	Battery voltage

Is the measurement value normal?

YES >> GO TO 2

NO >> Replace BCM. Refer to [BCS-88, "Removal and Installation"](#).

#### 2. CHECK INTERIOR ROOM LAMP POWER SUPPLY OPEN CIRCUIT

1. Turn ignition switch OFF.
2. Disconnect the following connectors.
  - BCM M17
  - Front room/map lamp assembly
  - Room lamp (coupe)
  - Vanity mirror lamp LH (if equipped)
  - Vanity mirror lamp RH (if equipped)
  - Trunk room lamp
  - Step lamp LH

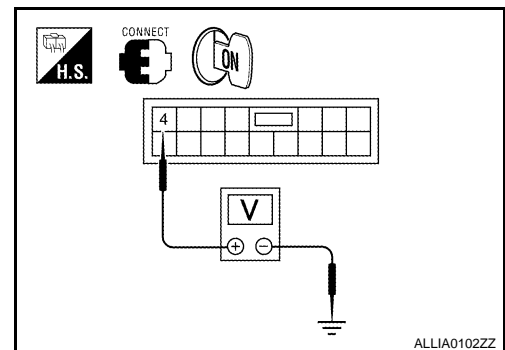



# INTERIOR ROOM LAMP POWER SUPPLY CIRCUIT

## < COMPONENT DIAGNOSIS >

- Step lamp RH
- 3. Check continuity between BCM harness connector M17 terminal 4 and each interior room lamp harness connector.

BCM		Each interior room lamp		Continuity	
Connector	Terminal	Connector	Terminal		
M17	4	Front room/map lamp assembly	R50	1	Yes
		Room lamp (coupe)	R14	1	
		Vanity mirror lamp LH	R3	2	
		Vanity mirror lamp RH	R9	2	
		Trunk room lamp	B36	1	
		Step lamp LH	D11	1	
		Step lamp RH	D109	1	

Does continuity exist?

YES >> GO TO 3

NO >> Repair the harnesses or connectors.

### 3. CHECK INTERIOR ROOM LAMP POWER SUPPLY SHORT CIRCUIT

Check continuity between BCM harness connector M17 terminal 4 and ground.

BCM		Ground	Continuity
Connector	Terminal		
M17	4		No

Does continuity exist?

YES >> Repair the harnesses or connectors.

NO >> Check that each interior room lamp has no internal short circuit.

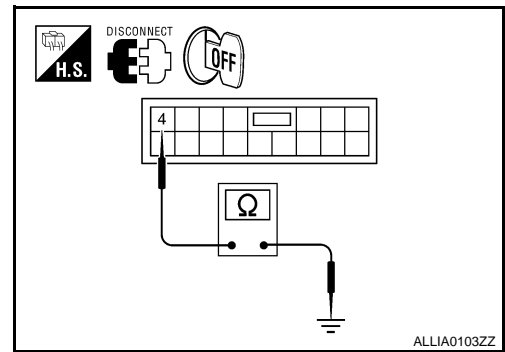

A  
B  
C  
D  
E  
F  
G  
H  
I  
J  
K

INL

M  
N  
O  
P

# INTERIOR ROOM LAMP CONTROL CIRCUIT

< COMPONENT DIAGNOSIS >

## INTERIOR ROOM LAMP CONTROL CIRCUIT

### Description

INFOID:000000001830325

Controls each interior room lamp (ground side) by PWM signal.

**NOTE:**

PWM signal control period is approximately 250 Hz (in the gradual brightening/dimming).

### Component Function Check

INFOID:000000001830326

**CAUTION:**

Before performing the diagnosis, check that the following is normal.

- Interior room lamp power supply
- Front room/map lamp bulbs
- Personal lamp bulbs

### 1. CHECK INTERIOR ROOM LAMP CONTROL FUNCTION

CONSULT-III

1. Switch the map lamp switch to DOOR.
2. Turn ignition switch ON.
3. Select "INT LAMP" of BCM (INT LAMP) active test item.
4. While operating the test items, check that each interior room lamp turns ON/OFF (gradual brightening/dimming).

**ON** : Interior room lamp gradual brightening

**OFF** : Interior room lamp gradual dimming

Do the interior room lamps turn ON/OFF (gradual brightening/dimming)?

- YES >> Interior room lamp control circuit is normal.  
 NO >> Refer to [INL-18. "Diagnosis Procedure"](#).

### Diagnosis Procedure

INFOID:000000001830327

### 1. CHECK INTERIOR ROOM LAMP CONTROL OUTPUT

CONSULT-III

1. Turn ignition switch OFF.
2. Select "INT LAMP" of BCM (INT LAMP) active test item.
3. While operating the test item, check voltage between BCM harness connector M17 terminal 19 and ground.

BCM		Ground	Test item	Voltage
Connector	Terminal		INT LAMP	
M17	19		ON	0V
			OFF	Battery voltage

Are voltage readings as specified?

- YES >> GO TO 2  
 Fixed ON >> GO TO 3  
 Fixed OFF >> Replace BCM. Refer to [BCS-88. "Removal and Installation"](#).

### 2. CHECK INTERIOR ROOM LAMP CONTROL OPEN CIRCUIT

1. Turn ignition switch OFF.
2. Disconnect BCM connector M17, front room/map lamp assembly and room lamp (coupe) connectors.
3. Check continuity between BCM harness connector M17 terminal 19 and each interior room lamp harness connector.

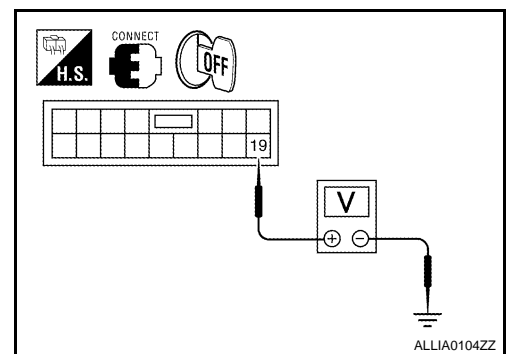

BCM		Interior room lamp		Continuity
Connector	Terminal	Connector	Terminal	

# INTERIOR ROOM LAMP CONTROL CIRCUIT

## < COMPONENT DIAGNOSIS >

M17	19	Front room/map lamp assembly	R50	2	Yes
		Room lamp (coupe)	R14	2	

**Does continuity exist?**

YES >> Replace the front room/map lamp assembly or the room lamp. Refer to [INL-77. "Removal and Installation"](#).

NO >> Repair the harnesses or connectors.

### 3. CHECK INTERIOR ROOM LAMP CONTROL SHORT CIRCUIT

1. Turn ignition switch OFF.
2. Disconnect BCM connector M17 and front room/map lamp assembly harness connectors.
3. Check continuity between BCM harness connector M17 terminal 19 and ground.

BCM		Ground	Continuity
Connector	Terminal		No
M17	19		No

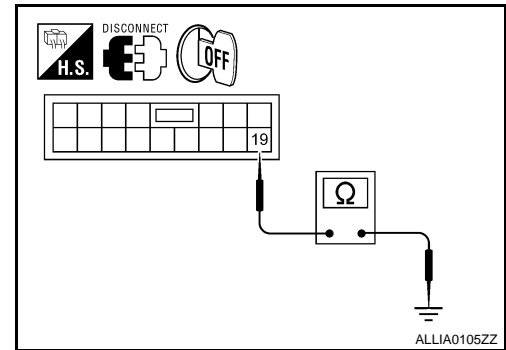

**Does continuity exist?**

YES >> Repair the harnesses or connectors.

NO >> Replace BCM. Refer to [BCS-88. "Removal and Installation"](#).

A  
B  
C  
D  
E  
F  
G  
H  
I  
J  
K  
L  
M  
N  
O  
P

INL

# STEP LAMP CIRCUIT

< COMPONENT DIAGNOSIS >

## STEP LAMP CIRCUIT

### Description

INFOID:000000001830328

Controls the step lamp (ground side) to turn the step lamp ON and OFF.

### Component Function Check

INFOID:000000001830329

#### CAUTION:

Before performing the diagnosis, check that the following is normal.

- Interior room lamp power supply
- Step lamp bulb

### 1.CHECK STEP LAMP OPERATION

#### CONSULT-III

1. Turn ignition switch ON.
2. Select "STEP LAMP TEST" of BCM (INT LAMP) active test item.
3. While operating the test items, check that step lamp turns ON/OFF.

**ON** : Step lamp ON  
**OFF** : Step lamp OFF

#### Does the step lamp turn ON/OFF?

- YES >> Step lamp circuit is operating.  
 NO >> Refer to [INL-20, "Diagnosis Procedure"](#).

### Diagnosis Procedure

INFOID:000000001830330

### 1.CHECK STEP LAMP OUTPUT

#### CONSULT-III

1. Turn ignition switch ON.
2. Select "STEP LAMP TEST" of BCM (INT LAMP) active test item.
3. While operating the test item, check voltage between BCM harness connector M17 terminal 7 and ground.

BCM		Ground	Test item	Voltage
Connector	Terminal		STEP LAMP TEST	
M17	7		ON	0V
			OFF	Battery voltage

#### Are the voltage readings as specified?

- YES >> GO TO 2  
 Fixed ON>>GO TO 3  
 Fixed OFF>> Replace BCM. Refer to [BCS-88, "Removal and Installation"](#).

### 2.CHECK STEP LAMP OPEN CIRCUIT

1. Turn ignition switch OFF.
2. Disconnect BCM connector M17 and step lamp LH and RH connector.
3. Check continuity between BCM harness connector M17 (A) terminal 7 and step lamp harness connector (B) terminal 2.

BCM		Step lamp			Continuity
Connector	Terminal	Connector	Terminal	Terminal	
M17 (A)	7	LH	D11 (B)	2	Yes
		RH	D109 (B)	2	

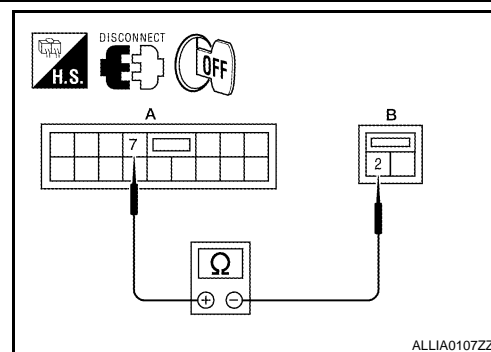
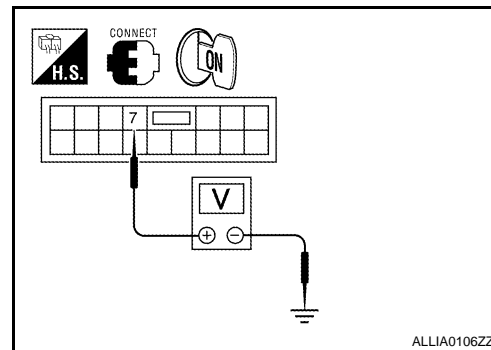

# STEP LAMP CIRCUIT

## < COMPONENT DIAGNOSIS >

### Does continuity exist?

YES >> Replace step lamp. Refer to [INL-77, "Removal and Installation"](#).

NO >> Repair harnesses or connectors.

### 3. CHECK STEP LAMP SHORT CIRCUIT

1. Turn ignition switch OFF.
2. Disconnect BCM connector M17 and step lamp LH and RH connectors.
3. Check continuity between BCM harness connector M17 terminal 7 and ground.

BCM		Ground	Continuity
Connector	Terminal		
M17	7		No

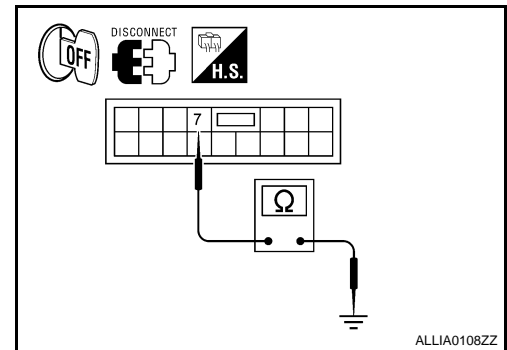

### Does continuity exist?

YES >> Repair the harnesses or connectors.

NO >> Replace BCM. Refer to [BCS-88, "Removal and Installation"](#).

A  
B  
C  
D  
E  
F  
G  
H  
I  
J  
K  
L  
M  
N  
O  
P

INL

# TRUNK ROOM LAMP CIRCUIT

< COMPONENT DIAGNOSIS >

## TRUNK ROOM LAMP CIRCUIT

### Description

INFOID:000000001830331

Controls the trunk room lamp (ground side) to turn the trunk room lamp ON and OFF.

### Component Function Check

INFOID:000000001830332

#### CAUTION:

Before performing the diagnosis, check that the following is normal.

- Interior room lamp power supply
- Trunk room lamp bulb

### 1.CHECK TRUNK ROOM LAMP OPERATION

#### CONSULT-III

1. Turn ignition switch ON.
2. Select "LUGGAGE LAMP TEST" of BCM (INT LAMP) active test item.
3. While operating the test items, check that trunk room lamp turns ON/OFF.

**ON** : Trunk room lamp ON

**OFF** : Trunk room lamp OFF

#### Does the trunk room lamp turn ON/OFF?

YES >> Trunk room lamp circuit is normal.

NO >> Refer to [INL-20, "Diagnosis Procedure"](#).

### Diagnosis Procedure

INFOID:000000001830333

### 1.CHECK TRUNK ROOM LAMP OUTPUT

#### CONSULT-III

1. Turn ignition switch ON.
2. Select "LUGGAGE LAMP TEST" of BCM (INT LAMP) active test item.
3. While operating the test item, check voltage between BCM harness connector M20 terminal 110 and ground.

BCM		Ground	Test item	Voltage
Connector	Terminal		LUGGAGE LAMP TEST	
M20	110		ON	0V
			OFF	Battery voltage

#### Are the voltage readings as specified?

YES >> GO TO 2

Fixed ON>>GO TO 3

Fixed OFF>> Replace BCM. Refer to [BCS-88, "Removal and Installation"](#).

### 2.CHECK TRUNK ROOM LAMP OPEN CIRCUIT

1. Turn ignition switch OFF.
2. Disconnect BCM connector M20 and trunk room lamp connector.
3. Check continuity between BCM harness connector M20 (A) terminal 110 and trunk room lamp harness connector B36 (B) terminal 2.

BCM		Trunk room lamp		Continuity
Connector	Terminal	Connector	Terminal	
M20	110	B36	2	Yes

#### Does continuity exist?

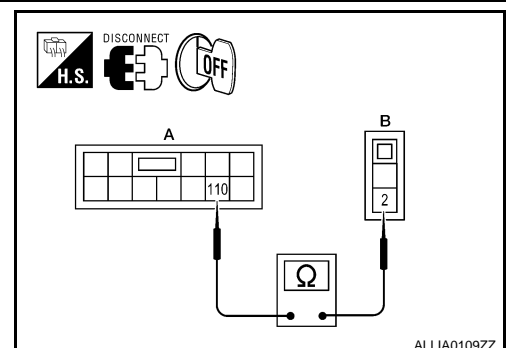
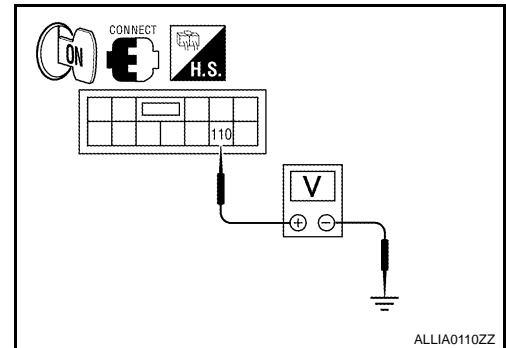

# TRUNK ROOM LAMP CIRCUIT

## < COMPONENT DIAGNOSIS >

YES >> Replace trunk room lamp. Refer to [INL-77. "Removal and Installation"](#).

NO >> Repair harnesses or connectors.

### 3. CHECK TRUNK ROOM LAMP SHORT CIRCUIT

1. Turn ignition switch OFF.
2. Disconnect BCM connector M20 and trunk room lamp connector.
3. Check continuity between BCM harness connector M20 terminal 110 and ground.

BCM		Ground	Continuity
Connector	Terminal		
M20	110		No

Does continuity exist?

YES >> Repair harnesses or connectors.

NO >> Replace BCM. Refer to [BCS-88. "Removal and Installation"](#).

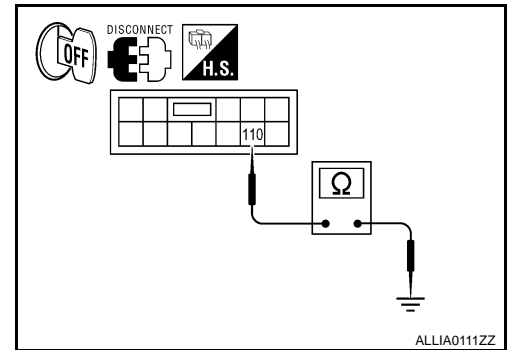

A  
B  
C  
D  
E  
F  
G  
H  
I  
J  
K  
L  
M  
N  
O  
P

INL

# PUSH-BUTTON IGNITION SWITCH ILLUMINATION CIRCUIT

< COMPONENT DIAGNOSIS >

## PUSH-BUTTON IGNITION SWITCH ILLUMINATION CIRCUIT

### Description

INFOID:000000001830334

Provides the power supply and the ground to control the push-button ignition switch illumination.

### Component Function Check

INFOID:000000001830335

### 1.CHECK PUSH-BUTTON IGNITION SWITCH ILLUMINATION OPERATION

#### CONSULT-III

1. Turn the ignition switch ON.
2. Select "ENGINE SW ILLUMI" of BCM (INTELLGENT KEY) active test item.
3. While operating the test items, check that the push-button ignition switch illumination turns ON/OFF

**ON : Push-button ignition switch illumination ON**

**OFF : Push-button ignition switch illumination OFF**

Does the push-button ignition switch illumination turn ON/OFF?

- YES >> Push-button ignition switch illumination circuit is normal.  
 NO >> Refer to [INL-24, "Diagnosis Procedure"](#).

### Diagnosis Procedure

INFOID:000000001830336

### 1.CHECK ILLUMINATION CONTROL SWITCHING OPERATION

1. Turn the ignition switch ON.
2. While operating the lighting switch, check that the push-button ignition switch illumination turns ON/OFF

Condition	Push-button ignition switch illumination
<ul style="list-style-type: none"> <li>• Ignition switch ON</li> <li>• Lighting switch 1ST</li> </ul>	ON
<ul style="list-style-type: none"> <li>• Ignition switch OFF</li> <li>• Lighting switch OFF</li> <li>• Driver door LOCK</li> </ul>	OFF

Does the push-button ignition switch illumination turn ON/OFF?

- YES >> GO TO 2  
 NO >> GO TO 3

### 2.CHECK PUSH-BUTTON IGNITION SWITCH ILLUMINATION GROUND CIRCUIT

1. Turn the ignition switch OFF.
2. Disconnect BCM connector M17 and the push-button ignition switch connector.
3. Check continuity between BCM harness connector M17 (A) terminal 14 and the push-button ignition switch harness connector M38 (B) terminal 2.

BCM		Push-button ignition switch		Continuity
Connector	Terminal	Connector	Terminal	
M17 (A)	14	M38 (B)	2	Yes

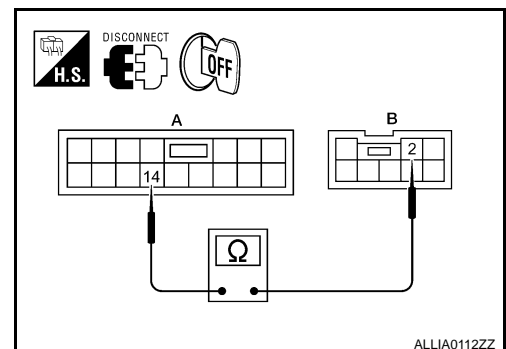

ALLIA0112ZZ

Does continuity exist?

- YES >> Replace BCM. Refer to [BCS-88, "Removal and Installation"](#).  
 NO >> Repair the harness or the connector.

### 3.CHECK PUSH-BUTTON IGNITION SWITCH ILLUMINATION POWER SUPPLY OUTPUT

#### CONSULT-III

1. Turn the ignition switch ON.
2. Select "ENGINE SW ILLUMI" of BCM (INTELLIGENT KEY) active test item.



# PUSH-BUTTON IGNITION SWITCH ILLUMINATION CIRCUIT

## < COMPONENT DIAGNOSIS >

- While operating the test item, check voltage between BCM harness connector M18 terminal 41 and ground.

Terminals		Test item	Voltage
(+)	(-)		
BCM		ENGINE SW ILLUMI	
Connector	Terminal		
M18	41	ON	5V
		OFF	0V

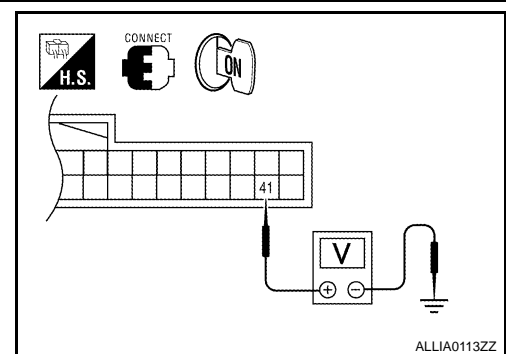

Is the measurement value normal?

- YES >> GO TO 4  
NO >> GO TO 5

## 4. CHECK PUSH-BUTTON IGNITION SWITCH ILLUMINATION POWER SUPPLY OPEN CIRCUIT

- Turn the ignition switch OFF.
- Disconnect BCM connector M18 and the push-button ignition switch connector.
- Check continuity between BCM harness connector M18 (A) terminal 41 and the push-button ignition switch harness connector M38 (B) terminal 3.

BCM		Push-button ignition switch		Continuity
Connector	Terminal	Connector	Terminal	
M18 (A)	41	M38 (B)	3	Yes

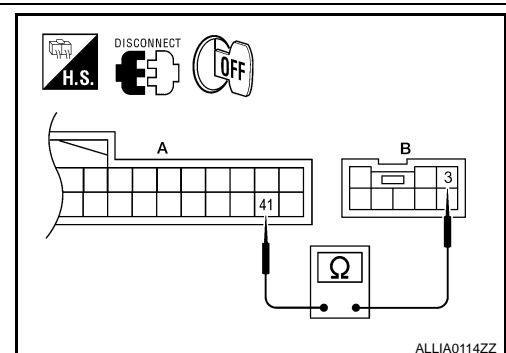

Does continuity exist?

- YES >> Replace push-button ignition switch.  
NO >> Repair the harness or the connector.

## 5. CHECK PUSH-BUTTON IGNITION SWITCH ILLUMINATION POWER SUPPLY SHORT CIRCUIT

- Turn the ignition switch OFF.
- Disconnect BCM connector M18 and the push-button ignition switch connector.
- Check continuity between BCM harness connector M18 terminal 41 and ground.

BCM		Ground	Continuity
Connector	Terminal		
M18	41		No

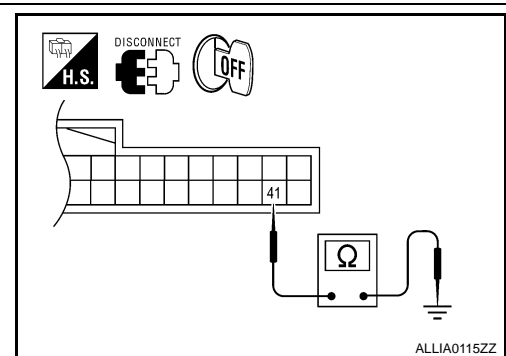

Does continuity exist?

- YES >> Repair the harness or the connector.  
NO >> Replace BCM. Refer to [BCS-88. "Removal and Installation"](#).

A  
B  
C  
D  
E  
F  
G  
H  
I  
J  
K  
INL  
M  
N  
O  
P

# INTERIOR ROOM LAMP CONTROL SYSTEM

< COMPONENT DIAGNOSIS >

## INTERIOR ROOM LAMP CONTROL SYSTEM

Wiring Diagram - Coupe

INFOID:000000001830337

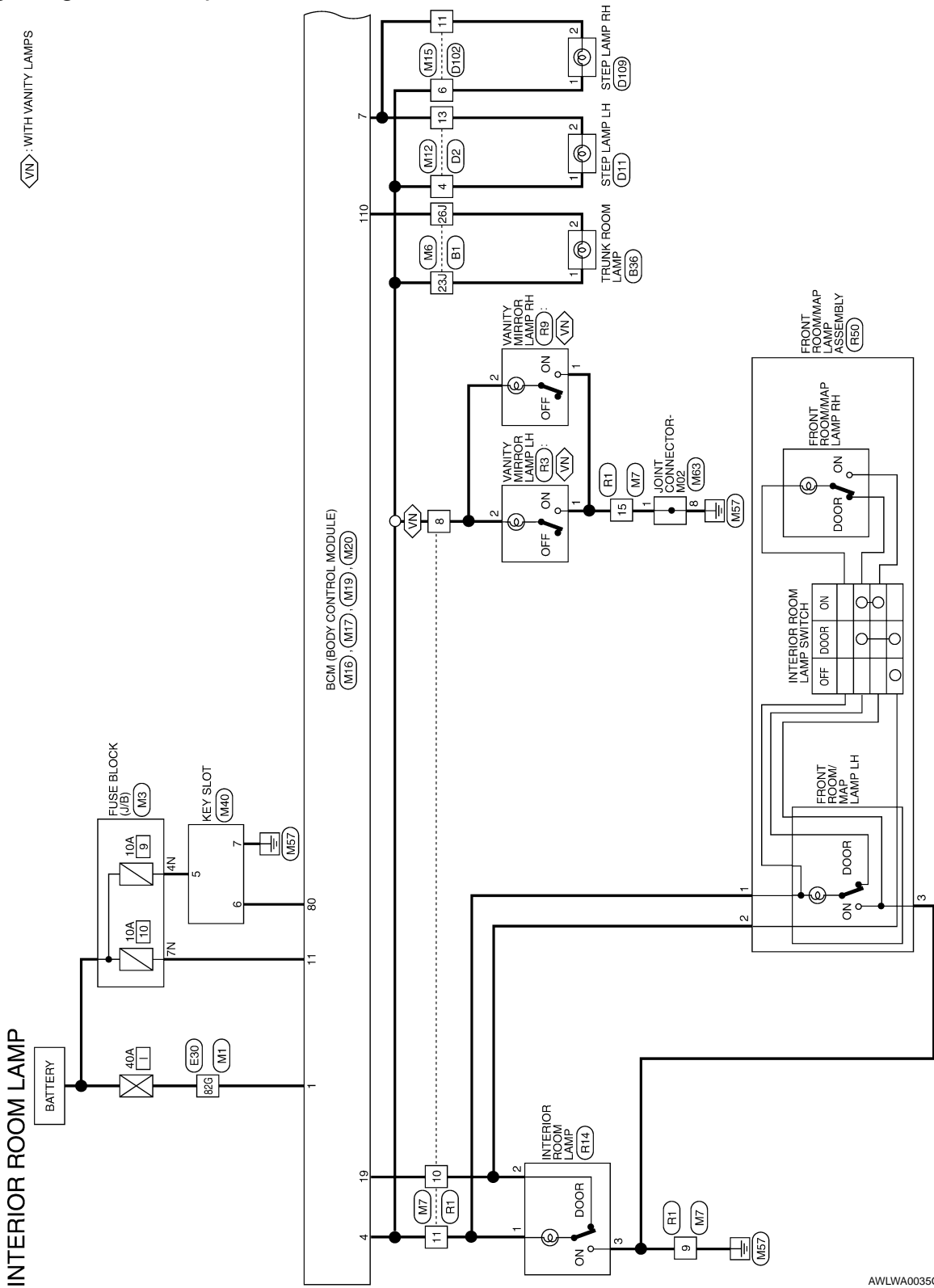

AWLWA0035GE

# INTERIOR ROOM LAMP CONTROL SYSTEM

## < COMPONENT DIAGNOSIS >

◊A6◊ : WITH LEFT POWER WINDOW ANTI-PINCH SYSTEM  
 ◊A7◊ : WITH LEFT AND RIGHT POWER WINDOW ANTI-PINCH SYSTEM  
 - - - : DATA LINE

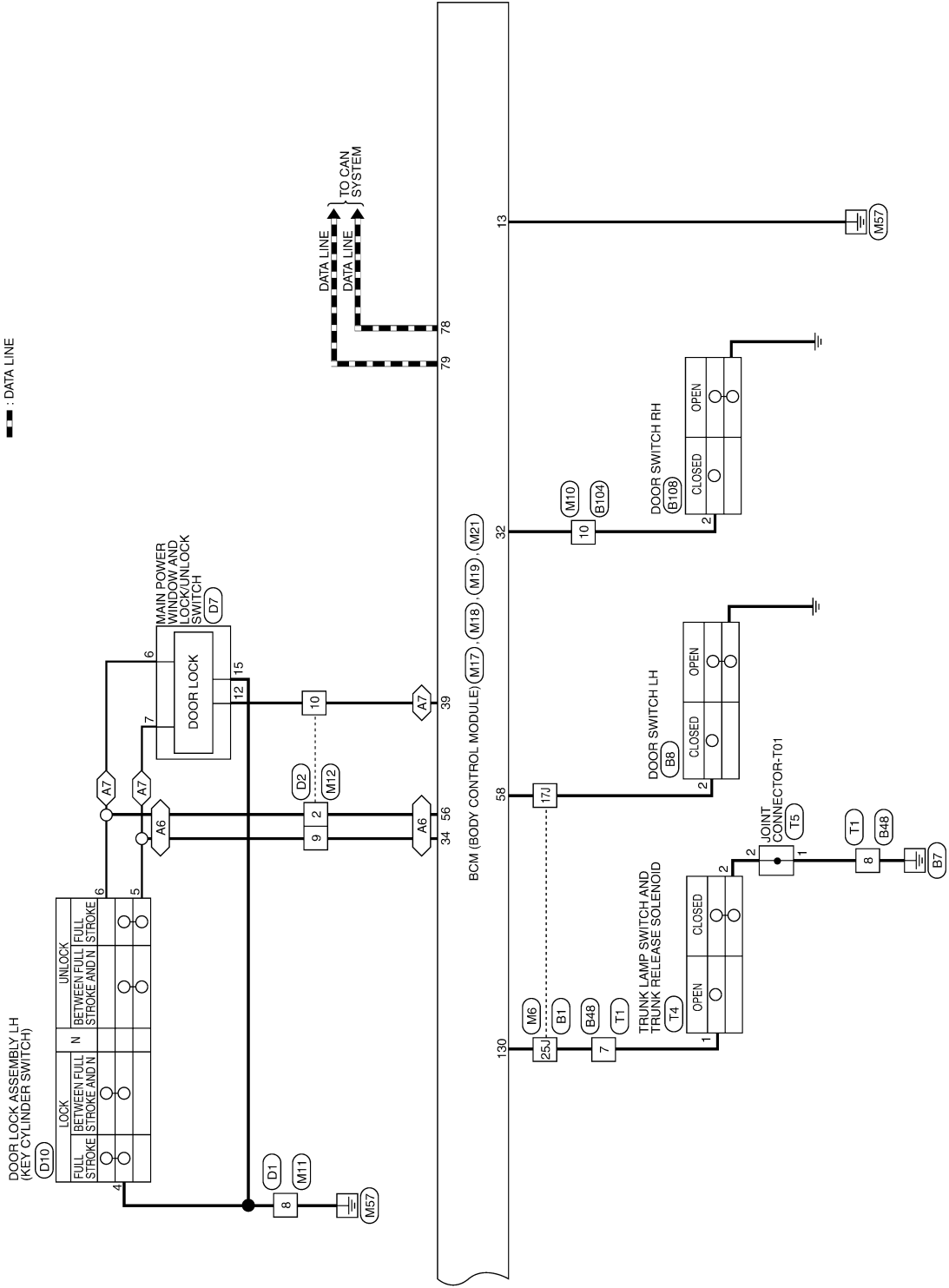

AWLWA0036GE

A  
B  
C  
D  
E  
F  
G  
H  
I  
J  
K  
INL  
M  
N  
O  
P

# INTERIOR ROOM LAMP CONTROL SYSTEM

< COMPONENT DIAGNOSIS >

## INTERIOR ROOM LAMP CONNECTORS

Connector No.	M1
Connector Name	WIRE TO WIRE
Connector Color	WHITE

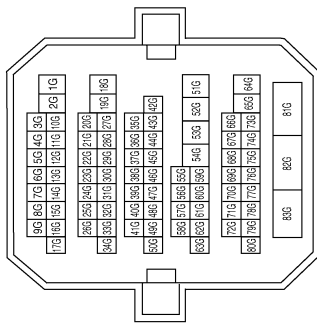

Terminal No.	82G	Color of Wire	W/B	Signal Name	—
--------------	-----	---------------	-----	-------------	---

Connector No.	M3
Connector Name	FUSE BLOCK (J/B)
Connector Color	WHITE

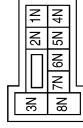

Terminal No.	Color of Wire	Signal Name
4N	G/Y	—
7N	Y/R	—

Connector No.	M6
Connector Name	WIRE TO WIRE
Connector Color	WHITE

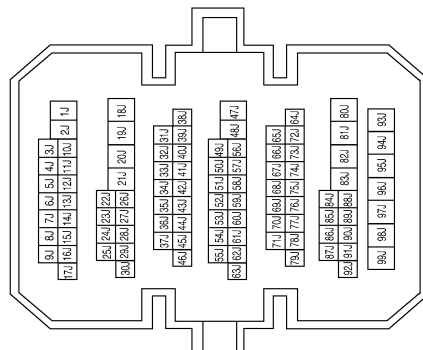

Terminal No.	17J	Color of Wire	SB	Signal Name	—
	23J	P/W	—	—	—
	25J	Y/G	—	—	—
	26J	V/W	—	—	—

Connector No.	M7
Connector Name	WIRE TO WIRE
Connector Color	WHITE

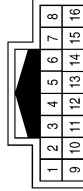

Terminal No.	Color of Wire	Signal Name
8	P/W	—
9	B	—
10	Y	—
11	P/W	—
15	B	—

# INTERIOR ROOM LAMP CONTROL SYSTEM

## < COMPONENT DIAGNOSIS >

Connector No.	M12
Connector Name	WIRE TO WIRE
Connector Color	WHITE

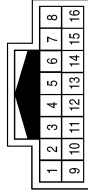

Terminal No.	Color of Wire	Signal Name
2	L/B	—
4	P/W	—
9	L/R	—
10	Y/G	—
13	R/W	—

Connector No.	M11
Connector Name	WIRE TO WIRE
Connector Color	WHITE

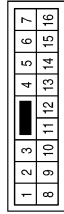

Terminal No.	Color of Wire	Signal Name
8	B	—

Connector No.	M10
Connector Name	WIRE TO WIRE
Connector Color	BROWN

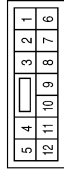

Terminal No.	Color of Wire	Signal Name
10	R/B	—

Connector No.	M17
Connector Name	BCM (BODY CONTROL MODULE)
Connector Color	WHITE



Terminal No.	Color of Wire	Signal Name
4	P/W	ROOM_LAMP_BAT_SAVER
7	R/W	STEP_LAMP_OUTPUT
11	Y/R	BAT_BCM_FUSE
13	B	GND1
19	Y	ROOM_LAMP_OUTPUT

Connector No.	M16
Connector Name	BCM (BODY CONTROL MODULE)
Connector Color	BLACK



Terminal No.	Color of Wire	Signal Name
1	W/B	BAT_POWER_F/L

Connector No.	M15
Connector Name	WIRE TO WIRE
Connector Color	WHITE

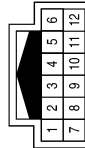

Terminal No.	Color of Wire	Signal Name
6	P/W	—
11	R/W	—

AWLIA0175GB

# INTERIOR ROOM LAMP CONTROL SYSTEM

## < COMPONENT DIAGNOSIS >

Connector No.	M20
Connector Name	BCM (BODY CONTROL MODULE)
Connector Color	WHITE

100	101	102	103	104
105	106	107	108	109
110	111			



Terminal No.	Color of Wire	Signal Name
110	V/W	TRUNK_LAMP_-- OUTPUT

Connector No.	M19
Connector Name	BCM (BODY CONTROL MODULE)
Connector Color	BLACK

79	78	77	76	75	74	73	72	71	70	69	68	67	66	65	64	63	62	61	60
99	98	97	96	95	94	93	92	91	90	89	88	87	86	85	84	83	82	81	80



Terminal No.	Color of Wire	Signal Name
78	P	CAN-L
79	L	CAN-H
80	R/L	FOB_SLOT_ILLUMINATION

Connector No.	M18
Connector Name	BCM (BODY CONTROL MODULE)
Connector Color	GREEN

39	38	37	36	35	34	33	32	31	30	29	28	27	26	25	24	23	22	21	20
59	58	57	56	55	54	53	52	51	50	49	48	47	46	45	44	43	42	41	40



Terminal No.	Color of Wire	Signal Name
32	R/B	AS_DOOR_SW
34	L/R	DOOR_KEY/C UNLOCK_SW
40	Y/G	PW_K-LINE
56	L/B	DOOR_KEY/C_-- LOCK_SW
58	SB	DR_DOOR_SW

Connector No.	M63
Connector Name	JOINT CONNECTOR-M02
Connector Color	BLUE

12	11	10	9	8	7	6	5	4	3	2	1
----	----	----	---	---	---	---	---	---	---	---	---



Terminal No.	Color of Wire	Signal Name
1	B	---
8	B	---

Connector No.	M40
Connector Name	KEY SLOT
Connector Color	WHITE

1	2	3	4	5	6
7	8	9	10	11	12



Terminal No.	Color of Wire	Signal Name
5	G/Y	LIGHT_BAT+
6	R/L	LIGHT_A
7	B	GND

Connector No.	M21
Connector Name	BCM (BODY CONTROL MODULE)
Connector Color	GRAY

131	130	129	128	127	126	125	124	123	122	121	120	119	118	117	116	115	114	113	112
151	150	149	148	147	146	145	144	143	142	141	140	139	138	137	136	135	134	133	132



Terminal No.	Color of Wire	Signal Name
130	Y/G	TRUNK_SW

# INTERIOR ROOM LAMP CONTROL SYSTEM

## < COMPONENT DIAGNOSIS >

Terminal No.	Color of Wire	Signal Name
17J	SB	—
22J	R/B	—
23J	P	—
25J	Y/G	—
26J	V/W	—

Connector No.	B1
Connector Name	WIRE TO WIRE
Connector Color	WHITE

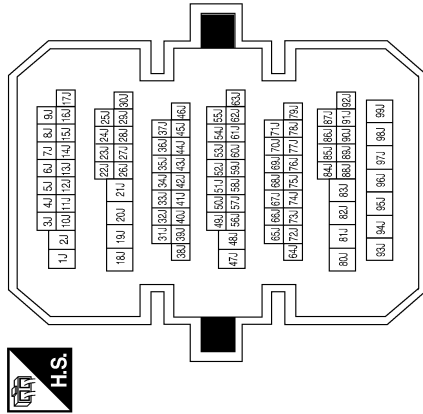

Connector No.	E30
Connector Name	WIRE TO WIRE
Connector Color	WHITE

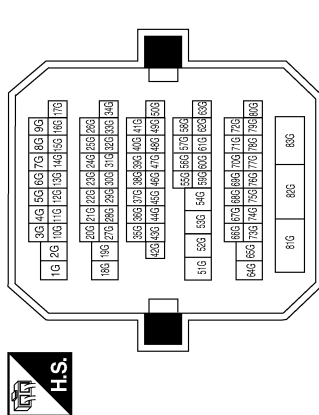

Terminal No.	Color of Wire	Signal Name
82G	W/B	—

Connector No.	B48
Connector Name	WIRE TO WIRE
Connector Color	WHITE

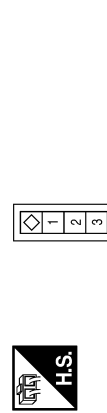

Terminal No.	Color of Wire	Signal Name
7	Y/G	—
8	B	—

Connector No.	B36
Connector Name	TRUNK ROOM LAMP
Connector Color	WHITE

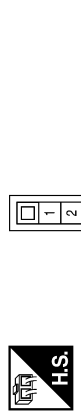

Terminal No.	Color of Wire	Signal Name
1	P	—
2	V/W	—

Connector No.	B8
Connector Name	DOOR SWITCH LH
Connector Color	WHITE

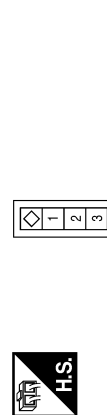

Terminal No.	Color of Wire	Signal Name
2	SB	DOOR SW(DR)

AWLIA0177GB

A  
B  
C  
D  
E  
F  
G  
H  
I  
J  
K  
L  
M  
N  
O  
P

INL

# INTERIOR ROOM LAMP CONTROL SYSTEM

## < COMPONENT DIAGNOSIS >

Connector No.	T1
Connector Name	WIRE TO WIRE
Connector Color	WHITE

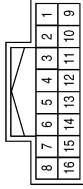

Terminal No.	Color of Wire	Signal Name
7	Y/G	—
8	B	—

Connector No.	B108
Connector Name	DOOR SWITCH RH
Connector Color	WHITE

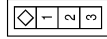

Terminal No.	Color of Wire	Signal Name
2	R/B	DOOR SW (AS)

Connector No.	B104
Connector Name	WIRE TO WIRE
Connector Color	BROWN

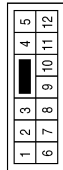

Terminal No.	Color of Wire	Signal Name
10	R/B	—

Connector No.	R1
Connector Name	WIRE TO WIRE
Connector Color	WHITE

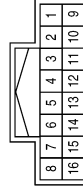

Terminal No.	Color of Wire	Signal Name
8	P	—
9	W	—
10	W	—
11	W	—
15	B	—

Connector No.	T5
Connector Name	JOINT CONNECTOR-T01
Connector Color	WHITE



Terminal No.	Color of Wire	Signal Name
1	B	—
2	B	—

Connector No.	T4
Connector Name	TRUNK LAMP SWITCH AND TRUNK RELEASE SOLENOID
Connector Color	WHITE



Terminal No.	Color of Wire	Signal Name
1	Y/G	—
2	B	—

AWLIA0178GB



# INTERIOR ROOM LAMP CONTROL SYSTEM

## < COMPONENT DIAGNOSIS >

Connector No.	R14
Connector Name	INTERIOR ROOM LAMP
Connector Color	—

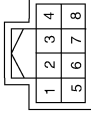

Terminal No.	Color of Wire	Signal Name
1	W	—
3	W	—
4	R	—

Connector No.	R9
Connector Name	VANITY MIRROR LAMP RH
Connector Color	WHITE



Terminal No.	Color of Wire	Signal Name
1	B	GND
2	P	ROOM_LAMP_BAT_SAVER

Connector No.	R3
Connector Name	VANITY MIRROR LAMP LH
Connector Color	WHITE



Terminal No.	Color of Wire	Signal Name
1	B	GND
2	P	ROOM_LAMP_BAT_SAVER

Connector No.	D2
Connector Name	WIRE TO WIRE
Connector Color	WHITE

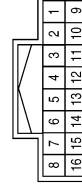

Terminal No.	Color of Wire	Signal Name
2	L/B	—
4	P/W	—
9	L/R	—
10	Y/G	—
13	R/W	—

Connector No.	D1
Connector Name	WIRE TO WIRE
Connector Color	WHITE

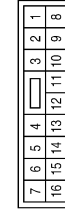

Terminal No.	Color of Wire	Signal Name
8	B	—

Connector No.	R50
Connector Name	FRONT ROOM/MAP LAMP ASSEMBLY
Connector Color	GRAY

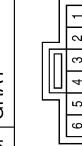

Terminal No.	Color of Wire	Signal Name
1	W	—
2	W	—
3	W	—

AWLIA0179GB

# INTERIOR ROOM LAMP CONTROL SYSTEM

## < COMPONENT DIAGNOSIS >

Connector No.	D7
Connector Name	MAIN POWER WINDOW AND LOCK/UNLOCK SWITCH (WITH LEFT AND RIGHT POWER WINDOW ANTI-PINCH SYSTEM)
Connector Color	WHITE

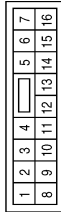

Terminal No.	Color of Wire	Signal Name
6	L/B	LOCK
7	L/R	UNLOCK
12	Y/G	COM
15	B	GND

Connector No.	D7
Connector Name	MAIN POWER WINDOW AND LOCK/UNLOCK SWITCH (WITH LEFT POWER WINDOW ANTI-PINCH SYSTEM)
Connector Color	WHITE

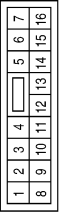

Terminal No.	Color of Wire	Signal Name
6	GR/R	UNLOCK

Connector No.	D10
Connector Name	DOOR LOCK ASSEMBLY LH
Connector Color	GRAY

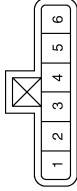

Terminal No.	Color of Wire	Signal Name
4	B	GND
5	L/R	DOOR_KEY/C_ UNLOCK_SW
6	L/B	DOOR_KEY/C_ LOCK_SW

Connector No.	D11
Connector Name	STEP LAMP LH
Connector Color	WHITE



Terminal No.	Color of Wire	Signal Name
1	P/W	—
2	R/W	—

Connector No.	D102
Connector Name	WIRE TO WIRE
Connector Color	WHITE

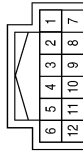

Terminal No.	Color of Wire	Signal Name
6	P/W	—
11	R/W	—

Connector No.	D109
Connector Name	STEP LAMP RH
Connector Color	WHITE



Terminal No.	Color of Wire	Signal Name
1	P/W	—
2	R/W	—

# INTERIOR ROOM LAMP CONTROL SYSTEM

## < COMPONENT DIAGNOSIS >

Connector No.	D7
Connector Name	MAIN POWER WINDOW AND LOCK/UNLOCK SWITCH (WITH LEFT AND RIGHT POWER WINDOW ANTI-PINCH SYSTEM)
Connector Color	WHITE

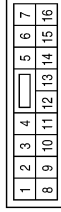

Terminal No.	Color of Wire	Signal Name
6	L/B	LOCK
7	L/R	UNLOCK
12	Y/G	COM
15	B	GND

Connector No.	D2
Connector Name	WIRE TO WIRE
Connector Color	WHITE

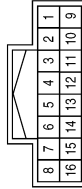

Terminal No.	Color of Wire	Signal Name
2	L/B	—
4	P/W	—
9	L/R	—
10	Y/G	—
13	R/W	—

Connector No.	D1
Connector Name	WIRE TO WIRE
Connector Color	WHITE

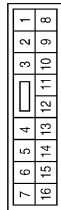

Terminal No.	Color of Wire	Signal Name
8	B	—

Connector No.	D11
Connector Name	STEP LAMP LH
Connector Color	WHITE



Terminal No.	Color of Wire	Signal Name
1	P/W	—
2	R/W	—

Connector No.	D10
Connector Name	DOOR LOCK ASSEMBLY LH
Connector Color	GRAY

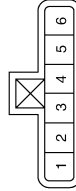

Terminal No.	Color of Wire	Signal Name
4	B	GND
5	L/R	DOOR_KEY/C_UNLOCK_SW
6	L/B	DOOR_KEY/C_LOCK_SW

Connector No.	D7
Connector Name	MAIN POWER WINDOW AND LOCK/UNLOCK SWITCH (WITH LEFT POWER WINDOW ANTI-PINCH SYSTEM)
Connector Color	WHITE



Terminal No.	Color of Wire	Signal Name
6	GR/R	UNLOCK

AWLIA0181GB



# INTERIOR ROOM LAMP CONTROL SYSTEM

## < COMPONENT DIAGNOSIS >

---

Connector No.	D109
Connector Name	STEP LAMP RH
Connector Color	WHITE



Terminal No.	Color of Wire	Signal Name
1	P/W	—
2	R/W	—

Connector No.	D102
Connector Name	WIRE TO WIRE
Connector Color	WHITE

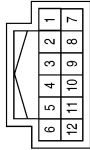

Terminal No.	Color of Wire	Signal Name
6	P/W	—
11	R/W	—

ALJIA0046GB

# INTERIOR ROOM LAMP CONTROL SYSTEM

< COMPONENT DIAGNOSIS >

Wiring Diagram - Sedan

INFOID:000000003185301

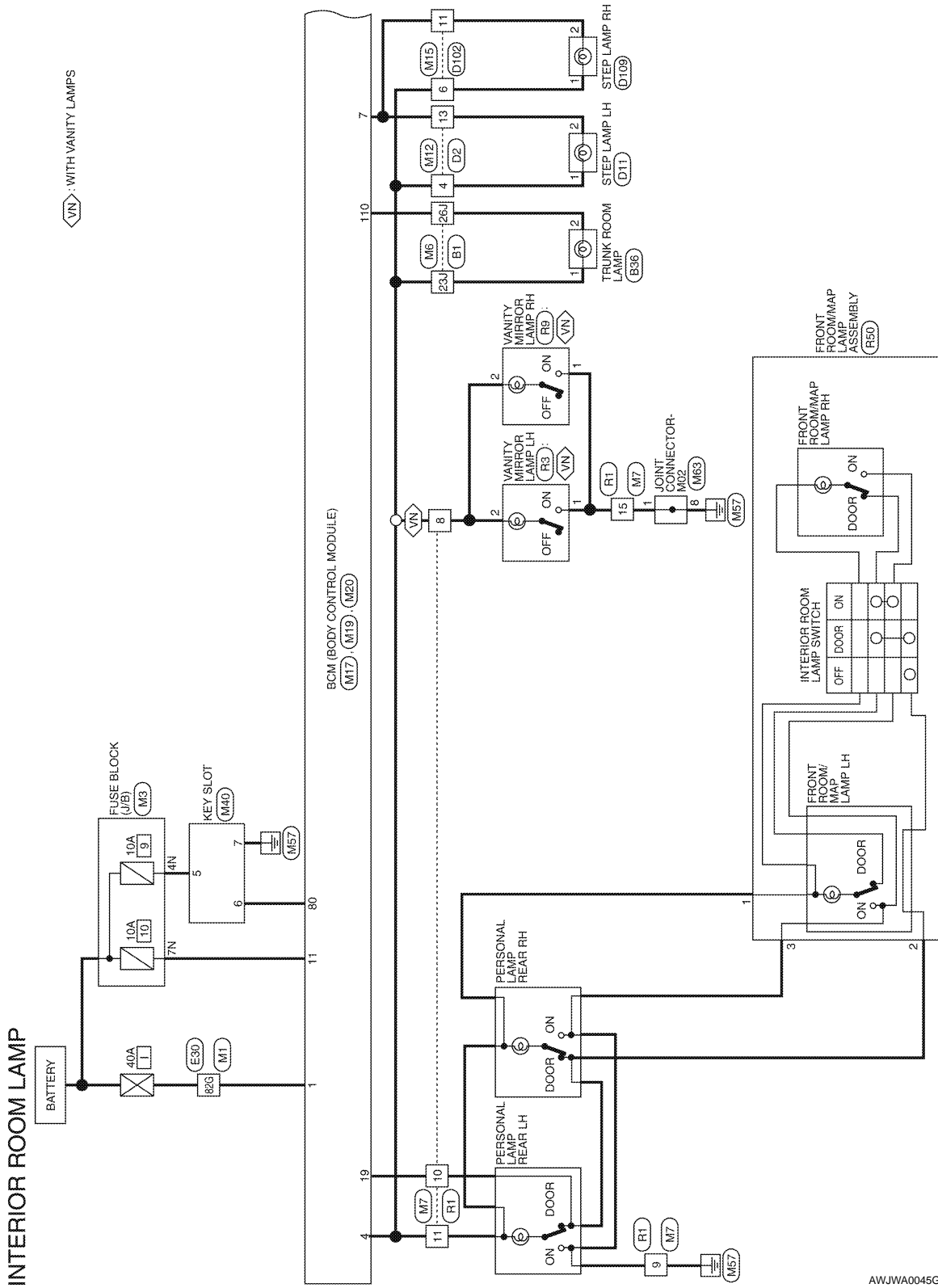

AWJWA0045GE

A  
B  
C  
D  
E  
F  
G  
H  
I  
J  
K  
L  
M  
N  
O  
P

INL

# INTERIOR ROOM LAMP CONTROL SYSTEM

## < COMPONENT DIAGNOSIS >

-  : WITH LEFT FRONT ONLY POWER WINDOW ANTI-PINCH SYSTEM
-  : WITH LEFT AND RIGHT FRONT POWER WINDOW ANTI-PINCH SYSTEM
-  : DATA LINE

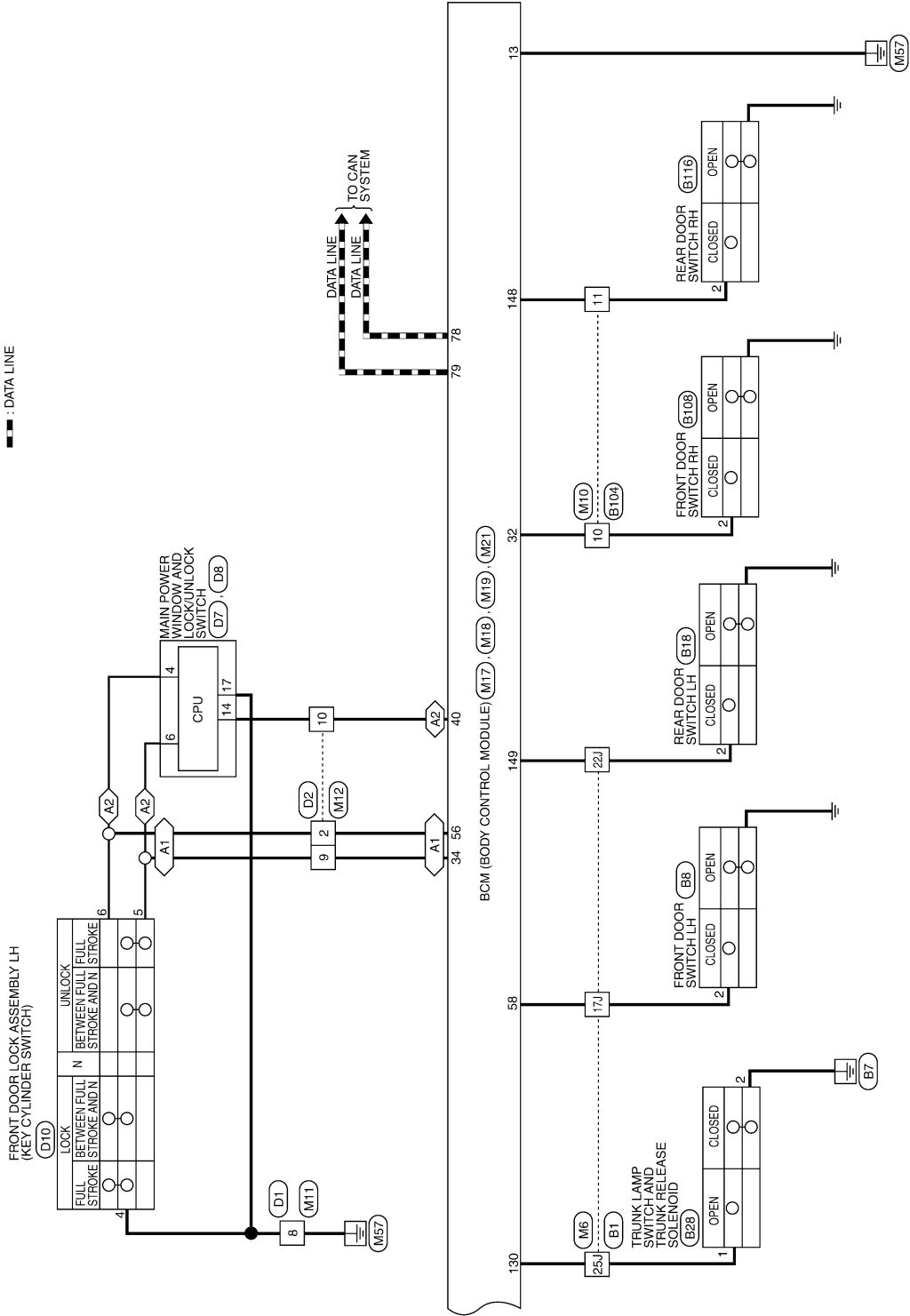

AWJWA0046G1

# INTERIOR ROOM LAMP CONTROL SYSTEM

## < COMPONENT DIAGNOSIS >

### INTERIOR ROOM LAMP CONNECTORS

Connector No.	M1
Connector Name	WIRE TO WIRE
Connector Color	WHITE

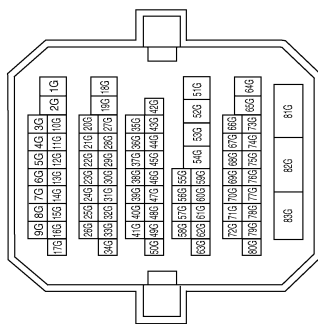

Terminal No.	82G	Color of Wire	W/B	Signal Name	—
--------------	-----	---------------	-----	-------------	---

Connector No.	M3
Connector Name	FUSE BLOCK (J/B)
Connector Color	WHITE

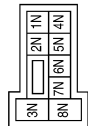

Terminal No.	Color of Wire	Signal Name
4N	G/Y	—
7N	Y/R	—

Connector No.	M6
Connector Name	WIRE TO WIRE
Connector Color	WHITE

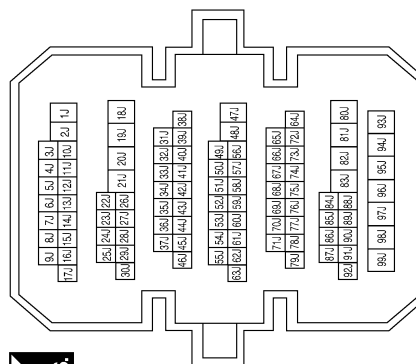

Terminal No.	17J	Color of Wire	SB	Signal Name	—
	22J	R/B	—	—	—
	23J	P/W	—	—	—
	25J	Y/G	—	—	—
	26J	V/W	—	—	—

Connector No.	M7
Connector Name	WIRE TO WIRE
Connector Color	WHITE

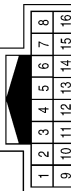

Terminal No.	8	Color of Wire	P/W	Signal Name	—
	9	B	—	—	—
	10	Y	—	—	—
	11	P/W	—	—	—
	15	B	—	—	—

AWJIA0126GB

A  
B  
C  
D  
E  
F  
G  
H  
I  
J  
K  
L  
M  
N  
O  
P



# INTERIOR ROOM LAMP CONTROL SYSTEM

## < COMPONENT DIAGNOSIS >

Connector No.	M12
Connector Name	WIRE TO WIRE
Connector Color	WHITE

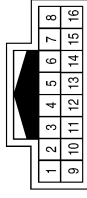

Terminal No.	Color of Wire	Signal Name
2	L/B	—
4	P/W	—
9	L/R	—
10	Y/G	—
13	R/W	—

Connector No.	M11
Connector Name	WIRE TO WIRE
Connector Color	WHITE

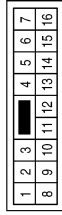

Terminal No.	Color of Wire	Signal Name
8	B	—

Connector No.	M10
Connector Name	WIRE TO WIRE
Connector Color	BROWN

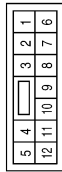

Terminal No.	Color of Wire	Signal Name
10	R/B	—
11	R/W	—

Connector No.	M17
Connector Name	BCM (BODY CONTROL MODULE)
Connector Color	WHITE



Terminal No.	Color of Wire	Signal Name
4	P/W	ROOM_LAMP_BAT_SAVER
7	R/W	STEP_LAMP_OUTPUT
11	Y/R	BAT_BCM_FUSE
13	B	GND1
19	Y	ROOM_LAMP_OUTPUT

Connector No.	M16
Connector Name	BCM (BODY CONTROL MODULE)
Connector Color	BLACK



Terminal No.	Color of Wire	Signal Name
1	W/B	BAT_POWER_F/L

Connector No.	M15
Connector Name	WIRE TO WIRE
Connector Color	WHITE

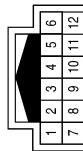

Terminal No.	Color of Wire	Signal Name
6	P/W	—
11	R/W	—

ALJIA0039GB



# INTERIOR ROOM LAMP CONTROL SYSTEM

## < COMPONENT DIAGNOSIS >

Connector No.	M20
Connector Name	BCM (BODY CONTROL MODULE)
Connector Color	WHITE

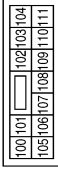

Terminal No.	Color of Wire	V/W	Signal Name
110			TRUNK_LAMP_ OUTPUT

Connector No.	M19
Connector Name	BCM (BODY CONTROL MODULE)
Connector Color	BLACK



79	78	77	76	75	74	73	72	71	70	69	68	67	66	65	64	63	62	61	60
99	98	97	96	95	94	93	92	91	90	89	88	87	86	85	84	83	82	81	80

Terminal No.	Color of Wire	Signal Name
78	P	CAN-L
79	L	CAN-H
80	R/L	FOB_SLOT_ ILLUMINATION

Connector No.	M18
Connector Name	BCM (BODY CONTROL MODULE)
Connector Color	GREEN



59	58	57	56	55	54	53	52	51	50	49	48	47	46	45	44	43	42	41	40
39	38	37	36	35	34	33	32	31	30	29	28	27	26	25	24	23	22	21	20

Terminal No.	Color of Wire	Signal Name
32	R/B	AS_DOOR_SW
34	L/R	DOOR_KEY/C UNLOCK_SW
40	Y/G	PW_K-LINE
56	L/B	DOOR_KEY/C_ LOCK_SW
58	SB	DR_DOOR_SW

Connector No.	M63
Connector Name	JOINT CONNECTOR-M02
Connector Color	BLUE



Terminal No.	Color of Wire	Signal Name
1	B	—
8	B	—

Connector No.	M40
Connector Name	KEY SLOT
Connector Color	WHITE



Terminal No.	Color of Wire	Signal Name
5	G/Y	LIGHT_BAT+
6	R/L	LIGHT_A
7	B	GND

Connector No.	M21
Connector Name	BCM (BODY CONTROL MODULE)
Connector Color	GRAY



131	130	129	128	127	126	125	124	123	122	121	120	119	118	117	116	115	114	113	112
151	150	149	148	147	146	145	144	143	142	141	140	139	138	137	136	135	134	133	132

Terminal No.	Color of Wire	Signal Name
130	Y/G	TRUNK_SW
148	R/W	RR_DOOR_SW
149	R/B	RL_DOOR_SW

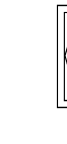
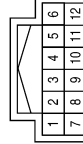

ALJIA0040GB

# INTERIOR ROOM LAMP CONTROL SYSTEM

## < COMPONENT DIAGNOSIS >

Terminal No.	Color of Wire	Signal Name
17J	SB	—
22J	R/B	—
23J	P	—
25J	Y/G	—
26J	V/W	—

Connector No.	B1
Connector Name	WIRE TO WIRE
Connector Color	WHITE

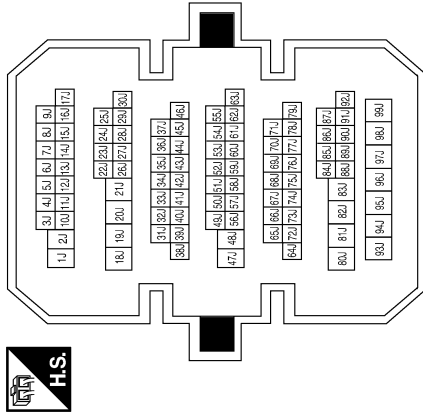

Connector No.	E30
Connector Name	WIRE TO WIRE
Connector Color	WHITE

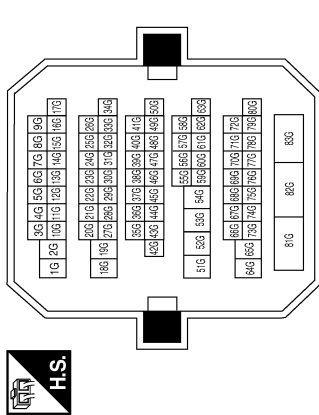

Terminal No.	Color of Wire	Signal Name
82G	W/B	—

Connector No.	B28
Connector Name	TRUNK LAMP SWITCH AND TRUNK RELEASE SOLENOID
Connector Color	WHITE



Connector No.	B18
Connector Name	REAR DOOR SWITCH LH
Connector Color	WHITE



Connector No.	B8
Connector Name	FRONT DOOR SWITCH LH
Connector Color	WHITE



Terminal No.	Color of Wire	Signal Name
1	Y/G	—
2	B	—

Terminal No.	Color of Wire	Signal Name
2	R/B	DOOR SW(RL)

Terminal No.	Color of Wire	Signal Name
2	SB	DOOR SW(DR)

ALJIA0041GB

# INTERIOR ROOM LAMP CONTROL SYSTEM

## < COMPONENT DIAGNOSIS >

Connector No.	B108
Connector Name	FRONT DOOR SWITCH RH
Connector Color	WHITE

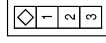

Terminal No.	Color of Wire	Signal Name
2	R/B	DOOR SW (AS)

Connector No.	B104
Connector Name	WIRE TO WIRE
Connector Color	BROWN

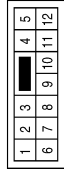

Terminal No.	Color of Wire	Signal Name
10	R/B	—
11	R/W	—

Connector No.	B36
Connector Name	TRUNK ROOM LAMP
Connector Color	WHITE



Terminal No.	Color of Wire	Signal Name
1	P	—
2	V/W	—

Connector No.	R3
Connector Name	VANITY MIRROR LAMP LH
Connector Color	WHITE



Terminal No.	Color of Wire	Signal Name
1	B	GND
2	P	ROOM_LAMP_BAT_SAVER

Connector No.	R1
Connector Name	WIRE TO WIRE
Connector Color	WHITE

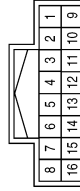

Terminal No.	Color of Wire	Signal Name
8	P	—
9	W	—
10	W	—
11	W	—
15	B	—

Connector No.	B116
Connector Name	REAR DOOR SWITCH RH
Connector Color	WHITE

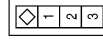

Terminal No.	Color of Wire	Signal Name
2	R/W	DOOR SW (RR)

ALJIA0042GB

# INTERIOR ROOM LAMP CONTROL SYSTEM

## < COMPONENT DIAGNOSIS >

Connector No.	R9
Connector Name	VANITY MIRROR LAMP RH
Connector Color	WHITE



Terminal No.	Color of Wire	Signal Name
1	B	GND
2	P	ROOM_LAMP_BAT_SAVER

Connector No.	R50
Connector Name	FRONT ROOM/MAP LAMP ASSEMBLY
Connector Color	GRAY

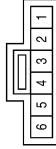

Terminal No.	Color of Wire	Signal Name
1	W	—
2	W	—
3	W	—

Connector No.	D1
Connector Name	WIRE TO WIRE
Connector Color	WHITE

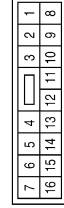

Terminal No.	Color of Wire	Signal Name
8	B	—

Connector No.	D2
Connector Name	WIRE TO WIRE
Connector Color	WHITE

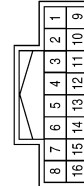

Terminal No.	Color of Wire	Signal Name
2	L/B	—
4	P/W	—
9	L/R	—
10	Y/G	—
13	R/W	—

Connector No.	D7 (WITH LEFT AND RIGHT FRONT POWER WINDOW ANTI-PINCH SYSTEM)
Connector Name	MAIN POWER WINDOW AND LOCK/UNLOCK SWITCH
Connector Color	WHITE

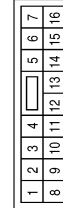

Terminal No.	Color of Wire	Signal Name
4	L/B	LOCK
6	L/R	UNLOCK
14	Y/G	COM

Connector No.	D7 (WITH LEFT FRONT ONLY POWER WINDOW ANTI-PINCH SYSTEM)
Connector Name	MAIN POWER WINDOW AND LOCK/UNLOCK SWITCH
Connector Color	WHITE

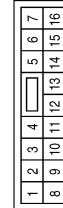

Terminal No.	Color of Wire	Signal Name
6	GR/R	UNLOCK

# INTERIOR ROOM LAMP CONTROL SYSTEM

## < COMPONENT DIAGNOSIS >

Connector No.	D11
Connector Name	STEP LAMP LH
Connector Color	WHITE



Terminal No.	Color of Wire	Signal Name
1	P/W	—
2	R/W	—

Connector No.	D10
Connector Name	FRONT DOOR LOCK ASSEMBLY LH
Connector Color	GRAY

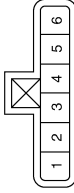

Terminal No.	Color of Wire	Signal Name
4	B	GND
5	L/R	DOOR_KEY/C_ UNLOCK_SW
6	L/B	DOOR_KEY/C_ LOCK_SW

Connector No.	D8
Connector Name	MAIN POWER WINDOW AND LOCK/UNLOCK SWITCH
Connector Color	WHITE

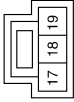

Terminal No.	Color of Wire	Signal Name
17	B	GND

Connector No.	D109
Connector Name	STEP LAMP RH
Connector Color	WHITE



Terminal No.	Color of Wire	Signal Name
1	P/W	—
2	R/W	—

Connector No.	D102
Connector Name	WIRE TO WIRE
Connector Color	WHITE

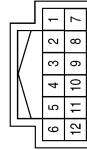

Terminal No.	Color of Wire	Signal Name
6	P/W	—
11	R/W	—

AWJIA0128GB

A  
B  
C  
D  
E  
F  
G  
H  
I  
J  
K  
INL  
M  
N  
O  
P

# INTERIOR ROOM LAMP CONTROL SYSTEM

## < COMPONENT DIAGNOSIS >

Connector No.	D7 (WITH LEFT FRONT ONLY POWER WINDOW ANTI-PINCH SYSTEM)
Connector Name	MAIN POWER WINDOW AND LOCK/UNLOCK SWITCH
Connector Color	WHITE

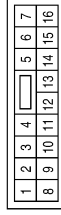

Terminal No.	Color of Wire	Signal Name
6	GR/R	UNLOCK

Connector No.	D7 (WITH LEFT AND RIGHT FRONT POWER WINDOW ANTI-PINCH SYSTEM)
Connector Name	MAIN POWER WINDOW AND LOCK/UNLOCK SWITCH
Connector Color	WHITE

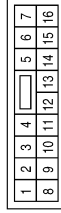

Terminal No.	Color of Wire	Signal Name
4	L/B	LOCK
6	L/R	UNLOCK
14	Y/G	COM

Connector No.	D2
Connector Name	WIRE TO WIRE
Connector Color	WHITE

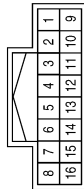

Terminal No.	Color of Wire	Signal Name
2	L/B	—
4	P/W	—
9	L/R	—
10	Y/G	—
13	R/W	—

Connector No.	D11
Connector Name	STEP LAMP LH
Connector Color	WHITE



Terminal No.	Color of Wire	Signal Name
1	P/W	—
2	R/W	—

Connector No.	D10
Connector Name	FRONT DOOR LOCK ASSEMBLY LH
Connector Color	GRAY

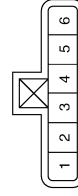

Terminal No.	Color of Wire	Signal Name
4	B	GND
5	L/R	DOOR_KEY/C_ UNLOCK_SW
6	L/B	DOOR_KEY/C_ LOCK_SW

Connector No.	D8
Connector Name	MAIN POWER WINDOW AND LOCK/UNLOCK SWITCH
Connector Color	WHITE

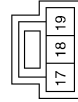

Terminal No.	Color of Wire	Signal Name
17	B	GND

# INTERIOR ROOM LAMP CONTROL SYSTEM

## < COMPONENT DIAGNOSIS >

Connector No.	D109
Connector Name	STEP LAMP RH
Connector Color	WHITE



Terminal No.	Color of Wire	Signal Name
1	P/W	—
2	R/W	—

Connector No.	D102
Connector Name	WIRE TO WIRE
Connector Color	WHITE

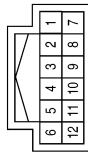

Terminal No.	Color of Wire	Signal Name
6	P/W	—
11	R/W	—

A  
B  
C  
D  
E  
F  
G  
H  
I  
J  
K  
INL  
M  
N  
O  
P

ALJIA0046GB

# ILLUMINATION

< COMPONENT DIAGNOSIS >

## ILLUMINATION

### Wiring Diagram - Coupe

INFOID:000000001830338

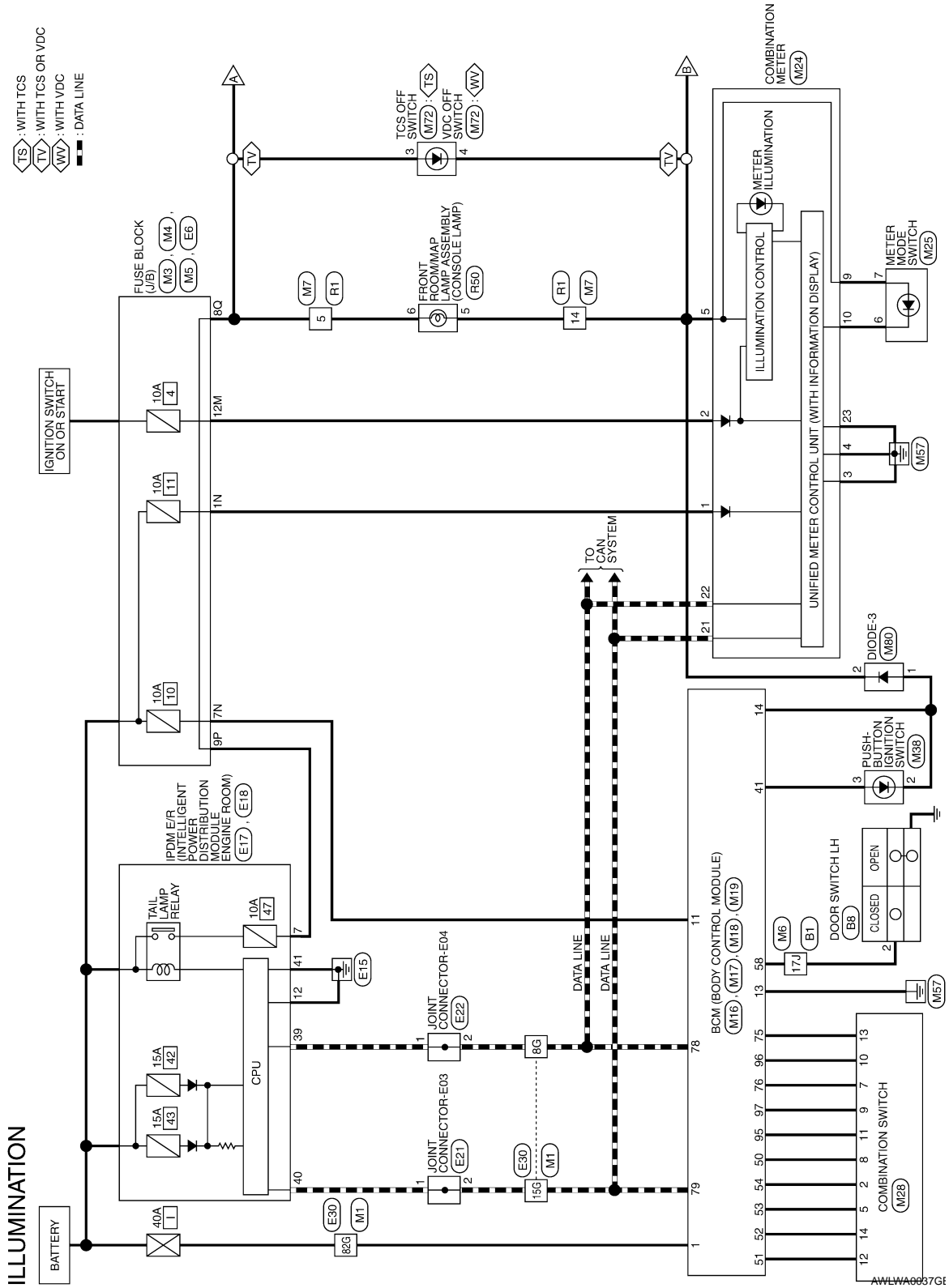



# ILLUMINATION

## < COMPONENT DIAGNOSIS >

- ◊EN◊ : WITHOUT NAVI
- ◊HS◊ : WITH HEATED SEATS
- ◊NV◊ : WITH NAVI
- ◊PM◊ : WITH POWER OUTSIDE MIRRORS

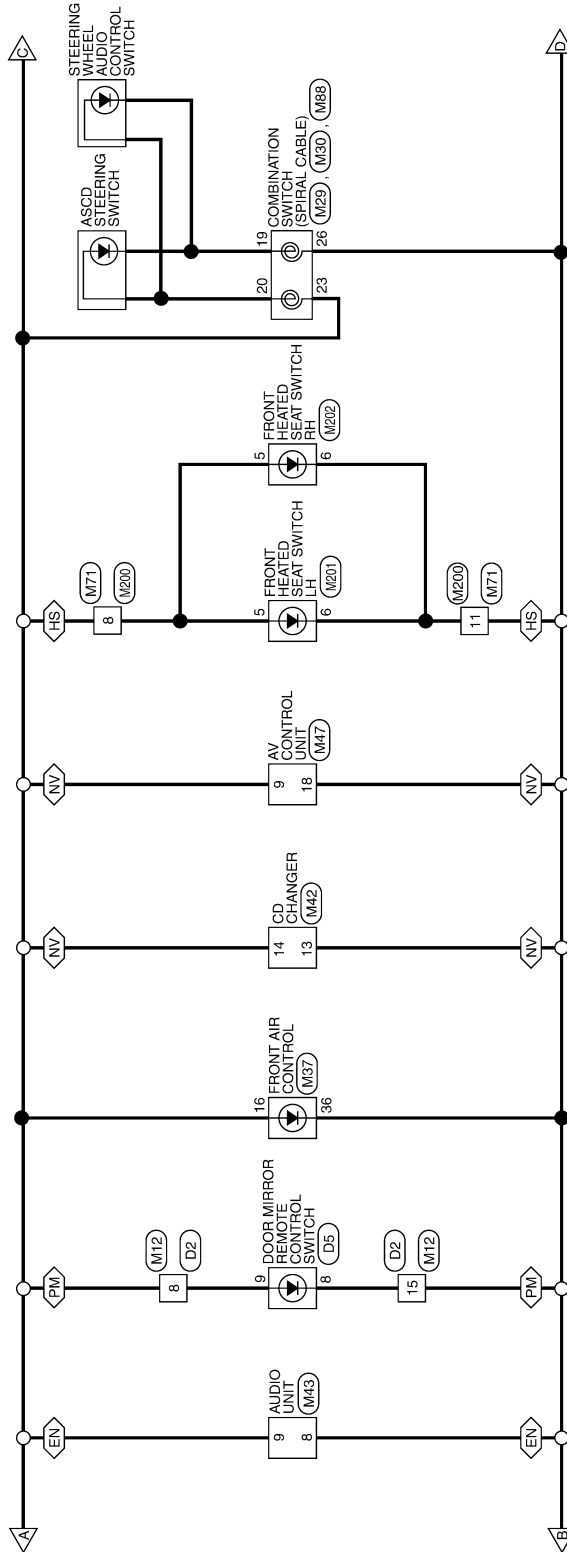

A  
B  
C  
D  
E  
F  
G  
H  
I  
J  
K  
L  
M  
N  
O  
P

INL

ALJWA0007GB

# ILLUMINATION

< COMPONENT DIAGNOSIS >

VT WITH CVT

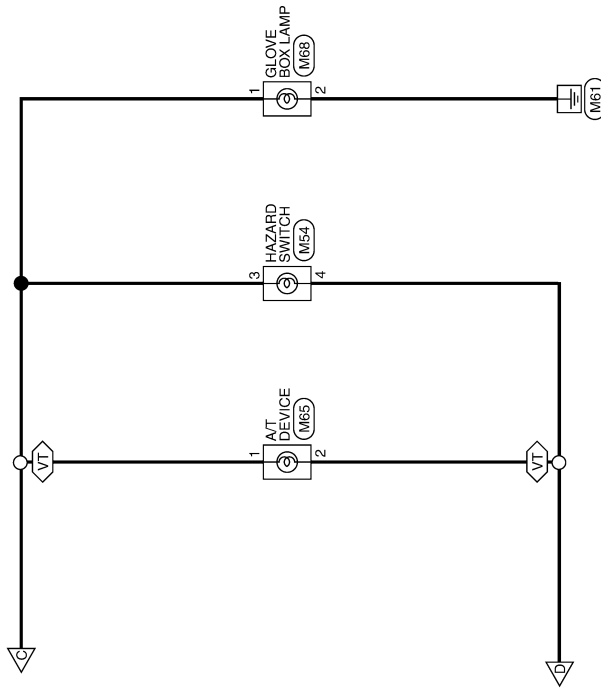

ALJWA0008GB

## ILLUMINATION CONNECTORS

Connector No.	M1
Connector Name	WIRE TO WIRE
Connector Color	WHITE

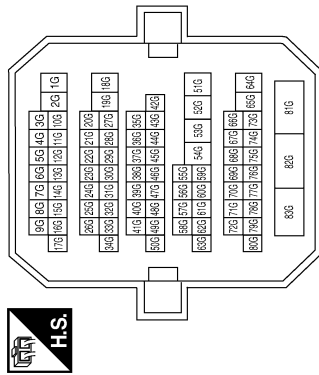

Terminal No.	Color of Wire	Signal Name
8G	P	—
15G	L	—
82G	W/B	—

Connector No.	M3
Connector Name	FUSE BLOCK (J/B)
Connector Color	WHITE

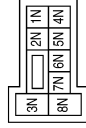

Terminal No.	Color of Wire	Signal Name
1N	W/L	—
7N	Y/R	—

Connector No.	M4
Connector Name	FUSE BLOCK (J/B)
Connector Color	WHITE

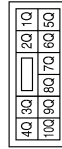

Connector No.	M5
Connector Name	FUSE BLOCK (J/B)
Connector Color	WHITE

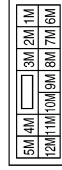

Terminal No.	Color of Wire	Signal Name
8Q	R/L	—

Terminal No.	Color of Wire	Signal Name
12M	P	—

A  
B  
C  
D  
E  
F  
G  
H  
I  
J  
K  
L  
M  
N  
O  
P

**INL**

# ILLUMINATION

## < COMPONENT DIAGNOSIS >

Connector No.	M7
Connector Name	WIRE TO WIRE
Connector Color	WHITE

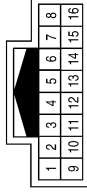

Terminal No.	Color of Wire	Signal Name
5	R/L	—
14	R/Y	—

Terminal No.	17J	Color of Wire	SB	Signal Name	—
--------------	-----	---------------	----	-------------	---

Connector No.	M6
Connector Name	WIRE TO WIRE
Connector Color	WHITE

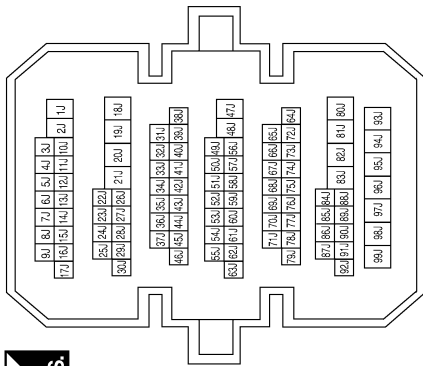

Connector No.	M17
Connector Name	BCM (BODY CONTROL MODULE)
Connector Color	WHITE

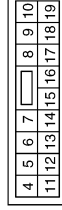

Terminal No.	11	Y/R	BAT BCM FUSE
	13	B	GND1
	14	R/Y	LOW_SIDE_PUSH_LE D_OUTPUT

Connector No.	M16
Connector Name	BCM (BODY CONTROL MODULE)
Connector Color	BLACK



Terminal No.	1	Color of Wire	W/B	Signal Name	BAT_POWER_F/L
--------------	---	---------------	-----	-------------	---------------

Connector No.	M12
Connector Name	WIRE TO WIRE
Connector Color	WHITE

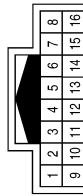

Terminal No.	8	Color of Wire	R/L	Signal Name	—
	15	R/Y	—	—	—

AWLIA0182GB

Connector No.	M24
Connector Name	COMBINATION METER
Connector Color	WHITE

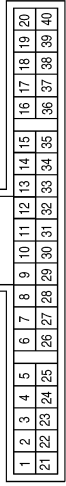

Terminal No.	Color of Wire	Signal Name
1	W/L	BATT
2	O	IGN
3	B	GND
4	B	GND
5	R/Y	ILL OUTPUT
9	GR/W	SW ILL PWR
10	O/L	GND(SATTLITE SW)
21	L	CAN-H
22	P	CAN-L
23	B	GND

Connector No.	M19
Connector Name	BCM (BODY CONTROL MODULE)
Connector Color	BLACK

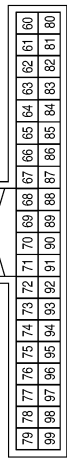
Terminal No.	Color of Wire	Signal Name
75	R/Y	OUTPUT_5
76	R/G	OUTPUT_3
78	P	CAN-L
79	L	CAN-H
95	R/W	OUTPUT_1
96	P/B	OUTPUT_4
97	R/B	OUTPUT_2

Connector No.	M18
Connector Name	BCM (BODY CONTROL MODULE)
Connector Color	GREEN

Terminal No.	Color of Wire	Signal Name
41	W	PUSH_LED
50	LG/B	INPUT_5
51	L/W	INPUT_1
52	G/B	INPUT_2
53	LG/R	INPUT_3
54	G/Y	INPUT_4
58	SB	DR_DOOR_SW

Terminal No.	Color of Wire	Signal Name
2	G/Y	OUTPUT_4
5	LG/R	OUTPUT_3
7	R/G	INPUT_3
8	LG/B	OUTPUT_5
9	R/B	INPUT_2
10	P/B	INPUT_4
11	R/W	INPUT_1
12	L/W	OUTPUT_1
13	R/Y	INPUT_5
14	G/B	OUTPUT_2

Connector No.	M28
Connector Name	COMBINATION SWITCH
Connector Color	WHITE

Connector No.	M25
Connector Name	METER MODE SWITCH
Connector Color	BLACK

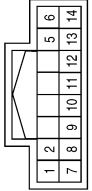
Terminal No.	Color of Wire	Signal Name
6	O/L	GND(SATTLITE SW)
7	GR/W	SW ILL PWR

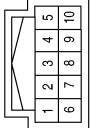
AWLIA0183GB

A  
B  
C  
D  
E  
F  
G  
H  
I  
J  
K  
L  
M  
N  
O  
P



# ILLUMINATION

## < COMPONENT DIAGNOSIS >

Connector No.	M37
Connector Name	FRONT AIR CONTROL
Connector Color	WHITE

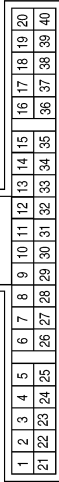

Terminal No.	Color of Wire	Signal Name
16	R/L	ILL +
36	R/Y	ILL-

Connector No.	M30
Connector Name	COMBINATION SWITCH (SPIRAL CABLE)
Connector Color	GRAY

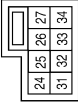
Terminal No.	Color of Wire	Signal Name
26	R/Y	ILL CONT OUT

Connector No.	M29
Connector Name	COMBINATION SWITCH (SPIRAL CABLE)
Connector Color	YELLOW

Terminal No.	Color of Wire	Signal Name
23	R/L	TAIL/ILL RLY

Connector No.	M43
Connector Name	AUDIO UNIT
Connector Color	WHITE



Terminal No.	Color of Wire	Signal Name
8	R/Y	ILL CONT OUT
9	R/L	TAIL/ILL RLY

Connector No.	M42
Connector Name	CD CHANGER
Connector Color	WHITE



Terminal No.	Color of Wire	Signal Name
13	R/Y	ILL -
14	R/L	ILL +

Connector No.	M38
Connector Name	PUSH-BUTTON IGNITION SWITCH
Connector Color	BROWN



Terminal No.	Color of Wire	Signal Name
2	O/W	—
3	W	PUSH_LED

AWLIA0184GB

# ILLUMINATION

## < COMPONENT DIAGNOSIS >

Connector No.	M65
Connector Name	A/T DEVICE
Connector Color	BROWN



Terminal No.	Color of Wire	Signal Name
1	R/L	TAIL/ILL_RLY
2	R/Y	ILL_CONT_OUT

Connector No.	M54
Connector Name	HAZARD SWITCH
Connector Color	WHITE

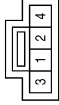

Terminal No.	Color of Wire	Signal Name
3	R/L	TAIL/ILL_RLY
4	R/Y	ILL_CONT_OUT

Connector No.	M47
Connector Name	AV CONTROL UNIT
Connector Color	WHITE

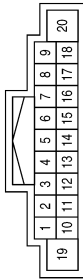

Terminal No.	Color of Wire	Signal Name
9	R/L	ILL
18	R/Y	ILL_CONT

Connector No.	M202
Connector Name	FRONT HEATED SEAT SWITCH RH
Connector Color	BROWN



Terminal No.	Color of Wire	Signal Name
5	R/L	TAIL/ILL_RLY
6	R/Y	ILL_CONT_OUT

Connector No.	M71
Connector Name	WIRE TO WIRE
Connector Color	WHITE

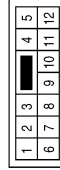

Terminal No.	Color of Wire	Signal Name
8	R/L	—
11	R/Y	—

Connector No.	M68
Connector Name	GLOVE BOX LAMP
Connector Color	WHITE



Terminal No.	Color of Wire	Signal Name
1	R/L	TAIL/ILL_RLY
2	B	GND

AWLIA0185GB

# ILLUMINATION

## < COMPONENT DIAGNOSIS >

Connector No.	M80
Connector Name	DIODE-3
Connector Color	—



Terminal No.	Color of Wire	Signal Name
1	O/W	LOW_SIDE_PUSH_LE D_OUTPUT
2	R/Y	ILL_CONT_OUT

Connector No.	M72
Connector Name	VDC OFF SWITCH (WITH VDC)
Connector Color	GRAY

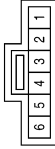

Terminal No.	Color of Wire	Signal Name
3	R/L	TAIL/ILL_RLY
4	R/Y	ILL_CONT_OUT

Connector No.	M72
Connector Name	TCS OFF SWITCH (WITH TCS)
Connector Color	GRAY

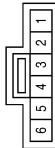

Terminal No.	Color of Wire	Signal Name
3	R/L	TAIL/ILL_RLY
4	R/Y	ILL_CONT_OUT

Connector No.	M201
Connector Name	FRONT HEATED SEAT SWITCH LH
Connector Color	WHITE



Terminal No.	Color of Wire	Signal Name
5	R/L	TAIL/ILL_RLY
6	R/Y	ILL_CONT_OUT

Connector No.	M200
Connector Name	WIRE TO WIRE
Connector Color	WHITE

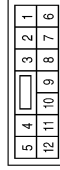

Terminal No.	Color of Wire	Signal Name
8	R/L	—
11	R/Y	—

Connector No.	M88
Connector Name	COMBINATION SWITCH (SPIRAL CABLE)
Connector Color	GRAY



Terminal No.	Color of Wire	Signal Name
19	P	ILL
20	Y	ILL

ALJIA0052GB



# ILLUMINATION

## < COMPONENT DIAGNOSIS >

Connector No.	E6
Connector Name	FUSE BLOCK (J/B)
Connector Color	WHITE



Terminal No.	Color of Wire	Signal Name
9P	R/L	—

Connector No.	E17
Connector Name	IPDM E/R (INTELLIGENT POWER DISTRIBUTION MODULE ENGINE ROOM)
Connector Color	WHITE

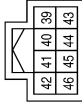

Terminal No.	Color of Wire	Signal Name
39	P	CAN-L
40	L	CAN-H
41	B	S-GND

Connector No.	E18
Connector Name	IPDM E/R (INTELLIGENT POWER DISTRIBUTION MODULE ENGINE ROOM)
Connector Color	WHITE

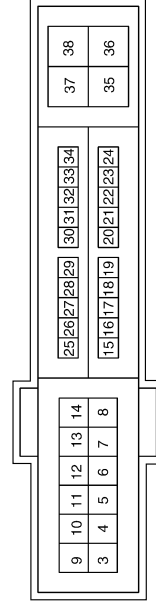

Terminal No.	Color of Wire	Signal Name
7	R/L	TAIL/ILLUMI
12	B	P-GND

Connector No.	E21
Connector Name	JOINT CONNECTOR-E03
Connector Color	WHITE

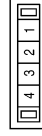

Terminal No.	Color of Wire	Signal Name
1	L	—
2	L	—

AWLIA0186GB

# ILLUMINATION

## < COMPONENT DIAGNOSIS >

Connector No.	E22
Connector Name	JOINT CONNECTOR-E04
Connector Color	WHITE

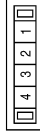

Terminal No.	Color of Wire	Signal Name
1	P	—
2	P	—

Connector No.	E30
Connector Name	WIRE TO WIRE
Connector Color	WHITE

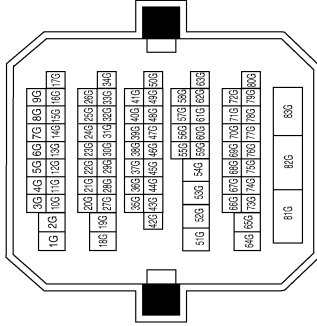

Terminal No.	Color of Wire	Signal Name
8G	P	—
15G	L	—
82G	W/B	—

Connector No.	B1
Connector Name	WIRE TO WIRE
Connector Color	WHITE

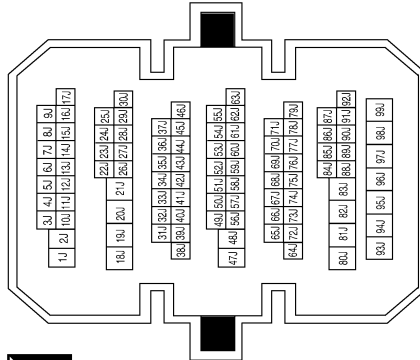

Terminal No.	Color of Wire	Signal Name
17J	SB	—

Connector No.	B8
Connector Name	DOOR SWITCH LH
Connector Color	WHITE

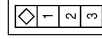

Terminal No.	Color of Wire	Signal Name
2	SB	DOOR SW (DR)

# ILLUMINATION

## < COMPONENT DIAGNOSIS >

Connector No.	D2
Connector Name	WIRE TO WIRE
Connector Color	WHITE

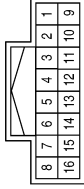

Terminal No.	Color of Wire	Signal Name
8	R/L	—
15	R/Y	—

Connector No.	R50
Connector Name	FRONT ROOM/MAP LAMP ASSEMBLY
Connector Color	GRAY

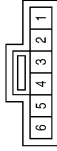

Terminal No.	Color of Wire	Signal Name
5	Y	—
6	L	—

Connector No.	R1
Connector Name	WIRE TO WIRE
Connector Color	WHITE

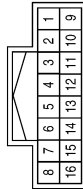

Terminal No.	Color of Wire	Signal Name
5	L	—
14	Y	—

Connector No.	D5
Connector Name	DOOR MIRROR REMOTE CONTROL SWITCH
Connector Color	WHITE

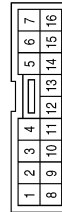

Terminal No.	Color of Wire	Signal Name
8	R/Y	ILL_CONT_OUT
9	R/L	TAIL/ILL_RLY

AWLIA0188GB

A  
B  
C  
D  
E  
F  
G  
H  
I  
J  
K  
INL  
M  
N  
O  
P

# ILLUMINATION

## < COMPONENT DIAGNOSIS >

Connector No.	D5
Connector Name	DOOR MIRROR REMOTE CONTROL SWITCH
Connector Color	WHITE

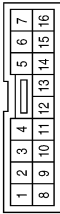

Terminal No.	Color of Wire	Signal Name
8	R/Y	ILL_CONT_OUT
9	R/L	TAIL/ILL_RLY

ALJIA0056GB

# ILLUMINATION

< COMPONENT DIAGNOSIS >

## Wiring Diagram - Sedan

INFOID:000000003219634

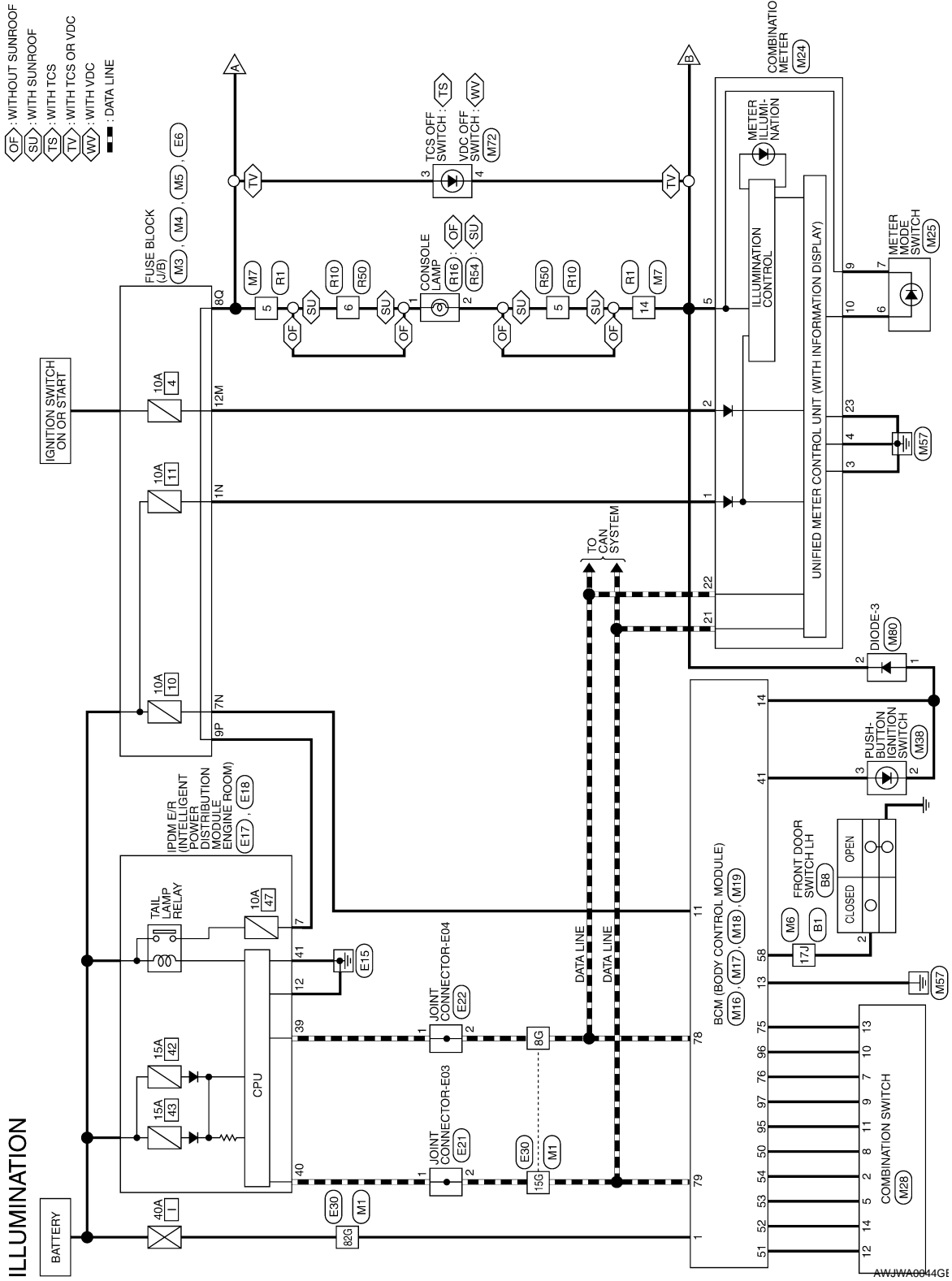

A  
B  
C  
D  
E  
F  
G  
H  
I  
J  
K  
L  
M  
N  
O  
P



# ILLUMINATION

< COMPONENT DIAGNOSIS >

- ◊EN◊ : WITHOUT NAVI
- ◊HS◊ : WITH HEATED SEATS
- ◊NV◊ : WITH NAVI
- ◊PM◊ : WITH POWER OUTSIDE MIRRORS

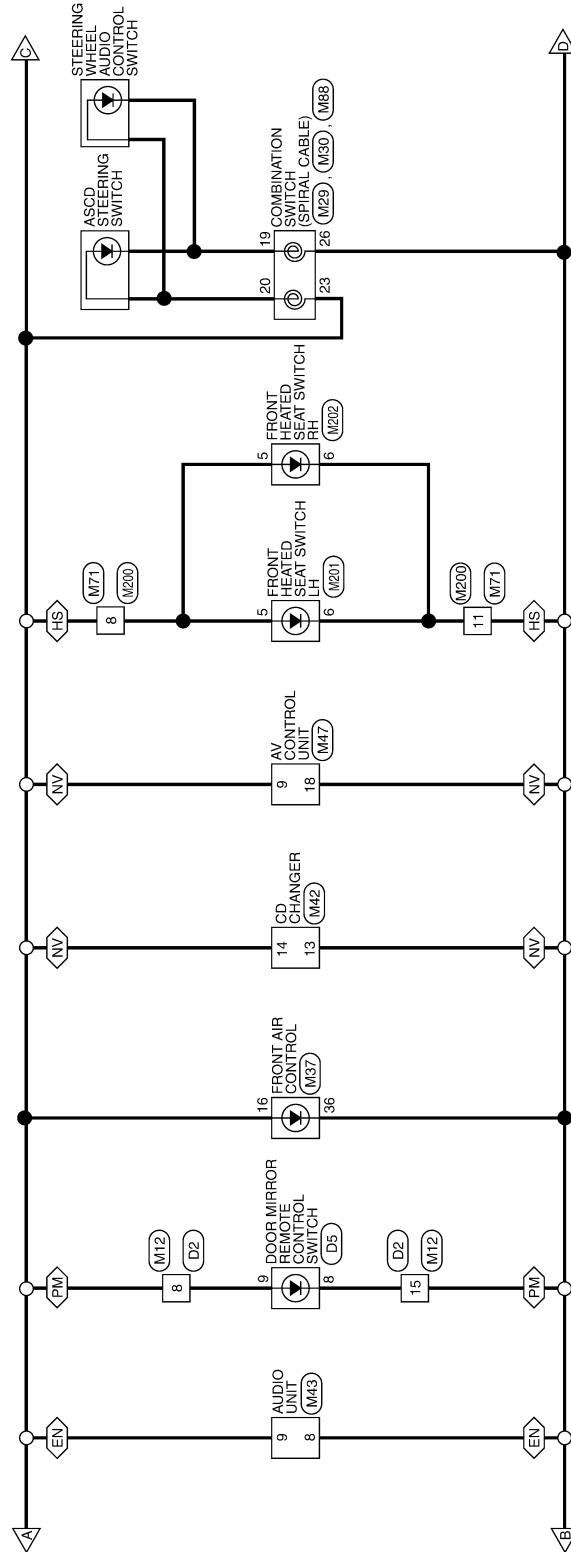

ALJWA0007GB

# ILLUMINATION

< COMPONENT DIAGNOSIS >

VT WITH CVT

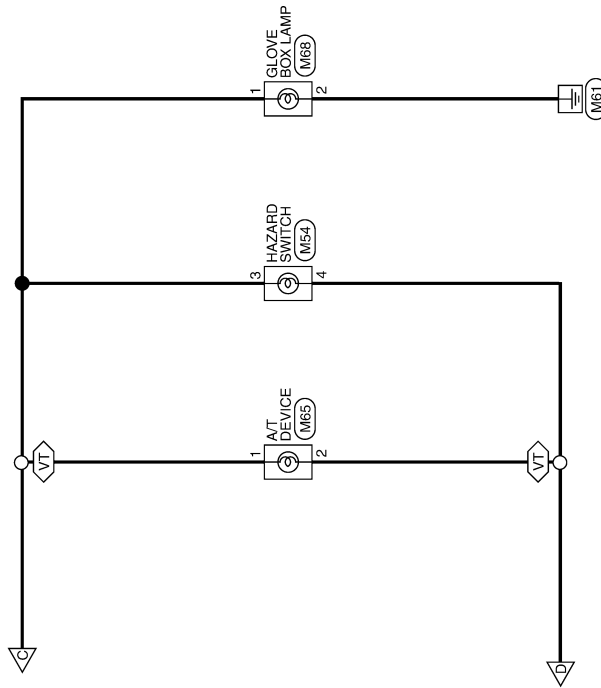

A

B

C

D

E

F

G

H

I

J

K

INL

M

N

O

P

ALJWA0008GB

## ILLUMINATION CONNECTORS

Connector No.	M1
Connector Name	WIRE TO WIRE
Connector Color	WHITE

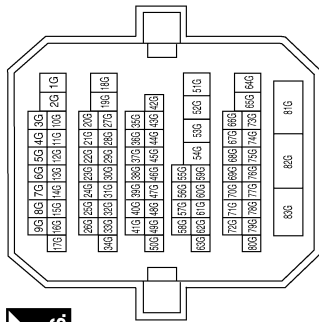

Terminal No.	Color of Wire	Signal Name
8G	P	—
15G	L	—
82G	W/B	—

Connector No.	M3
Connector Name	FUSE BLOCK (J/B)
Connector Color	WHITE

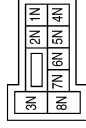

Terminal No.	Color of Wire	Signal Name
1N	W/L	—
7N	Y/R	—

Connector No.	M4
Connector Name	FUSE BLOCK (J/B)
Connector Color	WHITE

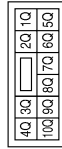

Terminal No.	Color of Wire	Signal Name
8Q	R/L	—

Connector No.	M5
Connector Name	FUSE BLOCK (J/B)
Connector Color	WHITE

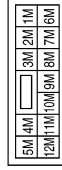

Terminal No.	Color of Wire	Signal Name
12M	P	—



# ILLUMINATION

< COMPONENT DIAGNOSIS >

Connector No.	M7
Connector Name	WIRE TO WIRE
Connector Color	WHITE

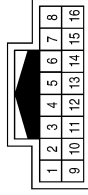

Terminal No.	Color of Wire	Signal Name
5	R/L	—
14	R/Y	—

Terminal No.	17J	Color of Wire	SB	Signal Name	—
--------------	-----	---------------	----	-------------	---

Connector No.	M6
Connector Name	WIRE TO WIRE
Connector Color	WHITE

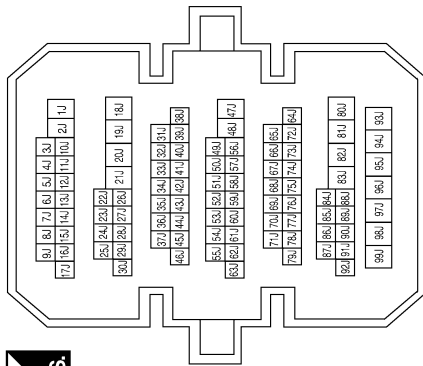

Connector No.	M17
Connector Name	BCM (BODY CONTROL MODULE)
Connector Color	WHITE



Terminal No.	11	Y/R	BAT_BCM_FUSE
	13	B	GND1
	14	R/Y	LOW_SIDE_PUSH_LE D_OUTPUT

Connector No.	M16
Connector Name	BCM (BODY CONTROL MODULE)
Connector Color	BLACK



Terminal No.	1	Color of Wire	W/B	Signal Name	BAT_POWER_F/L
--------------	---	---------------	-----	-------------	---------------

Connector No.	M12
Connector Name	WIRE TO WIRE
Connector Color	WHITE

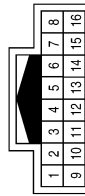

Terminal No.	8	Color of Wire	R/L	Signal Name	—
	15	R/Y	—	—	—

AWJIA0121GB

A  
B  
C  
D  
E  
F  
G  
H  
I  
J  
K  
L  
M  
N  
O  
P

INL

# ILLUMINATION

< COMPONENT DIAGNOSIS >

Connector No.	M24
Connector Name	COMBINATION METER
Connector Color	WHITE

1	2	3	4	5	6	7	8	9	10	11	12	13	14	15	16	17	18	19	20
21	22	23	24	25	26	27	28	29	30	31	32	33	34	35	36	37	38	39	40

Terminal No.	Color of Wire	Signal Name
1	W/L	BATT
2	O	IGN
3	B	GND
4	B	GND
5	R/Y	ILL OUTPUT
9	GR/W	SW ILL PWR
10	O/L	GND(SATLLITE SW)
21	L	CAN-H
22	P	CAN-L
23	B	GND

Connector No.	M19
Connector Name	BCM (BODY CONTROL MODULE)
Connector Color	BLACK

79	78	77	76	75	74	73	72	71	70	69	68	67	66	65	64	63	62	61	60
59	58	57	56	55	54	53	52	51	50	49	48	47	46	45	44	43	42	41	40

Terminal No.	Color of Wire	Signal Name
75	R/Y	OUTPUT_5
76	R/G	OUTPUT_3
78	P	CAN-L
79	L	CAN-H
95	R/W	OUTPUT_1
96	P/B	OUTPUT_4
97	R/B	OUTPUT_2

Connector No.	M18
Connector Name	BCM (BODY CONTROL MODULE)
Connector Color	GREEN

  

39	38	37	36	35	34	33	32	31	30	29	28	27	26	25	24	23	22	21	20
59	58	57	56	55	54	53	52	51	50	49	48	47	46	45	44	43	42	41	40

Terminal No.	Color of Wire	Signal Name
41	W	PUSH_LED
50	LG/B	INPUT_5
51	L/W	INPUT_1
52	G/B	INPUT_2
53	LG/R	INPUT_3
54	G/Y	INPUT_4
58	SB	DR_DOOR_SW

Terminal No.	Color of Wire	Signal Name
2	G/Y	OUTPUT_4
5	LG/R	OUTPUT_3
7	R/G	INPUT_3
8	LG/B	OUTPUT_5
9	R/B	INPUT_2
10	P/B	INPUT_4
11	R/W	INPUT_1
12	L/W	OUTPUT_1
13	R/Y	INPUT_5
14	G/B	OUTPUT_2

Connector No.	M28
Connector Name	COMBINATION SWITCH
Connector Color	WHITE

1	2	3	4	5	6		
7	8	9	10	11	12	13	14

Connector No.	M25
Connector Name	METER MODE SWITCH
Connector Color	BLACK

1	2	3	4	5
6	7	8	9	10

Terminal No.	Color of Wire	Signal Name
6	O/L	GND(SATLLITE SW)
7	GR/W	SW ILL PWR

AWJIA0122GB

# ILLUMINATION

## < COMPONENT DIAGNOSIS >

Connector No.	M37
Connector Name	FRONT AIR CONTROL
Connector Color	WHITE

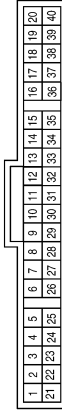

Terminal No.	Color of Wire	Signal Name
16	R/L	ILL +
36	R/Y	ILL-

Connector No.	M30
Connector Name	COMBINATION SWITCH (SPIRAL CABLE)
Connector Color	GRAY

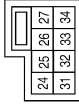

Terminal No.	Color of Wire	Signal Name
26	R/Y	ILL CONT OUT

Connector No.	M29
Connector Name	COMBINATION SWITCH (SPIRAL CABLE)
Connector Color	YELLOW



Terminal No.	Color of Wire	Signal Name
23	R/L	TAIL/ILL_RLY

Connector No.	M43
Connector Name	AUDIO UNIT
Connector Color	WHITE

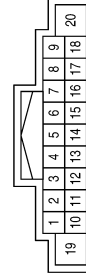

Connector No.	M42
Connector Name	CD CHANGER
Connector Color	WHITE

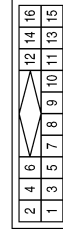

Connector No.	M38
Connector Name	PUSH-BUTTON IGNITION SWITCH
Connector Color	BROWN

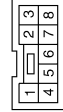

Terminal No.	Color of Wire	Signal Name
13	R/Y	ILL -
14	R/L	ILL +

Terminal No.	Color of Wire	Signal Name
8	R/Y	ILL CONT OUT
9	R/L	TAIL/ILL_RLY

Terminal No.	Color of Wire	Signal Name
2	O/W	—
3	W	PUSH_LED

AWJIA0123GB



# ILLUMINATION

## < COMPONENT DIAGNOSIS >

Connector No.	M65
Connector Name	A/T DEVICE
Connector Color	BROWN



Terminal No.	Color of Wire	Signal Name
1	R/L	TAIL/ILL_RLY
2	R/Y	ILL_CONT_OUT

Connector No.	M54
Connector Name	HAZARD SWITCH
Connector Color	WHITE

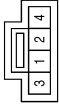

Terminal No.	Color of Wire	Signal Name
3	R/L	TAIL/ILL_RLY
4	R/Y	ILL_CONT_OUT

Connector No.	M47
Connector Name	AV CONTROL UNIT
Connector Color	WHITE

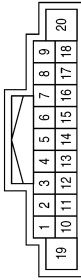

Terminal No.	Color of Wire	Signal Name
9	R/L	ILL
18	R/Y	ILL_CONT

Connector No.	M71
Connector Name	WIRE TO WIRE
Connector Color	WHITE



Terminal No.	Color of Wire	Signal Name
8	R/L	—
11	R/Y	—

Connector No.	M68
Connector Name	GLOVE BOX LAMP
Connector Color	WHITE



Terminal No.	Color of Wire	Signal Name
1	R/L	TAIL/ILL_RLY
2	B	GND

AWJIA0124GB

# ILLUMINATION

## < COMPONENT DIAGNOSIS >

Connector No.	M80
Connector Name	DIODE-3
Connector Color	—



Terminal No.	Color of Wire	Signal Name
1	O/W	LOW_SIDE_PUSH_LE D_OUTPUT
2	R/Y	ILL_CONT_OUT

Connector No.	M72
Connector Name	VDC OFF SWITCH (WITH VDC)
Connector Color	GRAY

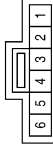

Terminal No.	Color of Wire	Signal Name
3	R/L	TAIL/ILL_RLY
4	R/Y	ILL_CONT_OUT

Connector No.	M72
Connector Name	TCS OFF SWITCH (WITH TCS)
Connector Color	GRAY

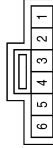

Terminal No.	Color of Wire	Signal Name
3	R/L	TAIL/ILL_RLY
4	R/Y	ILL_CONT_OUT

Connector No.	M201
Connector Name	FRONT HEATED SEAT SWITCH LH
Connector Color	WHITE



Terminal No.	Color of Wire	Signal Name
5	R/L	TAIL/ILL_RLY
6	R/Y	ILL_CONT_OUT

Connector No.	M200
Connector Name	WIRE TO WIRE
Connector Color	WHITE

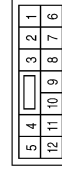

Terminal No.	Color of Wire	Signal Name
8	R/L	—
11	R/Y	—

Connector No.	M88
Connector Name	COMBINATION SWITCH (SPIRAL CABLE)
Connector Color	GRAY



Terminal No.	Color of Wire	Signal Name
19	P	ILL
20	Y	ILL

ALJIA0052GB

# ILLUMINATION

## < COMPONENT DIAGNOSIS >

Connector No.	E17
Connector Name	IPDM E/R (INTELLIGENT POWER DISTRIBUTION MODULE ENGINE ROOM)
Connector Color	WHITE

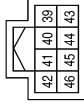

Terminal No.	Color of Wire	Signal Name
39	P	CAN-L
40	L	CAN-H
41	B	S-GND

Connector No.	E6
Connector Name	FUSE BLOCK (J/B)
Connector Color	WHITE



Terminal No.	Color of Wire	Signal Name
9P	R/L	—

Connector No.	M202
Connector Name	FRONT HEATED SEAT SWITCH RH
Connector Color	Color



Terminal No.	Color of Wire	Signal Name
5	R/L	TAIL/ILL. RLY
6	R/Y	ILL. CONT. OUT

Connector No.	E21
Connector Name	JOINT CONNECTOR-E03
Connector Color	WHITE

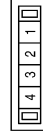

Terminal No.	Color of Wire	Signal Name
7	R/L	TAIL/ILLUMI
12	B	P-GND

Connector No.	E18
Connector Name	IPDM E/R (INTELLIGENT POWER DISTRIBUTION MODULE ENGINE ROOM)
Connector Color	WHITE

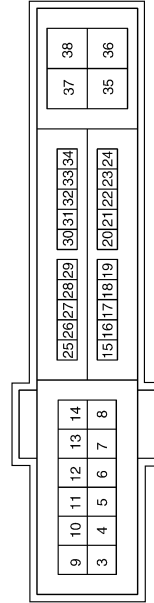

ALJIA0053GB

# ILLUMINATION

## < COMPONENT DIAGNOSIS >

Terminal No.	Color of Wire	Signal Name
8G	P	—
15G	L	—
82G	W/B	—

Connector No.	E30
Connector Name	WIRE TO WIRE
Connector Color	WHITE

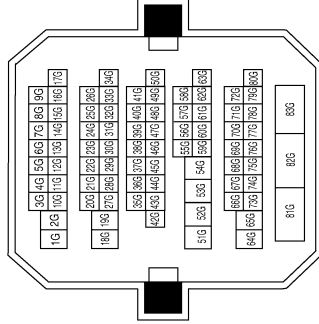

Connector No.	E22
Connector Name	JOINT CONNECTOR-E04
Connector Color	WHITE



Terminal No.	Color of Wire	Signal Name
1	P	—
2	P	—

Connector No.	B8
Connector Name	FRONT DOOR SWITCH LH
Connector Color	WHITE

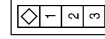

Terminal No.	Color of Wire	Signal Name
2	SB	DOOR SW(DR)

Terminal No.	Color of Wire	Signal Name
17J	SB	—

Connector No.	B1
Connector Name	WIRE TO WIRE
Connector Color	WHITE

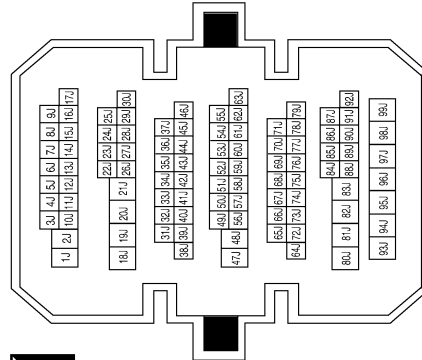

ALJIA0054GB

# ILLUMINATION

## < COMPONENT DIAGNOSIS >

Connector No.	R16
Connector Name	CONSOLE LAMP
Connector Color	—



Terminal No.	Color of Wire	Signal Name
1	L	TAIL/ILL_RLY
2	Y	ILL_CONT_OUT

Connector No.	R10
Connector Name	WIRE TO WIRE
Connector Color	GRAY

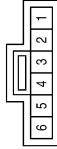

Terminal No.	Color of Wire	Signal Name
5	Y	—
6	L	—

Connector No.	R1
Connector Name	WIRE TO WIRE
Connector Color	WHITE

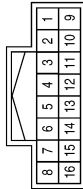

Terminal No.	Color of Wire	Signal Name
5	L	—
14	Y	—

Connector No.	D2
Connector Name	WIRE TO WIRE
Connector Color	WHITE

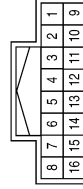

Terminal No.	Color of Wire	Signal Name
8	R/L	—
15	R/Y	—

Connector No.	R54
Connector Name	CONSOLE LAMP
Connector Color	—



Terminal No.	Color of Wire	Signal Name
1	L	TAIL/ILL_RLY
2	Y	ILL_CONT_OUT

Connector No.	R50
Connector Name	WIRE TO WIRE
Connector Color	GRAY



Terminal No.	Color of Wire	Signal Name
5	Y	—
6	L	—

AWJIA0125GB



# ILLUMINATION

< COMPONENT DIAGNOSIS >

Connector No.	D5
Connector Name	DOOR MIRROR REMOTE CONTROL SWITCH
Connector Color	WHITE

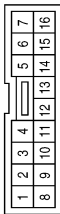

Terminal No.	Color of Wire	Signal Name
8	R/Y	ILL_CONT_OUT
9	R/L	TAIL/ILL_RLY

A  
B  
C  
D  
E  
F  
G  
H  
I  
J  
K  
INL  
M  
N  
O  
P

ALJIA0056GB

# BCM (BODY CONTROL MODULE)

< ECU DIAGNOSIS >

## ECU DIAGNOSIS

---

### BCM (BODY CONTROL MODULE)

#### Description

INFOID:000000001830339

#### REFERENCE VALUES FOR BCM

For BCM reference values, refer to [BCS-41, "Reference Value"](#).

#### TERMINAL LAYOUT FOR BCM

For the terminal layout for the BCM, refer to [BCS-45, "Terminal Layout"](#).

#### PHYSICAL VALUES FOR BCM

For physical values for the BCM, refer to [BCS-45, "Physical Values"](#).

#### WIRING DIAGRAM - BCM

For the BCM wiring diagram, refer to [BCS-64, "Wiring Diagram-Coupe"](#).

#### FAIL SAFE - BCM

For BCM fail safe information, refer to [BCS-81, "Fail Safe"](#).

#### DTC INSPECTION PRIORITY CHART - BCM

For the BCM DTC inspection priority chart, refer to [BCS-83, "DTC Inspection Priority Chart"](#).

#### DTC INDEX - BCM

For the BCM DTC index, refer to [BCS-85, "DTC Index"](#).

# INTERIOR LIGHTING SYSTEM SYMPTOMS

< SYMPTOM DIAGNOSIS >

## SYMPTOM DIAGNOSIS

### INTERIOR LIGHTING SYSTEM SYMPTOMS

#### Symptom Table

INFOID:000000001830340

**CAUTION:**

Perform the self-diagnosis with CONSULT-III before the symptom diagnosis. Perform the trouble diagnosis if any DTC is detected.

Symptom	Possible cause	Inspection item
All the following lamps do not turn ON. • Front room/map lamp LH and RH • Personal lamp rear LH and RH • Trunk room lamp • Step lamp LH and RH • Vanity mirror lamp LH and RH (if equipped)	<ul style="list-style-type: none"> <li>• Harness between BCM and each interior room lamp</li> <li>• BCM</li> </ul>	Interior room lamp power supply circuit Refer to <a href="#">INL-16</a> .
<ul style="list-style-type: none"> <li>• Interior room lamp does not turn ON even though the door is open. (It turns ON when turning the interior room lamp ON.)</li> <li>• Interior room lamp does not turn OFF even though the door is closed.</li> </ul>	<ul style="list-style-type: none"> <li>• Harness between BCM and each door switch</li> <li>• Harness between BCM and each interior room lamp</li> <li>• BCM</li> </ul>	Door switch circuit Refer to <a href="#">DLK-54</a> .  Interior room lamp control circuit Refer to <a href="#">INL-18</a> .
Interior room lamp timer does not activate. (It turns ON/ OFF when the door opens/closes.)	—	Check the interior room lamp setting. Refer to <a href="#">INL-12</a> .
Step lamps do not turn ON. (The front room/map lamps and the personal lamps turn ON.)  Step lamps (driver side and passenger side) do not turn OFF. (The room/map lamps and the personal lamps turn OFF.)	<ul style="list-style-type: none"> <li>• Harness between BCM and each step lamp</li> <li>• BCM</li> </ul>	Step lamp circuit Refer to <a href="#">INL-20</a> .
<ul style="list-style-type: none"> <li>• Trunk room lamp does not turn ON. (The bulb is normal.)</li> <li>• Trunk room lamp does not turn OFF.</li> </ul>	<ul style="list-style-type: none"> <li>• Harness between BCM and trunk room lamp switch</li> <li>• Harness between BCM and trunk room lamp</li> <li>• BCM</li> </ul>	Trunk room lamp switch circuit Refer to <a href="#">INL-22</a> .  Trunk room lamp circuit Refer to <a href="#">INL-22</a> .
Interior room lamp battery saver does not activate.	—	Check the interior room lamp battery saver setting. Refer to <a href="#">INL-12</a> .

A  
B  
C  
D  
E  
F  
G  
H  
I  
J  
K  
L  
M  
N  
O  
P

INL

# PRECAUTIONS

< PRECAUTION >

## PRECAUTION

### PRECAUTIONS

#### Supplemental Restraint System (SRS) "AIR BAG" and "SEAT BELT PRE-TENSIONER"

INFOID:000000001345769

The Supplemental Restraint System such as "AIR BAG" and "SEAT BELT PRE-TENSIONER", used along with a front seat belt, helps to reduce the risk or severity of injury to the driver and front passenger for certain types of collision. This system includes seat belt switch inputs and dual stage front air bag modules. The SRS system uses the seat belt switches to determine the front air bag deployment, and may only deploy one front air bag, depending on the severity of a collision and whether the front occupants are belted or unbelted. Information necessary to service the system safely is included in the SR and SB section of this Service Manual.

#### **WARNING:**

- **To avoid rendering the SRS inoperative, which could increase the risk of personal injury or death in the event of a collision which would result in air bag inflation, all maintenance must be performed by an authorized NISSAN/INFINITI dealer.**
- **Improper maintenance, including incorrect removal and installation of the SRS, can lead to personal injury caused by unintentional activation of the system. For removal of Spiral Cable and Air Bag Module, see the SR section.**
- **Do not use electrical test equipment on any circuit related to the SRS unless instructed to in this Service Manual. SRS wiring harnesses can be identified by yellow and/or orange harnesses or harness connectors.**

#### General precautions for service operations

INFOID:000000001345770

- When removing or disassembling any part, be careful not to damage or deform it. Protect parts which may get in the way with cloth.
- When removing parts with a screw driver or other tool, protect parts by wrapping them with vinyl or tape.
- Keep removed parts protected with cloth.
- If a non-reuseable part is removed, replace it with a new one.
- After re-assembly has been completed, make sure each part functions correctly.
- Never work with wet hands.
- Turn the lighting switch OFF before disconnecting and connecting the connector.
- Do not use organic solvent (paint thinner or gasoline) to clean lamps or remove sealant residue.

# INTERIOR ROOM LAMP

< ON-VEHICLE REPAIR >

## ON-VEHICLE REPAIR

### INTERIOR ROOM LAMP

#### Removal and Installation

INFOID:000000001345771

#### MAP LAMP

##### NOTE:

For non-sunroof equipped vehicles, the map lamp assembly is an integral part of the headlining and repaired only as an assembly. Refer to [INT-19, "Removal and Installation"](#) for coupe models, and [INT-40, "Removal and Installation"](#) for sedan models.

##### Removal (Sunroof Equipped Vehicles)

1. Disconnect the negative battery cable.
2. Release the metal clips and drop front edge of map lamp (1) away from headlining. Slide map lamp forward in vehicle to clear pawls at rear.
3. Disconnect the connectors, then remove map lamp.

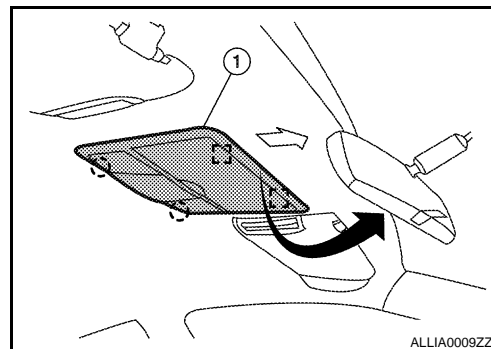

##### Installation (Sunroof Equipped Vehicles)

Installation is in the reverse order of removal.

##### Bulb Replacement

1. Disconnect the negative battery cable.
2. Using a suitable tool (3), remove map lamp lens (2) RH/LH.
3. Pull bulb (1) straight out to remove.

**Map lamp bulb : 12V - 8W**

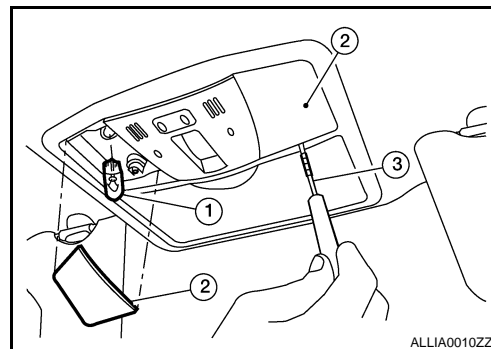

#### VANITY MIRROR LAMP

##### Removal

The vanity mirror lamp is replaced as part of the sunvisor assembly. Refer to [INT-19, "Removal and Installation"](#).

##### Installation

Installation is in the reverse order of removal.

##### Bulb Replacement

1. Disconnect the negative battery cable.

A  
B  
C  
D  
E  
F  
G  
H  
I  
J  
K  
M  
N  
O  
P

INL

## INTERIOR ROOM LAMP

### < ON-VEHICLE REPAIR >

- Using a suitable tool (1), remove the vanity mirror lamp lens (2) RH/LH.
- Pull bulb (3) straight out to remove.

**Vanity mirror lamp bulb : 12V - 2W**

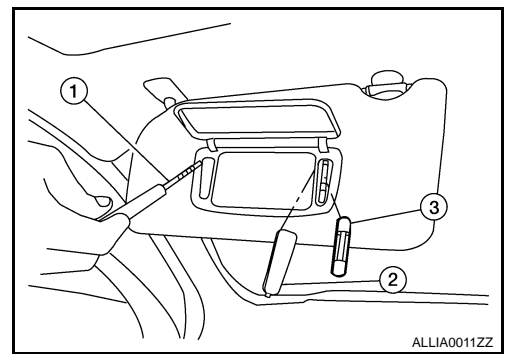

## GLOVE BOX LAMP

### Removal

- Disconnect the negative battery cable.
- Remove the lower instrument glove box assembly (1). Refer to [IP-11, "Removal and Installation"](#).
- Rotate glove box lamp socket (3) counterclockwise to remove.

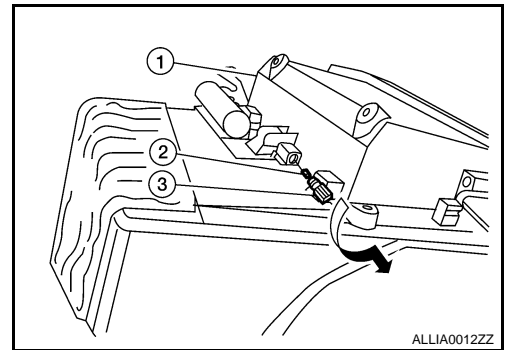

### Installation

Installation is in the reverse order of removal.

### Bulb Replacement

- Disconnect the negative battery cable.
- Remove glove box lamp socket (3).
- Pull bulb (2) straight out to remove.

**Glove box lamp bulb : 12V - 3.4W**

## STEP LAMP

### Removal

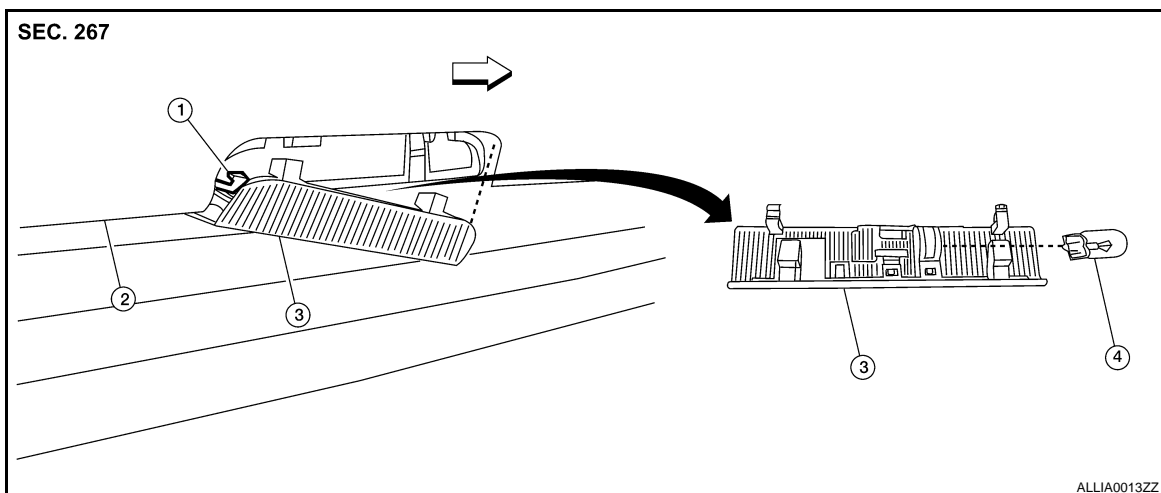

# INTERIOR ROOM LAMP

## < ON-VEHICLE REPAIR >

- |                        |                  |                          |
|------------------------|------------------|--------------------------|
| 1. Step lamp connector | 2. Door finisher | 3. Step lamp lens/socket |
| 4. Step lamp bulb      | ↳ Vehicle front  |                          |

1. Disconnect the negative battery cable.
2. Insert a suitable tool between door finisher (2) and step lamp lens/socket (1) to release the pawls.
3. Disconnect the step lamp connector, then remove step lamp.

### Installation

Installation is in the reverse order of removal.

### Bulb Replacement

1. Disconnect the negative battery cable.
2. Remove the step lamp lens/socket.
3. Pull the bulb straight out to remove.

**Step lamp bulb : 12V - 5W**

## ROOM LAMP (if equipped)

### Removal

1. Disconnect the negative battery cable.
2. Insert a suitable tool between headlining and room lamp (2) to release the clips (A).
3. Disconnect the room lamp connector, then remove the room lamp (2).

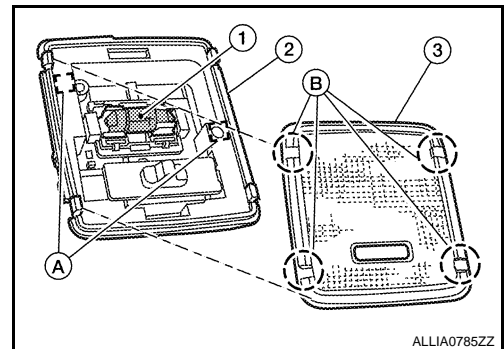

### Installation

Installation is in the reverse order of removal.

### Bulb Replacement

1. Disconnect the negative battery cable.
2. Using a suitable tool, release the pawls (B) and remove room lamp lens (3) from room lamp (2).
3. Pull bulb (1) straight out to remove.

**Room lamp bulb : 12V - 8W**

## PERSONAL LAMP (if equipped)

### Removal

The personal lamp (RH/LH) (1) is replaced as part of the headlining assembly. Refer to [INT-40. "Removal and Installation"](#).

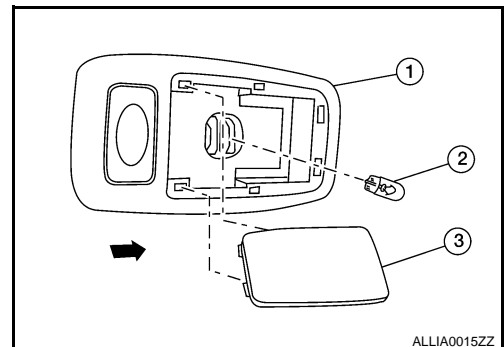

### Installation

## INTERIOR ROOM LAMP

### < ON-VEHICLE REPAIR >

---

Installation is in the reverse order of removal.

#### Bulb Replacement

1. Disconnect the negative battery cable.
2. Using a suitable tool, release the pawls and remove personal lamp lens (3)
3. Pull bulb (2) straight out to remove.

**Personal lamp bulb : 12V - 8W**



# ILLUMINATION

< ON-VEHICLE REPAIR >

## ILLUMINATION

### Removal and Installation

INFOID:000000001345772

#### TRUNK ROOM LAMP

##### Removal

1. Disconnect the negative battery cable.
2. Release the tab (A), then swing open the lens.
3. Remove the bulb (3).
4. Release the tab (B), then pull trunk room lamp (2) away from body opening.
5. Disconnect the connector (1) and remove trunk room lamp.

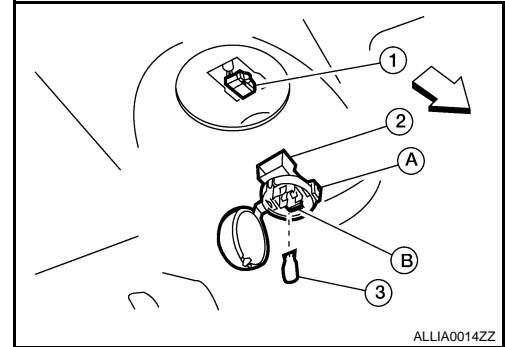

##### Installation

Installation is in the reverse order of removal.

##### Bulb Replacement

1. Disconnect the negative battery cable.
2. Release the tab (A), then swing open the lens.
3. Pull bulb (3) straight out to remove.

**Trunk room lamp bulb**

**: 12V - 3.4W**

A

B

C

D

E

F

G

H

I

J

K

INL

M

N

O

P

## SERVICE DATA AND SPECIFICATIONS (SDS)

< SERVICE DATA AND SPECIFICATIONS (SDS)

## SERVICE DATA AND SPECIFICATIONS (SDS)

### SERVICE DATA AND SPECIFICATIONS (SDS)

#### Bulb Specifications

INFOID:000000001345773

Item	Type	Wattage (W)	Bulb No.*
Map lamp	Wedge	8	B5Y
Push-button ignition switch illumination	LED	-	-
Vanity mirror lamp	Cylinder	2	-
Glove box lamp	Wedge	3.4	658
Step lamp	Wedge	5	-
Room lamp	Cylinder	8	B5Y
Personal Lamp	Wedge	8	B5Y
Trunk room lamp	Wedge	3.4	158

\* Always check with the Parts Department for the latest parts information.