

SECTION **SB**  
SEAT BELTS

A  
B  
C  
D  
E  
F  
G  
SB  
I  
J  
K  
L  
M

CONTENTS

<b>PRECAUTIONS</b> .....	<b>2</b>	<b>COLLISION DIAGNOSIS</b> .....	<b>8</b>
Precautions for Supplemental Restraint System (SRS) "AIR BAG" and "SEAT BELT PRE-TENSIONER" .....	2	Seat Belt Inspection .....	8
Precautions for Seat Belt Service .....	2	AFTER A COLLISION .....	8
After A Collision .....	3	PRELIMINARY CHECKS .....	8
<b>FRONT SEAT BELT</b> .....	<b>4</b>	SEAT BELT RETRACTOR ON-VEHICLE CHECK .....	9
Removal and Installation .....	4	SEAT BELT RETRACTOR OFF-VEHICLE CHECK .....	10
<b>REAR SEAT BELT</b> .....	<b>6</b>	<b>TOP TETHER STRAP CHILD RESTRAINT</b> .....	<b>11</b>
Removal and Installation .....	6	Removal and Installation .....	11
KING CAB MODELS .....	6	KING CAB MODELS .....	11
CREW CAB MODELS .....	7	CREW CAB MODELS .....	11

# PRECAUTIONS

## PRECAUTIONS

PF0:00001

### Precautions for Supplemental Restraint System (SRS) “AIR BAG” and “SEAT BELT PRE-TENSIONER”

EHS000SH

The Supplemental Restraint System such as “AIR BAG” and “SEAT BELT PRE-TENSIONER”, used along with a front seat belt, helps to reduce the risk or severity of injury to the driver and front passenger for certain types of collision. This system may include seat belt switch inputs and dual stage front air bag modules. If equipped with dual stage front air bag modules, the SRS system uses the seat belt switches to determine the front air bag deployment, and may only deploy one front air bag, depending on the severity of a collision and whether the front occupants are belted or unbelted. Information necessary to service the system safely is included in the SRS and SB section of this Service Manual.

The vehicle may be equipped with a passenger air bag deactivation switch. Because no rear seat exists where a rear-facing child restraint can be placed, the switch is designed to turn off the passenger air bag so that a rear-facing child restraint can be used in the front passenger seat. The switch is located in the center of the instrument panel, near the ashtray. When the switch is turned to the ON position, the passenger air bag is enabled and could inflate for certain types of collision. When the switch is turned to the OFF position, the passenger air bag is disabled and will not inflate. A passenger air bag OFF indicator on the instrument panel lights up when the passenger air bag is switched OFF. The driver air bag always remains enabled and is not affected by the passenger air bag deactivation switch.

#### **WARNING:**

- To avoid rendering the SRS inoperative, which could increase the risk of personal injury or death in the event of a collision which would result in air bag inflation, all maintenance must be performed by an authorized NISSAN/INFINITI dealer.
- Improper maintenance, including incorrect removal and installation of the SRS, can lead to personal injury caused by unintentional activation of the system. For removal of Spiral Cable and Air Bag Module, see the SRS section.
- Do not use electrical test equipment on any circuit related to the SRS unless instructed to in this Service Manual. SRS wiring harnesses can be identified by yellow and/or orange harnesses or harness connectors.
- The vehicle may be equipped with a passenger air bag deactivation switch which can be operated by the customer. When the passenger air bag is switched OFF, the passenger air bag is disabled and will not inflate. When the passenger air bag is switched ON, the passenger air bag is enabled and could inflate for certain types of collision. After SRS maintenance or repair, make sure the passenger air bag deactivation switch is in the same position (ON or OFF) as when the vehicle arrived for service.

### Precautions for Seat Belt Service

EHS000SI

#### **CAUTION:**

- Before removing the seat belt pre-tensioner assembly, turn the ignition switch OFF, disconnect both battery cables and wait at least 3 minutes.
- After replacing or reinstalling seat belt pre-tensioner assembly, or reconnecting seat belt pre-tensioner assembly connector, ensure entire SRS operates properly. Refer to [SRS-20, "SRS Operation Check"](#).
- Do not disassemble buckle or seat belt assembly.
- Do not reuse seat belt anchor bolts after removal. Replace with new ones.
- Never oil tongue and buckle.
- If any component (including anchor bolts) of seat belt assembly is questionable, do not repair. Replace the whole seat belt assembly.
- If webbing is cut, frayed, or damaged, replace seat belt assembly.
- When replacing seat belt assembly, use a genuine NISSAN seat belt assembly.

# PRECAUTIONS

## After A Collision

EHS000SJ

### **WARNING:**

- Inspect all seat belt assemblies including retractors, buckles and attaching hardware after any collision.
- NISSAN recommends that all seat belt assemblies in use during a collision be replaced unless the collision was minor and the belts show no damage and continue to operate properly. Failure to do so could result in serious personal injury in an accident. Seat belt assemblies not in use during a collision should also be replaced if either damage or improper operation is noted. Seat belt assemblies which are equipped with pre-tensioners should be replaced even if the seat belts are not in use during a frontal collision in which the air bags are deployed.

Replace any seat belt assembly (including anchor bolts) if:

- The seat belt was in use at the time of a collision (except after minor collisions when the belts, retractors and buckles show no damage and continue to operate properly).
- The seat belt was damaged in an accident (i.e., torn webbing, bent retractor or guide, etc.).
- The seat belt attaching point was damaged in an accident. Inspect the seat belt attaching area for damage or distortion and repair as necessary before installing a new seat belt assembly.
- Anchor bolts are deformed or worn out.
- The seat belt assembly is equipped with a pre-tensioner, even if the seat belt is not in use during a collision in which the air bags are deployed.

A

B

C

D

E

F

G

SB

I

J

K

L

M

# FRONT SEAT BELT

PFP:86880

EHS000SK

## FRONT SEAT BELT

### Removal and Installation

SEC. 868

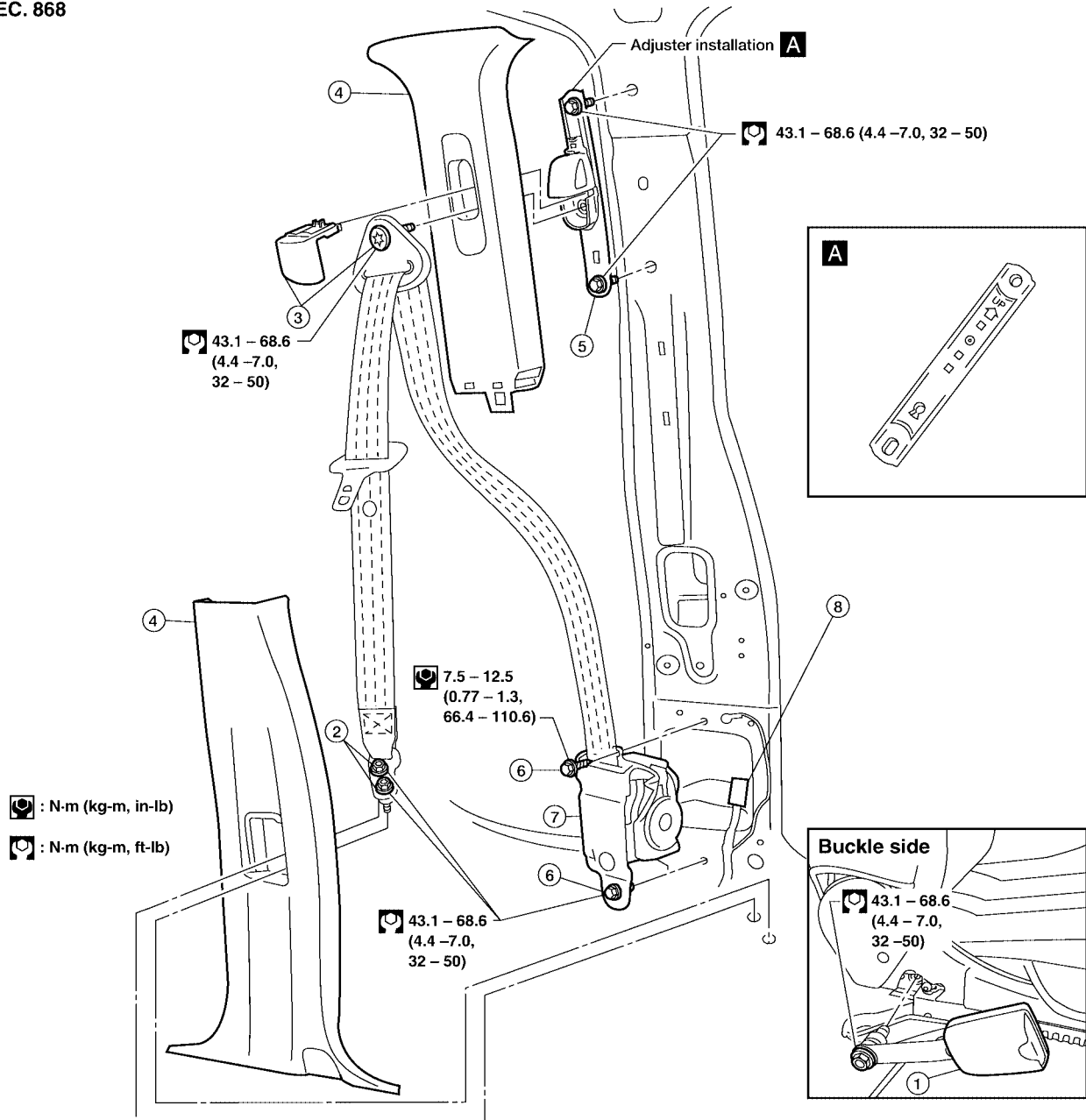

WRS230

#### NOTE:

Remove components in the order shown in the illustration above.

#### NOTE:

Slide the seat all the way forward and tilt the back of the seat toward the front for easier access.

1. Remove buckle. For driver side, disconnect seat belt switch connector.
2. Remove floor anchor bolts.
3. Remove adjuster cover and upper guide loop anchor bolt.
4. Remove center pillar lower and upper garnishes. Refer to [EI-18, "SIDE AND FLOOR TRIM"](#).
5. Remove two adjuster bolts and adjuster assembly.
6. Remove retractor anchor bolt and screw.
7. Remove retractor.

## FRONT SEAT BELT

---

8. Disconnect seat belt pre-tensioner connector.
  - When disconnecting or connecting direct-connect SRS connectors, refer to [SRS-8, "Direct-connect SRS Component Connectors"](#) .
9. Installation is in the reverse order of removal.

A

B

C

D

E

F

G

SB

I

J

K

L

M

# REAR SEAT BELT

PF88840

EHS000SL

## REAR SEAT BELT

### Removal and Installation KING CAB MODELS

SEC. 869

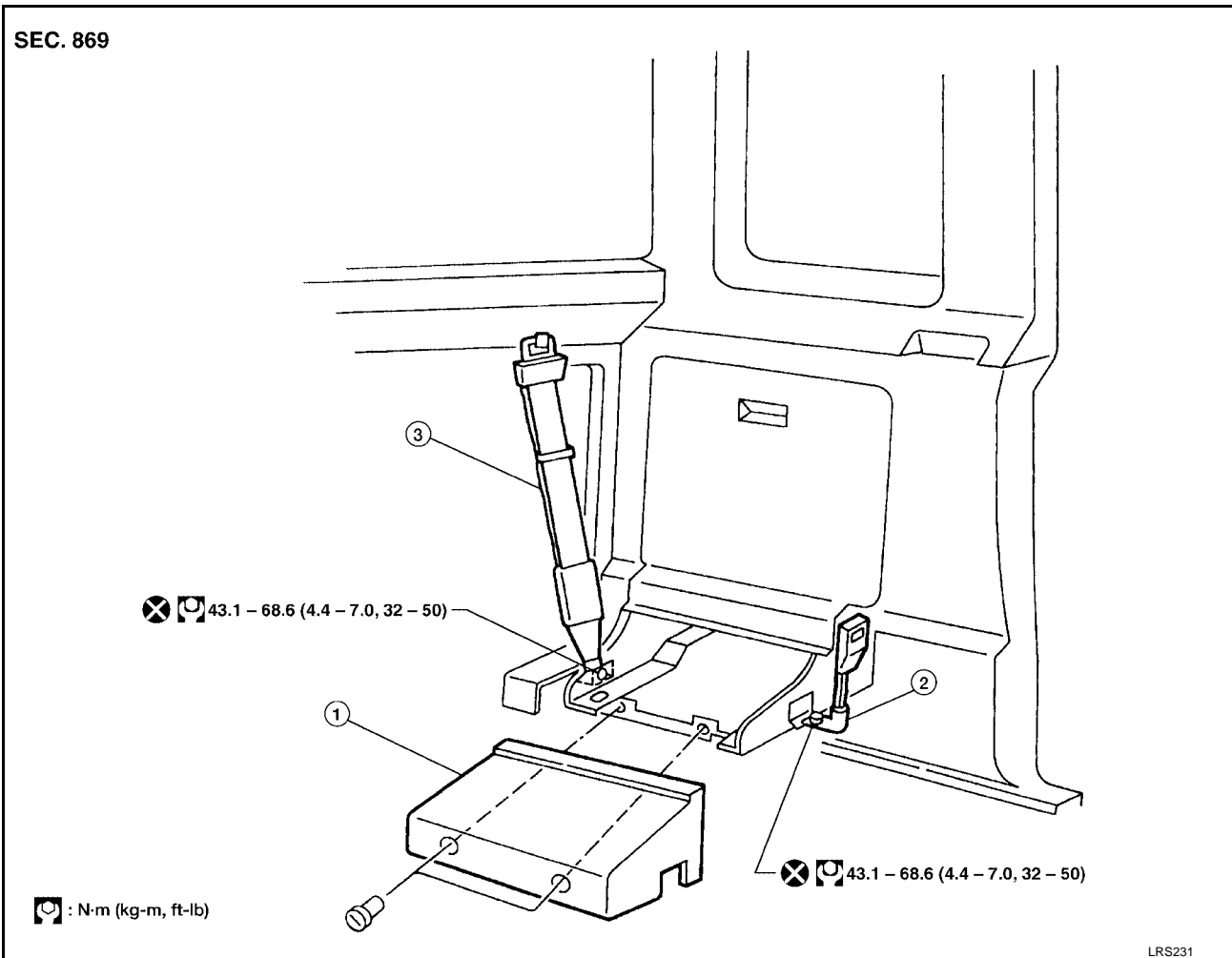

#### NOTE:

Remove components in the order shown in the illustration above.

1. Remove under seat storage.
2. Remove buckle.
3. Remove seat belt anchor bolt.
4. Installation is in the reverse order of removal.

# REAR SEAT BELT

## CREW CAB MODELS

A  
B  
C  
D  
E  
F  
G  
SB  
I  
J  
K  
L  
M

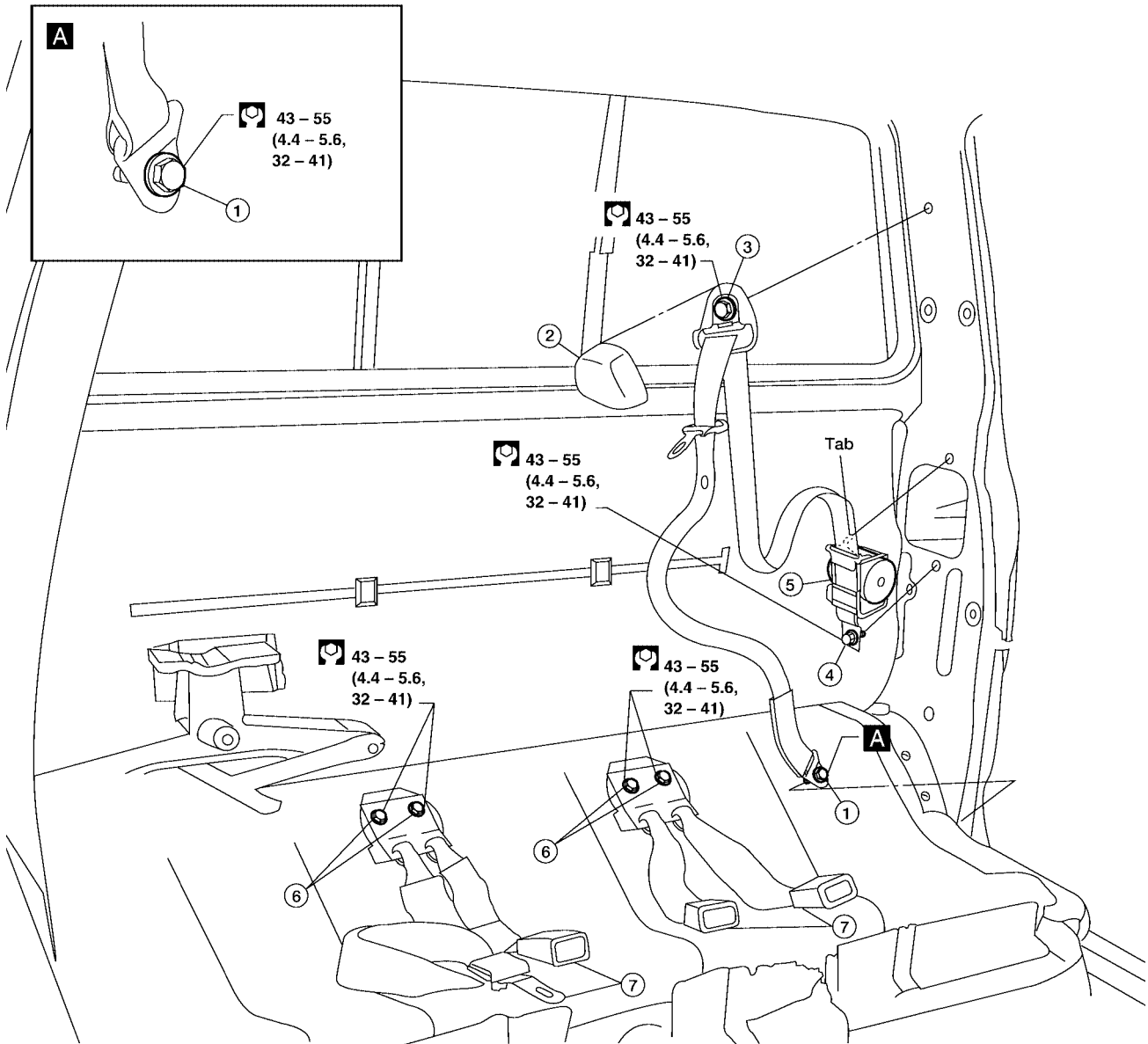

 N-m (kg-m, ft-lb)

WRS258

### NOTE:

Remove components in the order shown in the illustration above.

1. Remove lower seat belt anchor bolt.
2. Remove shoulder anchor cover.
3. Remove shoulder anchor bolt.
4. Remove retractor bolt.
5. Remove retractor.
6. Remove anchor bolts.
7. Remove seat belt assembly.
8. Installation is in the reverse order of removal.

## COLLISION DIAGNOSIS

### Seat Belt Inspection AFTER A COLLISION

#### **WARNING:**

Inspect all seat belt assemblies including retractors and attaching hardware after any collision. NISSAN recommends that all seat belt assemblies in use during a collision be replaced unless the collision was minor and the belts show no damage and continue to operate properly. Failure to do so could result in serious personal injury in an accident. Seat belt assemblies not in use during a collision should also be replaced if either damage or improper operation is noted. Seat belt assemblies which are equipped with pre-tensioners should be replaced even if the seat belts are not in use during a frontal collision in which the air bags are deployed.

Replace any seat belt assembly (including anchor bolts) if:

- The seat belt was in use at the time of a collision (except after minor collisions when the belts, retractors and buckles show no damage and continue to operate properly.)
- The seat belt was damaged in an accident (i.e. torn webbing, bent retractor or guide, etc.).
- The seat belt attaching point was damaged in an accident. Inspect the seat belt attaching area for damage or distortion and repair as necessary before installing a new seat belt assembly.
- The seat belt assembly is equipped with a pre-tensioner, even if the seat belt is not in use during a collision in which the air bags are deployed.

#### **PRELIMINARY CHECKS**

1. Check the seat belt warning lamp/chime for proper operation as follows:
  - a. Switch ignition ON. With driver seat belt unfastened, the seat belt warning lamp should illuminate. Also, the seat belt warning chime should sound for about seven seconds.
  - b. Fasten driver seat belt. The seat belt warning lamp should go out and the chime (if sounding) should stop.
2. If the "AIR BAG" warning lamp is blinking, conduct self-diagnosis using CONSULT-II and "AIR BAG" warning lamp. Refer to [SRS-20, "SRS Operation Check"](#).
3. Check that the seat belt retractor, seat belt anchor and buckle bolts are securely attached.
4. Check the shoulder seat belt guide and shoulder belt height adjuster for front seats. Ensure guide swivels freely and that belt lays flat and does not bind in guide. Ensure height adjuster operates properly and holds securely.
5. Check retractor operation:
  - a. Fully extend the seat belt webbing and check for twists, tears or other damage.
  - b. Allow the seat belt to retract. Ensure that belt returns smoothly and completely into the retractor. If the seat belt does not return smoothly, wipe the inside of the loops with a clean paper cloth etc. Dirt built up in the loops of the upper anchors can cause the seat belts to retract slowly.
  - c. Fasten the seat belt. Pull firmly on belt and buckle to ensure belt remains latched. Unfasten seat belt. Ensure belt releases freely and buckle button returns to original position.
6. For non-retractable seat belts, check that the seat belts are accessible. Check seat belt webbing for twists, tears or other damage. Fasten the seat belt. Pull firmly on belt and buckle to ensure belt remains latched. Unfasten seat belts. Ensure belt releases freely and buckle button returns to original position.
7. Repeat steps above as necessary to check the other seat belts.

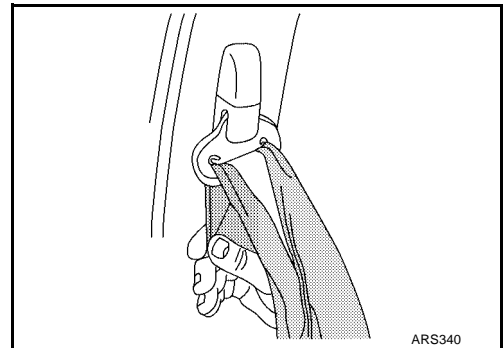



# COLLISION DIAGNOSIS

## SEAT BELT RETRACTOR ON-VEHICLE CHECK

### Emergency Locking Retractors (ELR) and Automatic Locking Retractors (ALR)

#### NOTE:

All seat belt retractors are of the Emergency Locking (ELR) type. In an emergency (sudden stop) the retractor will lock and prevent the belt from extending any further. All outboard 3-point type seat belt retractors except the driver seat belt also have an Automatic Locking (ALR) mode. The ALR mode (also called child restraint mode) is used when installing child seats in outboard seating positions. The ALR mode is activated when the seat belt is fully extended. When the belt is then retracted partially, the ALR mode automatically locks the seat belt in a specific position so the belt cannot be extended any further. To cancel the ALR mode, allow the seat belt to fully wind back into the retractor.

Check the seat belt retractors using the following test(s) to determine if a retractor assembly is operating properly.

#### ELR Function Stationary Check

Grasp the shoulder belt and pull forward quickly. The retractor should lock and prevent the belt from extending further.

#### ALR Function Stationary Check

1. Pull out entire length of seat belt from retractor until a click is heard.
2. Retract the belt partially. A clicking noise should be heard as the belt retracts, indicating that the retractor is in the Automatic Locking (ALR) mode.
3. Grasp the seat belt and try to pull out of retractor. The belt must lock and not extend any further. If NG, replace the retractor assembly.
4. Allow the entire length of the belt to retract to cancel the automatic locking mode.

#### ELR Function Moving Check (all outboard seating positions)

#### WARNING:

Perform the following test in a safe, open area clear of other vehicles and obstructions (for example, a large, empty parking lot). Road surface must be paved and dry. DO NOT perform the following test on wet roads, gravel roads, public streets or highways. This could result in an accident and serious personal injury. The driver and passenger must be prepared to brace themselves in the event the retractor does not lock.

1. Fasten driver seat belt. Buckle a passenger into the seat for the belt that is to be tested.
2. Proceed to the designated safe area.
3. Drive the vehicle at approximately 16 km/h (10 mph). Notify any passengers of a pending sudden stop and the driver and passenger must be prepared to brace themselves in the event the retractor does not lock. Apply brakes firmly and make a very hard stop.
4. During stop, seat belts should lock and not extend. If the seat belt retractor assembly does not lock, perform the seat belt retractor off-vehicle check. Refer to [SB-10, "SEAT BELT RETRACTOR OFF-VEHICLE CHECK"](#).

# COLLISION DIAGNOSIS

## SEAT BELT RETRACTOR OFF-VEHICLE CHECK

1. Remove the seat belt retractor assembly.
2. Slowly pull out belt while tilting the retractor assembly forward from the mounted position as shown in the illustration.

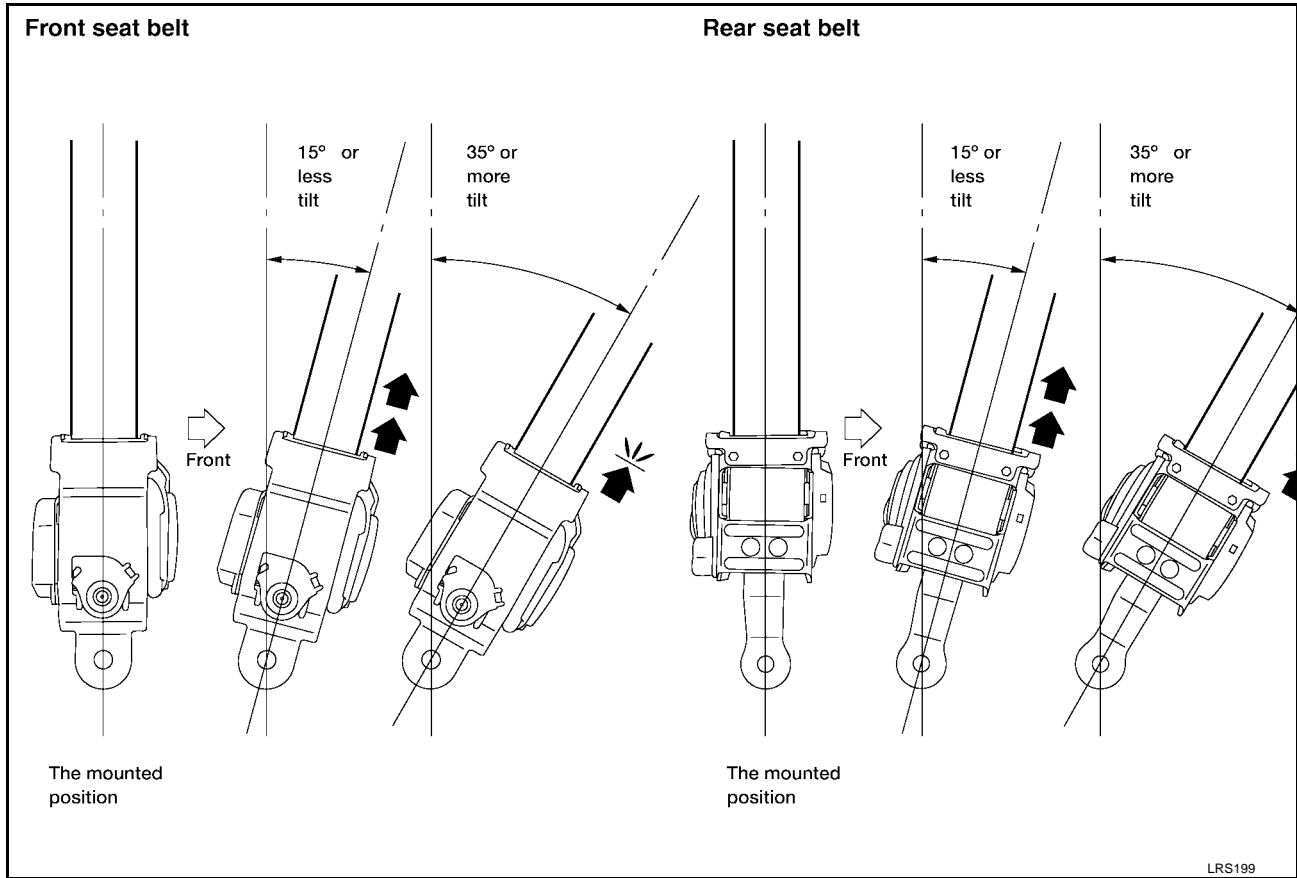

**15 degrees or less tilt : Belt can be pulled out.**

**35 degrees or more tilt : Belt locks and cannot be pulled out.**

3. If NG, replace the retractor assembly.

# TOP TETHER STRAP CHILD RESTRAINT

PFP:88000

EHS000SN

## TOP TETHER STRAP CHILD RESTRAINT

### Removal and Installation KING CAB MODELS

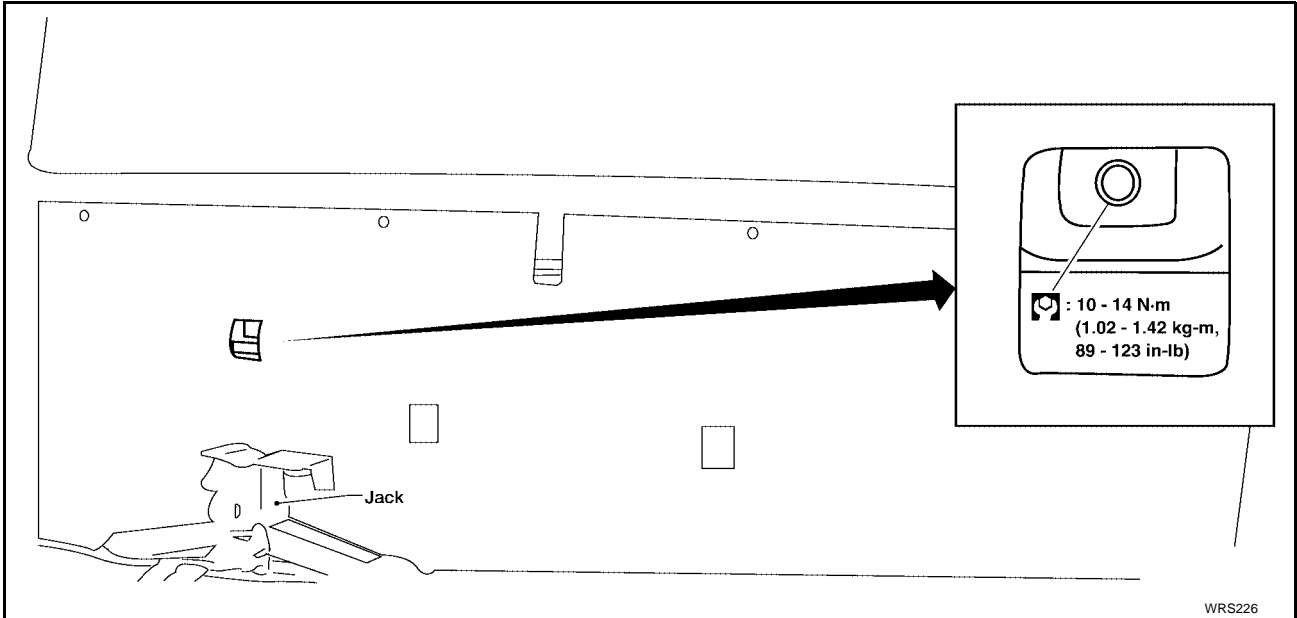

**CAUTION:**  
Replace anchor bolts if they are deformed or worn out.

### CREW CAB MODELS

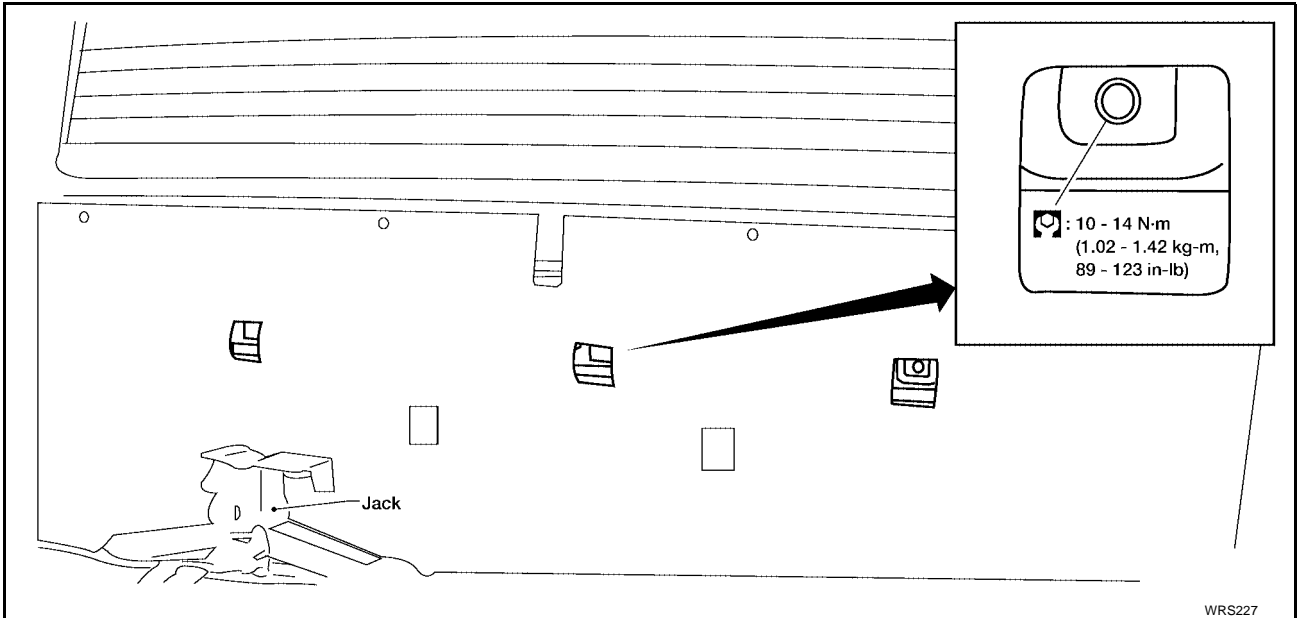

**CAUTION:**  
Replace anchor bolts if they are deformed or worn out.

A  
B  
C  
D  
E  
F  
G  
I  
J  
K  
L  
M

SB

# TOP TETHER STRAP CHILD RESTRAINT

---