

MWI

SECTION

METER, WARNING LAMP & INDICATOR

A
B
C
D
E
F
G
H
I
J
K
L
M
O
P

CONTENTS

BASIC INSPECTION	3	FUEL GAUGE : Component Description	12
DIAGNOSIS AND REPAIR WORKFLOW	3	ENGINE OIL PRESSURE GAUGE	12
Work Flow	3	ENGINE OIL PRESSURE GAUGE : System Dia-	12
FUNCTION DIAGNOSIS	4	gram	12
METER SYSTEM	4	ENGINE OIL PRESSURE GAUGE : System De-	12
METER SYSTEM	4	scription	12
METER SYSTEM : System Diagram	4	ENGINE OIL PRESSURE GAUGE : Component	12
METER SYSTEM : System Description	4	Parts Location	12
METER SYSTEM : Arrangement of Combination		ENGINE OIL PRESSURE GAUGE : Component	13
Meter	5	Description	13
METER SYSTEM : Component Parts Location	6	VOLTAGE GAUGE	13
METER SYSTEM : Component Description	6	VOLTAGE GAUGE : System Diagram	13
SPEEDOMETER	7	VOLTAGE GAUGE : System Description	13
SPEEDOMETER : System Diagram	7	VOLTAGE GAUGE : Component Parts Location	14
SPEEDOMETER : System Description	7	VOLTAGE GAUGE : Component Description	14
SPEEDOMETER : Component Parts Location	7	ODO/TRIP METER	14
SPEEDOMETER : Component Description	8	ODO/TRIP METER : System Diagram	14
TACHOMETER	8	ODO/TRIP METER : System Description	15
TACHOMETER : System Diagram	8	ODO/TRIP METER : Component Parts Location	15
TACHOMETER : System Description	8	ODO/TRIP METER : Component Description	15
TACHOMETER : Component Parts Location	9	SHIFT POSITION INDICATOR	15
TACHOMETER : Component Description	9	SHIFT POSITION INDICATOR : System Diagram	16
ENGINE COOLANT TEMPERATURE GAUGE	9	SHIFT POSITION INDICATOR : System Descrip-	16
ENGINE COOLANT TEMPERATURE GAUGE :		tion	16
System Diagram	9	SHIFT POSITION INDICATOR : Component	16
ENGINE COOLANT TEMPERATURE GAUGE :		Parts Location	16
System Description	10	SHIFT POSITION INDICATOR : Component De-	17
ENGINE COOLANT TEMPERATURE GAUGE :		scription	17
Component Parts Location	10	WARNING LAMPS/INDICATOR LAMPS	17
ENGINE COOLANT TEMPERATURE GAUGE :		WARNING LAMPS/INDICATOR LAMPS : System	17
Component Description	10	Diagram	17
FUEL GAUGE	10	WARNING LAMPS/INDICATOR LAMPS : System	17
FUEL GAUGE : System Diagram	11	Description	17
FUEL GAUGE : System Description	11	WARNING LAMPS/INDICATOR LAMPS : Com-	17
FUEL GAUGE : Component Parts Location	11	ponent Parts Location	17
		WARNING LAMPS/INDICATOR LAMPS : Com-	18
		ponent Description	18

MWI

TRIP COMPUTER	18	Fail Safe	56
TRIP COMPUTER : System Diagram	18	DTC Index	58
TRIP COMPUTER : System Description	18		
TRIP COMPUTER : Component Parts Location ...	19	BCM (BODY CONTROL MODULE)	59
TRIP COMPUTER : Component Description	20	Reference Value	59
COMPASS	21	Terminal Layout	62
Description	21	Physical Values	62
DIAGNOSIS SYSTEM (METER)	23	Wiring Diagram	68
Diagnosis Description	23	Fail Safe	71
CONSULT-III Function (METER/M&A)	24	DTC Inspection Priority Chart	72
COMPONENT DIAGNOSIS	27	DTC Index	72
DTC U1000 CAN COMMUNICATION	27	IPDM E/R (INTELLIGENT POWER DISTRI- BUTION MODULE ENGINE ROOM)	74
DTC Logic	27	Reference Value	74
Diagnosis Procedure	27	Terminal Layout	76
DTC B2205 VEHICLE SPEED CIRCUIT	28	Physical Values	76
Description	28	Wiring Diagram	80
DTC Logic	28	Fail Safe	84
Diagnosis Procedure	28	DTC Index	86
POWER SUPPLY AND GROUND CIRCUIT	29	SYMPTOM DIAGNOSIS	87
COMBINATION METER	29	THE FUEL GAUGE POINTER DOES NOT MOVE	87
COMBINATION METER : Diagnosis Procedure ...	29	Description	87
BCM (BODY CONTROL MODULE)	29	Diagnosis Procedure	87
BCM (BODY CONTROL MODULE) : Diagnosis Procedure	29	THE FUEL GAUGE POINTER DOES NOT MOVE TO "F" WHEN REFUELING	88
IPDM E/R (INTELLIGENT POWER DISTRI- BUTION MODULE ENGINE ROOM)	30	Description	88
IPDM E/R (INTELLIGENT POWER DISTRI- BUTION MODULE ENGINE ROOM) : Diagnosis Pro- cedure	30	Diagnosis Procedure	88
FUEL LEVEL SENSOR SIGNAL CIRCUIT	32	THE OIL PRESSURE WARNING LAMP DOES NOT TURN ON	89
Description	32	Description	89
Component Function Check	32	Diagnosis Procedure	89
Diagnosis Procedure	32	THE OIL PRESSURE WARNING LAMP DOES NOT TURN OFF	90
Component Inspection	33	Description	90
OIL PRESSURE SWITCH SIGNAL CIRCUIT ...	34	Diagnosis Procedure	90
Description	34	NORMAL OPERATING CONDITION	91
Component Function Check	34	COMPASS	91
Diagnosis Procedure	34	COMPASS : Description	91
Component Inspection	34	PRECAUTION	92
COMPASS	35	PRECAUTIONS	92
Wiring Diagram	35	Supplemental Restraint System (SRS) "AIR BAG" and "SEAT BELT PRE-TENSIONER"	92
ECU DIAGNOSIS	38	ON-VEHICLE REPAIR	93
COMBINATION METER	38	COMBINATION METER	93
Reference Value	38	Removal and Installation	93
Wiring Diagram	40		

DIAGNOSIS AND REPAIR WORKFLOW

< BASIC INSPECTION >

BASIC INSPECTION

DIAGNOSIS AND REPAIR WORKFLOW

Work Flow

INFOID:000000004056873

DETAILED FLOW

1.CONFIRM SYMPTOM

Confirm symptom or customer complaint.

>> GO TO 2

2.CHECK SELF-DIAGNOSIS OPERATION OF COMBINATION METER

Perform self-diagnosis of combination meter. Refer to [MWI-23, "Diagnosis Description"](#).

Does self-diagnosis mode operate?

YES >> GO TO 3

NO >> Check power supply and ground circuit of combination meter. Refer to [MWI-29, "COMBINATION METER : Diagnosis Procedure"](#). Then, GO TO 4

3.CHECK COMBINATION METER (CONSULT-III)

Select "METER/M&A" on CONSULT-III and perform "SELF-DIAGNOSIS" of combination meter. Refer to [MWI-24, "CONSULT-III Function \(METER/M&A\)"](#).

Self-diagnostic results content

No malfunction detected>>Repair or replace the cause of symptom. Then, GO TO 4

Malfunction detected>>Refer to [MWI-58, "DTC Index"](#). Then, GO TO 4

4.CONFIRM OPERATION

Does the combination meter operate normally?

YES or NO

YES >> Inspection End.

NO >> GO TO 1

A
B
C
D
E
F
G
H
I
J
K
L
M
O
P

MWI

METER SYSTEM

< FUNCTION DIAGNOSIS >

FUNCTION DIAGNOSIS

METER SYSTEM

METER SYSTEM

METER SYSTEM : System Diagram

INFOID:000000004056874

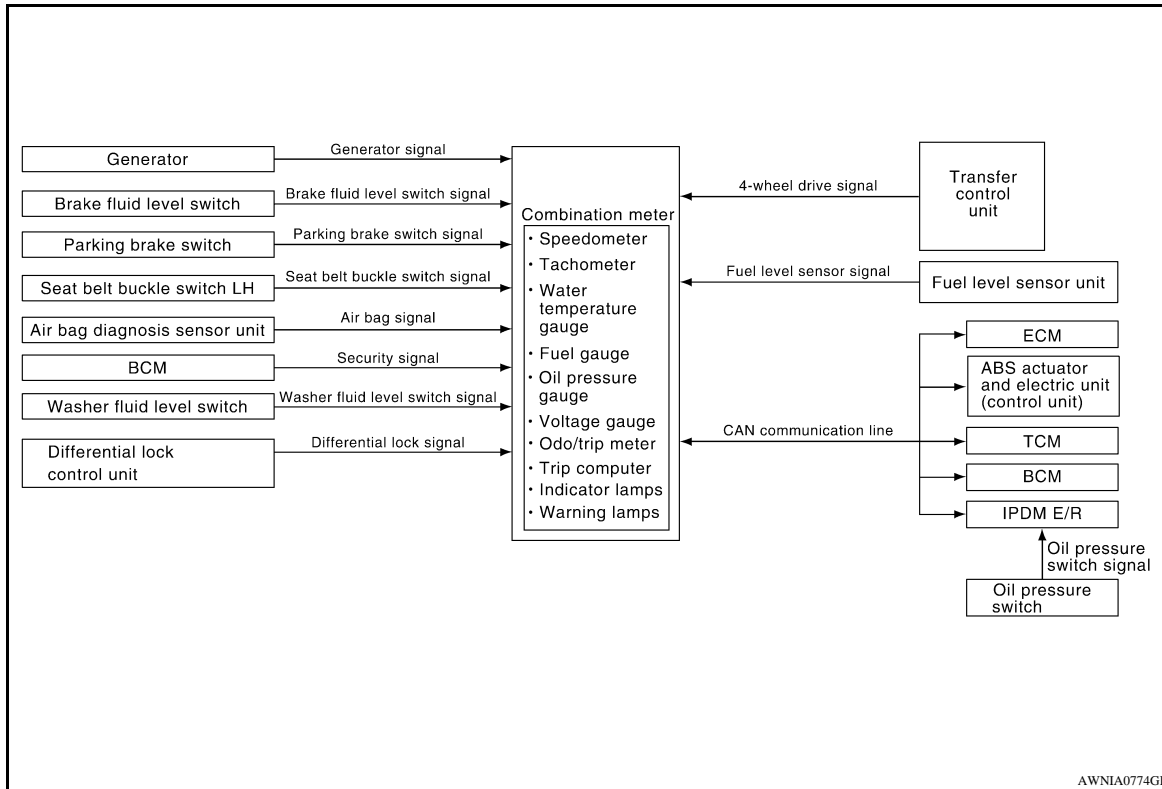

METER SYSTEM : System Description

INFOID:000000004056875

COMBINATION METER

- Speedometer, odo/trip meter, tachometer, fuel gauge, engine coolant temperature gauge, engine oil pressure gauge (with VQ40DE), voltage gauge (with VQ40DE) and trip computer (with trip computer) are controlled by the unified meter control unit, which is built into the combination meter.
- Warning and indicator lamps are controlled by the unified meter control unit and by components connected directly to the combination meter.
- Digital meter is adopted for odo/trip meter*, as well as the A/T position indicator display.
*The record of the odometer is kept even if the battery cable is disconnected. The record of the trip meter is erased when the battery cable is disconnected.
- Odo/trip meter and A/T indicator segments can be checked in diagnosis mode.
- Meter/gauge can be checked in diagnosis mode.

NOTE:

Under the following conditions, the meters will perform a homing function. The meter pointers will move down slightly and then move back to the resting position. This is a normal design condition.

- Approximately 60 seconds after turning the ignition switch from the ON to the OFF position
- If the battery is disconnected and then reconnected

METER SYSTEM

< FUNCTION DIAGNOSIS >

METER SYSTEM : Arrangement of Combination Meter

INFOID:000000004056876

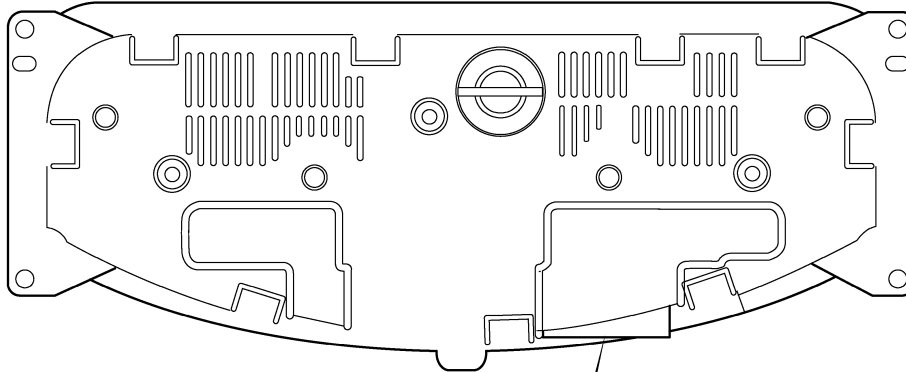
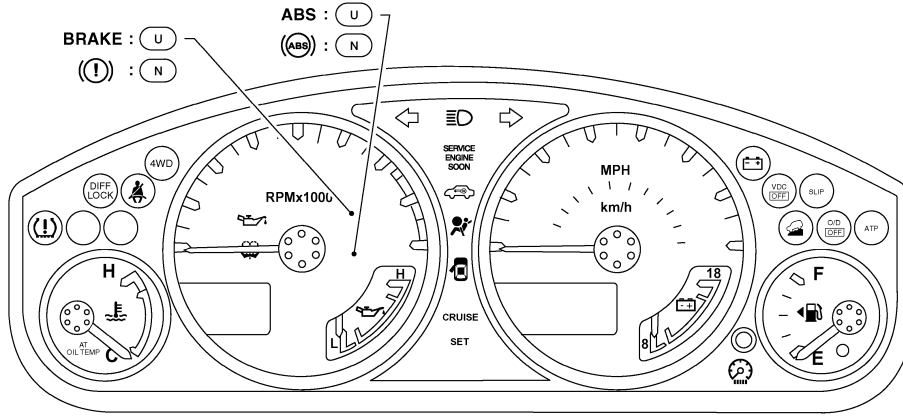

20	19	18	17	16	15	14	13	12	11	10	9	8	7	6	5	4	3	2	1	(M24)
40	39	38	37	36	35	34	33	32	31	30	29	28	27	26	25	24	23	22	21	

(N) : Canada

(U) : USA

WKIA4987E

A
B
C
D
E
F
G
H
I
J
K
L
M
N
O
P

MWI

METER SYSTEM

< FUNCTION DIAGNOSIS >

METER SYSTEM : Component Parts Location

INFOID:000000004056877

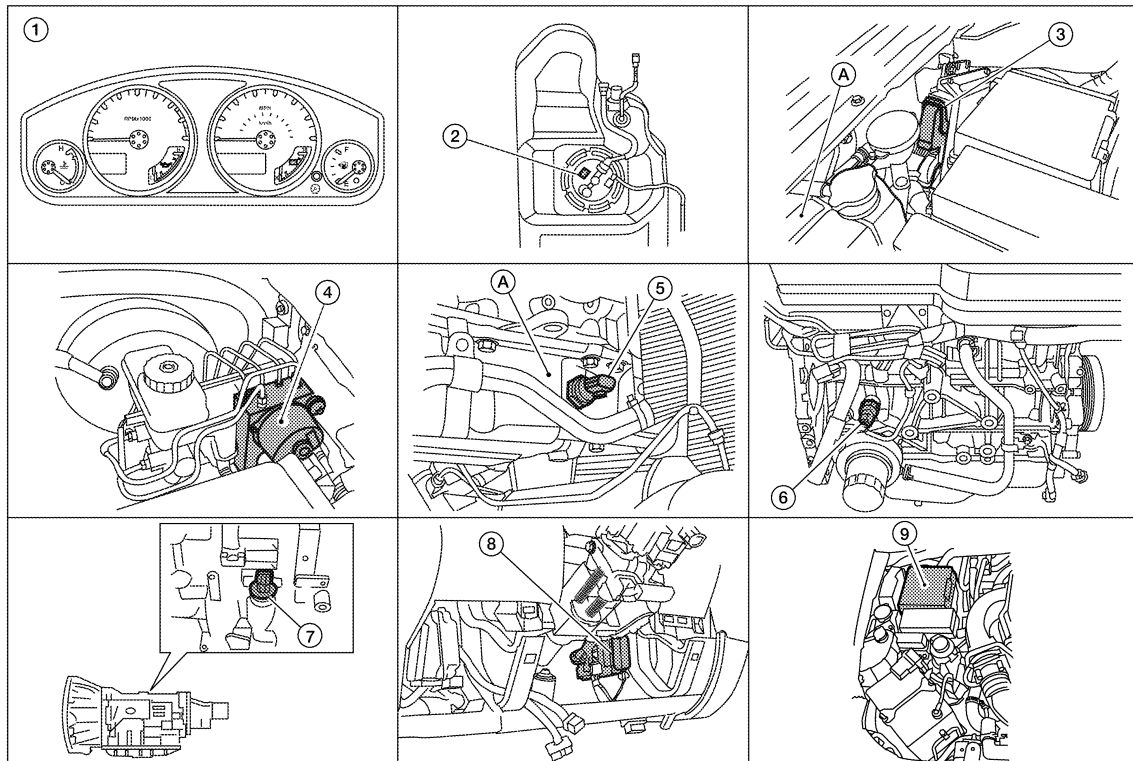

AWNLA0781ZZ

- | | | |
|---|--|--|
| 1. Combination meter M24 | 2. Fuel level sensor unit and fuel pump C5 (view with fuel tank removed) | 3. ECM E16 (view with ECM cover removed)
A. Coolant reservoir |
| 4. ABS actuator and electric unit (control unit)
E125 (without VDC)
E127 (with VDC) | 5. Oil pressure switch E208 (with VQ40DE)
A. Oil pan (upper) | 6. Oil pressure switch F4 (with QR25DE) (view with engine removed) |
| 7. A/T assembly F9 | 8. BCM M18, M19 (view with lower instrument panel LH removed) | |

METER SYSTEM : Component Description

INFOID:000000004056878

Unit	Description
Combination meter	<p>Controls the following with the signals received from each unit via CAN communication and the signals from switches and sensors.</p> <ul style="list-style-type: none"> • Speedometer • Engine coolant temperature gauge • Engine oil pressure gauge • Voltage gauge • Warning lamps • Trip computer • Tachometer • Fuel gauge • Odo/trip meter • Indicator lamps • Warning chime
IPDM E/R	IPDM E/R reads the ON/OFF signals of the oil pressure switch and transmits the oil pressure switch signal to the combination meter via BCM with CAN communication line.
Fuel level sensor unit	Refer to MWI-32, "Description" .
Oil pressure switch	Refer to MWI-34, "Description" .

METER SYSTEM

< FUNCTION DIAGNOSIS >

Unit	Description
ECM	Transmits the following signals to the combination meter with CAN communication line. <ul style="list-style-type: none"> • Engine speed signal • Engine coolant temperature signal • Fuel consumption monitor signal
ABS actuator and electric unit (control unit)	Transmits the vehicle speed signal to the combination meter with CAN communication line.
BCM	<ul style="list-style-type: none"> • Transmits signals provided by various units to the combination meter with CAN communication line. • Transmits the security signal to the combination meter.
TCM	Transmits shift position signal to the combination meter with CAN communication line.

SPEEDOMETER

SPEEDOMETER : System Diagram

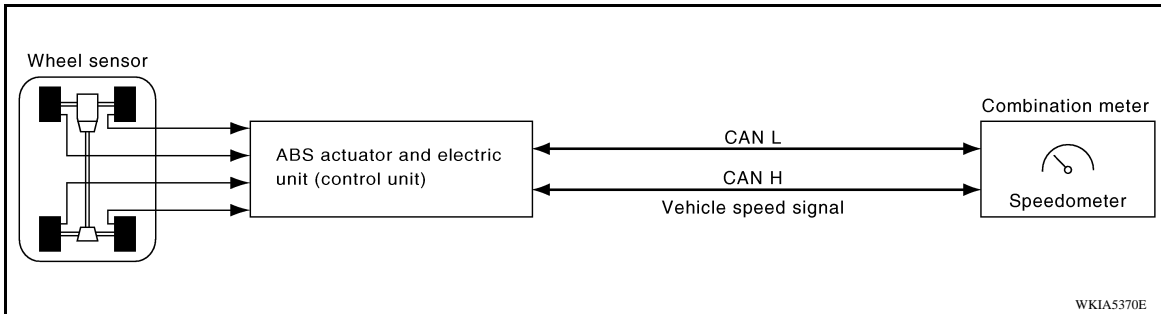

SPEEDOMETER : System Description

The ABS actuator and electric unit (control unit) provides a vehicle speed signal to the combination meter via CAN communication lines.

SPEEDOMETER : Component Parts Location

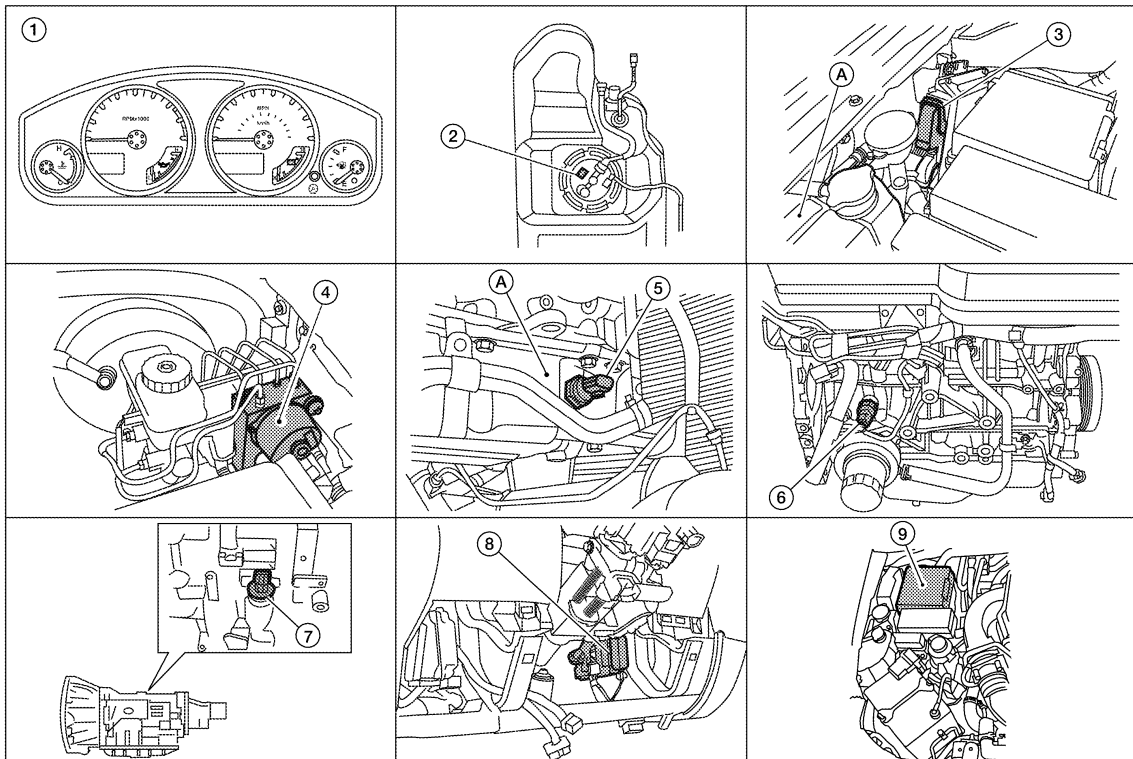

METER SYSTEM

< FUNCTION DIAGNOSIS >

- | | | |
|---|--|--|
| 1. Combination meter M24 | 2. Fuel level sensor unit and fuel pump C5 (view with fuel tank removed) | 3. ECM E16 (view with ECM cover removed)
A. Coolant reservoir |
| 4. ABS actuator and electric unit (control unit)
E125 (without VDC)
E127 (with VDC) | 5. Oil pressure switch E208 (with VQ40DE)
A. Oil pan (upper) | 6. Oil pressure switch F4 (with QR25DE) (view with engine removed) |
| 7. A/T assembly F9 | 8. BCM M18, M19 (view with lower instrument panel LH removed) | |

SPEEDOMETER : Component Description

INFOID:000000004056882

Unit	Description
Combination meter	Indicates the vehicle speed according to the vehicle speed signal received from ABS actuator and electric unit (control unit) via CAN communication.
ABS actuator and electric unit (control unit)	Transmits the vehicle speed signal to the combination meter with CAN communication line.

TACHOMETER

TACHOMETER : System Diagram

INFOID:000000004056883

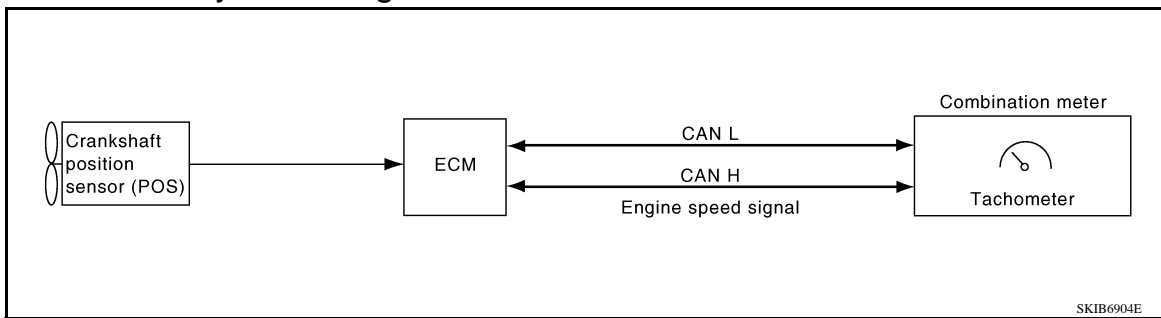

TACHOMETER : System Description

INFOID:000000004056884

The tachometer indicates engine speed in revolutions per minute (rpm).
The ECM provides an engine speed signal to the combination meter via CAN communication lines.

METER SYSTEM

< FUNCTION DIAGNOSIS >

TACHOMETER : Component Parts Location

INFOID:000000004459287

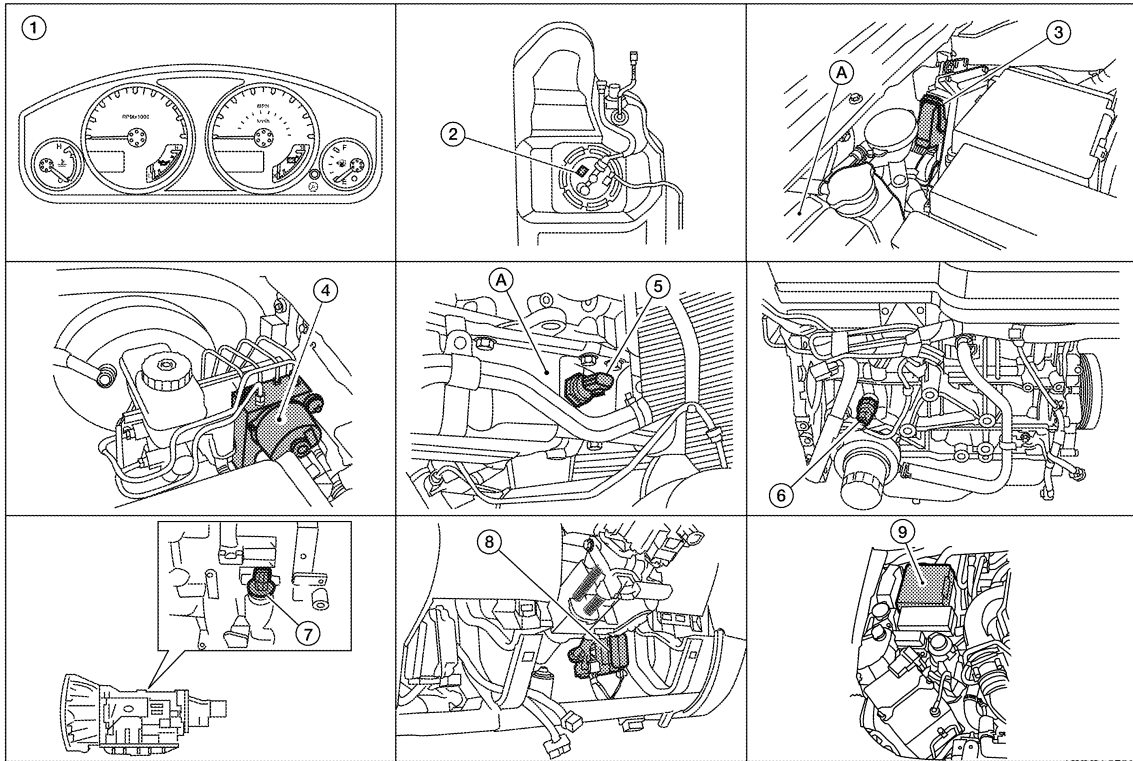

AWNIA0781ZZ

- | | | |
|---|--|--|
| 1. Combination meter M24 | 2. Fuel level sensor unit and fuel pump C5 (view with fuel tank removed) | 3. ECM E16 (view with ECM cover removed)
A. Coolant reservoir |
| 4. ABS actuator and electric unit (control unit)
E125 (without VDC)
E127 (with VDC) | 5. Oil pressure switch E208 (with VQ40DE)
A. Oil pan (upper) | 6. Oil pressure switch F4 (with QR25DE) (view with engine removed) |
| 7. A/T assembly F9 | 8. BCM M18, M19 (view with lower instrument panel LH removed) | |

TACHOMETER : Component Description

INFOID:0000000004056886

Unit	Description
Combination meter	Indicates the engine speed in RPM according to the engine speed signal received from ECM via CAN communication.
ECM	Transmits the engine speed signal to the combination meter with CAN communication line.

ENGINE COOLANT TEMPERATURE GAUGE

ENGINE COOLANT TEMPERATURE GAUGE : System Diagram

INFOID:0000000004056887

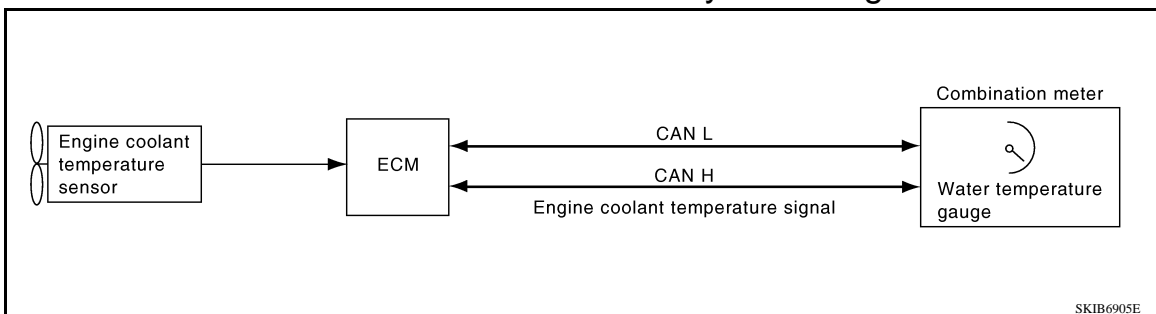

SKIB6905E

METER SYSTEM

< FUNCTION DIAGNOSIS >

ENGINE COOLANT TEMPERATURE GAUGE : System Description

INFOID:000000004056888

The engine coolant temperature gauge indicates the engine coolant temperature. The ECM provides an engine coolant temperature signal to the combination meter via CAN communication lines.

ENGINE COOLANT TEMPERATURE GAUGE : Component Parts Location

INFOID:000000004056888

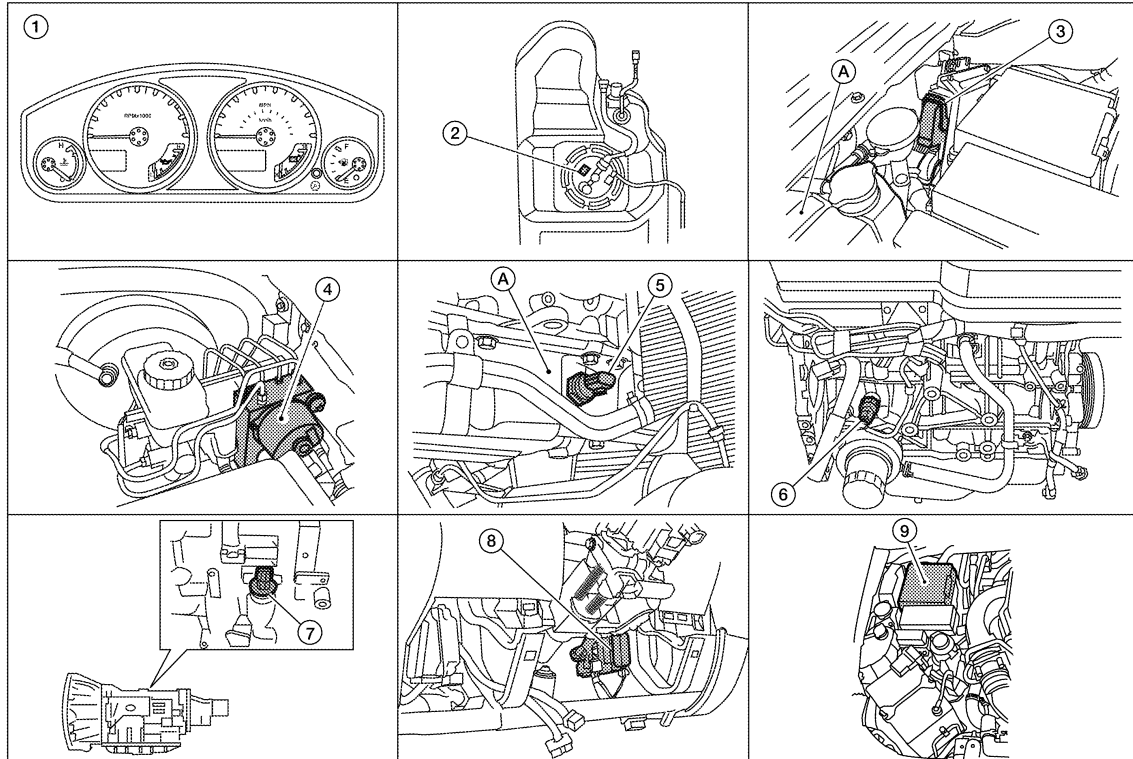

AWNLA0781ZZ

- | | | |
|---|--|--|
| 1. Combination meter M24 | 2. Fuel level sensor unit and fuel pump C5 (view with fuel tank removed) | 3. ECM E16 (view with ECM cover removed)
A. Coolant reservoir |
| 4. ABS actuator and electric unit (control unit)
E125 (without VDC)
E127 (with VDC) | 5. Oil pressure switch E208 (with VQ40DE)
A. Oil pan (upper) | 6. Oil pressure switch F4 (with QR25DE) (view with engine removed) |
| 7. A/T assembly F9 | 8. BCM M18, M19 (view with lower instrument panel LH removed) | |

ENGINE COOLANT TEMPERATURE GAUGE : Component Description

INFOID:000000004056890

Unit	Description
Combination meter	Indicates the engine coolant temperature according to the engine coolant temperature signal received from ECM via CAN communication.
ECM	Transmits the engine coolant temperature signal to the combination meter via CAN communication.

FUEL GAUGE

METER SYSTEM

< FUNCTION DIAGNOSIS >

FUEL GAUGE : System Diagram

INFOID:000000004056891

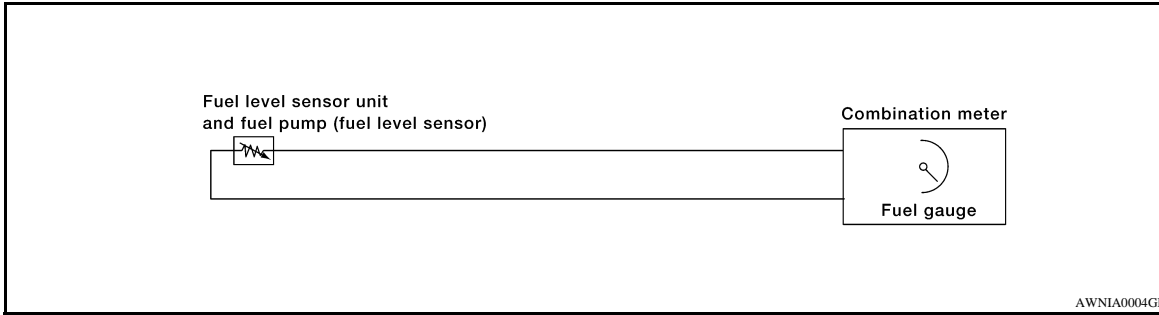

FUEL GAUGE : System Description

INFOID:000000004056892

The fuel gauge indicates the approximate fuel level in the fuel tank. The fuel gauge is regulated by the unified meter control unit and a variable resistor signal supplied by the fuel level sensor unit.

FUEL GAUGE : Component Parts Location

INFOID:000000004459289

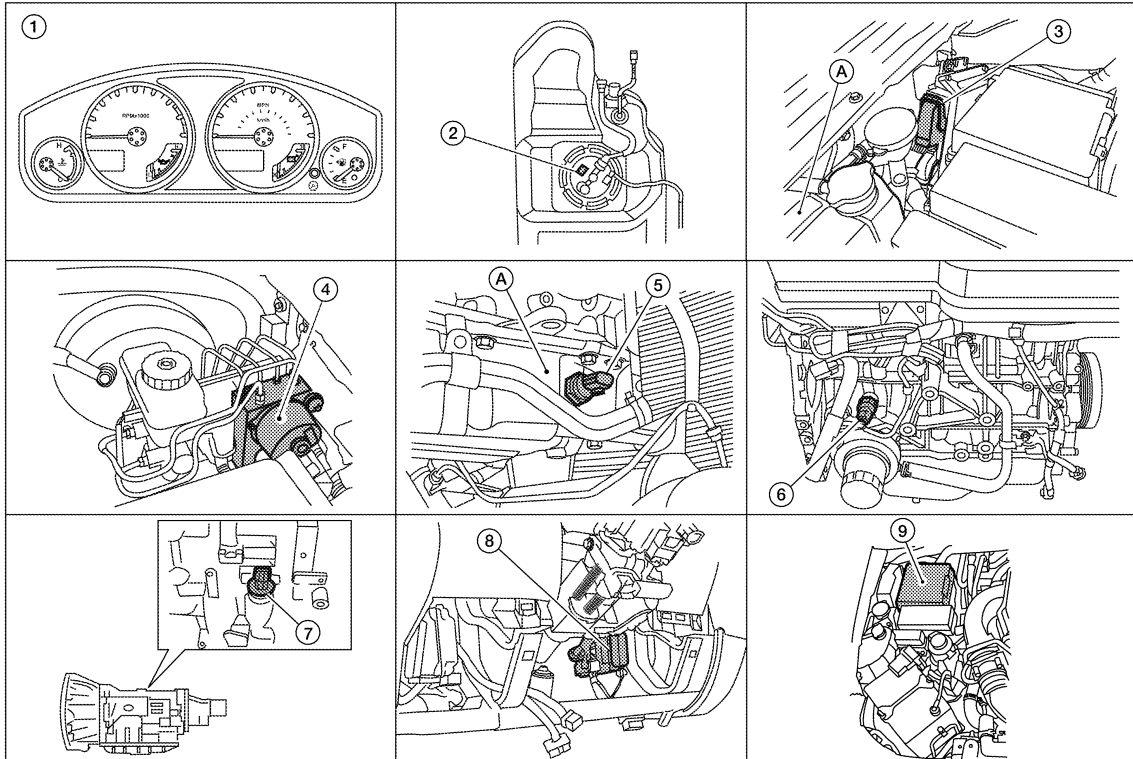

- | | | |
|---|--|--|
| 1. Combination meter M24 | 2. Fuel level sensor unit and fuel pump C5 (view with fuel tank removed) | 3. ECM E16 (view with ECM cover removed)
A. Coolant reservoir |
| 4. ABS actuator and electric unit (control unit)
E125 (without VDC)
E127 (with VDC) | 5. Oil pressure switch E208 (with VQ40DE)
A. Oil pan (upper) | 6. Oil pressure switch F4 (with QR25DE) (view with engine removed) |
| 7. A/T assembly F9 | 8. BCM M18, M19 (view with lower instrument panel LH removed) | |

METER SYSTEM

< FUNCTION DIAGNOSIS >

FUEL GAUGE : Component Description

INFOID:000000004056894

Unit	Description
Combination meter	Indicates the fuel level according to the fuel level sensor signal received from the fuel level sensor unit.
Fuel level sensor unit	Refer to MWI-32, "Description" .

ENGINE OIL PRESSURE GAUGE

ENGINE OIL PRESSURE GAUGE : System Diagram

INFOID:000000004056895

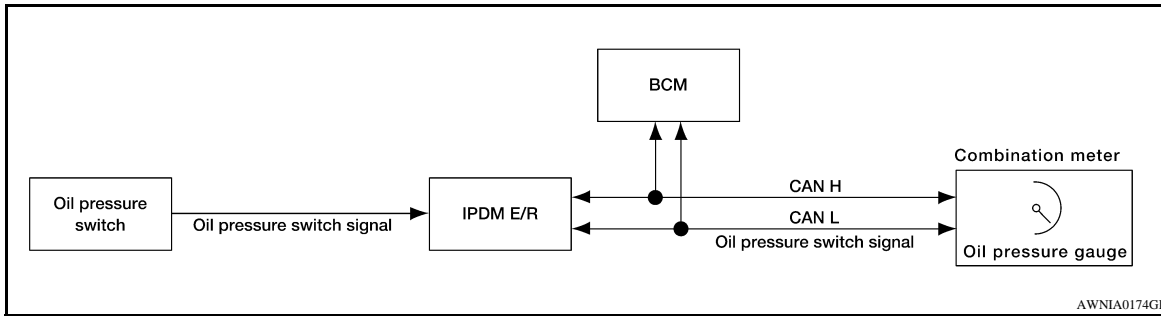

AWNIA0174GE

ENGINE OIL PRESSURE GAUGE : System Description

INFOID:000000004056896

The engine oil pressure gauge indicates whether the engine oil pressure is low or normal. The oil pressure gauge is controlled by the IPDM E/R. The IPDM E/R reads the ON/OFF signals from the oil pressure switch and transmits the oil pressure switch signal to the combination meter via BCM with the CAN communication line. The oil pressure gauge displays a low or normal indication according to the oil pressure switch signal received via CAN communication.

ENGINE OIL PRESSURE GAUGE : Component Parts Location

INFOID:000000004459290

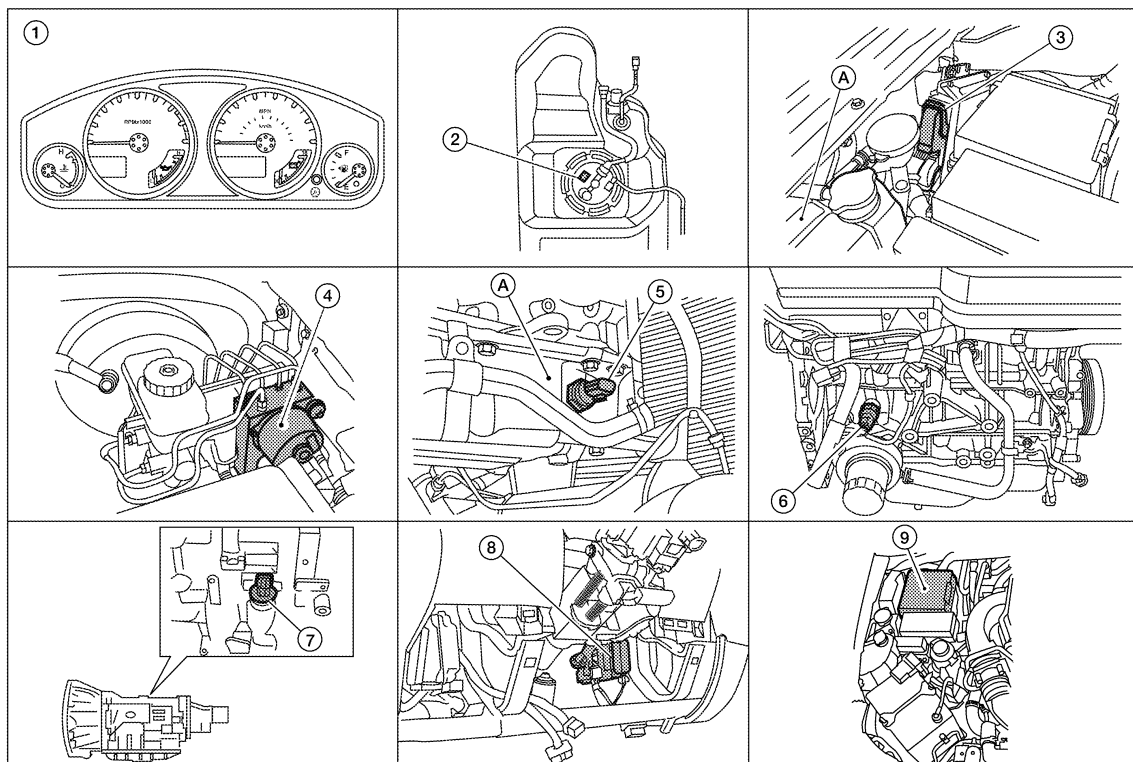

AWNIA0781ZZ

METER SYSTEM

< FUNCTION DIAGNOSIS >

- | | | | |
|---|--|--|---|
| 1. Combination meter M24 | 2. Fuel level sensor unit and fuel pump C5 (view with fuel tank removed) | 3. ECM E16 (view with ECM cover removed)
A. Coolant reservoir | A |
| 4. ABS actuator and electric unit (control unit)
E125 (without VDC)
E127 (with VDC) | 5. Oil pressure switch E208 (with VQ40DE)
A. Oil pan (upper) | 6. Oil pressure switch F4 (with QR25DE) (view with engine removed) | B |
| 7. A/T assembly F9 | 8. BCM M18, M19 (view with lower instrument panel LH removed) | | C |

ENGINE OIL PRESSURE GAUGE : Component Description

INFOID:000000004056898

Unit	Description
Combination meter	Indicates the engine oil pressure (low/normal) according to the oil pressure switch signal received from BCM with CAN communication line.
IPDM E/R	Reads the ON/OFF signals from the oil pressure switch and transmits the oil pressure switch signal to the combination meter via BCM with the CAN communication line.
Oil pressure switch	Refer to MWI-34, "Description" .
BCM	Transmits the oil pressure switch signal received from IPDM E/R via CAN communication to the combination meter via CAN communication.

VOLTAGE GAUGE

VOLTAGE GAUGE : System Diagram

INFOID:000000004056899

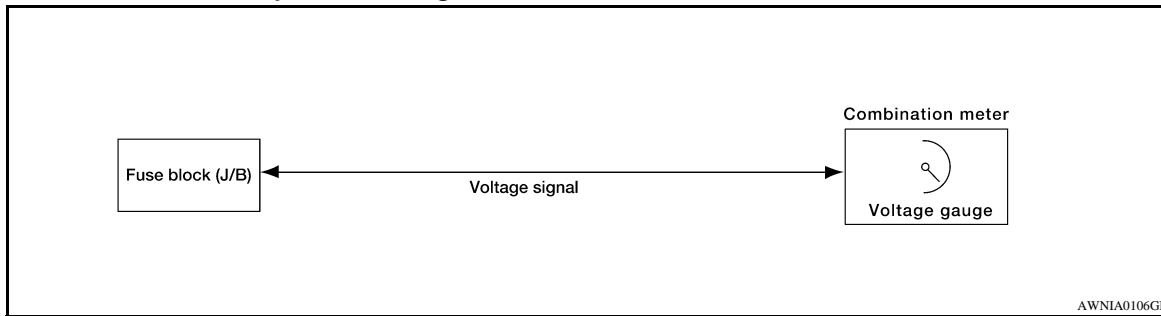

AWNIA0106GE

VOLTAGE GAUGE : System Description

INFOID:000000004056900

The voltage gauge indicates the battery/charging system voltage. The voltage gauge is regulated by the unified meter control unit.

METER SYSTEM

< FUNCTION DIAGNOSIS >

VOLTAGE GAUGE : Component Parts Location

INFOID:000000004459291

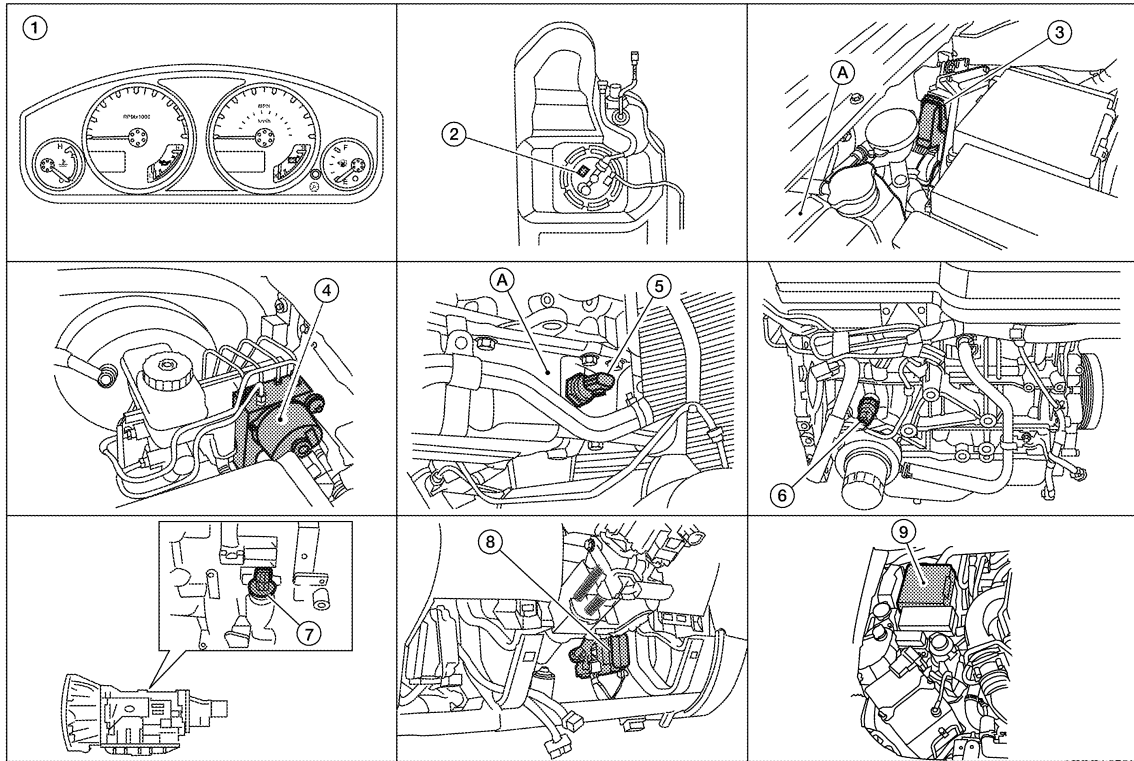

AWNLA0781ZZ

- | | | |
|---|--|--|
| 1. Combination meter M24 | 2. Fuel level sensor unit and fuel pump C5 (view with fuel tank removed) | 3. ECM E16 (view with ECM cover removed)
A. Coolant reservoir |
| 4. ABS actuator and electric unit (control unit)
E125 (without VDC)
E127 (with VDC) | 5. Oil pressure switch E208 (with VQ40DE)
A. Oil pan (upper) | 6. Oil pressure switch F4 (with QR25DE) (view with engine removed) |
| 7. A/T assembly F9 | 8. BCM M18, M19 (view with lower instrument panel LH removed) | |

VOLTAGE GAUGE : Component Description

INFOID:000000004056902

Unit	Description
Combination meter	Indicates the battery voltage according to the voltage signal received from the fuse block (J/B).
Fuse block (J/B)	Transmits the battery voltage signal to the combination meter.

ODO/TRIP METER

ODO/TRIP METER : System Diagram

INFOID:000000004056903

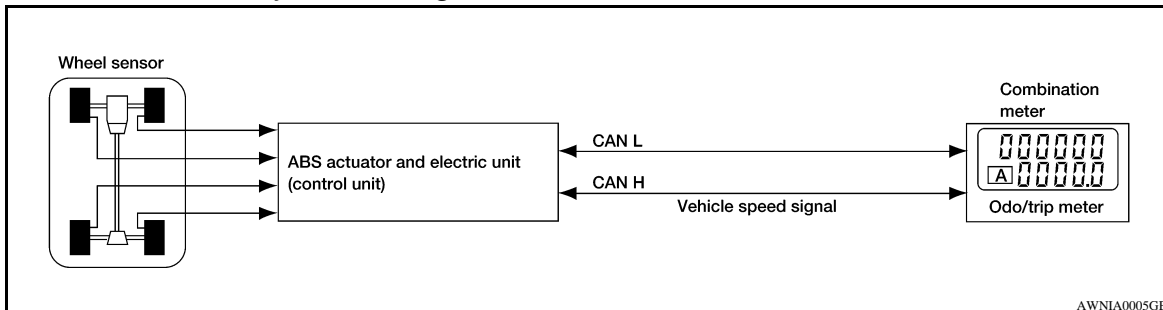

AWNLA0005GB

METER SYSTEM

< FUNCTION DIAGNOSIS >

ODO/TRIP METER : System Description

INFOID:000000004056904

The vehicle speed signal and the memory signals from the meter memory circuit are processed by the combination meter and the mileage is displayed.

HOW TO CHANGE THE DISPLAY FOR ODO/TRIP METER

Refer to Owner's Manual for odo/trip meter operating instructions.

ODO/TRIP METER : Component Parts Location

INFOID:000000004459292

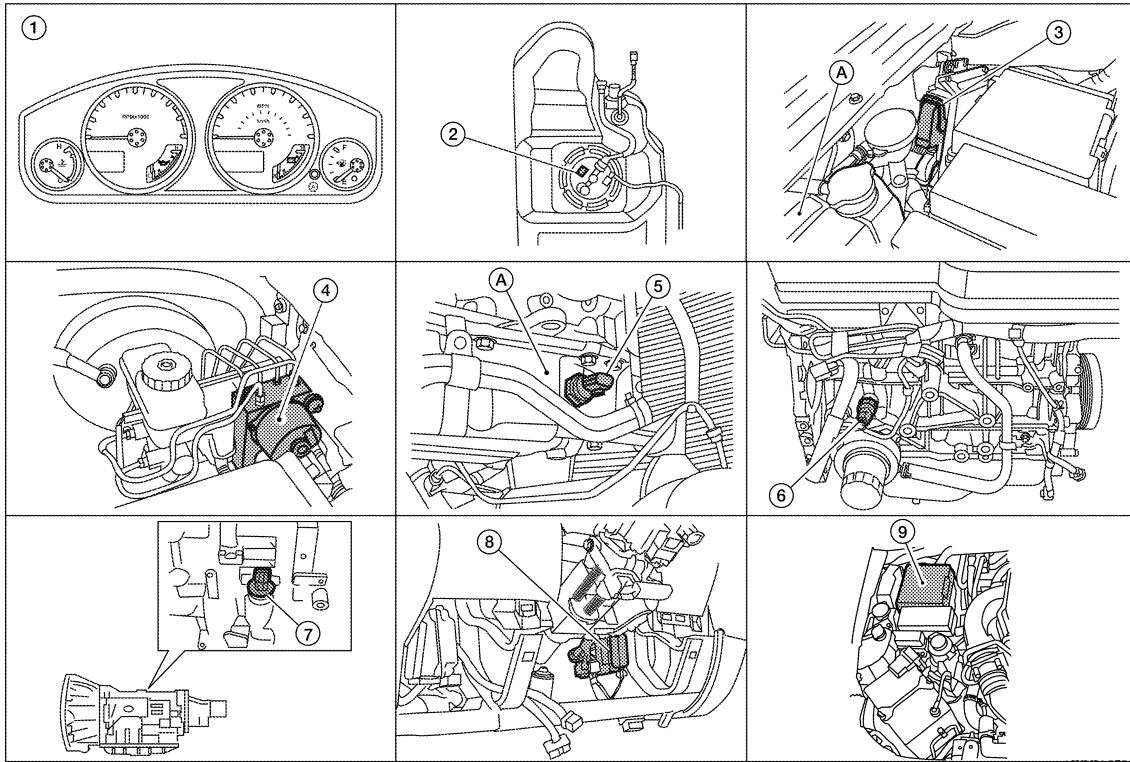

- | | | |
|---|--|--|
| 1. Combination meter M24 | 2. Fuel level sensor unit and fuel pump C5 (view with fuel tank removed) | 3. ECM E16 (view with ECM cover removed)
A. Coolant reservoir |
| 4. ABS actuator and electric unit (control unit)
E125 (without VDC)
E127 (with VDC) | 5. Oil pressure switch E208 (with VQ40DE)
A. Oil pan (upper) | 6. Oil pressure switch F4 (with QR25DE) (view with engine removed) |
| 7. A/T assembly F9 | 8. BCM M18, M19 (view with lower instrument panel LH removed) | |

ODO/TRIP METER : Component Description

INFOID:000000004056906

Unit	Description
Combination meter	Converts the vehicle speed signal received from the ABS actuator and electric unit (control unit) via CAN communication to mileage, and it displays the accumulated mileage to the odo/trip meter.
ABS actuator and electric unit (control unit)	Transmits the vehicle speed signal to the combination meter via CAN communication.

SHIFT POSITION INDICATOR

A
B
C
D
E
F
G
H
I
J
K
L
M
N
O
P

METER SYSTEM

< FUNCTION DIAGNOSIS >

SHIFT POSITION INDICATOR : System Diagram

INFOID:000000004056907

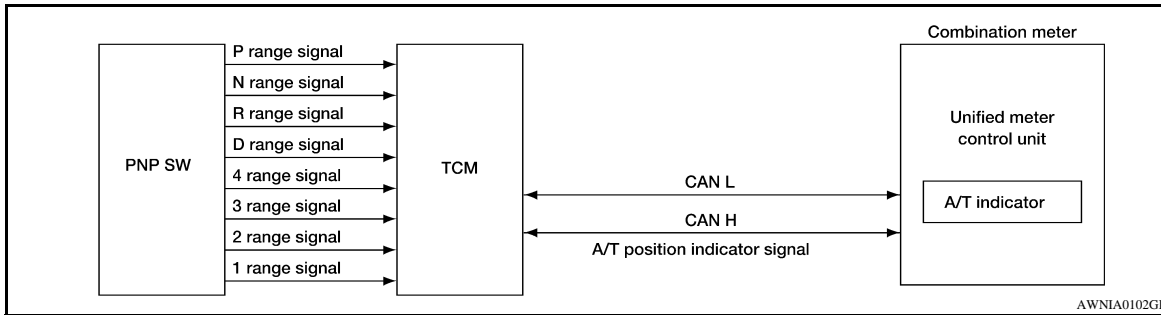

SHIFT POSITION INDICATOR : System Description

INFOID:000000004056908

The TCM receives A/T indicator signals from the park/neutral position (PNP) switch. The TCM then sends A/T position indicator signals to the combination meter via CAN communication lines. The combination meter indicates the received shift position.

SHIFT POSITION INDICATOR : Component Parts Location

INFOID:000000004459293

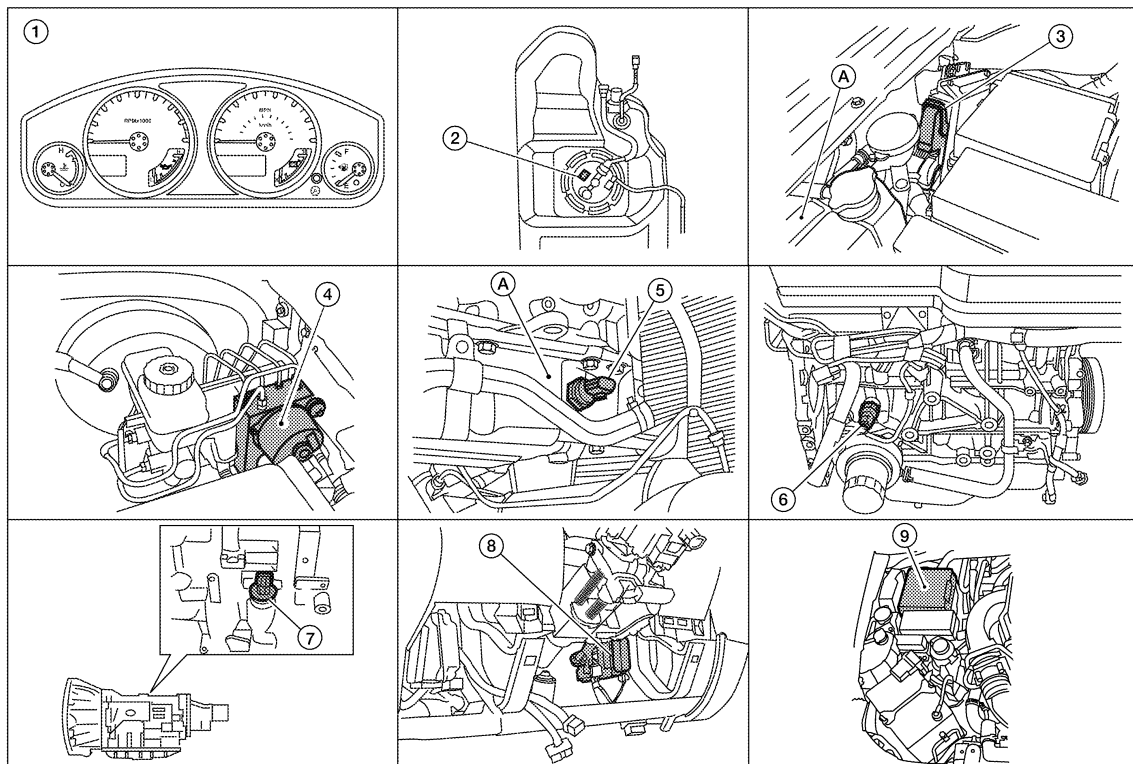

AWNIA0781ZZ

- | | | |
|---|--|--|
| 1. Combination meter M24 | 2. Fuel level sensor unit and fuel pump C5 (view with fuel tank removed) | 3. ECM E16 (view with ECM cover removed)
A. Coolant reservoir |
| 4. ABS actuator and electric unit (control unit)
E125 (without VDC)
E127 (with VDC) | 5. Oil pressure switch E208 (with VQ40DE)
A. Oil pan (upper) | 6. Oil pressure switch F4 (with QR25DE) (view with engine removed) |
| 7. A/T assembly F9 | 8. BCM M18, M19 (view with lower instrument panel LH removed) | |

METER SYSTEM

< FUNCTION DIAGNOSIS >

SHIFT POSITION INDICATOR : Component Description

INFOID:000000004056910

Unit	Description
Combination meter	Displays the shift position using shift position signal received from TCM.
TCM	Transmits the shift position signal to the combination meter via CAN communication.

WARNING LAMPS/INDICATOR LAMPS

WARNING LAMPS/INDICATOR LAMPS : System Diagram

INFOID:000000004056911

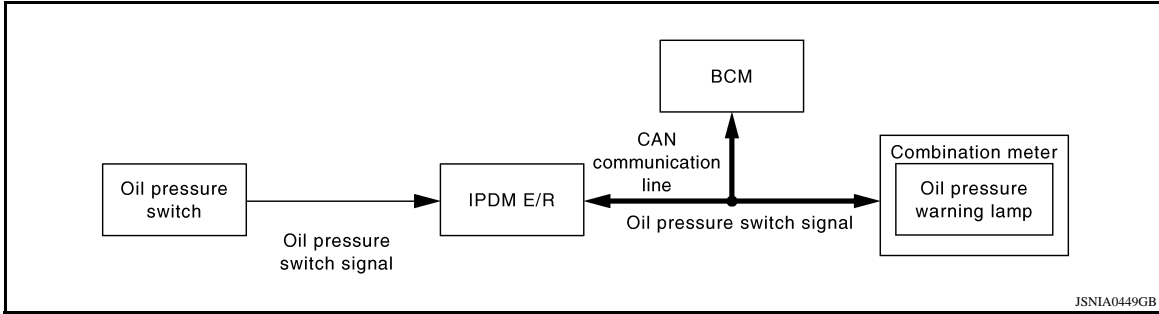

WARNING LAMPS/INDICATOR LAMPS : System Description

INFOID:000000004056912

OIL PRESSURE WARNING LAMP

- IPDM E/R reads the ON/OFF signals from the oil pressure switch and transmits the oil pressure switch signal to the combination meter via BCM with the CAN communication line.
- The combination meter turns the oil pressure warning lamp ON/OFF according to the oil pressure switch signal received via CAN communication.

WARNING LAMPS/INDICATOR LAMPS : Component Parts Location

INFOID:000000004459294

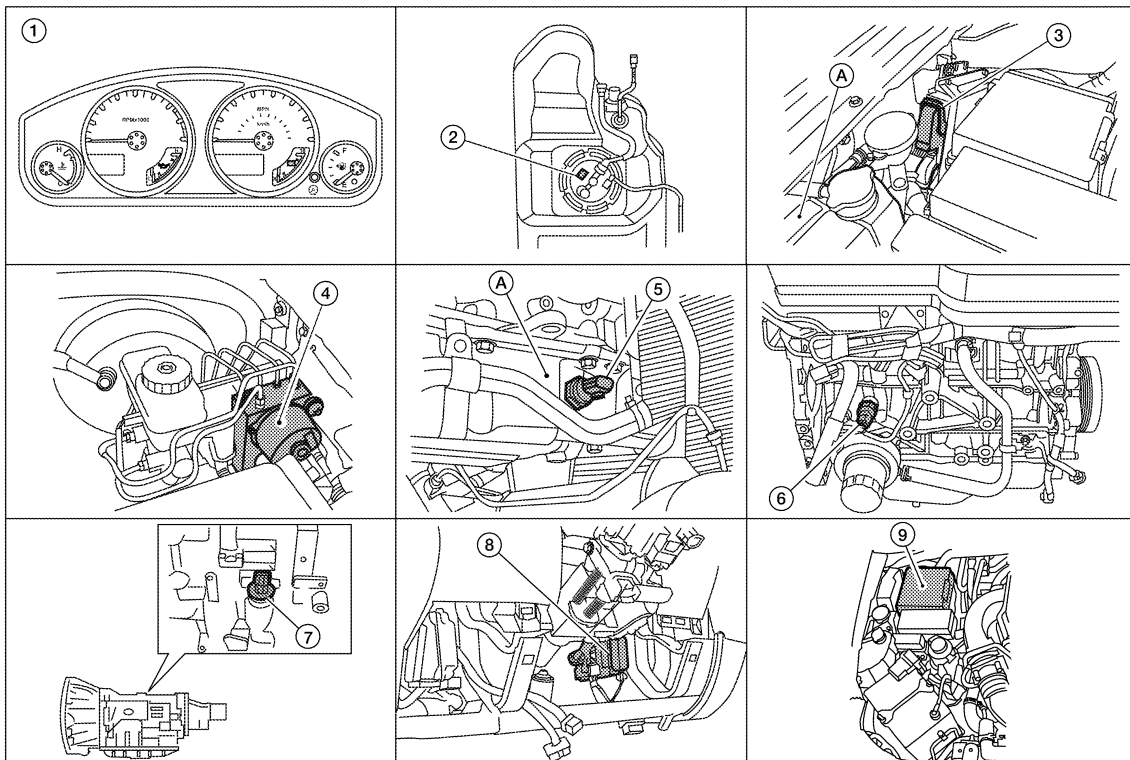

AWNIA0781ZZ

METER SYSTEM

< FUNCTION DIAGNOSIS >

- | | | |
|---|--|--|
| 1. Combination meter M24 | 2. Fuel level sensor unit and fuel pump C5 (view with fuel tank removed) | 3. ECM E16 (view with ECM cover removed)
A. Coolant reservoir |
| 4. ABS actuator and electric unit (control unit)
E125 (without VDC)
E127 (with VDC) | 5. Oil pressure switch E208 (with VQ40DE)
A. Oil pan (upper) | 6. Oil pressure switch F4 (with QR25DE) (view with engine removed) |
| 7. A/T assembly F9 | 8. BCM M18, M19 (view with lower instrument panel LH removed) | |

WARNING LAMPS/INDICATOR LAMPS : Component Description

INFOID:000000004056914

Unit	Description
Combination meter	Turns the oil pressure warning lamp ON/OFF according to the oil pressure switch signal received from BCM by means of communication.
IPDM E/R	Reads the ON/OFF signals from the oil pressure switch and transmits the oil pressure switch signal to the combination meter via BCM with the CAN communication line.
Oil pressure switch	Refer to MWI-34, "Description" .
BCM	Transmits the oil pressure switch signal received from IPDM E/R via CAN communication to the combination meter via CAN communication.

TRIP COMPUTER

TRIP COMPUTER : System Diagram

INFOID:000000004056915

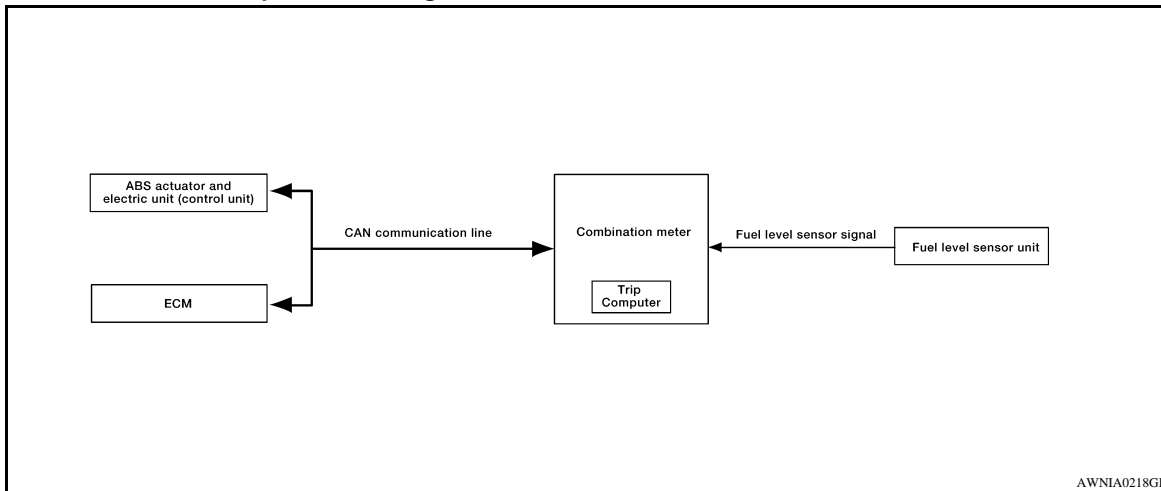

TRIP COMPUTER : System Description

INFOID:000000004056916

FUNCTION

The trip computer can indicate the following items.

- DTE (distance to empty)
- Trip distance
- Trip time
- Average fuel consumption
- Average vehicle speed

DTE (DISTANCE TO EMPTY) INDICATION

The range indication provides the driver with an estimation of the distance that can be driven before refueling. The range is calculated by signals from the fuel level sensor unit (fuel remaining), ECM (fuel consumption) and the ABS actuator and electric unit (vehicle speed). The indication will be refreshed every 30 seconds. When fuel remaining is less than approximately 11.6 ℓ (3 1/8 US gal, 2 1/2 Imp gal), the indication will blink as a warning. If the fuel remaining is less than approximately 9.6 ℓ (2 1/2 US gal, 2 1/8 Imp gal), the indication will show “---”. In this case, the display will change to the DTE mode even though the display is showing a different

METER SYSTEM

< FUNCTION DIAGNOSIS >

mode. When the battery is disconnected and reconnected, DTE mode will display “---” until the vehicle is driven 0.3 miles (0.5 km).

TRIP DISTANCE

Trip distance is calculated by signal from the ABS actuator and electric unit (vehicle speed). If trip distance is reset, trip time will be reset at the same time.

TRIP TIME

Trip time displays cumulative ignition switch ON time. If trip time is reset, trip distance will be reset at the same time.

AVERAGE FUEL CONSUMPTION

Average fuel consumption indication is calculated by signals from the ABS actuator and electric unit (vehicle speed) and the ECM (fuel consumption). The indication will be refreshed every 30 seconds.

AVERAGE VEHICLE SPEED

Average vehicle speed indication is calculated by running distance and running time. The indication will be refreshed every 30 seconds. If average vehicle speed is reset, average fuel consumption will be reset at the same time. After resetting, the display will show “---” for 30 seconds.

HOW TO CHANGE/RESET INDICATION

Refer to Owner's Manual for trip computer operating instructions.

TRIP COMPUTER : Component Parts Location

INFOID:000000004459295

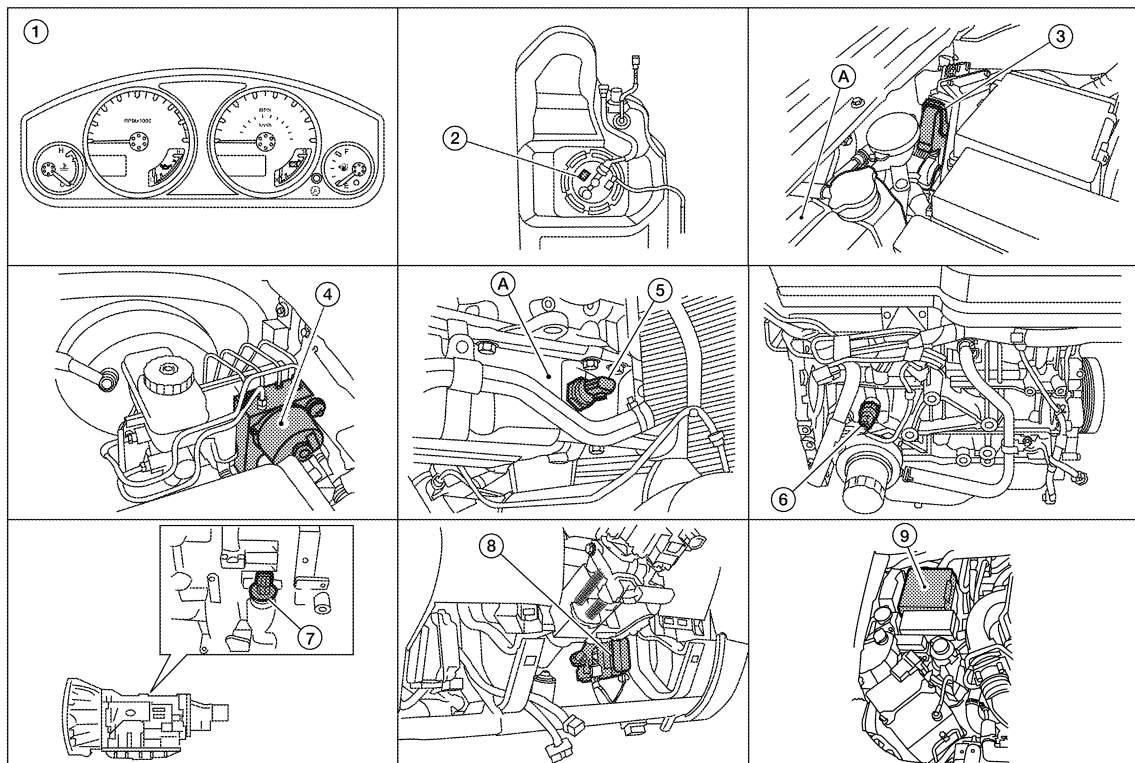

- | | | |
|---|--|--|
| 1. Combination meter M24 | 2. Fuel level sensor unit and fuel pump C5 (view with fuel tank removed) | 3. ECM E16 (view with ECM cover removed)
A. Coolant reservoir |
| 4. ABS actuator and electric unit (control unit)
E125 (without VDC)
E127 (with VDC) | 5. Oil pressure switch E208 (with VQ40DE)
A. Oil pan (upper) | 6. Oil pressure switch F4 (with QR25DE) (view with engine removed) |
| 7. A/T assembly F9 | 8. BCM M18, M19 (view with lower instrument panel LH removed) | |

METER SYSTEM

< FUNCTION DIAGNOSIS >

TRIP COMPUTER : Component Description

INFOID:000000004056918

Unit	Description
Combination meter	Controls the information display according to the signal received from each unit.
Fuel level sensor unit	Refer to MWI-32 , "Description".
ECM	Transmits the following signals to the combination meter via CAN communication line. <ul style="list-style-type: none">• Engine speed signal• Fuel consumption monitor signal
ABS actuator and electric unit (control unit)	Transmits the vehicle speed signal to the combination meter via CAN communication line.

COMPASS

< FUNCTION DIAGNOSIS >

COMPASS

Description

INFOID:000000004056919

DESCRIPTION

With the ignition switch in the ON position, and the mode (N) switch ON, the compass display will indicate the direction the vehicle is heading.

Vehicle direction is displayed as follows:

- N: north
- E: east
- S: south
- W: west

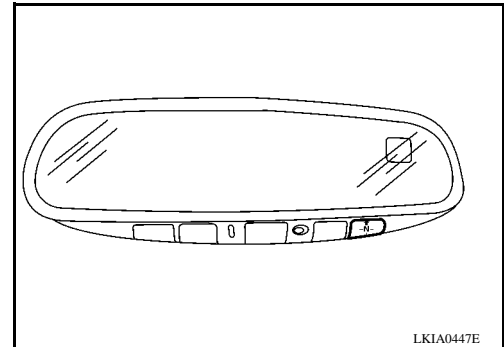

ZONE VARIATION SETTING PROCEDURE

The difference between magnetic north and geographical north can sometimes be great enough to cause false compass readings. This difference is known as variance. In order for the compass to operate properly (accurately) in a particular zone, the zone variation must be calibrated using the following procedure.

Zone Variation Chart

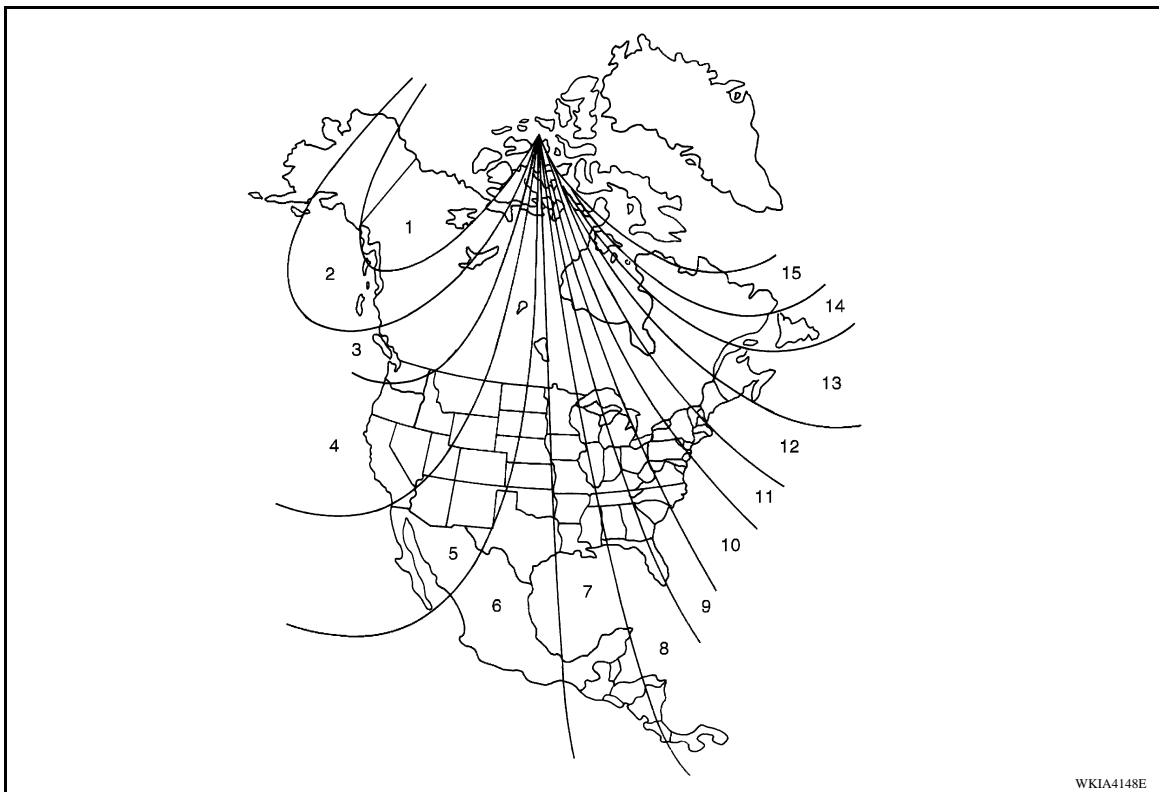

1. Determine your location on the zone map.
2. Turn the ignition switch to the ON position.
3. Press and hold the mode (N) switch for about 8 seconds. The current zone number will appear in the display.
4. Press the mode (N) switch repeatedly until the desired zone number appears in the display.

Once the desired zone number is displayed, stop pressing the mode (N) switch and the display will show a compass direction after a few seconds.

NOTE:

Use zone number 5 for Hawaii.

CALIBRATION PROCEDURE

A
B
C
D
E
F
G
H
I
J
K
L
M
N
O
P

COMPASS

< FUNCTION DIAGNOSIS >

The compass display is equipped with an automatic correction function. If the compass display reads "CAL" or the direction is not shown correctly, perform the correction procedure below.

1. Press and hold the mode (N) switch for about 10 seconds. The display will read "CAL".
2. Drive the vehicle slowly in a circle, in an open, safe place. The initial calibration is completed in about 3 turns.

NOTE:

In places where the terrestrial magnetism is extremely disturbed, the initial correction may start automatically.

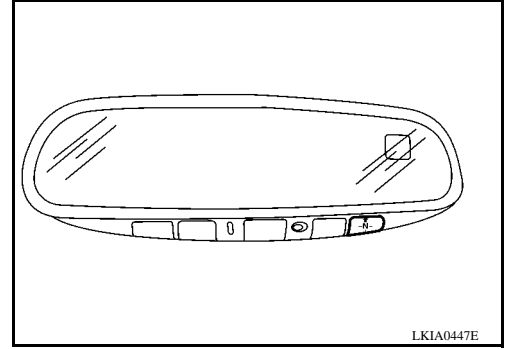

DIAGNOSIS SYSTEM (METER)

< FUNCTION DIAGNOSIS >

DIAGNOSIS SYSTEM (METER)

Diagnosis Description

INFOID:000000004056920

SELF-DIAGNOSIS MODE

The following items can be checked during Combination Meter Self-Diagnosis Mode.

- Gauge sweep and present gauge values.
- Illuminates all odometer/trip meters and A/T indicator segments.
- Illuminates all micro controlled lamps/LEDs regardless of switch position.
- Displays estimated present battery voltage.
- Displays seat belt buckle switch LH status.

OPERATION PROCEDURE

NOTE:

- Once entered, combination meter self-diagnosis mode will function with the ignition switch in ON or START. Combination meter self-diagnosis mode will exit upon turning the ignition switch to OFF or ACC.
- If the diagnosis function is activated with trip A displayed, the mileage on trip A is reset to 0000.0. (Trip B operates the same way.)

To initiate combination meter self-diagnosis mode, refer to the following procedure.

1. Turn the ignition switch ON, while pressing the odometer/trip meter switch for 5 - 8 seconds. When the diagnosis function is activated, the odometer/trip meter will display tEst.

NOTE:

Check combination meter power supply and ground circuit when self-diagnosis mode of combination meter does not start. Refer to [MWI-29, "COMBINATION METER : Diagnosis Procedure"](#). Replace combination meter if normal. Refer to [MWI-93, "Removal and Installation"](#).

COMBINATION METER SELF-DIAGNOSIS MODE FUNCTIONS

To interpret combination meter self-diagnosis mode functions, refer to the following table.

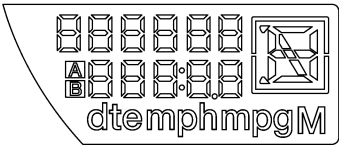
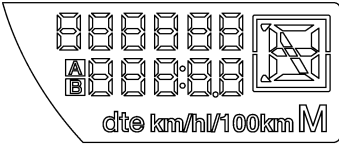
Event	Odometer Display	Description of Test/Data	Notes:
Odometer/trip meter A/B switch held from 5 to 8 seconds (or until released)	tEst		Initiating self-diagnosis mode
Switch released	GAGE	Performs sweep of all gauges, then displays present gauge values.	Gauges sweep within 10 seconds
Switch pressed	(All segments illuminated)	Lights all LCD segments. Compare with picture.	<p>USA</p>  <p>AWNIA0219ZZ</p> <p>Canada</p>  <p>AWNIA0220ZZ</p>
Switch pressed	bulb	Illuminates all micro-controlled lamps/LEDs.	Part may not be configured for all lamps (functions) that turn on during test. This is normal.
Switch pressed	r XXXX, FAIL	Return to normal operation of all lamps/LEDs and displays "r XXXX".	If a malfunction exists, "FAIL" will flash.

DIAGNOSIS SYSTEM (METER)

< FUNCTION DIAGNOSIS >

Event	Odometer Display	Description of Test/Data	Notes:
Switch pressed	nrXXXX	Displays Hex ROM rev as stored in NVM.	
Switch pressed	EE XX, FAIL	Displays "EE XX".	If a malfunction exists, "FAIL" will flash.
Switch pressed	dtXXXX	Hex coding of final manufacturing test date.	
Switch pressed (3 times)	Sc1 XX through Epr XX	Displays 8 bit software configuration value in Hex format	
Switch pressed	1nF XX	Displays 8-bit market info value in Hex format.	\$31 = USA \$2A = Canada
Switch pressed (3 times)	cYL XX through tF	N/A	
Switch pressed	ot1 XX	Displays oil pressure tell-tale "" in Hex format.	
Switch pressed	ot0 XX	Displays oil pressure tell-tale "" in Hex format.	
Switch pressed	XXXXX	"Corrected" speed value in hundredths of MPH. Gauge indication may be slightly higher. This is normal.	Will display "----" if message is not received. Will display "99999" if data received is invalid.
Switch pressed	XXXXX	"Corrected" speed value in hundredths of KPH. Gauge indication may be slightly different. This is normal.	Will display "----" if message is not received. Will display "99999" if data received is invalid.
Switch pressed	t XXXX	Tachometer value in RPM. Gauge indication may be higher at higher RPM. This is normal.	Will display "----" if message is not received.
Switch pressed	F1XXXX	Present fuel level A/D input. This input represents fuel sender input.	000-009 = Short circuit 010-254 = Normal range 255 = Open circuit
Switch pressed	XXXXC	Last temperature gauge input value in degrees C. Temperature gauge indicates present temperature per indication standard.	Will display "---"C if message is not received. Will display "999" if data received is invalid. High = 130 deg C Normal = 70 - 105 deg C Low = less than 50 deg C
Switch pressed	BAtXX.X	Estimated present battery voltage.	
Switch pressed	rES -X	Seat belt buckle switch LH status.	1 = Buckled 0 = Unbuckled
Switch pressed (30 times)	PA -XX through PA1-XX	N/A	
Switch pressed	GAGE		Return to beginning of self-diagnosis cycle.

CONSULT-III Function (METER/M&A)

INFOID:000000004056921

CONSULT-III can display each diagnostic item using the diagnostic test modes shown following.

DIAGNOSIS SYSTEM (METER)

< FUNCTION DIAGNOSIS >

METER/M&A diagnosis mode	Description
SELF-DIAG RESULTS	Displays combination meter self-diagnosis results.
DATA MONITOR	Displays combination meter input/output data in real time.
CAN DIAG SUPPORT MNTR	The result of transmit/receive diagnosis of CAN communication can be read.

SELF-DIAG RESULTS

Display Item List

Refer to [MWI-58, "DTC Index"](#).

DATA MONITOR

Display Item List

X: Applicable

Display item [Unit]	MAIN SIGNALS	SELECTION FROM MENU	Description
SPEED METER [km/h] or [mph]	X	X	Displays the value of vehicle speed signal.
SPEED OUTPUT [km/h] or [mph]	X	X	Displays the value of vehicle speed signal, which is transmitted to each unit with CAN communication.
TACHO METER [rpm]	X	X	Displays the value of engine speed signal, which is input from ECM.
FUEL METER [lit.]	X	X	Displays the value, which processes a resistance signal from fuel gauge.
W TEMP METER [°C] or [°F]	X	X	Displays the value of engine coolant temperature signal, which is input from ECM.
ABS W/L [ON/OFF]		X	Displays [ON/OFF] condition of ABS warning lamp.
VDC/TCS IND [ON/OFF]		X	Displays [ON/OFF] condition of VDC OFF indicator lamp.
SLIP IND [ON/OFF]		X	Displays [ON/OFF] condition of SLIP indicator lamp.
BRAKE W/L [ON/OFF]		X	Displays [ON/OFF] condition of brake warning lamp.*
DOOR W/L [ON/OFF]		X	Displays [ON/OFF] condition of door warning lamp.
HI-BEAM IND [ON/OFF]		X	Displays [ON/OFF] condition of high beam indicator.
TURN IND [ON/OFF]		X	Displays [ON/OFF] condition of turn indicator.
OIL W/L [ON/OFF]		X	Displays [ON/OFF] condition of oil pressure warning lamp.
C-ENG W/L [ON/OFF]		X	Displays [ON/OFF] condition of malfunction indicator lamp.
CRUISE IND [ON/OFF]		X	Displays [ON/OFF] condition of CRUISE indicator.
SET IND [ON/OFF]		X	Displays [ON/OFF] condition of SET indicator.
O/D OFF W/L [ON/OFF]		X	Displays [ON/OFF] condition of AT CHECK (with manual mode) or O/D OFF (without manual mode) warning lamp.
FUEL W/L [ON/OFF]	X	X	Displays [ON/OFF] condition of low-fuel warning lamp.
AIR PRES W/L [ON/OFF]		X	Displays [ON/OFF] condition of tire pressure warning lamp.
KEY G/Y W/L [ON/OFF]		X	This item is not used for this model. "OFF" is always displayed.
KEY R W/L [ON/OFF]		X	
KEY KNOB W/L [ON/OFF]		X	
M RANGE SW [ON/OFF]	X	X	Displays [ON/OFF] condition of manual mode range switch.
NM RANGE SW [ON/OFF]	X	X	Displays [ON/OFF] condition of except for manual mode range switch.
AT SFT UP SW [ON/OFF]	X	X	Displays [ON/OFF] condition of A/T shift-up switch.
AT SFT DWN SW [ON/OFF]	X	X	Displays [ON/OFF] condition of A/T shift-down switch.
DISTANCE [km] or [mile]	X	X	Displays the value, which is calculated by vehicle speed signal, fuel gauge and fuel consumption from ECM.
BUZZER [ON/OFF]	X	X	Displays [ON/OFF] condition of buzzer.
BRAKE SW [ON/OFF]		X	Indicates [ON/OFF] condition of parking brake switch.

DIAGNOSIS SYSTEM (METER)

< FUNCTION DIAGNOSIS >

Display item [Unit]	MAIN SIGNALS	SELECTION FROM MENU	Description
AT-M IND [ON/OFF]	X	X	Indicates [ON/OFF] condition of A/T manual mode indicator.
AT-M GEAR [1, 2, 3, 4, 5]	X	X	Indicates [1, 2, 3, 4, 5] condition of A/T manual mode gear position.
P RANGE IND [ON/OFF]	X	X	Indicates [ON/OFF] condition of A/T shift P range indicator.
R RANGE IND [ON/OFF]	X	X	Indicates [ON/OFF] condition of A/T shift R range indicator.
N RANGE IND [ON/OFF]	X	X	Indicates [ON/OFF] condition of A/T shift N range indicator.
D RANGE IND [ON/OFF]	X	X	Indicates [ON/OFF] condition of A/T shift D range indicator.
4 RANGE IND [ON/OFF]	X	X	Indicates [ON/OFF] condition of A/T shift 4 range indicator.
3 RANGE IND [ON/OFF]	X	X	Indicates [ON/OFF] condition of A/T shift 3 range indicator.
2 RANGE IND [ON/OFF]	X	X	Indicates [ON/OFF] condition of A/T shift 2 range indicator.
1 RANGE IND [ON/OFF]	X	X	Indicates [ON/OFF] condition of A/T shift 1 range indicator.
4WD LOCK SW [ON/OFF]		X	Indicates [ON/OFF] condition of 4WD lock switch.
4WD LOCK IND [ON/OFF]		X	Indicates [ON/OFF] condition of 4WD lock indicator.
SEAT BELT W/L [ON/OFF]		X	Indicates [ON/OFF] condition of seat belt warning lamp.
O/D OFF SWITCH [ON/OFF]		X	Indicates [ON/OFF] condition of O/D OFF switch.
FR FOG IND [ON/OFF]		X	This item is not used for this model. "OFF" is always displayed.
RR FOG IND [ON/OFF]		X	

NOTE:

Some items are not available due to vehicle specification.

*: The monitor will indicate "OFF" even though the brake warning lamp is on if either of the following conditions exist.

- The parking brake is engaged
- The brake fluid level is low

DTC U1000 CAN COMMUNICATION

< COMPONENT DIAGNOSIS >

COMPONENT DIAGNOSIS

DTC U1000 CAN COMMUNICATION

DTC Logic

INFOID:000000004056922

DTC DETECTION LOGIC

DTC	CONSULT-III display	Detection condition
U1000	CAN COMM CIRC [U1000]	When combination meter is not receiving CAN communication signals for 2 seconds or more.

Diagnosis Procedure

INFOID:000000004056923

Symptom: Displays "CAN COMM CIRC [U1000]" as a self-diagnosis result of combination meter.

1. CHECK CAN COMMUNICATION

Select "SELF-DIAG RESULTS" mode for "METER/M&A" with CONSULT-III.

>> Go to "LAN system". Refer to [LAN-14. "Trouble Diagnosis Flow Chart"](#).

A
B
C
D
E
F
G
H
I
J
K
L
M
O
P

MWI

DTC B2205 VEHICLE SPEED CIRCUIT

< COMPONENT DIAGNOSIS >

DTC B2205 VEHICLE SPEED CIRCUIT

Description

INFOID:000000004056924

The ABS actuator and electric unit (control unit) provides a vehicle speed signal to the combination meter via CAN communication lines.

DTC Logic

INFOID:000000004056925

DTC	CONSULT-III display	Detection condition
B2205	VEHICLE SPEED CIRC [B2205]	Malfunction is detected when an erroneous speed signal is received for 2 seconds or more.

Diagnosis Procedure

INFOID:000000004056926

Symptom: Displays "VEHICLE SPEED CIRC [B2205]" as a self-diagnosis result of combination meter.

1. CHECK COMBINATION METER INPUT SIGNAL

1. Start engine and select "METER/M&A" on CONSULT-III.
2. Using "SPEED METER" on "DATA MONITOR", compare the value of DATA MONITOR with speedometer pointer of combination meter. Speedometer and DATA MONITOR indications should be close.

Is the inspection result normal?

- YES >> Perform ABS actuator and electric unit (control unit) self-diagnosis. Refer to [BRC-20, "CONSULT-III Function \(ABS\)"](#) (TYPE 1), [BRC-86, "CONSULT-III Function \(ABS\)"](#) (TYPE 2) or [BRC-182, "CONSULT-III Function \(ABS\)"](#) (TYPE 3).
- NO >> Replace combination meter. Refer to [MWI-93, "Removal and Installation"](#).

POWER SUPPLY AND GROUND CIRCUIT

< COMPONENT DIAGNOSIS >

POWER SUPPLY AND GROUND CIRCUIT COMBINATION METER

COMBINATION METER : Diagnosis Procedure

INFOID:000000004056927

1. CHECK FUSES

Check for blown combination meter fuses.

Unit	Power source	Fuse No.
Combination meter	Battery	19
	Ignition switch ON or START	14

Is the inspection result normal?

YES >> GO TO 2

NO >> If fuse is blown, be sure to eliminate cause of malfunction before installing new fuse.

2. POWER SUPPLY CIRCUIT CHECK

1. Disconnect combination meter connector M24.
2. Check voltage between combination meter harness connector M24 terminals 3, 16 and ground.

Terminals		(-)	Ignition switch position		
(+)			OFF	ACC	ON
Connector	Terminal	Ground	Battery voltage	Battery voltage	Battery voltage
M24	3		Ground	Battery voltage	Battery voltage
	16	0V		0V	Battery voltage

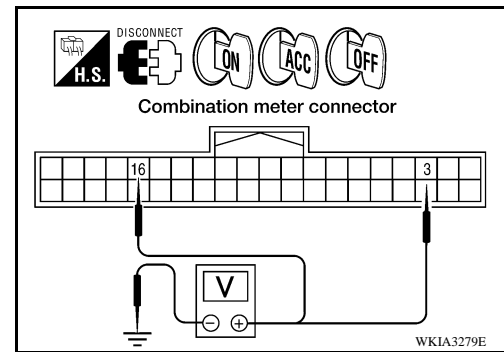

Is the inspection result normal?

YES >> GO TO 3

NO >> Check harness for open between combination meter and fuse.

3. GROUND CIRCUIT CHECK

1. Turn ignition switch OFF.
2. Check continuity between combination meter harness connector M24 terminals 13, 23 and ground.

Terminals		(-)	Continuity
(+)			
Connector	Terminal	Ground	Yes
M24	13		
	23		

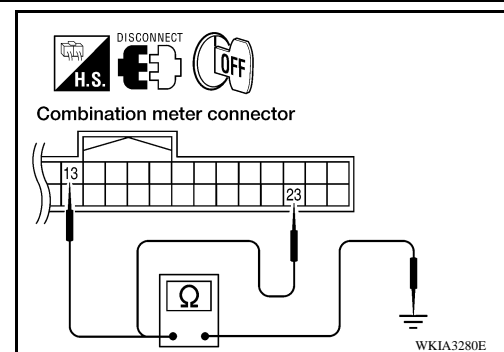

Is the inspection result normal?

YES >> Inspection End.

NO >> Check ground harness.

BCM (BODY CONTROL MODULE)

BCM (BODY CONTROL MODULE) : Diagnosis Procedure

INFOID:000000004056928

1. CHECK FUSES AND FUSIBLE LINK

Check that the following fuses and fusible link are not blown.

A
B
C
D
E
F
G
H
I
J
K
L
M
N
O
P

POWER SUPPLY AND GROUND CIRCUIT

< COMPONENT DIAGNOSIS >

Terminal No.	Signal name	Fuses and fusible link No.
57	Battery power supply	18 (10A)
70		G (50A)
11	Ignition ACC or ON	4 (10A)
38	Ignition ON or START	1 (10A)

Is the fuse blown?

- YES >> Replace the blown fuse or fusible link after repairing the affected circuit.
 NO >> GO TO 2

2. CHECK POWER SUPPLY CIRCUIT

1. Turn ignition switch OFF.
2. Disconnect BCM.
3. Check voltage between BCM harness connector and ground.

Connector	Terminals		Power source	Condition	Voltage (V) (Approx.)
	(+)	(-)			
M18	11	Ground	ACC power supply	Ignition switch ACC or ON	Battery voltage
	38	Ground	Ignition power supply	Ignition switch ON or START	Battery voltage
M20	57	Ground	Battery power supply	Ignition switch OFF	Battery voltage
	70	Ground	Battery power supply	Ignition switch OFF	Battery voltage

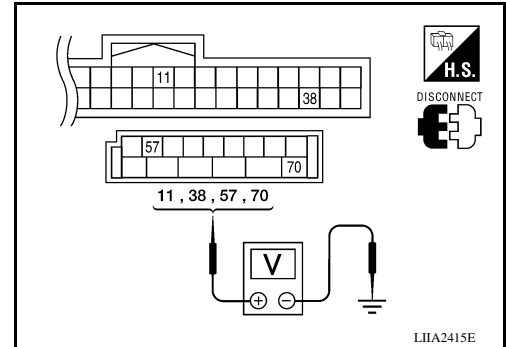

Is the measurement value normal?

- YES >> GO TO 3
 NO >> Repair or replace harness.

3. CHECK GROUND CIRCUIT

Check continuity between BCM harness connector and ground.

BCM		Ground	Continuity
Connector	Terminal		
M20	67		Yes

Does continuity exist?

- YES >> Inspection End.
 NO >> Repair or replace harness.

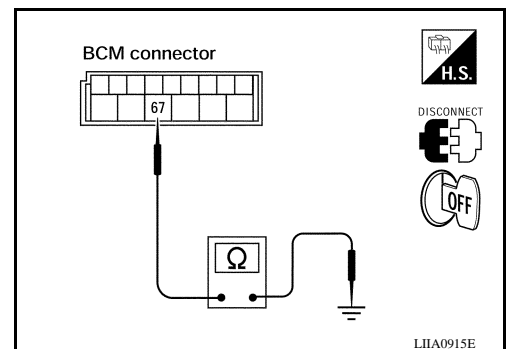

IPDM E/R (INTELLIGENT POWER DISTRIBUTION MODULE ENGINE ROOM)

IPDM E/R (INTELLIGENT POWER DISTRIBUTION MODULE ENGINE ROOM) : Diagnosis Procedure

INFOID:000000004056929

1. CHECK FUSES AND FUSIBLE LINK

Check that the following IPDM E/R fuses or fusible link are not blown.

POWER SUPPLY AND GROUND CIRCUIT

< COMPONENT DIAGNOSIS >

Terminal No.	Signal name	Fuses and fusible link No.
1	Battery	A, D
2	Battery	C

Is the fuse blown?

YES >> Replace the blown fuse or fusible link after repairing the affected circuit.

NO >> GO TO 2

2. CHECK BATTERY POWER SUPPLY CIRCUIT

1. Turn ignition switch OFF.
2. Disconnect IPDM E/R.
3. Check voltage between IPDM E/R harness connectors and ground.

Terminals		(-)	Ignition switch position		
(+)	Connector		Terminal	OFF	ON
E118 (A)	1	Ground	Battery voltage	Battery voltage	Battery voltage
	2		Battery voltage	Battery voltage	Battery voltage

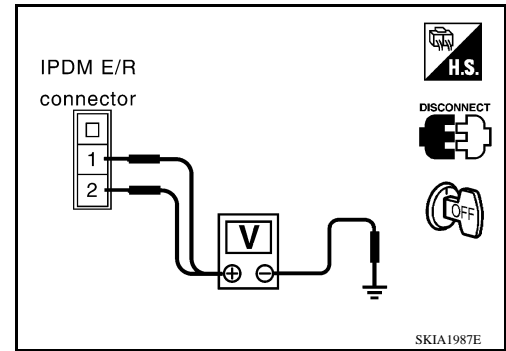

Is the measurement value normal?

YES >> GO TO 3

NO >> Repair or replace harness.

3. CHECK GROUND CIRCUIT

1. Turn ignition switch OFF.
2. Check continuity between IPDM E/R harness connectors and ground.

IPDM E/R		Ground	Continuity
Connector	Terminal		
E122 (A)	38		Yes
E124 (B)	59		

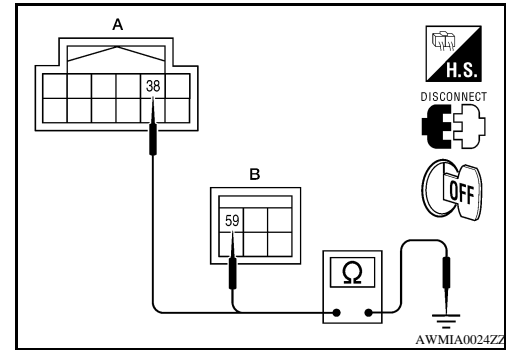

Does continuity exist?

YES >> Inspection End.

NO >> Repair or replace harness.

FUEL LEVEL SENSOR SIGNAL CIRCUIT

< COMPONENT DIAGNOSIS >

FUEL LEVEL SENSOR SIGNAL CIRCUIT

Description

INFOID:000000004056930

The fuel level sensor unit and fuel pump detects the approximate fuel level in the fuel tank and transmits the fuel level signal to the combination meter.

Component Function Check

INFOID:000000004056931

1.COMBINATION METER INPUT SIGNAL

1. Select "METER/M&A" on CONSULT-III.
2. Using "FUEL METER" of "DATA MONITOR", compare the value of DATA MONITOR with fuel gauge pointer of combination meter.

Fuel gauge pointer	Reference value of data monitor [lit.]
Full	Approx. 79.3
3/4	Approx. 58.5
1/2	Approx. 37.1
1/4	Approx. 22.4
Empty	Approx. 7.6

Does the data monitor value approximately match the fuel gauge indication?

- YES >> Inspection End.
 NO >> Replace combination meter. Refer to [MWI-93. "Removal and Installation"](#).

Diagnosis Procedure

INFOID:000000004056932

1.CHECK HARNESS CONNECTOR

1. Turn ignition switch OFF.
2. Check combination meter and fuel level sensor unit terminals (meter-side and harness-side) for poor connection.

Is the inspection result normal?

- YES >> GO TO 2
 NO >> Repair or replace terminals or connectors.

2.CHECK FUEL LEVEL SENSOR UNIT CIRCUIT

1. Disconnect combination meter connector and fuel level sensor unit connector.
2. Check continuity between combination meter harness connector and fuel level sensor unit and fuel pump harness connector.

Terminals				Continuity
(+)		(-)		
Connector	Terminal	Connector	Terminal	
C5	2	M24	9	Yes

3. Check continuity between fuel level sensor unit and fuel pump harness connector and ground.

Terminals			Continuity
(+)		(-)	
Connector	Terminal	Ground	
C5	2	Ground	No

Is the inspection result normal?

- YES >> GO TO 3

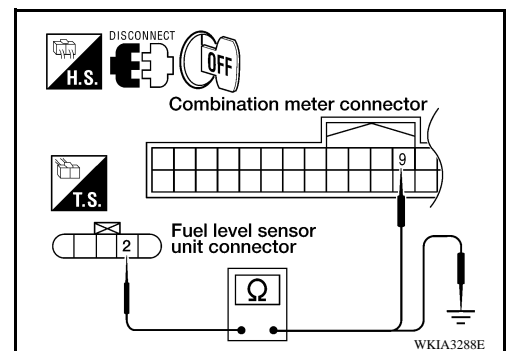

FUEL LEVEL SENSOR SIGNAL CIRCUIT

< COMPONENT DIAGNOSIS >

NO >> Repair harness or connector.

3. CHECK FUEL LEVEL SENSOR UNIT GROUND CIRCUIT

1. Check continuity between combination meter harness connector and fuel level sensor unit and fuel pump harness connector.

Terminals				Continuity
(+)		(-)		
Connector	Terminal	Connector	Terminal	
C5	5	M24	4	Yes

2. Check continuity between fuel level sensor unit and fuel pump harness connector and ground.

Terminals				Continuity
(+)		(-)		
Connector	Terminal	Ground		
C5	5	Ground		No

Is the inspection result normal?

YES >> GO TO 4

NO >> Repair harness or connector.

4. CHECK INSTALLATION CONDITION

Check fuel level sensor unit installation, and check whether the float arm interferes or binds with any of the internal components in the fuel tank.

Is the inspection result normal?

YES >> Inspection End.

NO >> Install the fuel level sensor unit properly.

Component Inspection

INFOID:000000004056933

1. REMOVE FUEL LEVEL SENSOR UNIT

Remove the fuel level sensor unit. Refer to [FL-10, "Removal and Installation"](#).

>> GO TO 2

2. CHECK FUEL LEVEL SENSOR UNIT AND FUEL PUMP

Check the resistance between terminals 2 and 5.

Terminal		Float position mm (in)		Resistance value (Approx.)
2	5	*1	Empty	10 (0.4)
		*2	Full	211.1 (8.3)
				5Ω

*1 and *2: When float arm is in contact with stopper.

Is inspection result normal?

YES >> Inspection End.

NO >> Replace fuel level sensor unit and fuel pump. Refer to [FL-10, "Removal and Installation"](#).

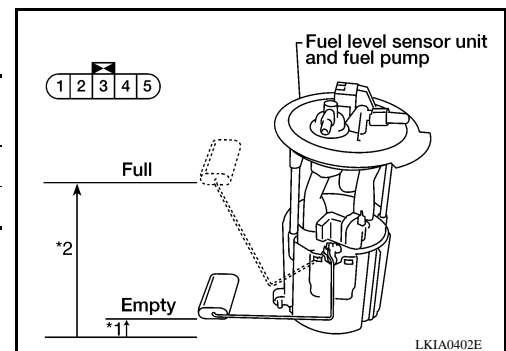
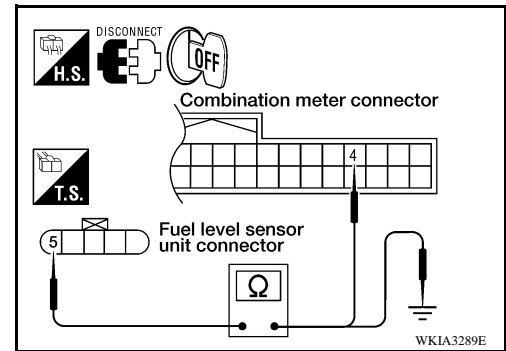

OIL PRESSURE SWITCH SIGNAL CIRCUIT

< COMPONENT DIAGNOSIS >

OIL PRESSURE SWITCH SIGNAL CIRCUIT

Description

INFOID:000000004056934

Detects the engine oil pressure and transmits the oil pressure switch signal to the IPDM E/R.

Component Function Check

INFOID:000000004056935

1.COMBINATION METER INPUT SIGNAL

1. Select "METER/M&A" on CONSULT-III.
2. Monitor "OIL W/L" of "DATA MONITOR" while operating ignition switch.

OIL W/L

When ignition switch is in ON : ON
position (Engine stopped)

When engine is running : OFF

>> Inspection End.

Diagnosis Procedure

INFOID:000000004056936

1.CHECK OIL PRESSURE SWITCH CIRCUIT

1. Turn ignition switch OFF.
2. Disconnect IPDM E/R connector E122 and oil pressure switch connector E208 (VQ40DE) or F4 (QR25DE).
3. Check continuity between IPDM E/R harness connector E122 (A) terminal 42 and oil pressure switch harness connector E208 (VQ40DE) or F4 (QR25DE) (B) terminal 1.

Continuity should exist.

Is the inspection result normal?

- YES >> Inspection End.
NO >> Repair harness or connector.

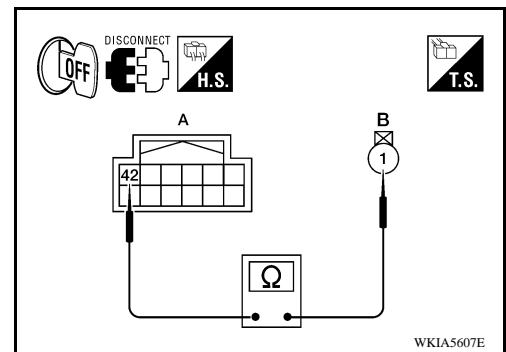

Component Inspection

INFOID:000000004056937

1.CHECK OIL PRESSURE SWITCH

Check continuity between oil pressure switch and ground.

Condition	Oil pressure [kPa (kg/cm ² , psi)]	Continuity
Engine stopped	Less than 29 (0.3, 4)	Yes
Engine running	More than 29 (0.3, 4)	No

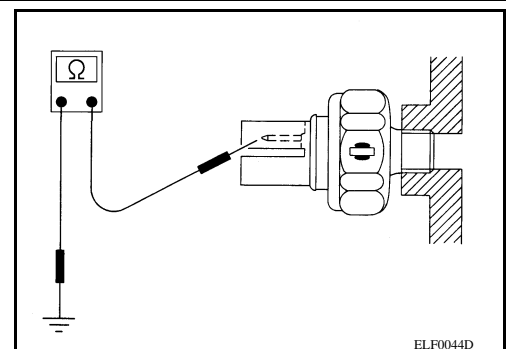

Is the inspection result normal?

- YES >> Inspection End.
NO >> Replace the oil pressure switch.

COMPASS

< COMPONENT DIAGNOSIS >

COMPASS

Wiring Diagram

INFOID:000000004056938

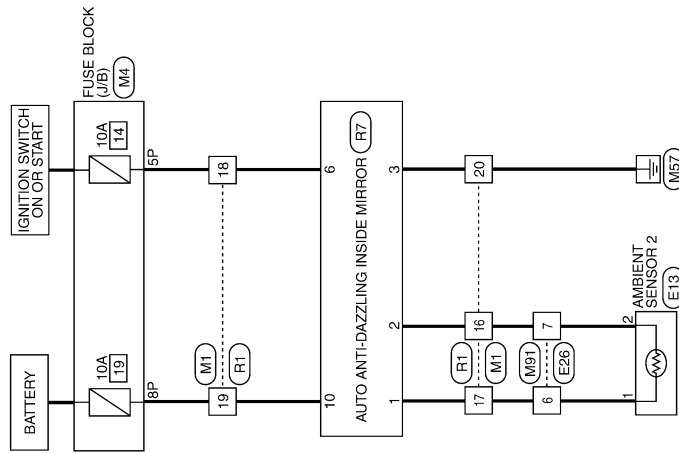

COMPASS

A
B
C
D
E
F
G
H
I
J
K
L
M
MWI
O
P

AWNWA0110G1

COMPASS CONNECTORS

Connector No.	M1
Connector Name	WIRE TO WIRE
Connector Color	WHITE

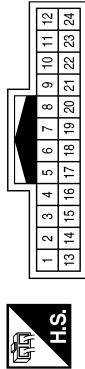

Terminal No.	Color of Wire	Signal Name
16	V	-
17	LG	-
18	W/G	-
19	R/Y	-
20	B	-

Connector No.	M4
Connector Name	FUSE BLOCK (J/B)
Connector Color	WHITE

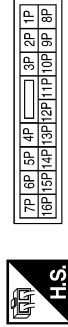

Terminal No.	Color of Wire	Signal Name
5P	W/G	-
8P	R/Y	-

Connector No.	M91
Connector Name	WIRE TO WIRE
Connector Color	WHITE

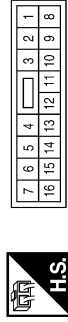

Terminal No.	Color of Wire	Signal Name
6	LG	-
7	V	-

Connector No.	E13
Connector Name	AMBIENT SENSOR 2
Connector Color	BLACK



Terminal No.	Color of Wire	Signal Name
1	LG	TEMP+
2	V	TEMP-

Connector No.	E26
Connector Name	WIRE TO WIRE
Connector Color	WHITE

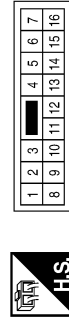

Terminal No.	Color of Wire	Signal Name
6	LG	-
7	V	-

Connector No.	R1
Connector Name	WIRE TO WIRE
Connector Color	WHITE

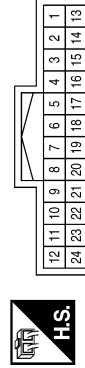

Terminal No.	Color of Wire	Signal Name
16	V	-
17	LG	-
18	W/G	-
19	R/Y	-
20	B	-

COMPASS

< COMPONENT DIAGNOSIS >

A
B
C
D
E
F
G
H
I
J
K
L
M
N
O
P

Connector No.	R7
Connector Name	AUTO ANTI-DAZZLING INSIDE MIRROR
Connector Color	BLACK

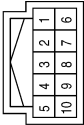

Terminal No.	Color of Wire	Signal Name
1	LG	TEMP+
2	V	TEMP-
3	B	GND
6	W/G	IGN
10	R/Y	BATT

MWI

ABNIA0553GB

COMBINATION METER

< ECU DIAGNOSIS >

ECU DIAGNOSIS

COMBINATION METER

Reference Value

INFOID:000000004056939

TERMINAL LAYOUT

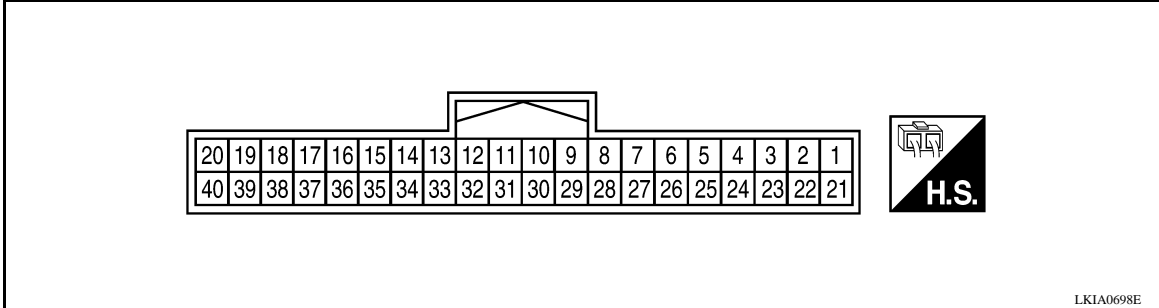

PHYSICAL VALUES

Terminal	Wire color	Item	Condition		Reference value (V) (Approx.)
			Ignition switch	Operation or condition	
2	P	Generator	ON	Generator voltage low	0
				Generator voltage normal	Battery voltage
3	R/Y	Battery power supply	—	—	Battery voltage
4	B/Y	Fuel level sensor ground	ON	—	0
5	W	Vehicle speed signal output (2-pulse)	ON	Speedometer operated [When vehicle speed is approx. 20 km/h (12 MPH)]	240 Hz
6	SB	Vehicle speed signal output (8-pulse)	ON	Speedometer operated [When vehicle speed is approx. 40 km/h (25 MPH)]	<p>NOTE: Maximum voltage may be 12V due to specifications (connected units).</p> <p>PKIC0643E</p>
9	BR	Fuel level sensor signal	—	—	Refer to MWI-11, "FUEL GAUGE : System Description" .
11	P	CAN-L	—	—	—
12	L	CAN-H	—	—	—
13	GR	Ground	—	—	0
16	W/G	Ignition switch ON or START	ON	—	Battery voltage
22	BR	Illumination control switch	—	—	Refer to INL-9, "System Description" .
23	B	Ground	—	—	0
24	V	Seat belt buckle switch LH	ON	Unfastened (ON)	0
				Fastened (OFF)	Battery voltage
25	SB	DIFF LOCK indicator input	ON	DIFF LOCK indicator ON	0
				DIFF LOCK indicator OFF	Battery voltage

COMBINATION METER

< ECU DIAGNOSIS >

Terminal	Wire color	Item	Condition		Reference value (V) (Approx.)	
			Ignition switch	Operation or condition		
31	G	Parking brake switch	ON	Parking brake applied	0	A
				Parking brake released	Battery voltage	B
32	SB	Brake fluid level switch	ON	Brake fluid level low	0	C
				Brake fluid level normal	Battery voltage	C
33	LG	Stop lamp switch	—	Brake pedal depressed	Battery voltage	D
				Brake pedal released	0	D
34	L	Washer fluid level switch	ON	Washer fluid level low	0	E
				Washer fluid level normal	Battery voltage	E
37	SB	Air bag warning lamp input	ON	Air bag warning lamp ON	4	F
				Air bag warning lamp OFF	0	F
39	G	Security indicator input	OFF	Security indicator ON	0	G
				Security indicator OFF	Battery voltage	G
40	LG	Seat belt buckle switch RH	ON	Unfastened (ON)	0	H
				Fastened (OFF)	Battery voltage	H

A
B
C
D
E
F
G
H
I
J
K
L
M
N
O
P

MWI

COMBINATION METER

< ECU DIAGNOSIS >

Wiring Diagram

INFOID:000000004056940

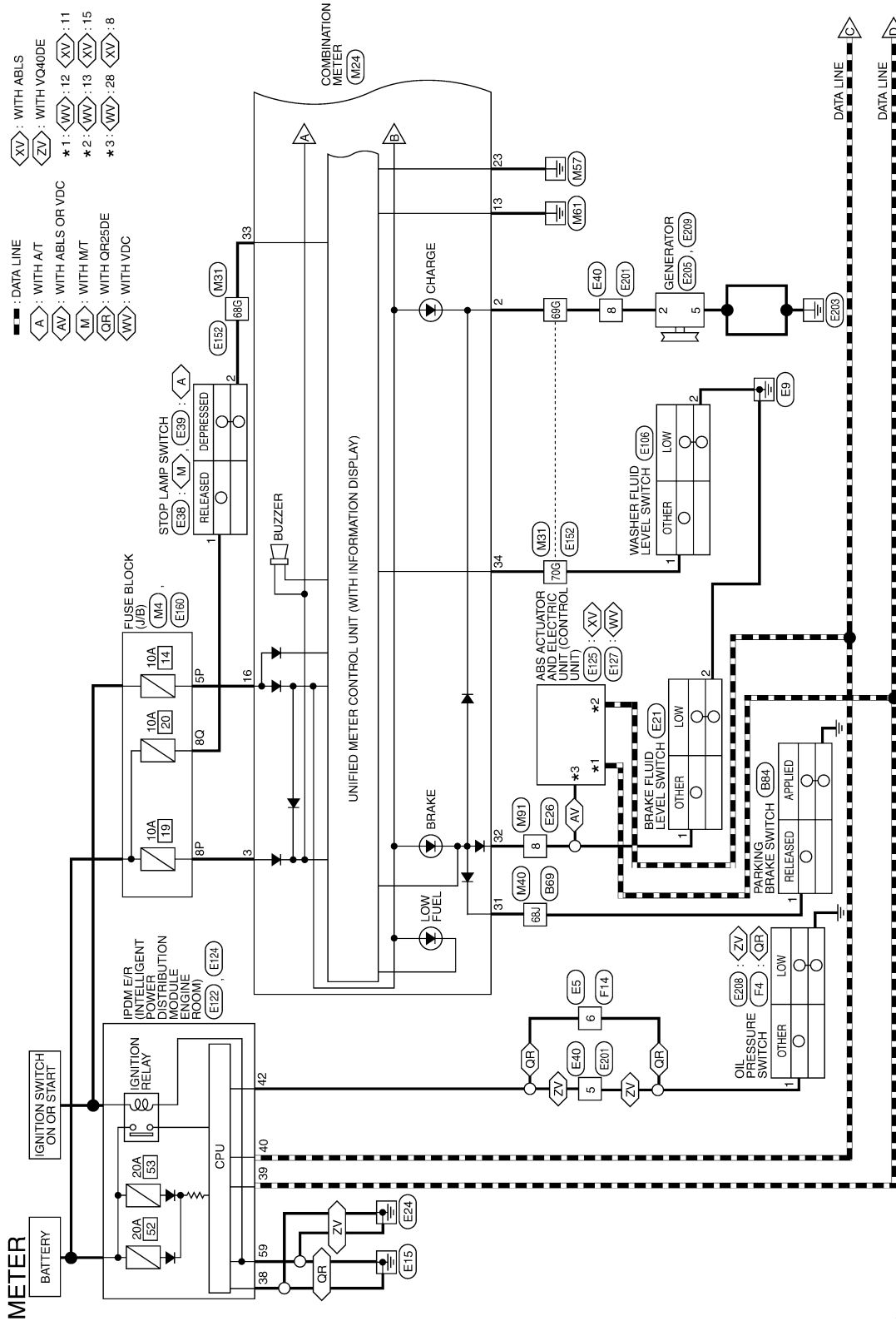

ABNWA0172GE

COMBINATION METER

< ECU DIAGNOSIS >

- : DATA LINE
- ◁ : CREW CAB
- ◁ : EXCEPT BASE AUDIO SYSTEM
- ◁ : KING CAB
- ◁ : WITH SUNROOF

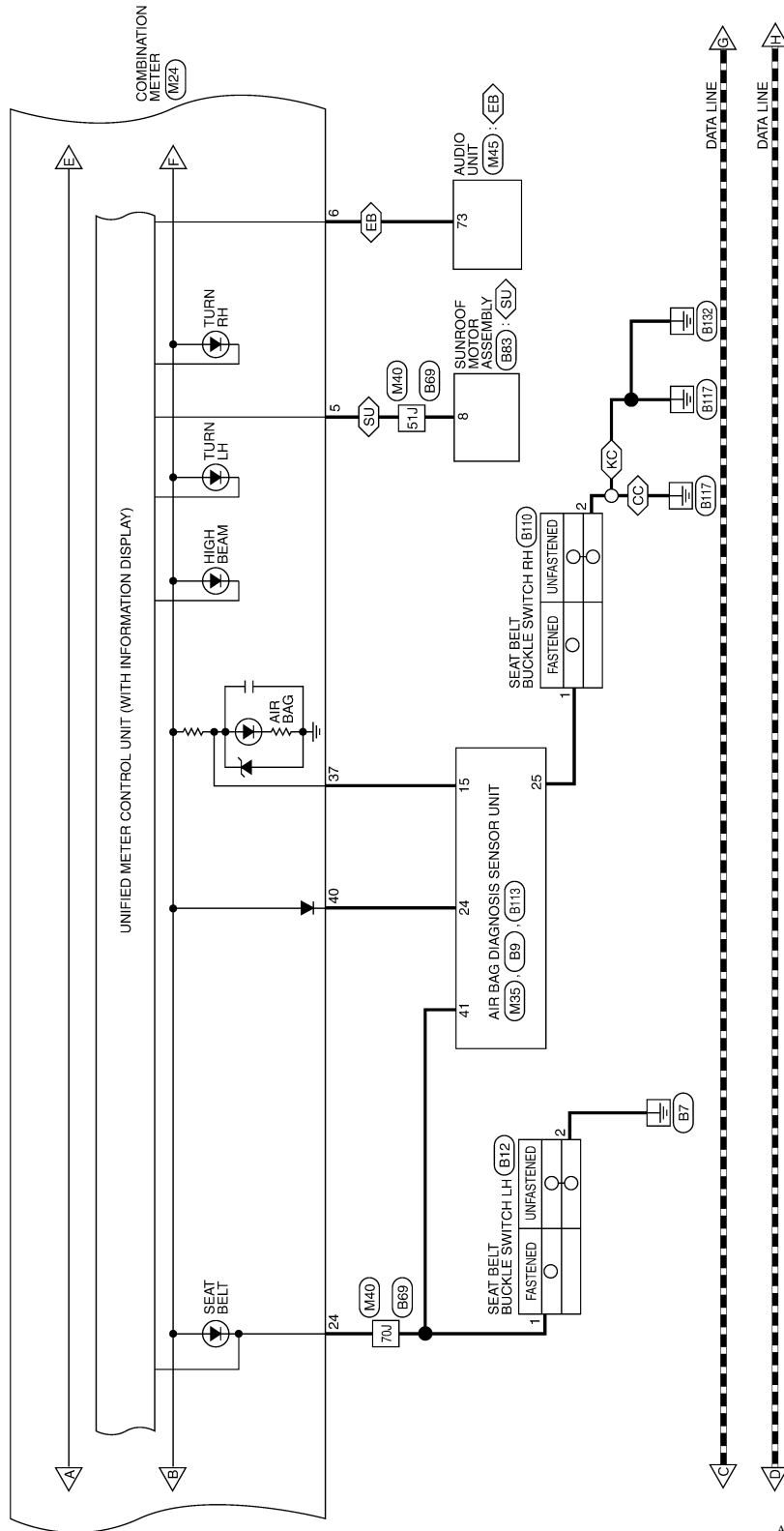

ABNWA0173GE

A
B
C
D
E
F
G
H
I
J
K
L
M
MWI
O
P

COMBINATION METER

< ECU DIAGNOSIS >

- : DATA LINE
- A : WITH A/T
- AS : WITH ASCD
- M : WITH M/T

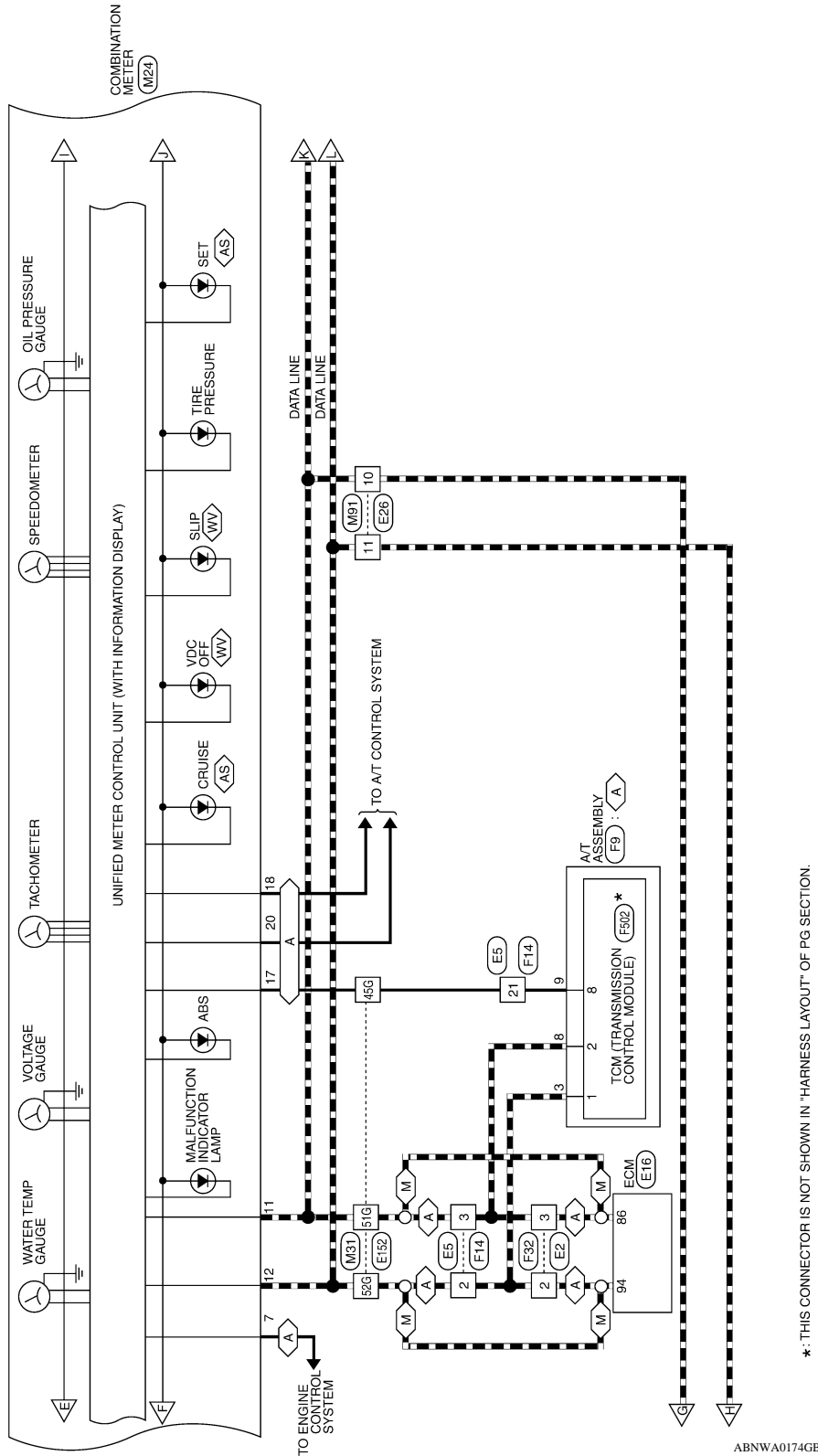

ABNWA0174GE

COMBINATION METER

< ECU DIAGNOSIS >

- : DATA LINE
- ◁ A ▷ : WITH A/T
- ◁ CC ▷ : CREW CAB
- ◁ KC ▷ : KING CAB
- ◁ W ▷ : WITH IMMOBILIZER

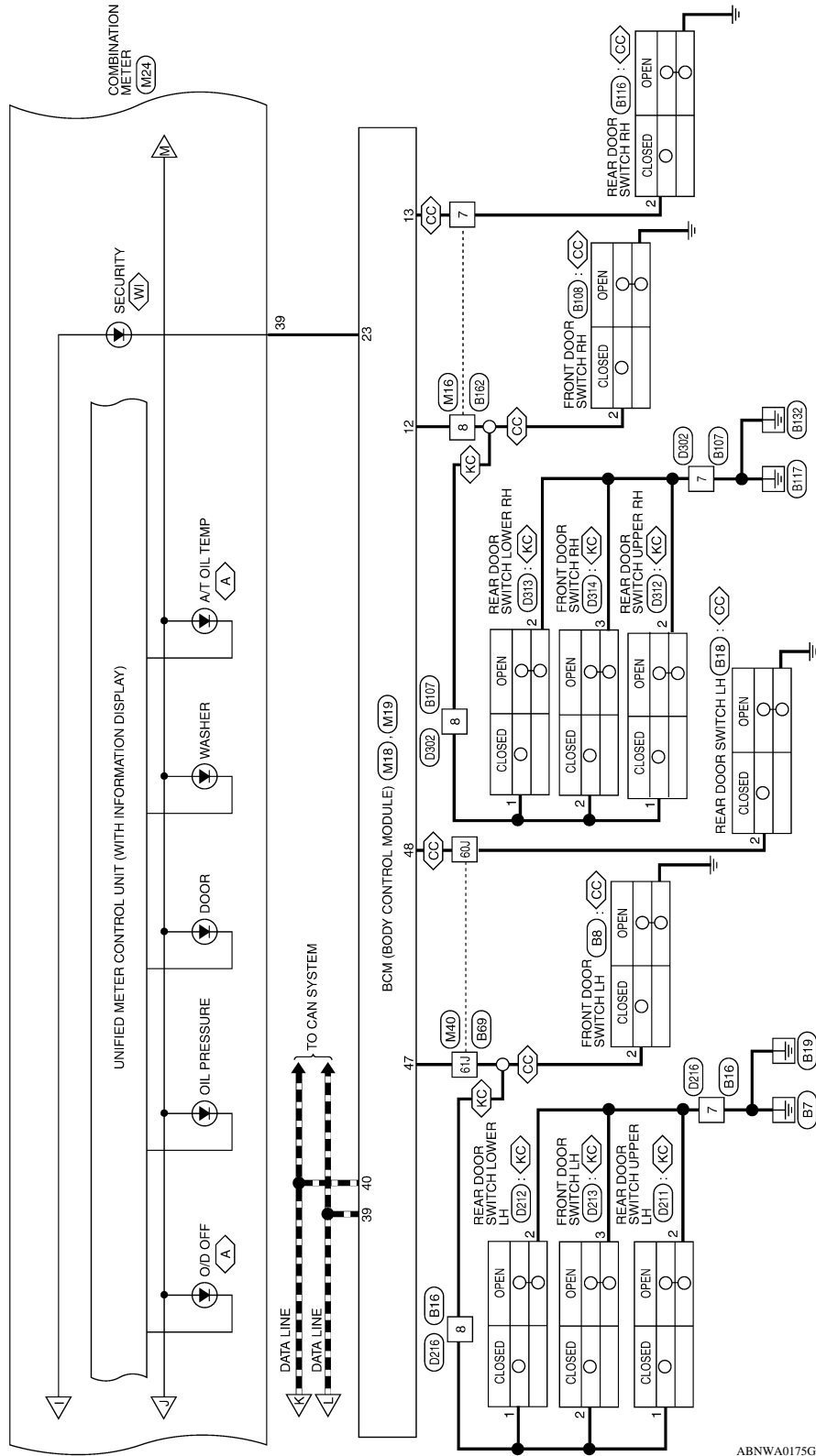

ABNWA0175GE

A
B
C
D
E
F
G
H
I
J
K
L
M
N
O
P

MWI

COMBINATION METER

< ECU DIAGNOSIS >

- <4W> : WITH 4-WHEEL DRIVE
- <AW> : WITH A/T AND 4-WHEEL DRIVE
- <DL> : WITH ELECTRONIC LOCKING REAR DIFFERENTIAL
- <WV> : WITH VDC

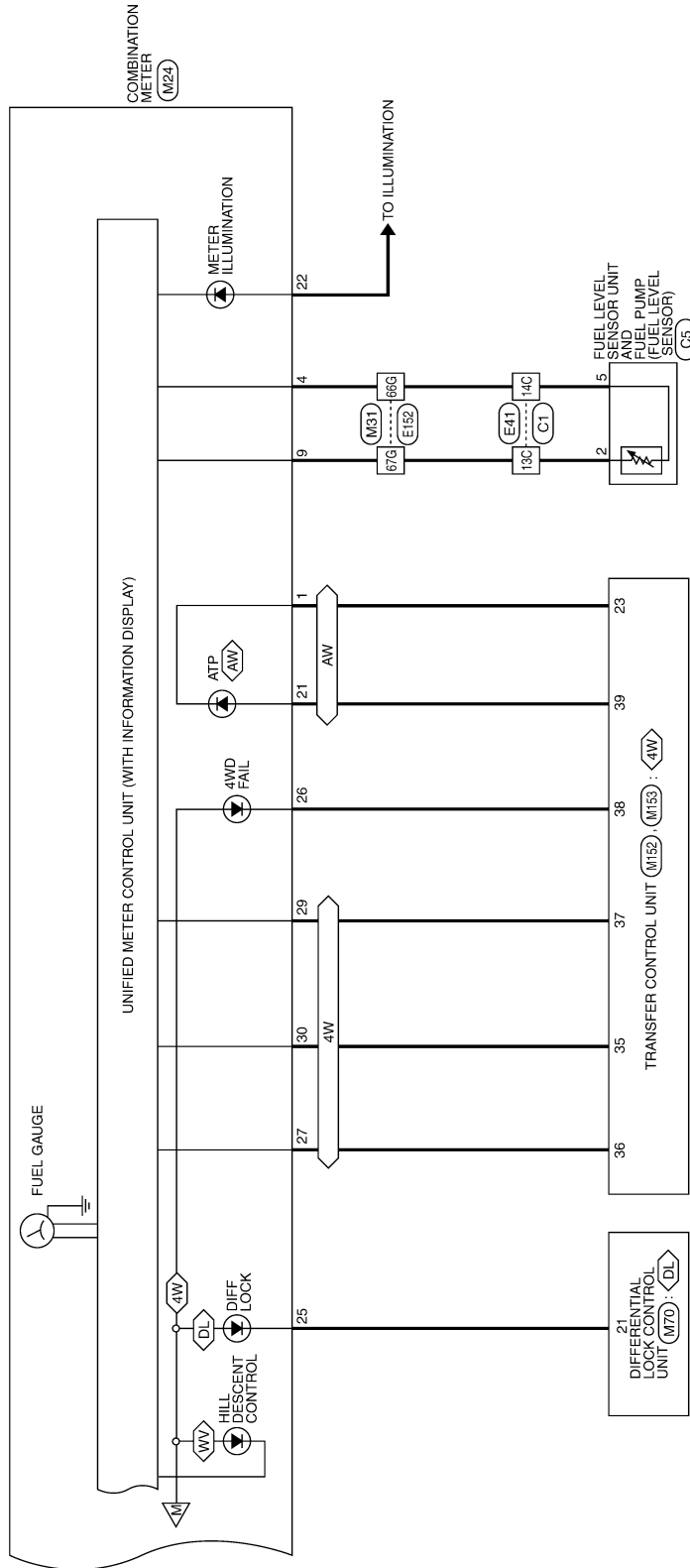

ABNWA0176GE

COMBINATION METER

< ECU DIAGNOSIS >

METER CONNECTORS

Connector No.	M4
Connector Name	FUSE BLOCK (J/B)
Connector Color	WHITE



Terminal No.	Color of Wire	Signal Name
5P	W/G	-
8P	R/Y	-

Connector No.	M16
Connector Name	WIRE TO WIRE
Connector Color	WHITE

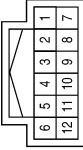

Terminal No.	Color of Wire	Signal Name
7	L	-
8	LG	-

Connector No.	M18
Connector Name	BCM (BODY CONTROL MODULE)
Connector Color	WHITE

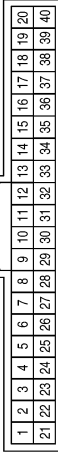

Terminal No.	Color of Wire	Signal Name
12	LG	DOOR SW (AS)
13	L	DOOR SW (RR)
23	G	SECURITY INDICATOR OUTPUT
39	L	CAN-H
40	P	CAN-L

Connector No.	M19
Connector Name	BCM (BODY CONTROL MODULE)
Connector Color	WHITE

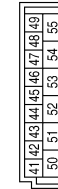

Terminal No.	Color of Wire	Signal Name
47	GR	DOOR SW (DR)
48	P	DOOR SW (RL)

A
B
C
D
E
F
G
H
I
J
K
L
M
N
O
P

MWI

ABNIA0540GB

COMBINATION METER

< ECU DIAGNOSIS >

Connector No.	M24
Connector Name	COMBINATION METER
Connector Color	WHITE

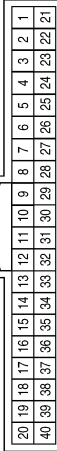

Terminal No.	Color of Wire	Signal Name
1	R	ATP-
2	P	CHARGE (ALT) INPUT
3	R/Y	BATTERY
4	B/Y	FUEL SENDER RETURN
5	W	SPEED OUT 2
6	SB	SPEED OUT 8
7	G	AT-PN ECM
8	-	-
9	BR	FUEL SENDER INPUT
10	-	-
11	P	CAN-L
12	L	CAN-H
13	GR	GROUND
14	-	-
15	-	-
16	W/G	RUN START
17	B	AT-PN SWITCH
18	L	AT 1 RANGE SWITCH
19	-	-
20	Y	O/D OFF SWITCH

Terminal No.	Color of Wire	Signal Name
21	LG	ATP+
22	BR	ILLUMINATION CONTROL
23	B	POWER GND
24	V	BUCKLE (SEATBELT) SW
25	SB	DIFF LOCK
26	GR	4WD FAIL
27	BR	4WD (LOCK) INPUT
28	-	-
29	O	4WD (4LO) INPUT
30	V	4WD (2WD) INPUT
31	G	PARK BRAKE SW
32	SB	BRAKE OIL SWITCH
33	LG	BRAKE PEDAL SW
34	L	WASHER FLUID SW
35	-	-
36	-	-
37	SB	AIRBAG CONT
38	-	-
39	G	SECURITY
40	LG	PASS SEATBELT

Connector No.	M31
Connector Name	WIRE TO WIRE
Connector Color	WHITE

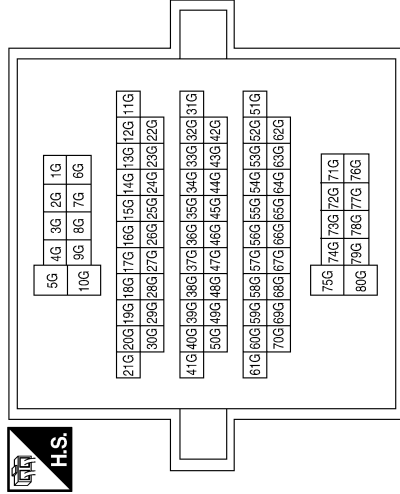

Terminal No.	Color of Wire	Signal Name
45G	B	-
51G	P	-
52G	L	-
66G	B/Y	-
67G	BR	-
68G	LG	-
69G	P	-
70G	L	-

ABNIA0541GB

COMBINATION METER

< ECU DIAGNOSIS >

Connector No.	M35
Connector Name	AIR BAG DIAGNOSIS SENSOR UNIT
Connector Color	YELLOW

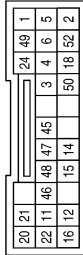

Terminal No.	Color of Wire	Signal Name
15	SB	WARN LP
24	LG	SEATBELT REMINDER

Connector No.	M40
Connector Name	WIRE TO WIRE
Connector Color	WHITE

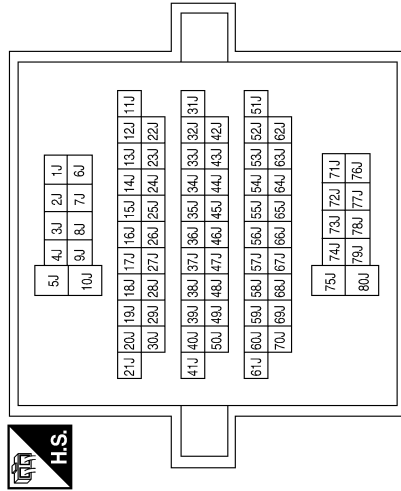

Terminal No.	Color of Wire	Signal Name
51J	W	-
60J	P	-
61J	GR	-
68J	G	-
70J	V	-

Connector No.	M45
Connector Name	AUDIO UNIT
Connector Color	WHITE

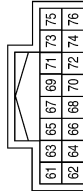

Terminal No.	Color of Wire	Signal Name
73	SB	SPEED SIGNAL

Connector No.	M70
Connector Name	DIFFERENTIAL LOCK CONTROL UNIT
Connector Color	WHITE



Terminal No.	Color of Wire	Signal Name
21	SB	DIFF LOCK IND

Connector No.	M91
Connector Name	WIRE TO WIRE
Connector Color	WHITE

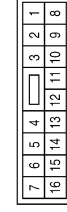

Terminal No.	Color of Wire	Signal Name
8	SB	-
10	P	-
11	L	-

ABNIA0542GB

A B C D E F G H I J K L M O P

MWI

COMBINATION METER

< ECU DIAGNOSIS >

Connector No.	M152
Connector Name	TRANSFER CONTROL UNIT
Connector Color	WHITE

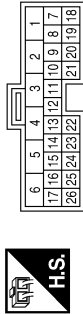

Terminal No.	Color of Wire	Signal Name
23	R	ATP SW

Connector No.	M153
Connector Name	TRANSFER CONTROL UNIT
Connector Color	WHITE

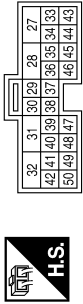

Terminal No.	Color of Wire	Signal Name
35	V	2WD IND
36	BR	LOCK IND
37	O	4LO IND
38	GR	4WD FAIL IND
39	LG	ATP IND

Connector No.	E2
Connector Name	WIRE TO WIRE
Connector Color	WHITE

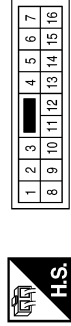

Terminal No.	Color of Wire	Signal Name
2	L	-
3	P	-

Connector No.	E5
Connector Name	WIRE TO WIRE
Connector Color	WHITE

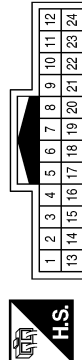

Terminal No.	Color of Wire	Signal Name
2	L	-
3	P	-
6	GR	-
21	R	-

Connector No.	E16
Connector Name	ECM
Connector Color	BLACK

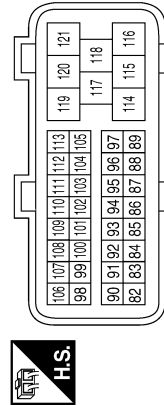

Terminal No.	Color of Wire	Signal Name
86	P	CAN-L
94	L	CAN-H

Connector No.	E21
Connector Name	BRAKE FLUID LEVEL SWITCH
Connector Color	GRAY



Terminal No.	Color of Wire	Signal Name
1	SB	-
2	B	-

COMBINATION METER

< ECU DIAGNOSIS >

Connector No.	E26
Connector Name	WIRE TO WIRE
Connector Color	WHITE

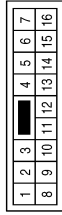

Terminal No.	Color of Wire	Signal Name
8	SB	-
10	P	-
11	L	-

Connector No.	E38
Connector Name	STOP LAMP SWITCH (WITH M/T)
Connector Color	BLACK



Terminal No.	Color of Wire	Signal Name
1	R/B	-
2	Y	-

Connector No.	E39
Connector Name	STOP LAMP SWITCH (WITH A/T)
Connector Color	WHITE



Terminal No.	Color of Wire	Signal Name
1	R/B	-
2	Y	-

Connector No.	E40
Connector Name	WIRE TO WIRE
Connector Color	GRAY

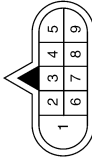

Terminal No.	Color of Wire	Signal Name
5	GR	-
8	P	-

Connector No.	E41
Connector Name	WIRE TO WIRE
Connector Color	BLACK

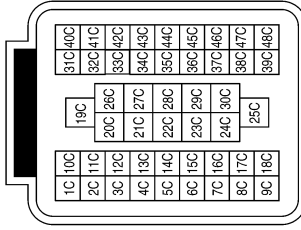

Terminal No.	Color of Wire	Signal Name
13C	BR	-
14C	B/Y	-

Connector No.	E106
Connector Name	WASHER FLUID LEVEL SWITCH
Connector Color	BROWN



Terminal No.	Color of Wire	Signal Name
1	L	-
2	B	-

ABNIA0544GB

A
B
C
D
E
F
G
H
I
J
K
L
M
MWI
O
P

COMBINATION METER

< ECU DIAGNOSIS >

Connector No.	E122
Connector Name	IPDM E/R (INTELLIGENT POWER DISTRIBUTION MODULE ENGINE ROOM)
Connector Color	WHITE

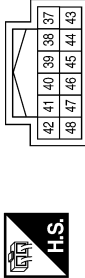

Terminal No.	Color of Wire	Signal Name
38	B	GND (SIGNAL)
39	L	CAN-H
40	P	CAN-L
42	GR	OIL PRESSURE SW

Connector No.	E124
Connector Name	IPDM E/R (INTELLIGENT POWER DISTRIBUTION MODULE ENGINE ROOM)
Connector Color	BLACK



Terminal No.	Color of Wire	Signal Name
59	B	GND (POWER)

Connector No.	E125
Connector Name	ABS ACTUATOR AND ELECTRIC UNIT (CONTROL UNIT) (WITHOUT VDC)
Connector Color	BLACK

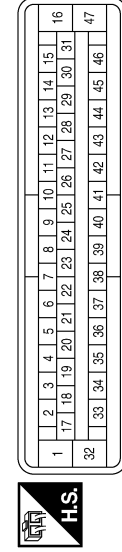

Terminal No.	Color of Wire	Signal Name
8	GR	BRAKE LEVEL SW (WITH ABL)
11	L	CAN-H
15	P	CAN-L

Connector No.	E127
Connector Name	ABS ACTUATOR AND ELECTRIC UNIT (CONTROL UNIT) (WITH VDC)
Connector Color	BLACK

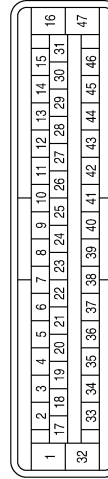

Terminal No.	Color of Wire	Signal Name
12	L	CAN-H
13	P	CAN-L
28	GR	BRAKE LEVEL SW

Connector No.	E152
Connector Name	WIRE TO WIRE
Connector Color	WHITE

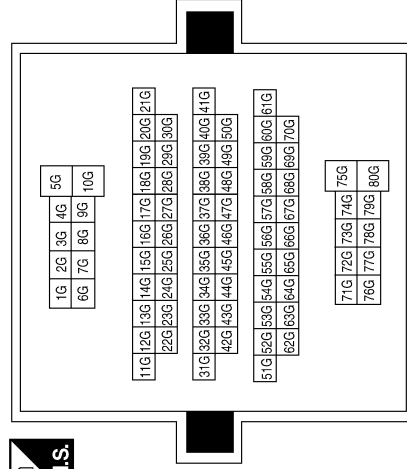

Terminal No.	Color of Wire	Signal Name
45G	B	-
51G	P	-
52G	L	-
66G	B/Y	-
67G	BR	-
68G	LG	-
69G	P	-
70G	L	-

ABNIA0545GB

COMBINATION METER

< ECU DIAGNOSIS >

Connector No.	E160
Connector Name	FUSE BLOCK (J/B)
Connector Color	WHITE

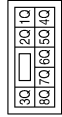

Terminal No.	Color of Wire	Signal Name
8Q	R/B	-

Connector No.	E201
Connector Name	WIRE TO WIRE
Connector Color	GRAY

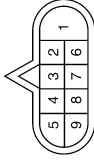

Terminal No.	Color of Wire	Signal Name
5	GR	-
8	P	-

Connector No.	E205
Connector Name	GENERATOR
Connector Color	BLACK



Terminal No.	Color of Wire	Signal Name
2	P	L

Connector No.	E208
Connector Name	OIL PRESSURE SWITCH (WITH VQ40DE)
Connector Color	GRAY



Terminal No.	Color of Wire	Signal Name
1	GR	-

Connector No.	E209
Connector Name	GENERATOR
Connector Color	-



Terminal No.	Color of Wire	Signal Name
5	B	E

Connector No.	F4
Connector Name	OIL PRESSURE SWITCH (WITH QR25DE)
Connector Color	GRAY



Terminal No.	Color of Wire	Signal Name
1	GR	-

ABNIA0546GB

A
B
C
D
E
F
G
H
I
J
K
L
M
MWI
O
P

COMBINATION METER

< ECU DIAGNOSIS >

Connector No.	F9
Connector Name	A/T ASSEMBLY
Connector Color	GREEN

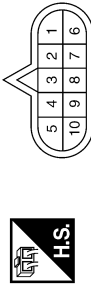

Terminal No.	Color of Wire	Signal Name
3	L	-
8	P	-
9	R	-

Connector No.	F14
Connector Name	WIRE TO WIRE
Connector Color	WHITE

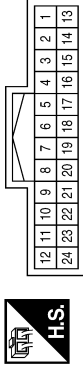

Terminal No.	Color of Wire	Signal Name
2	L	-
3	P	-
6	GR	-
21	R	-

Connector No.	F32
Connector Name	WIRE TO WIRE
Connector Color	WHITE

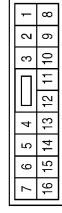

Terminal No.	Color of Wire	Signal Name
2	L	-
3	P	-

Connector No.	F502
Connector Name	TCM (TRANSMISSION CONTROL MODULE)
Connector Color	GRAY

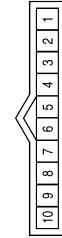

Terminal No.	Color of Wire	Signal Name
1	BR	CAN-H
2	L/Y	CAN-L
8	G	STARTER-RLY

Connector No.	C1
Connector Name	WIRE TO WIRE
Connector Color	BLACK

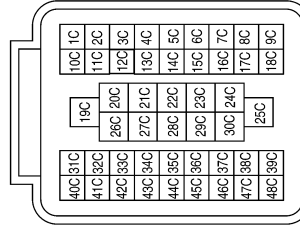

Terminal No.	Color of Wire	Signal Name
13C	BR	-
14C	B/Y	-

Connector No.	C5
Connector Name	FUEL LEVEL SENSOR UNIT AND FUEL PUMP
Connector Color	GRAY

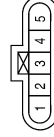

Terminal No.	Color of Wire	Signal Name
2	BR	-
5	B	-

ABNIA0547GB

COMBINATION METER

< ECU DIAGNOSIS >

Connector No.	B12
Connector Name	SEAT BELT BUCKLE SWITCH LH
Connector Color	WHITE



Terminal No.	Color of Wire	Signal Name
1	O	-
2	B	-

Connector No.	B9
Connector Name	AIR BAG DIAGNOSIS SENSOR UNIT
Connector Color	YELLOW

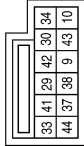

Terminal No.	Color of Wire	Signal Name
41	O	BUCKLE SW LH

Connector No.	B8
Connector Name	FRONT DOOR SWITCH LH (CREW CAB)
Connector Color	WHITE

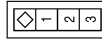

Terminal No.	Color of Wire	Signal Name
2	GR	-

Connector No.	B18
Connector Name	REAR DOOR SWITCH LH
Connector Color	WHITE

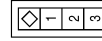

Terminal No.	Color of Wire	Signal Name
2	P	-

Connector No.	B16
Connector Name	WIRE TO WIRE
Connector Color	WHITE

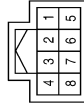

Terminal No.	Color of Wire	Signal Name
7	B	-
8	GR	-

ABNIA0548GB

A
B
C
D
E
F
G
H
I
J
K
L
M
N
O
P

MWI

COMBINATION METER

< ECU DIAGNOSIS >

Connector No.	B69
Connector Name	WIRE TO WIRE
Connector Color	WHITE

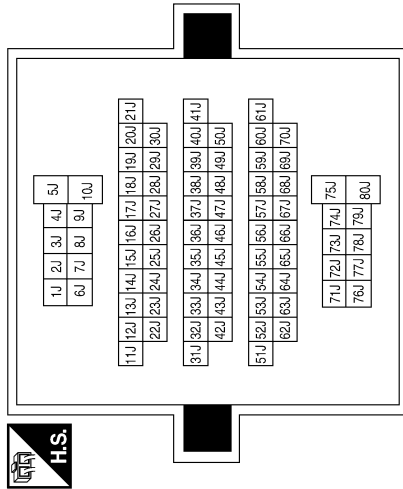

Terminal No.	Color of Wire	Signal Name
51J	W	-
60J	P	-
61J	GR	-
68J	G	-
70J	V	-

Connector No.	B83
Connector Name	SUNROOF MOTOR ASSEMBLY
Connector Color	BLACK

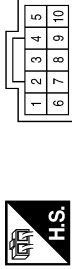

Terminal No.	8	Color of Wire	W	Signal Name	-
--------------	---	---------------	---	-------------	---

Connector No.	B84
Connector Name	PARKING BRAKE SWITCH
Connector Color	BLACK



Terminal No.	1	Color of Wire	G	Signal Name	-
--------------	---	---------------	---	-------------	---

Connector No.	B107
Connector Name	WIRE TO WIRE
Connector Color	WHITE



Terminal No.	7	Color of Wire	B	Signal Name	-
8	LG	-	-	-	-

Connector No.	B108
Connector Name	FRONT DOOR SWITCH RH (CREW CAB)
Connector Color	WHITE



Terminal No.	2	Color of Wire	LG	Signal Name	-
--------------	---	---------------	----	-------------	---

ABNIA0549GB

COMBINATION METER

< ECU DIAGNOSIS >

Connector No.	B116
Connector Name	REAR DOOR SWITCH RH
Connector Color	WHITE

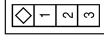

Terminal No.	2	Color of Wire	L	Signal Name	-
--------------	---	---------------	---	-------------	---

Connector No.	B113
Connector Name	AIR BAG DIAGNOSIS SENSOR UNIT
Connector Color	YELLOW

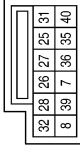

Terminal No.	25	Color of Wire	L	Signal Name	BUCKLE SW RH
--------------	----	---------------	---	-------------	--------------

Connector No.	B110
Connector Name	SEAT BELT BUCKLE SWITCH RH
Connector Color	WHITE

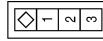

Terminal No.	1	Color of Wire	L	Signal Name	-
2		B		-	

Connector No.	D212
Connector Name	REAR DOOR SWITCH LOWER LH
Connector Color	BLACK



Terminal No.	1	Color of Wire	L	Signal Name	-
2		B		-	

Connector No.	D211
Connector Name	REAR DOOR SWITCH UPPER LH
Connector Color	BLACK



Terminal No.	1	Color of Wire	LG	Signal Name	-
2		B		-	

Connector No.	B162
Connector Name	WIRE TO WIRE
Connector Color	WHITE

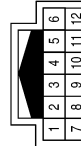

Terminal No.	7	Color of Wire	L	Signal Name	-
8		LG		-	

ABNIA0550GB

A
B
C
D
E
F
G
H
I
J
K
L
M
N
O
P

COMBINATION METER

< ECU DIAGNOSIS >

Connector No.	D302
Connector Name	WIRE TO WIRE
Connector Color	WHITE

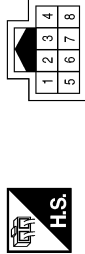

Terminal No.	Color of Wire	Signal Name
7	B	-
8	LG	-

Connector No.	D216
Connector Name	WIRE TO WIRE
Connector Color	WHITE

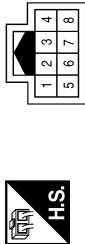

Terminal No.	Color of Wire	Signal Name
7	B	-
8	LG	-

Connector No.	D213
Connector Name	FRONT DOOR SWITCH LH (KING CAB)
Connector Color	WHITE



Terminal No.	Color of Wire	Signal Name
2	LG	-
3	B	-

Connector No.	D314
Connector Name	FRONT DOOR SWITCH RH (KING CAB)
Connector Color	WHITE



Terminal No.	Color of Wire	Signal Name
2	LG	-
3	B	-

Connector No.	D313
Connector Name	REAR DOOR SWITCH LOWER RH
Connector Color	BLACK



Terminal No.	Color of Wire	Signal Name
1	L	-
2	B	-

Connector No.	D312
Connector Name	REAR DOOR SWITCH UPPER RH
Connector Color	BLACK

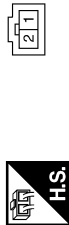

Terminal No.	Color of Wire	Signal Name
1	L	-
2	B	-

ABNIA0551GB

INFOID:000000004056941

Fail Safe

The combination meter performs a fail-safe operation for the functions listed below when communication is lost.

COMBINATION METER

< ECU DIAGNOSIS >

Function		Specifications	
Speedometer		Zero indication.	A
Tachometer			B
Fuel gauge			C
Engine coolant temperature gauge			
Engine oil pressure gauge (with VQ40DE)			
Voltage gauge (with VQ40DE)			
Illumination control	Meter illumination	Change to nighttime mode when communication is lost.	
Segment LCD	Odometer	Freeze current indication.	D
	A/T position	Display turns off.	
Buzzer		Buzzer turns off.	E
Warning lamp/indicator lamp	ABS warning lamp	Lamp turns on when communication is lost.	
	Brake warning lamp		
	VDC OFF indicator lamp		
	SLIP indicator lamp		
	AT oil temp warning lamp	Lamp turns off when communication is lost.	G
	Low washer fluid warning lamp		
	Hill descent control indicator lamp		
	Door open warning lamp		
	CRUISE indicator lamp		
	SET indicator lamp		
	O/D OFF indicator lamp		
	Oil pressure warning lamp		
	Malfunction indicator lamp		
	Air bag warning lamp		
	High beam indicator		
	Turn signal indicator lamp		
	Driver and passenger seat belt warning lamp	Lamp turns off when disconnected.	
	Charge warning lamp		
	Security indicator lamp		
	4WD indicator lamp		
ATP indicator lamp			
Differential lock indicator lamp			
Low tire pressure warning lamp	Lamp will flash every second for 1 minute and then stay on continuously thereafter.	MWI	

MWI

O

P

COMBINATION METER

< ECU DIAGNOSIS >

DTC Index

INFOID:000000004056942

CONSULT-III display	Malfunction	Reference page
CAN COMM CIRC [U1000]	Malfunction is detected in CAN communication. CAUTION: Even when there is no malfunction on CAN communication system, malfunction may be misinterpreted when battery has low voltage (when maintaining 7 - 8 V for about 2 seconds) or 10A fuse [No. 19, located in the fuse block (J/B)] is disconnected.	MWI-27
VEHICLE SPEED CIRC [B2205]	Malfunction is detected when an erroneous speed signal is input. CAUTION: Even when there is no malfunction on speed signal system, malfunction may be misinterpreted when battery has low voltage (when maintaining 7 - 8 V for about 2 seconds).	MWI-28

NOTE:

“TIME” indicates the following.

- 0: Indicates that a malfunction is detected at present.
- 1-63: Indicates that a malfunction was detected in the past. (Displays number of ignition switch OFF → ON cycles after malfunction is detected. Self-diagnosis result is erased when “63” is exceeded.)

BCM (BODY CONTROL MODULE)

< ECU DIAGNOSIS >

BCM (BODY CONTROL MODULE)

Reference Value

INFOID:000000004459296

VALUES ON THE DIAGNOSIS TOOL

Monitor Item	Condition	Value/Status
IGN ON SW	Ignition switch OFF or ACC	OFF
	Ignition switch ON	ON
KEY ON SW	Mechanical key is removed from key cylinder	OFF
	Mechanical key is inserted to key cylinder	ON
CDL LOCK SW	Door lock/unlock switch does not operate	OFF
	Press door lock/unlock switch to the lock side	ON
CDL UNLOCK SW	Door lock/unlock switch does not operate	OFF
	Press door lock/unlock switch to the unlock side	ON
DOOR SW-DR	Driver's door closed	OFF
	Driver's door opened	ON
DOOR SW-AS	Passenger door closed	OFF
	Passenger door opened	ON
DOOR SW-RR	Rear RH door closed	OFF
	Rear RH door opened	ON
DOOR SW-RL	Rear LH door closed	OFF
	Rear LH door opened	ON
BACK DOOR SW	NOTE: The item is indicated, but not monitored.	—
KEY CYL LK-SW	Other than driver door key cylinder LOCK position	OFF
	Driver door key cylinder LOCK position	ON
KEY CYL UN-SW	Other than driver door key cylinder UNLOCK position	OFF
	Driver door key cylinder UNLOCK position	ON
KEYLESS LOCK	"LOCK" button of key fob is not pressed	OFF
	"LOCK" button of key fob is pressed	ON
KEYLESS UNLOCK	"UNLOCK" button of key fob is not pressed	OFF
	"UNLOCK" button of key fob is pressed	ON
ACC ON SW	Ignition switch OFF	OFF
	Ignition switch ACC or ON	ON
REAR DEF SW	Rear window defogger switch OFF	OFF
	Rear window defogger switch ON	ON
LIGHT SW 1ST	Lighting switch OFF	OFF
	Lighting switch 1ST	ON
BUCKLE SW	The seat belt (driver side) is unfastened. [Seat belt switch (driver side) OFF]	OFF
	The seat belt (driver side) is fastened. [Seat belt switch (driver side) ON]	ON
KEYLESS PANIC	PANIC button of key fob is not pressed	OFF
	PANIC button of key fob is pressed	ON
KEYLESS TRUNK	NOTE: The item is indicated, but not monitored.	OFF

BCM (BODY CONTROL MODULE)

< ECU DIAGNOSIS >

Monitor Item	Condition	Value/Status
TRNK OPN MNTR	NOTE: The item is indicated, but not monitored.	OFF
RKE LCK-UNLCK	LOCK/UNLOCK button of key fob is not pressed and held simultaneously	OFF
	LOCK/UNLOCK button of key fob is pressed and held simultaneously	ON
RKE KEEP UNLK	UNLOCK button of key fob is not pressed	OFF
	UNLOCK button of key fob is pressed and held	ON
HI BEAM SW	Lighting switch OFF	OFF
	Lighting switch HI	ON
HEAD LAMP SW 1	Lighting switch OFF	OFF
	Lighting switch 2ND	ON
HEAD LAMP SW 2	Lighting switch OFF	OFF
	Lighting switch 2ND	ON
AUTO LIGHT SW	Lighting switch OFF	OFF
	Lighting switch AUTO	ON
PASSING SW	Other than lighting switch PASS	OFF
	Lighting switch PASS	ON
FR FOG SW	Front fog lamp switch OFF	OFF
	Front fog lamp switch ON	ON
RR FOG SW	NOTE: The item is indicated, but not monitored.	OFF
TURN SIGNAL R	Turn signal switch OFF	OFF
	Turn signal switch RH	ON
TURN SIGNAL L	Turn signal switch OFF	OFF
	Turn signal switch LH	ON
CARGO LAMP SW	Cargo lamp switch OFF	OFF
	Cargo lamp switch ON	ON
OPTICAL SENSOR	Bright outside vehicle	5V
	Dark outside vehicle	0V
IGN SW CAN	Ignition switch OFF or ACC	OFF
	Ignition switch ON	ON
FR WIPER HI	Front wiper switch OFF	OFF
	Front wiper switch HI	ON
FR WIPER LOW	Front wiper switch OFF	OFF
	Front wiper switch LO	ON
FR WIPER INT	Front wiper switch OFF	OFF
	Front wiper switch INT	ON
FR WASHER SW	Front washer switch OFF	OFF
	Front washer switch ON	ON
INT VOLUME	Wiper intermittent dial is in a dial position 1 - 7	1 - 7
FR WIPER STOP	Any position other than front wiper stop position	OFF
	Front wiper stop position	ON
VEHICLE SPEED	While driving	Equivalent to speedometer reading
RR WIPER ON	NOTE: The item is indicated, but not monitored.	OFF

BCM (BODY CONTROL MODULE)

< ECU DIAGNOSIS >

Monitor Item	Condition	Value/Status	
RR WIPER INT	NOTE: The item is indicated, but not monitored.	OFF	A
RR WASHER SW	NOTE: The item is indicated, but not monitored.	OFF	B
RR WIPER STOP	NOTE: The item is indicated, but not monitored.	OFF	
RR WIPER STP2	NOTE: The item is indicated, but not monitored.	OFF	C
H/L WASH SW	NOTE: The item is indicated, but not monitored.	OFF	D
HAZARD SW	Hazard switch OFF	OFF	
	Hazard switch ON	ON	E
BRAKE SW	Brake pedal is not depressed	OFF	
	Brake pedal is depressed	ON	F
FAN ON SIG	Blower fan motor switch OFF	OFF	
	Blower fan motor switch ON (other than OFF)	ON	G
AIR COND SW	Compressor ON is not requested from auto amp. (A/C indicator OFF, blower fan motor switch OFF or etc.)	OFF	
	Compressor ON is requested from auto amp. (A/C indicator ON and blower fan motor switch ON).	ON	H
TRNK OPNR SW	NOTE: The item is indicated, but not monitored.	OFF	I
TRUNK CYL SW	NOTE: The item is indicated, but not monitored.	OFF	J
HOOD SW	NOTE: The item is indicated, but not monitored.	OFF	
OIL PRESS SW	• Ignition switch OFF or ACC • Engine running	OFF	K
	Ignition switch ON	ON	L
AIR PRESS FL	Ignition switch ON (Only when the signal from the transmitter is received)	Air pressure of front LH tire	M
AIR PRESS FR	Ignition switch ON (Only when the signal from the transmitter is received)	Air pressure of front RH tire	
AIR PRESS RR	Ignition switch ON (Only when the signal from the transmitter is received)	Air pressure of rear RH tire	
AIR PRESS RL	Ignition switch ON (Only when the signal from the transmitter is received)	Air pressure of rear LH tire	
ID REGST FL1	ID of front LH tire transmitter is registered	DONE	MWI
	ID of front LH tire transmitter is not registered	YET	
ID REGST FR1	ID of front RH tire transmitter is registered	DONE	O
	ID of front RH tire transmitter is not registered	YET	
ID REGST RR1	ID of rear RH tire transmitter is registered	DONE	P
	ID of rear RH tire transmitter is not registered	YET	
ID REGST RL1	ID of rear LH tire transmitter is registered	DONE	
	ID of rear LH tire transmitter is not registered	YET	
WARNING LAMP	Tire pressure indicator OFF	OFF	
	Tire pressure indicator ON	ON	
BUZZER	Tire pressure warning alarm is not sounding	OFF	
	Tire pressure warning alarm is sounding	ON	

BCM (BODY CONTROL MODULE)

< ECU DIAGNOSIS >

Terminal Layout

INFOID:000000004459297

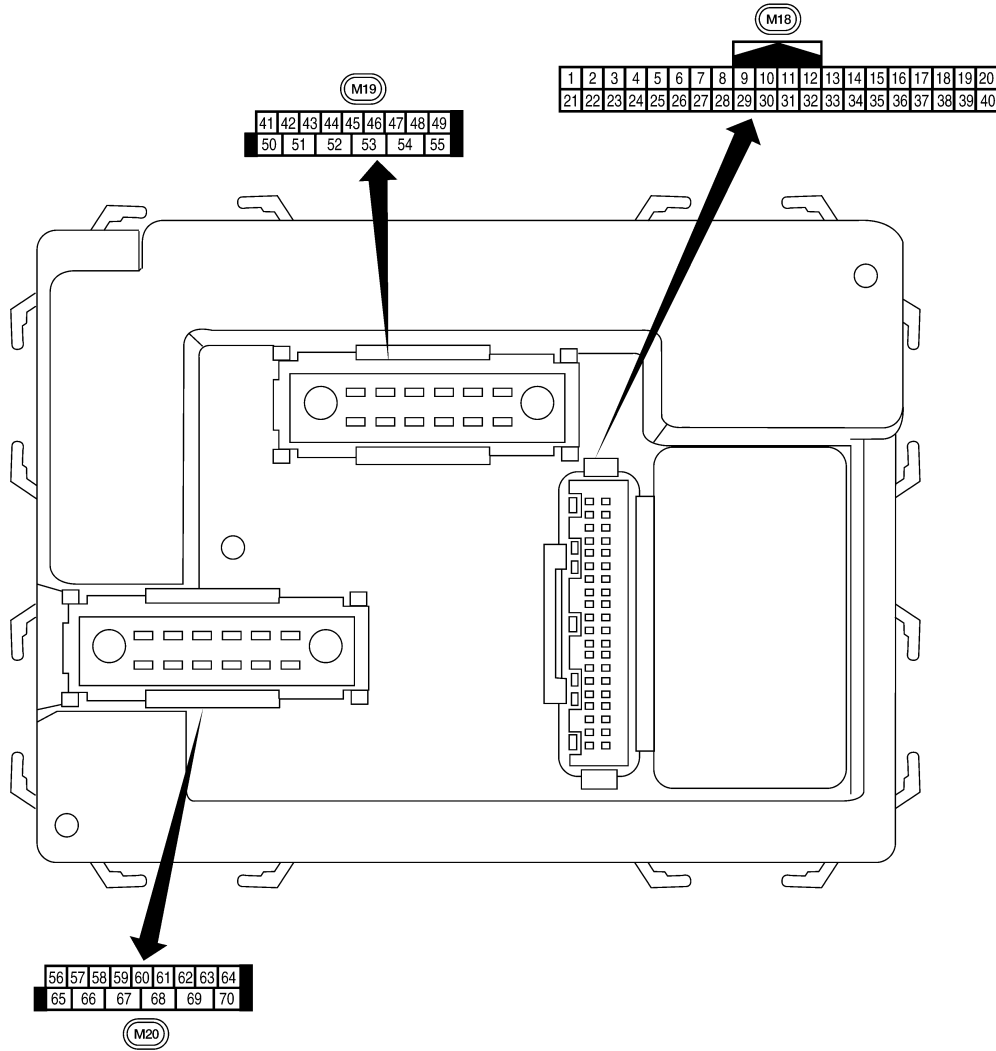

Physical Values

L1IA2443E

INFOID:000000004459298

BCM (BODY CONTROL MODULE)

< ECU DIAGNOSIS >

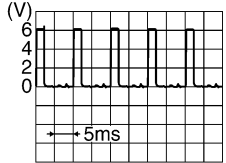
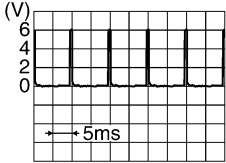
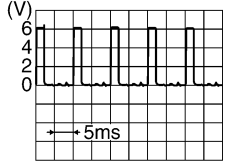
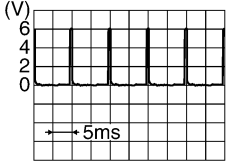
Terminal	Wire color	Item	Signal input/output	Measuring condition		Reference value or waveform (Approx.)
				Ignition switch	Operation or condition	
1	BR	Ignition keyhole illumination	Output	OFF	Door is locked (SW OFF)	Battery voltage
					Door is unlocked (SW ON)	0V
2	P	Combination switch input 5	Input	ON	Lighting, turn, wiper OFF Wiper dial position 4	 <p style="text-align: right; font-size: small;">SKIA5291E</p>
3	SB	Combination switch input 4	Input	ON	Lighting, turn, wiper OFF Wiper dial position 4	 <p style="text-align: right; font-size: small;">SKIA5292E</p>
4	V	Combination switch input 3	Input	ON	Lighting, turn, wiper OFF Wiper dial position 4	 <p style="text-align: right; font-size: small;">SKIA5291E</p>
5	L	Combination switch input 2	Input	ON	Lighting, turn, wiper OFF Wiper dial position 4	 <p style="text-align: right; font-size: small;">SKIA5292E</p>
6	R	Combination switch input 1				
7	GR	Front door lock assembly LH (key cylinder switch) unlock	Input	OFF	ON (open, 2nd turn)	Momentary 1.5V
8	SB	Front door lock assembly LH (key cylinder switch) lock			OFF (closed)	0V
			On (open)	Momentary 1.5V		
9	Y	Rear window defogger switch	Input	ON	Rear window defogger switch ON	0V
					Rear window defogger switch OFF	5V
11	G/B	Ignition switch (ACC or ON)	Input	ACC or ON	Ignition switch ACC or ON	Battery voltage
12	LG	Front door switch RH (All)	Input	OFF	ON (open)	0V
		Rear door switch upper RH (King Cab)			OFF (closed)	Battery voltage
		Rear door switch lower RH (King Cab)				

A
B
C
D
E
F
G
H
I
J
K
L
M
N
O
P

MWI

BCM (BODY CONTROL MODULE)

< ECU DIAGNOSIS >

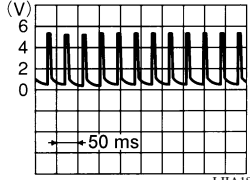
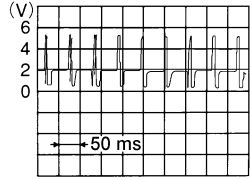
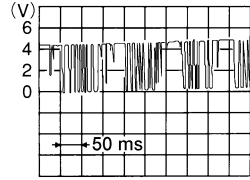
Terminal	Wire color	Item	Signal input/output	Measuring condition		Reference value or waveform (Approx.)
				Ignition switch	Operation or condition	
13	L	Rear door switch RH (Crew Cab)	Input	OFF	ON (open)	0V
					OFF (closed)	Battery voltage
15	W	Tire pressure warning check connector	Input	OFF	—	5V
18	BR	Remote keyless entry receiver (Ground)	Output	OFF	—	0V
19	V	Remote keyless entry receiver (power supply)	Output	OFF	Ignition switch OFF	 <small>LIIA1893E</small>
20	G	Remote keyless entry receiver signal (Signal)	Input	OFF	Stand-by (keyfob buttons released)	 <small>LIIA1894E</small>
					When remote keyless entry receiver receives signal from keyfob (keyfob buttons pressed)	 <small>LIIA1895E</small>
21	GR	NATS antenna amp.	Input	OFF → ON	Ignition switch (OFF → ON)	Just after turning ignition switch ON: Pointer of tester should move.
23	G	Security indicator lamp	Output	OFF	Goes OFF → illuminates (Every 2.4 seconds)	Battery voltage → 0V
25	BR	NATS antenna amp.	Input	OFF → ON	Ignition switch (OFF → ON)	Just after turning ignition switch ON: Pointer of tester should move.
27	W	Compressor ON signal	Input	ON	A/C switch OFF	5V
					A/C switch ON	0V
28	R	Front blower monitor	Input	ON	Front blower motor OFF	Battery voltage
					Front blower motor ON	0V
29	G	Hazard switch	Input	OFF	ON	0V
					OFF	5V
31	GR	Cargo lamp switch	Input	OFF	ON	0V
					OFF	Battery voltage

BCM (BODY CONTROL MODULE)

< ECU DIAGNOSIS >

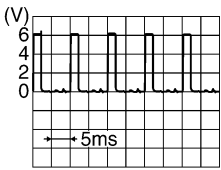
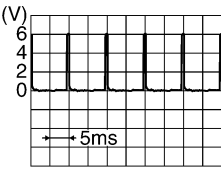
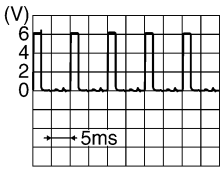
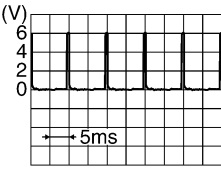
Terminal	Wire color	Item	Signal input/output	Measuring condition		Reference value or waveform (Approx.)
				Ignition switch	Operation or condition	
32	O	Combination switch output 5	Output	ON	Lighting, turn, wiper OFF Wiper dial position 4	 <p style="text-align: right; font-size: small;">SKIA5291E</p>
33	GR	Combination switch output 4	Output	ON	Lighting, turn, wiper OFF Wiper dial position 4	 <p style="text-align: right; font-size: small;">SKIA5292E</p>
34	G	Combination switch output 3	Output	ON	Lighting, turn, wiper OFF Wiper dial position 4	 <p style="text-align: right; font-size: small;">SKIA5291E</p>
35	BR	Combination switch output 2	Output	ON	Lighting, turn, wiper OFF Wiper dial position 4	 <p style="text-align: right; font-size: small;">SKIA5292E</p>
36	LG	Combination switch output 1				
37	B	Key switch	Input	OFF	Key inserted	Battery voltage
					Key removed	0V
38	W/R	Ignition switch (ON)	Input	ON	—	Battery voltage
39	L	CAN-H	—	—	—	—
40	P	CAN-L	—	—	—	—
45	V	Lock switch	Input	OFF	ON (lock)	0V
					OFF	Battery voltage
46	LG	Unlock switch	Input	OFF	ON (unlock)	0V
					OFF	Battery voltage
47	GR	Front door switch LH (All)	Input	OFF	ON (open)	0V
		Rear door switch upper LH (King Cab)			OFF (closed)	Battery voltage
		Rear door switch lower LH (King Cab)				
48	P	Rear door switch LH (Crew Cab)	Input	OFF	ON (open)	0V
					OFF (closed)	Battery voltage
50	P	Cargo lamp	Output	OFF	Any door open (ON)	0V
					All doors closed (OFF)	Battery voltage

A
B
C
D
E
F
G
H
I
J
K
L
M
N
O
P

MWI

BCM (BODY CONTROL MODULE)

< ECU DIAGNOSIS >

Terminal	Wire color	Item	Signal input/output	Measuring condition		Reference value or waveform (Approx.)
				Ignition switch	Operation or condition	
51	G	Trailer turn signal (right)	Output	ON	Turn right ON	<p style="text-align: right; font-size: small;">SKIA3009J</p>
52	V	Trailer turn signal (left)	Output	ON	Turn left ON	<p style="text-align: right; font-size: small;">SKIA3009J</p>
56	V	Battery saver output	Output	OFF	30 minutes after ignition switch is turned OFF	0V
				ON	—	Battery voltage
57	R/Y	Battery power supply	Input	—	—	Battery voltage
58	W	Optical sensor	Input	ON	When optical sensor is illuminated	3.1V or more
					When optical sensor is not illuminated	0.6V or less
59	GR	Front door lock assembly LH (unlock)	Output	OFF	OFF (neutral)	0V
					ON (unlock)	Battery voltage
60	LG	Turn signal (left)	Output	ON	Turn left ON	<p style="text-align: right; font-size: small;">SKIA3009J</p>
61	G	Turn signal (right)	Output	ON	Turn right ON	<p style="text-align: right; font-size: small;">SKIA3009J</p>
63	BR	Interior room/map lamp	Output	OFF	Any door switch ON (open)	0V
					OFF (closed)	Battery voltage
65	V	All door lock actuators (lock)	Output	OFF	OFF (neutral)	0V
					ON (lock)	Battery voltage
66	L	Front door lock actuator RH, rear door lock actuators LH/RH (unlock)	Output	OFF	OFF (neutral)	0V
					ON (unlock)	Battery voltage
67	B	Ground	Input	ON	—	0V

BCM (BODY CONTROL MODULE)

< ECU DIAGNOSIS >

Terminal	Wire color	Item	Signal input/output	Measuring condition		Reference value or waveform (Approx.)
				Ignition switch	Operation or condition	
68	O	Power window power supply (RAP)	Output	—	Ignition switch ON	Battery voltage
					Within 45 seconds after ignition switch OFF	Battery voltage
					More than 45 seconds after ignition switch OFF	0V
					When front door LH or RH is open or power window timer operates	0V
69	P	Power window power supply (BAT)	Output	OFF	—	Battery voltage
70	W	Battery power supply	Input	OFF	—	Battery voltage

A
B
C
D
E
F
G
H
I
J
K
L
M
N
O
P

MWI

BCM (BODY CONTROL MODULE)

< ECU DIAGNOSIS >

Wiring Diagram

INFOID:000000004459299

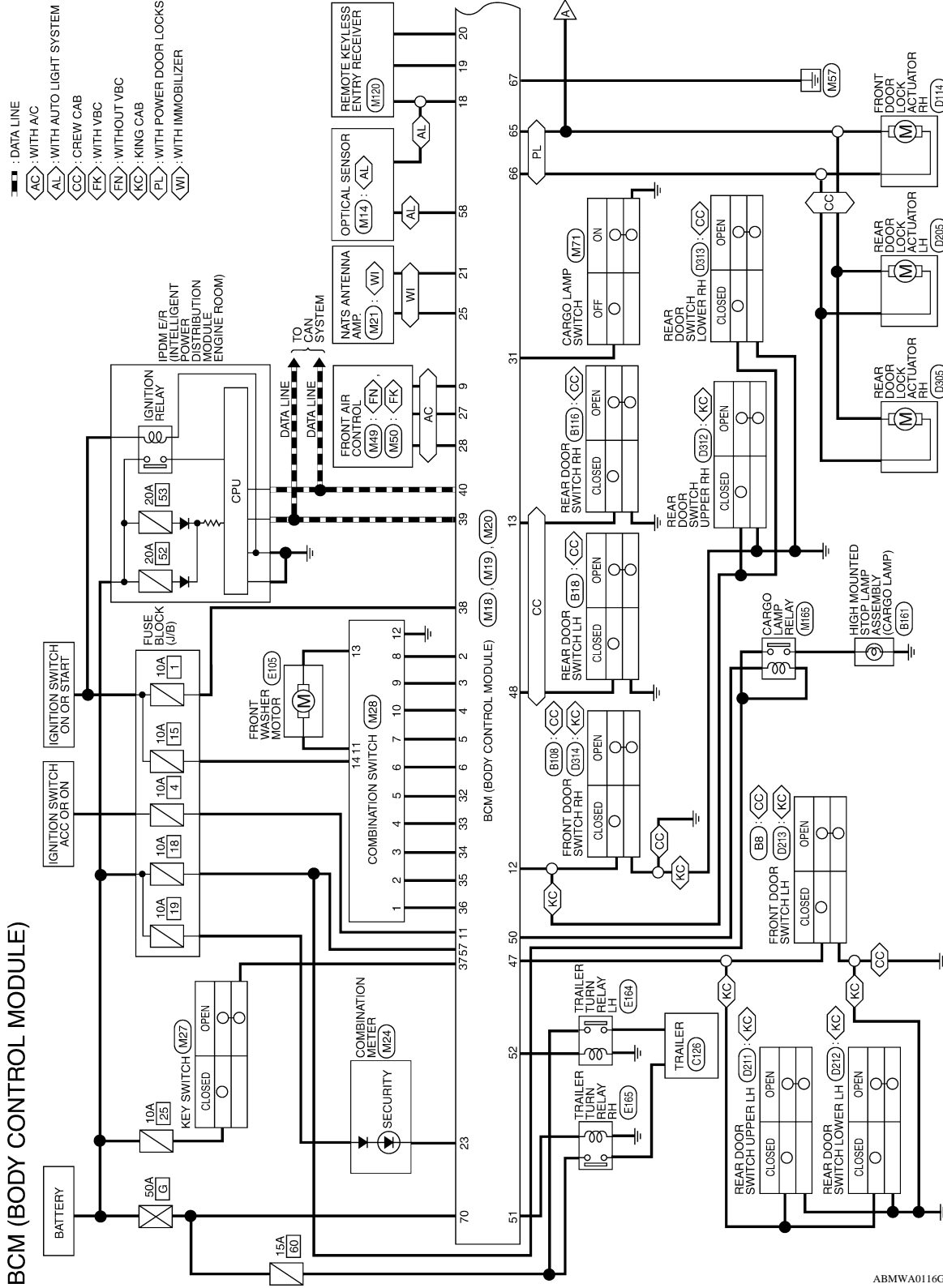

ABMWA0116GI

BCM (BODY CONTROL MODULE)

< ECU DIAGNOSIS >

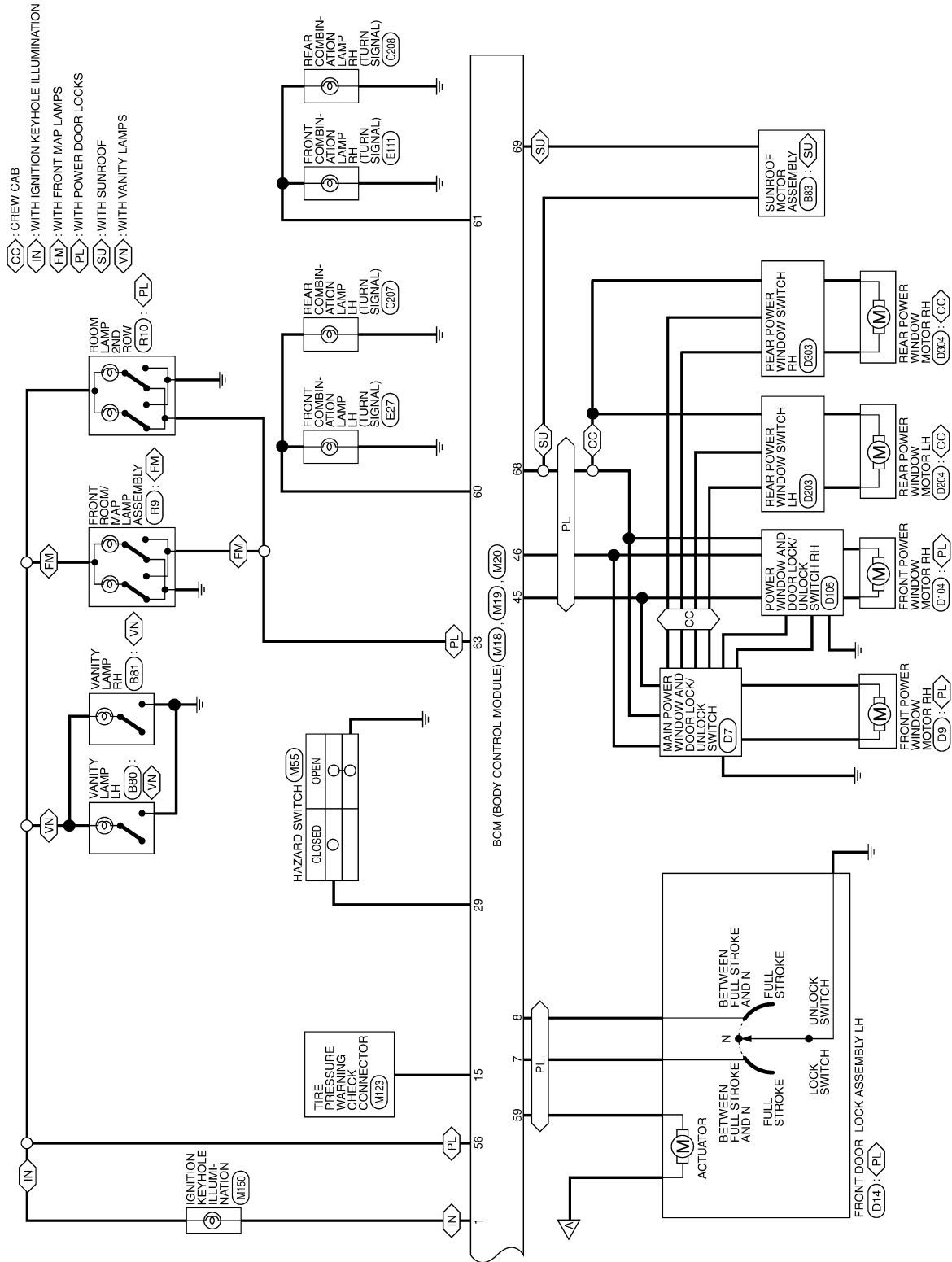

ABMWA0117G1

A
B
C
D
E
F
G
H
I
J
K
L
M
N
O
P



BCM (BODY CONTROL MODULE)

< ECU DIAGNOSIS >

BCM (BODY CONTROL MODULE) CONNECTORS

Connector No.	M18
Connector Name	BCM (BODY CONTROL MODULE)
Connector Color	WHITE



1	2	3	4	5	6	7	8	9	10	11	12	13	14	15	16	17	18	19	20
21	22	23	24	25	26	27	28	29	30	31	32	33	34	35	36	37	38	39	40

Terminal No.	Color of Wire	Signal Name
1	BR	KEY RING OUTPUT
2	P	INPUT 5
3	SB	INPUT 4
4	V	INPUT 3
5	L	INPUT 2
6	R	INPUT 1
7	GR	KEY CYLINDER UNLOCK SW
8	SB	KEY CYLINDER LOCK SW
9	Y	RR DEFOGGER SW
10	-	-
11	G/B	ACC. SW
12	LG	DOOR SW (AS)
13	L	DOOR SW (RR)
14	-	-
15	W	TPMS MODE TRIGGER SW
16	-	-
17	-	-
18	BR	KEYLESS & AUTO LIGHT SENSOR GND
19	V	KEYLESS TUNER POWER SUPPLY OUTPUT

Terminal No.	Color of Wire	Signal Name
20	G	KEYLESS TUNER SIGNAL
21	GR	IMMOBILIZER ANTENNA SIGNAL (CLOCK)
22	-	-
23	G	SECURITY INDICATOR OUTPUT
24	-	-
25	BR	IMMOBILIZER ANTENNA SIGNAL (RX, TX)
26	-	-
27	W	AIRCON SW
28	R	BLOWER FAN SW
29	G	HAZARD SW
30	-	-
31	GR	CARGO LAMP SW
32	O	OUTPUT 5
33	GR	OUTPUT 4
34	G	OUTPUT 3
35	BR	OUTPUT 2
36	LG	OUTPUT 1
37	B	KEY SW
38	W/R	IGN SW
39	L	CAN-H
40	P	CAN-L

Connector No.	M19
Connector Name	BCM (BODY CONTROL MODULE)
Connector Color	WHITE



41	42	43	44	45	46	47	48	49
50	51	52	53	54	55			

Terminal No.	Color of Wire	Signal Name
41	-	-
42	-	-
43	-	-
44	-	-
45	V	CDL LOCK SW
46	LG	CDL UNLOCK SW
47	GR	DOOR SW (DR)
48	P	DOOR SW (RL)
49	-	-
50	P	CARGO LAMP OUTPUT
51	G	TRAILER FLASHER OUTPUT (RIGHT)
52	V	TRAILER FLASHER OUTPUT (LEFT)
53	-	-
54	-	-
55	-	-

ABMIA0315GB

BCM (BODY CONTROL MODULE)

< ECU DIAGNOSIS >

A
B
C
D
E
F
G
H
I
J
K
L
M
N
O
P

Connector No.	M28
Connector Name	COMBINATION SWITCH
Connector Color	WHITE

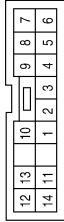

Terminal No.	Color of Wire	Signal Name
1	LG	INPUT 1
2	BR	INPUT 2
3	G	INPUT 3
4	GR	INPUT 4
5	O	INPUT 5
6	R	OUTPUT 1
7	L	OUTPUT 2
8	P	OUTPUT 5
9	SB	OUTPUT 4
10	V	OUTPUT 3
11	O	WASH FR (-) RR (+)
12	B	GND
13	L	WASH FR (-) RR (-)
14	W	IGN

Connector No.	M20
Connector Name	BCM (BODY CONTROL MODULE)
Connector Color	BLACK



Terminal No.	Color of Wire	Signal Name
56	V	BATTERY SAVER OUTPUT
57	R/Y	BAT (FUSE)
58	W	AUTO LIGHT SENSOR INPUT 2
59	GR	DOOR UNLOCK OUTPUT (DR)
60	LG	FLASHER OUTPUT (LEFT)
61	G	FLASHER OUTPUT (RIGHT)
62	-	-
63	BR	ROOM LAMP OUTPUT
64	-	-
65	V	DOOR LOCK OUTPUT (ALL)
66	L	DOOR UNLOCK OUTPUT (OTHER)
67	B	GND (POWER)
68	O	POWER WINDOW POWER SUPPLY OUTPUT (LINKED TO RAP)
69	P	POWER WINDOW POWER SUPPLY OUTPUT (BAT)
70	W	BAT (F/L)



Fail Safe

ABMIA0316GB

INFOID:000000004459300

Fail-safe index

BCM performs fail-safe control when any DTC listed below is detected.

BCM (BODY CONTROL MODULE)

< ECU DIAGNOSIS >

Display contents of CONSULT	Fail-safe	Cancellation
U1000: CAN COMM CIRCUIT	Inhibit engine cranking	When the BCM re-establishes communication with the other modules.
U1010: CONTROL UNIT (CAN)	Inhibit engine cranking	When the BCM re-start communicating with the other modules.

DTC Inspection Priority Chart

INFOID:000000004459301

If some DTCs are displayed at the same time, perform inspections one by one based on the following priority chart.

Priority	DTC
1	<ul style="list-style-type: none"> • U1000: CAN COMM CIRCUIT • U1010: CONTROL UNIT (CAN)
2	<ul style="list-style-type: none"> • B2190: NATS ANTENNA AMP • B2191: DIFFERENCE OF KEY • B2192: ID DISCORD BCM-ECM • B2193: CHAIN OF BCM-ECM
3	<ul style="list-style-type: none"> • C1729: VHCL SPEED SIG ERR • C1735: IGNITION SIGNAL
4	<ul style="list-style-type: none"> • C1704: LOW PRESSURE FL • C1705: LOW PRESSURE FR • C1706: LOW PRESSURE RR • C1707: LOW PRESSURE RL • C1708: [NO DATA] FL • C1709: [NO DATA] FR • C1710: [NO DATA] RR • C1711: [NO DATA] RL • C1712: [CHECKSUM ERR] FL • C1713: [CHECKSUM ERR] FR • C1714: [CHECKSUM ERR] RR • C1715: [CHECKSUM ERR] RL • C1716: [PRESSDATA ERR] FL • C1717: [PRESSDATA ERR] FR • C1718: [PRESSDATA ERR] RR • C1719: [PRESSDATA ERR] RL • C1720: [CODE ERR] FL • C1721: [CODE ERR] FR • C1722: [CODE ERR] RR • C1723: [CODE ERR] RL • C1724: [BATT VOLT LOW] FL • C1725: [BATT VOLT LOW] FR • C1726: [BATT VOLT LOW] RR • C1727: [BATT VOLT LOW] RL

DTC Index

INFOID:000000004459302

NOTE:

- Details of time display
- CRNT: Displays when there is a malfunction now or after returning to the normal condition until turning ignition switch OFF → ON again.
- 1 - 39: Displayed if any previous malfunction is present when current condition is normal. It increases like 1 → 2 → 3...38 → 39 after returning to the normal condition whenever ignition switch OFF → ON. The counter remains at 39 even if the number of cycles exceeds it. It is counted from 1 again when turning ignition switch OFF → ON after returning to the normal condition if the malfunction is detected again.

BCM (BODY CONTROL MODULE)

< ECU DIAGNOSIS >

CONSULT display	Fail-safe	Tire pressure monitor warning lamp ON	Reference page
No DTC is detected. further testing may be required.	—	—	—
U1000: CAN COMM CIRCUIT	—	—	BCS-30
U1010: CONTROL UNIT (CAN)	—	—	BCS-31
B2190: NATS ANTENA AMP	—	—	SEC-18
B2191: DIFFERENCE OF KEY	—	—	SEC-21
B2192: ID DISCORD BCM-ECM	—	—	SEC-22
B2193: CHAIN OF BCM-ECM	—	—	SEC-24
C1708: [NO DATA] FL	—	—	WT-14
C1709: [NO DATA] FR	—	—	WT-14
C1710: [NO DATA] RR	—	—	WT-14
C1711: [NO DATA] RL	—	—	WT-14
C1712: [CHECKSUM ERR] FL	—	—	WT-16
C1713: [CHECKSUM ERR] FR	—	—	WT-16
C1714: [CHECKSUM ERR] RR	—	—	WT-16
C1715: [CHECKSUM ERR] RL	—	—	WT-16
C1716: [PRESSDATA ERR] FL	—	—	WT-18
C1717: [PRESSDATA ERR] FR	—	—	WT-18
C1718: [PRESSDATA ERR] RR	—	—	WT-18
C1719: [PRESSDATA ERR] RL	—	—	WT-18
C1720: [CODE ERR] FL	—	—	WT-16
C1721: [CODE ERR] FR	—	—	WT-16
C1722: [CODE ERR] RR	—	—	WT-16
C1723: [CODE ERR] RL	—	—	WT-16
C1724: [BATT VOLT LOW] FL	—	—	WT-16
C1725: [BATT VOLT LOW] FR	—	—	WT-16
C1726: [BATT VOLT LOW] RR	—	—	WT-16
C1727: [BATT VOLT LOW] RL	—	—	WT-16
C1729: VHCL SPEED SIG ERR	—	—	WT-19
C1735: IGNITION SIGNAL	—	—	—

A
B
C
D
E
F
G
H
I
J
K
L
M
O
P

MWI

IPDM E/R (INTELLIGENT POWER DISTRIBUTION MODULE ENGINE ROOM)

< ECU DIAGNOSIS >

IPDM E/R (INTELLIGENT POWER DISTRIBUTION MODULE ENGINE ROOM)

Reference Value

INFOID:000000004459303

VALUES ON THE DIAGNOSIS TOOL

Monitor Item	Condition		Value/Status
MOTOR FAN REQ	Engine idle speed	Changes depending on engine coolant temperature, air conditioner operation status, vehicle speed, etc.	0 - 100 %
A/C COMP REQ	A/C switch OFF		OFF
	A/C switch ON		ON
TAIL&CLR REQ	Lighting switch OFF		OFF
	Lighting switch 1ST, 2ND, HI or AUTO (Light is illuminated)		ON
HL LO REQ	Lighting switch OFF		OFF
	Lighting switch 2ND HI or AUTO (Light is illuminated)		ON
HL HI REQ	Lighting switch OFF		OFF
	Lighting switch HI		ON
FR FOG REQ	Lighting switch 2ND	Front fog lamp switch OFF	OFF
		Front fog lamp switch ON	ON
H L WASHER REQ	NOTE: This item is displayed, but cannot be monitored.		OFF
FR WIP REQ	Ignition switch ON	Front wiper switch OFF	STOP
		Front wiper switch INT	1LOW
		Front wiper switch LO	LOW
		Front wiper switch HI	HI
WIP AUTO STOP	Ignition switch ON	Front wiper stop position	STOP P
		Any position other than front wiper stop position	ACT P
WIP PROT	Ignition switch ON	Front wiper operates normally	OFF
		Front wiper stops at fail-safe operation	BLOCK
ST RLY REQ	Ignition switch OFF or ACC		OFF
	Ignition switch START		ON
IGN RLY	Ignition switch OFF or ACC		OFF
	Ignition switch ON		ON
RR DEF REQ	Rear defogger switch OFF		OFF
	Rear defogger switch ON		ON
OIL P SW	Ignition switch OFF, ACC or engine running		OPEN
	Ignition switch ON		CLOSE
DTRL REQ	NOTE: This item is displayed, but cannot be monitored.		OFF
HOOD SW	NOTE: This item is displayed, but cannot be monitored.		OFF

IPDM E/R (INTELLIGENT POWER DISTRIBUTION MODULE ENGINE ROOM)

< ECU DIAGNOSIS >

Monitor Item	Condition	Value/Status
THFT HRN REQ	Not operated	OFF
	<ul style="list-style-type: none">• Panic alarm is activated• Horn is activated with VEHICLE SECURITY (THEFT WARNING) SYSTEM	ON
HORN CHIRP	Not operated	OFF
	Door locking with keyfob (horn chirp mode)	ON

A
B
C
D
E
F
G
H
I
J
K
L
M
O
P

MWI

IPDM E/R (INTELLIGENT POWER DISTRIBUTION MODULE ENGINE ROOM)

< ECU DIAGNOSIS >

Terminal Layout

INFOID:000000004459304

TERMINAL LAYOUT

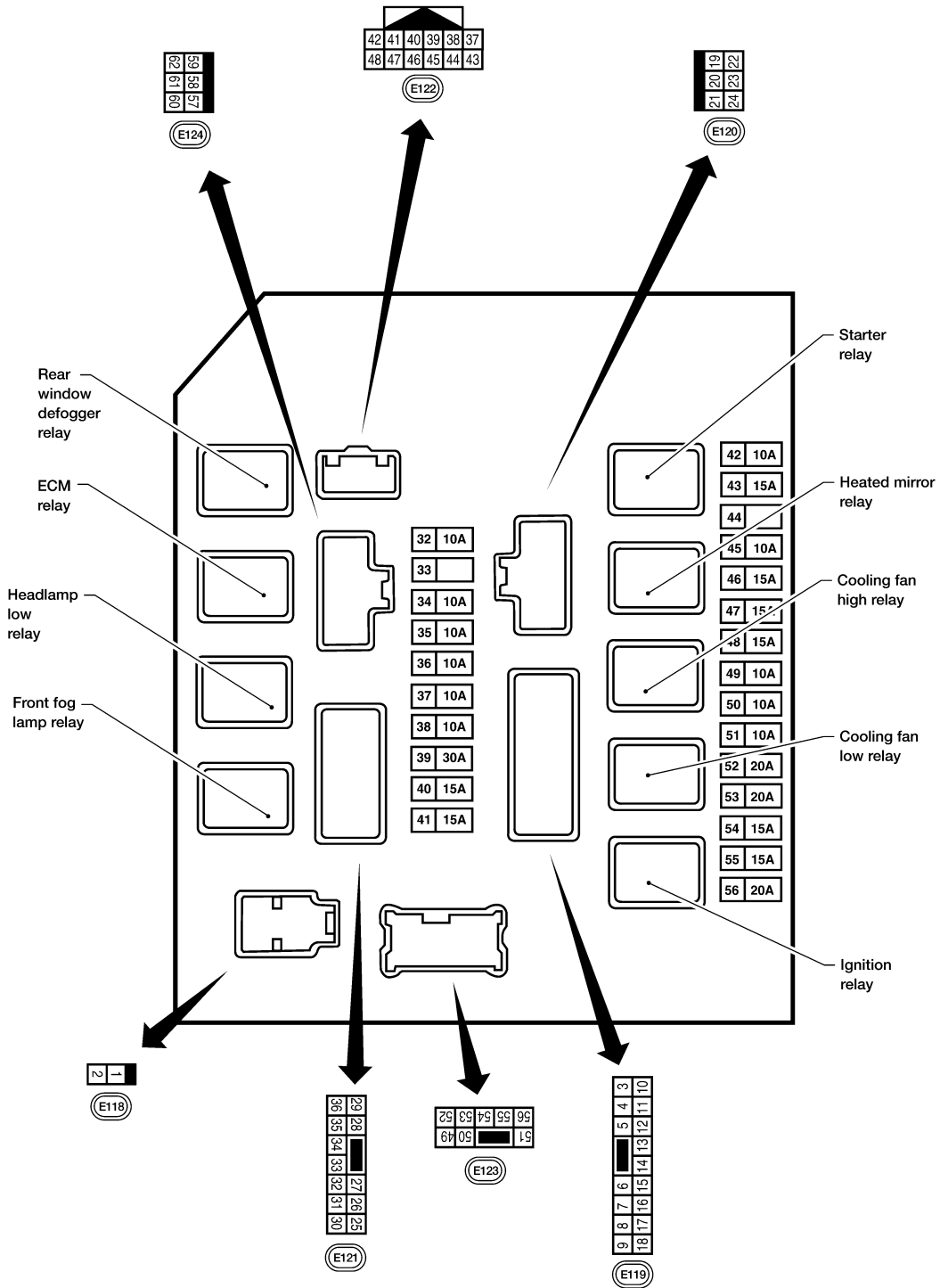

Physical Values

PHYSICAL VALUES

WKIA5883E

INFOID:000000004459305

IPDM E/R (INTELLIGENT POWER DISTRIBUTION MODULE ENGINE ROOM)

< ECU DIAGNOSIS >

Terminal	Wire color	Signal name	Signal input/output	Measuring condition		Reference value (Approx.)
				Ignition switch	Operation or condition	
1	W	Battery power supply	Input	OFF	—	Battery voltage
2	R	Battery power supply	Input	OFF	—	Battery voltage
3	G	ECM relay	Output	—	Ignition switch ON or START	Battery voltage
					Ignition switch OFF or ACC	0V
4	P	ECM relay	Output	—	Ignition switch ON or START	Battery voltage
					Ignition switch OFF or ACC	0V
6	V	Throttle control motor relay	Output	—	Ignition switch ON or START	Battery voltage
					Ignition switch OFF or ACC	0V
7	BR	ECM relay control	Input	—	Ignition switch ON or START	0V
					Ignition switch OFF or ACC	Battery voltage
8	W/R	Fuse 54	Output	—	Ignition switch ON or START	Battery voltage
					Ignition switch OFF or ACC	0V
10	R/B	Fuse 45	Output	ON	Daytime light system active	0V
					Daytime light system inactive	Battery voltage
11	Y	A/C compressor	Output	ON or START	A/C switch ON or defrost A/C switch	Battery voltage
					A/C switch OFF or defrost A/C switch	0V
12	W/G	Ignition switch supplied power	Input	—	OFF or ACC	0V
					ON or START	Battery voltage
13	R	Fuel pump relay	Output	—	Ignition switch ON or START	Battery voltage
					Ignition switch OFF or ACC	0V
14	W/G	Fuse 49	Output	—	Ignition switch ON or START	Battery voltage
					Ignition switch OFF or ACC	0V
15	W/R	Fuse 50 (ABS)	Output	—	Ignition switch ON or START	Battery voltage
					Ignition switch OFF or ACC	0V
16	W/G	Fuse 51	Output	—	Ignition switch ON or START	Battery voltage
					Ignition switch OFF or ACC	0V
17	W/G	Fuse 55	Output	—	Ignition switch ON or START	Battery voltage
					Ignition switch OFF or ACC	0V
19	W	Starter motor	Output	START	—	Battery voltage
20	BR	Cooling fan motor (low)	Output	ON or START	—	Battery voltage
21	GR	Ignition switch supplied power	Input	—	OFF or ACC	0V
					START	Battery voltage
22	G	Battery power supply	Output	OFF	—	Battery voltage
23	LG	Door mirror defogger output signal	Output	—	When rear defogger switch is ON	Battery voltage
					When raker defogger switch is OFF	0V

A
B
C
D
E
F
G
H
I
J
K
L
M
O
P

MWI

IPDM E/R (INTELLIGENT POWER DISTRIBUTION MODULE ENGINE ROOM)

< ECU DIAGNOSIS >

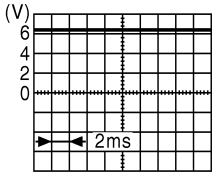
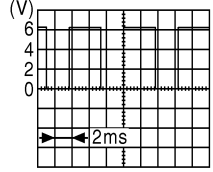
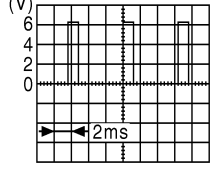
Terminal	Wire color	Signal name	Signal input/output	Measuring condition		Reference value (Approx.)
				Ignition switch	Operation or condition	
24	P	Cooling fan motor (high)	Output	—	Conditions correct for cooling fan operation	Battery voltage
					Conditions not correct for cooling fan operation	0V
27	W	Fuse 38	Output	—	Ignition switch ON or START	Battery voltage
					Ignition switch OFF or ACC	0V
28	R	LH front parking and front side marker lamp	Output	OFF	Lighting switch 1st position OFF	0V
					Lighting switch 1st position ON	Battery voltage
29	G	Trailer tow relay	Output	ON	Lighting switch 1st position OFF	0V
					Lighting switch 1st position ON	Battery voltage
30	R/B	Fuse 53	Output	—	Ignition switch ON or START	Battery voltage
					Ignition switch OFF or ACC	0V
32	GR	Wiper low speed signal	Output	ON or START	Wiper switch OFF	Battery voltage
					Wiper switch LO or INT	0V
35	L	Wiper high speed signal	Output	ON or START	Wiper switch OFF, LO, INT	Battery voltage
					Wiper switch HI	0V
37	Y	Power generation command signal	Output	—	Ignition switch ON	 <p style="text-align: right;">JPMLA0001GB</p> <p style="text-align: center;">6.3 V</p>
					40% is set on "Active test," "ALTERNATOR DUTY" of "ENGINE"	 <p style="text-align: right;">JPMLA0002GB</p> <p style="text-align: center;">3.8 V</p>
					40% is set on "Active test," "ALTERNATOR DUTY" of "ENGINE"	 <p style="text-align: right;">JPMLA0003GB</p> <p style="text-align: center;">1.4 V</p>
38	B	Ground	Input	—	—	0V
39	L	CAN-H	—	ON	—	—
40	P	CAN-L	—	ON	—	—
42	GR	Oil pressure switch	Input	—	Engine running	Battery voltage
					Engine stopped	0V

IPDM E/R (INTELLIGENT POWER DISTRIBUTION MODULE ENGINE ROOM)

< ECU DIAGNOSIS >

Terminal	Wire color	Signal name	Signal input/output	Measuring condition		Reference value (Approx.)
				Ignition switch	Operation or condition	
43	G	Wiper auto stop signal	Input	ON or START	Wiper switch OFF, LO, INT	Battery voltage
44	R	Daytime light relay control (Canada only)	Input	ON	Daytime light system active	0V
					Daytime light system inactive	Battery voltage
45	LG	Horn relay control	Input	ON	When door locks are operated using keyfob (OFF → ON)*	Battery voltage → 0V
46	V	Fuel pump relay control	Input	—	Ignition switch ON or START	0V
					Ignition switch OFF or ACC	Battery voltage
47	O	Throttle control motor relay control	Input	—	Ignition switch ON or START	0V
					Ignition switch OFF or ACC	Battery voltage
48	R	Starter relay (inhibit switch)	Input	ON or START	Selector lever in "P" or "N"	0V
					Selector lever any other position	Battery voltage
49	GR	Front RH parking and front side marker lamp	Output	OFF	Lighting switch 1st position OFF	0V
					ON	Battery voltage
50	W	Front fog lamp (LH)	Output	ON or START	Lighting switch must be in the 2nd position (LOW beam is ON) and the front fog lamp switch OFF	0V
					ON	Battery voltage
51	V	Front fog lamp (RH)	Output	ON or START	Lighting switch must be in the 2nd position (LOW beam is ON) and the front fog lamp switch OFF	0V
					ON	Battery voltage
52	P	LH low beam head-lamp	Output	—	Lighting switch in 2nd position	Battery voltage
54	R	RH low beam head-lamp	Output	—	Lighting switch in 2nd position	Battery voltage
55	G	LH high beam head-lamp	Output	—	Lighting switch in 2nd position and placed in HIGH or PASS position	Battery voltage
56	L	RH high beam head-lamp	Output	—	Lighting switch in 2nd position and placed in HIGH or PASS position	Battery voltage
57	GR	Parking, license, and tail lamp	Output	ON	Lighting switch 1st position OFF	0V
					ON	Battery voltage
59	B	Ground	Input	—	—	0V
60	GR	Rear window defogger relay	Output	ON or START	Rear defogger switch ON	Battery voltage
					Rear defogger switch OFF	0V
61	R/B	Fuse 32	Output	OFF	—	Battery voltage

*: When horn reminder is ON

IPDM E/R (INTELLIGENT POWER DISTRIBUTION MODULE ENGINE ROOM)

< ECU DIAGNOSIS >

Wiring Diagram

INFOID:000000004459306

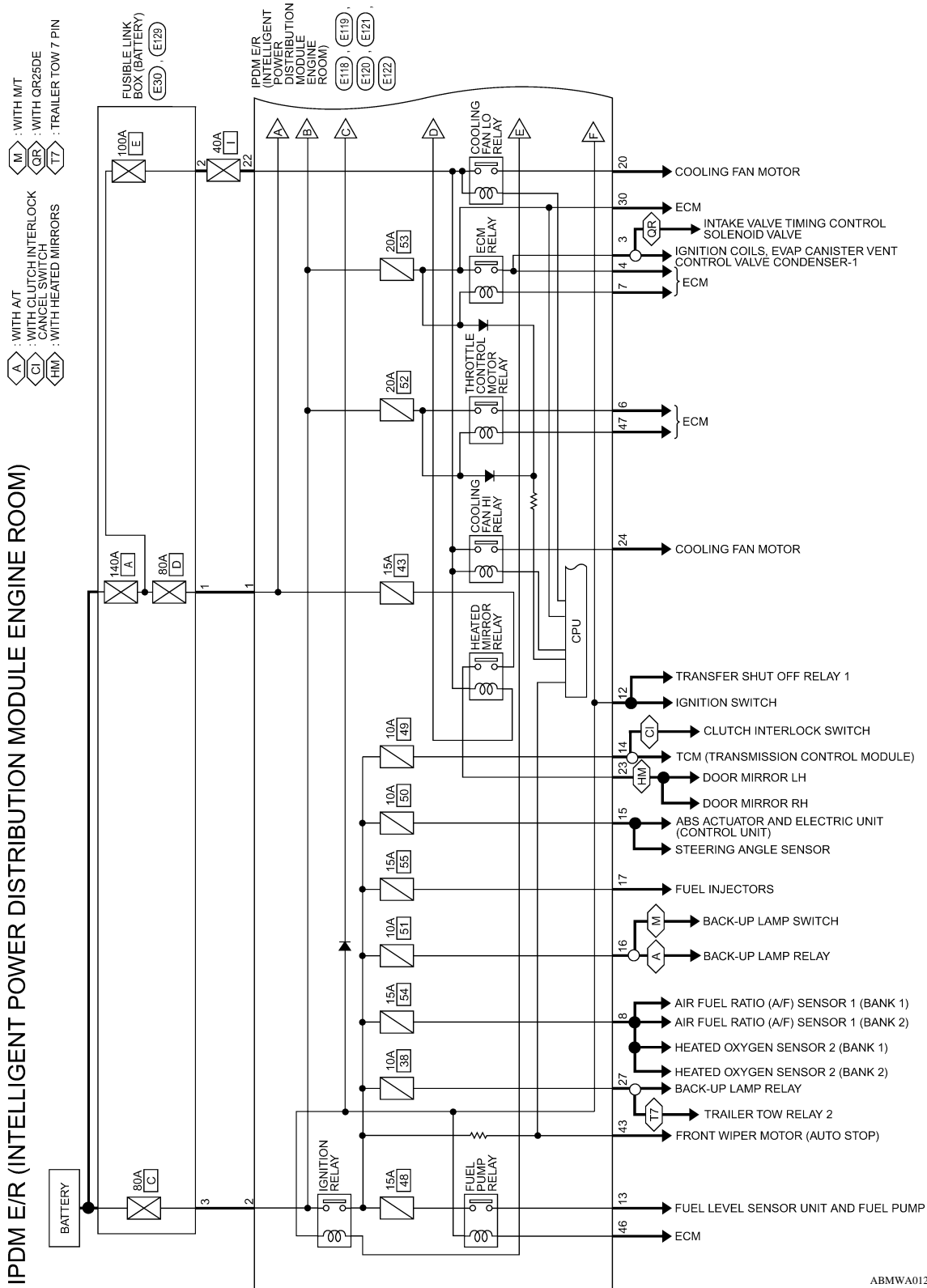

ABMWA0126GI

IPDM E/R (INTELLIGENT POWER DISTRIBUTION MODULE ENGINE ROOM)

< ECU DIAGNOSIS >

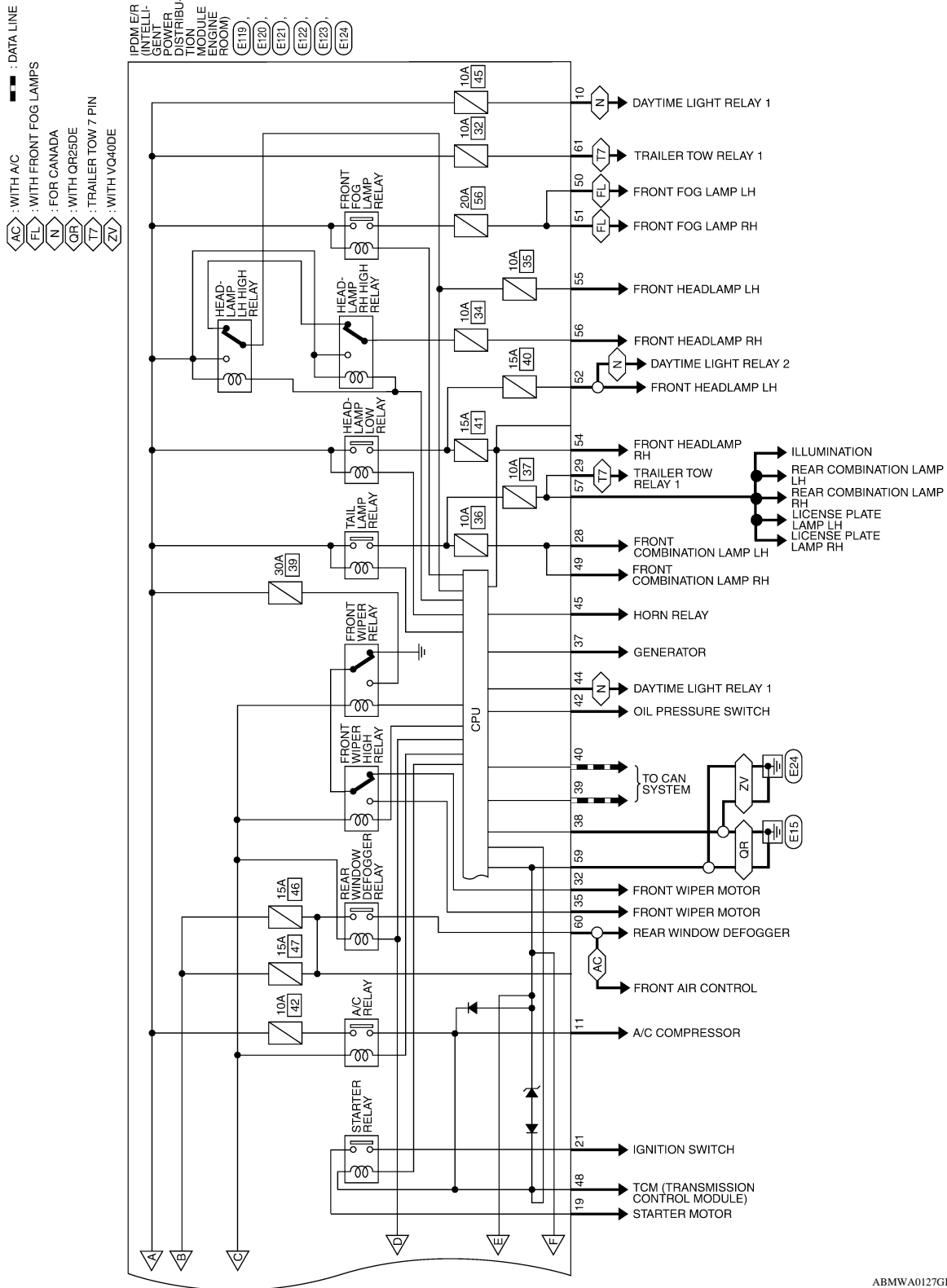

ABMWA0127GI



IPDM E/R (INTELLIGENT POWER DISTRIBUTION MODULE ENGINE ROOM)

< ECU DIAGNOSIS >

IPDM E/R (INTELLIGENT POWER DISTRIBUTION MODULE ENGINE ROOM) CONNECTORS

Connector No.	E30
Connector Name	FUSIBLE LINK BOX (BATTERY)
Connector Color	-



Terminal No.	Color of Wire	Signal Name
3	R	-

Connector No.	E118
Connector Name	IPDM E/R (INTELLIGENT POWER DISTRIBUTION MODULE ENGINE ROOM)
Connector Color	BLACK



Terminal No.	Color of Wire	Signal Name
1	W	F/L USM
2	R	F/L MAIN

Connector No.	E119
Connector Name	IPDM E/R (INTELLIGENT POWER DISTRIBUTION MODULE ENGINE ROOM)
Connector Color	WHITE



Terminal No.	Color of Wire	Signal Name
3	G	IGN COIL
4	P	ECM
5	-	-
6	V	ETC

Terminal No.	Color of Wire	Signal Name
7	BR	ECM RLY CONT
8	W/R	O2 SENSOR
9	-	-
10	R/B	DTRL RLY SUPPLY
11	Y	A/C COMPRESSOR
12	W/G	IGN SW (IG1)
13	R	FUEL PUMP
14	W/G	A/T ECU IGN SUPPLY
15	W/R	ABS IGN SUPPLY
16	W/G	REVERSE LAMP
17	W/G	INJECTOR
18	-	-

Connector No.	E120
Connector Name	IPDM E/R (INTELLIGENT POWER DISTRIBUTION MODULE ENGINE ROOM)
Connector Color	WHITE

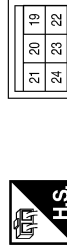

Terminal No.	Color of Wire	Signal Name
19	W	STARTER MTR
20	BR	MOTOR FAN 1
21	GR	IGN SW (ST)
22	G	F/L M/FAN
23	LG	HEATED MIRROR
24	P	MOTOR FAN 2

ABMIA0339GB

IPDM E/R (INTELLIGENT POWER DISTRIBUTION MODULE ENGINE ROOM)

< ECU DIAGNOSIS >

Connector No.	E123
Connector Name	IPDM E/R (INTELLIGENT POWER DISTRIBUTION MODULE ENGINE ROOM)
Connector Color	BROWN

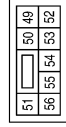

Terminal No.	Color of Wire	Signal Name
49	GR	ILLUMINATION
50	W	FR FOG LAMP LH
51	V	FR FOG LAMP RH
52	P	H/LAMP LO LH
53	-	-
54	R	H/LAMP LO RH
55	G	H/LAMP HI LH
56	L	H/LAMP HI RH

Connector No.	E122
Connector Name	IPDM E/R (INTELLIGENT POWER DISTRIBUTION MODULE ENGINE ROOM)
Connector Color	WHITE

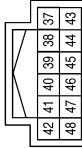

Terminal No.	Color of Wire	Signal Name
37	Y	ALT-C CONT
38	B	GND (SIGNAL)
39	L	CAN-H
40	P	CAN-L
41	-	-
42	GR	OIL PRESSURE SW
43	G	AUTO STOP SW
44	R	DTRL RLY CONT
45	LG	ANT THEFT HORN
46	V	FUEL PUMP RLY CONT
47	O	ETC RLY CONT
48	R	INHIBIT SW

Connector No.	E121
Connector Name	IPDM E/R (INTELLIGENT POWER DISTRIBUTION MODULE ENGINE ROOM)
Connector Color	BROWN

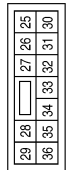

Terminal No.	Color of Wire	Signal Name
25	-	-
26	-	-
27	W	T TOW REV LAMP
28	R	ILLUMINATION
29	G	TRAILER RLY CONT
30	R/B	ECM BATT
31	-	-
32	GR	FR WIPER LO
33	-	-
34	-	-
35	L	FR WIPER HI
36	-	-

A
B
C
D
E
F
G
H
I
J
K
L
M
N
O
P



MWI

ABMLA0340GB

IPDM E/R (INTELLIGENT POWER DISTRIBUTION MODULE ENGINE ROOM)



< ECU DIAGNOSIS >

Connector No.	E129
Connector Name	FUSIBLE LINK BOX (BATTERY)
Connector Color	BROWN

Terminal No.	Color of Wire	Signal Name
1	W	-
2	R	-

Connector No.	E124
Connector Name	IPDM E/R (INTELLIGENT POWER DISTRIBUTION MODULE ENGINE ROOM)
Connector Color	BLACK

Terminal No.	Color of Wire	Signal Name
57	GR	TAIL LAMP
58	-	-
59	B	GND (POWER)
60	GR	RR DEF
61	R/B	TRAIL_RLY SUPPLY
62	-	-

ABMIA0341GB

Fail Safe

INFOID:000000004459307

CAN COMMUNICATION CONTROL

When CAN communication with ECM and BCM is impossible, IPDM E/R performs fail-safe control. After CAN communication recovers normally, it also returns to normal control.

If No CAN Communication Is Available With ECM

IPDM E/R (INTELLIGENT POWER DISTRIBUTION MODULE ENGINE ROOM)

< ECU DIAGNOSIS >

Control part	Fail-safe in operation
Cooling fan	<ul style="list-style-type: none"> • Turns ON the cooling fan relay when the ignition switch is turned ON • Turns OFF the cooling fan relay when the ignition switch is turned OFF

If No CAN Communication Is Available With BCM

Control part	Fail-safe in operation
Headlamp	<ul style="list-style-type: none"> • Turns ON the headlamp low relay when the ignition switch is turned ON • Turns OFF the headlamp low relay when the ignition switch is turned OFF • Headlamp (LH/RH) high relays OFF
<ul style="list-style-type: none"> • Parking lamps • License plate lamps • Tail lamps 	<ul style="list-style-type: none"> • Turns ON the tail lamp relay when the ignition switch is turned ON • Turns OFF the tail lamp relay when the ignition switch is turned OFF
Front wiper	<ul style="list-style-type: none"> • The status just before activation of fail-safe control is maintained until the ignition switch is turned OFF while the front wiper is operating at LO or HI speed. • The wiper is operated at LO speed until the ignition switch is turned OFF if the fail-safe control is activated while the front wiper is set in the INT mode and the front wiper motor is operating.
Rear window defogger	Rear window defogger relay OFF
A/C compressor (if equipped)	A/C relay OFF
Front fog lamps (if equipped)	Front fog lamp relay OFF

IGNITION RELAY MALFUNCTION DETECTION FUNCTION

- IPDM E/R monitors the voltage at the contact circuit and excitation coil circuit of the ignition relay inside it.
- IPDM E/R judges the ignition relay error if the voltage differs between the contact circuit and the excitation coil circuit.
- If the ignition relay cannot turn OFF due to contact seizure, it activates the tail lamp relay for 10 minutes to alert the user to the ignition relay malfunction when the ignition switch is turned OFF.

Ignition switch	Ignition relay	Tail lamp relay
ON	ON	—
OFF	OFF	—

NOTE:

The tail lamp turns OFF when the ignition switch is turned ON.

FRONT WIPER CONTROL

IPDM E/R detects front wiper stop position by a front wiper auto stop signal.

When a front wiper auto stop signal is in the conditions listed below, IPDM E/R stops power supply to wiper after repeating a front wiper 10 second activation and 20 second stop five times.

Ignition switch	Front wiper switch	Auto stop signal
ON	OFF	Front wiper stop position signal cannot be input 10 seconds.
	ON	The signal does not change for 10 seconds.

NOTE:

This operation status can be confirmed on the IPDM E/R “DATA MONITOR” that displays “Block” for the item “WIP PROT” while the wiper is stopped.

STARTER MOTOR PROTECTION FUNCTION

IPDM E/R turns OFF the starter control relay to protect the starter motor when the starter control relay remains active for 90 seconds.

A
B
C
D
E
F
G
H
I
J
K
L
M
N
O
P

IPDM E/R (INTELLIGENT POWER DISTRIBUTION MODULE ENGINE ROOM)

< ECU DIAGNOSIS >

DTC Index

INFOID:000000004459308

CONSULT-III display	Fail-safe	TIME ^{NOTE}		Refer to
No DTC is detected. further testing may be required.	—	—	—	—
U1000: CAN COMM CIRCUIT	×	CRNT	1 – 39	PCS-18

NOTE:

The details of TIME display are as follows.

- CRNT: The malfunctions that are detected now
- 1 - 39: The number is indicated when it is normal at present and a malfunction was detected in the past. It increases like 0 → 1 → 2 ... 38 → 39 after returning to the normal condition whenever IGN OFF → ON. It is fixed to 39 until the self-diagnosis results are erased if it is over 39. It returns to 0 when a malfunction is detected again in the process.

THE FUEL GAUGE POINTER DOES NOT MOVE

< SYMPTOM DIAGNOSIS >

SYMPTOM DIAGNOSIS

THE FUEL GAUGE POINTER DOES NOT MOVE

Description

INFOID:000000004056955

Fuel gauge needle will not move from a certain position.

Diagnosis Procedure

INFOID:000000004056956

1. CHECK COMBINATION METER INPUT SIGNAL

1. Select "METER/M&A" on CONSULT-III.
2. Using "FUEL METER" of "DATA MONITOR", compare the monitor value with the fuel gauge reading on the combination meter. Refer to [MWI-32, "Component Function Check"](#).

Does monitor value match fuel gauge reading?

YES >> GO TO 2

NO >> Replace combination meter. Refer to [MWI-93, "Removal and Installation"](#).

2. CHECK FUEL LEVEL SENSOR SIGNAL CIRCUIT

Check the fuel level sensor signal circuit. Refer to [MWI-32, "Diagnosis Procedure"](#).

Is the inspection result normal?

YES >> GO TO 3

NO >> Repair harness or connector.

3. CHECK FUEL LEVEL SENSOR UNIT

Perform a unit check for the fuel level sensor unit. Refer to [MWI-33, "Component Inspection"](#).

Is the inspection result normal?

YES >> GO TO 4

NO >> Replace fuel level sensor unit. Refer to [FL-10, "Removal and Installation"](#).

4. CHECK FLOAT INTERFERENCE

Check that the float arm does not interfere or bind with any of the components in the fuel tank.

Is the inspection result normal?

YES >> Replace combination meter. Refer to [MWI-93, "Removal and Installation"](#).

NO >> Repair or replace malfunctioning parts.

A
B
C
D
E
F
G
H
I
J
K
L
M
O
P

MWI

THE FUEL GAUGE POINTER DOES NOT MOVE TO "F" WHEN REFUELING

< SYMPTOM DIAGNOSIS >

THE FUEL GAUGE POINTER DOES NOT MOVE TO "F" WHEN REFUELING

Description

INFOID:000000004056957

The fuel gauge needle will not move to "F" position when refueling.

Diagnosis Procedure

INFOID:000000004056958

1.OBSERVE FUEL GAUGE

Does it take a long time for the pointer to move to FULL position?

YES or NO

YES >> GO TO 2

NO >> GO TO 3

2.IDENTIFY FUELING CONDITION

Was the vehicle fueled with the ignition switch ON?

YES or NO

YES >> Be sure to fuel the vehicle with the ignition switch OFF. Otherwise, it will take a long time to move to FULL position because of the characteristic of the fuel gauge.

NO >> GO TO 3

3.OBSERVE VEHICLE POSITION

Is the vehicle parked on an incline?

YES or NO

YES >> Check the fuel level indication with vehicle on a level surface.

NO >> GO TO 4

4.OBSERVE FUEL GAUGE POINTER

During driving, does the fuel gauge pointer move gradually toward EMPTY position?

YES or NO

YES >> Check the components. Refer to [MWI-33. "Component Inspection"](#).

NO >> The float arm may interfere or bind with any of the components in the fuel tank.

THE OIL PRESSURE WARNING LAMP DOES NOT TURN ON

< SYMPTOM DIAGNOSIS >

THE OIL PRESSURE WARNING LAMP DOES NOT TURN ON

Description

INFOID:000000004056959

The oil pressure warning lamp stays off when the ignition switch is turned ON.

Diagnosis Procedure

INFOID:000000004056960

1.CHECK OIL PRESSURE WARNING LAMP

Perform IPDM E/R auto active test. Refer to [PCS-13, "Diagnosis Description"](#).

Is oil pressure warning lamp illuminated?

YES >> GO TO 2

NO >> Replace combination meter. Refer to [MWI-93, "Removal and Installation"](#).

2.CHECK OIL PRESSURE SWITCH SIGNAL CIRCUIT

Check the oil pressure switch signal circuit. Refer to [MWI-34, "Diagnosis Procedure"](#).

Is the inspection result normal?

YES >> GO TO 3

NO >> Repair harness or connector.

3.CHECK OIL PRESSURE SWITCH UNIT

Perform a unit check for the oil pressure switch. Refer to [MWI-34, "Component Inspection"](#).

Is the inspection result normal?

YES >> Replace IPDM E/R. Refer to [PCS-34, "Removal and Installation of IPDM E/R"](#).

NO >> Replace oil pressure switch.

A
B
C
D
E
F
G
H
I
J
K
L
M
O
P

MWI

THE OIL PRESSURE WARNING LAMP DOES NOT TURN OFF

< SYMPTOM DIAGNOSIS >

THE OIL PRESSURE WARNING LAMP DOES NOT TURN OFF

Description

INFOID:000000004056961

The oil pressure warning lamp remains illuminated while the engine is running (normal oil pressure).

Diagnosis Procedure

INFOID:000000004056962

1. CHECK OIL PRESSURE WARNING LAMP

Perform IPDM E/R auto active test. Refer to [PCS-13, "Diagnosis Description"](#).

Is oil pressure warning lamp illuminated?

YES >> GO TO 2

NO >> Replace combination meter. Refer to [MWI-93, "Removal and Installation"](#).

2. CHECK IPDM E/R OUTPUT VOLTAGE

1. Turn ignition switch OFF.
2. Disconnect the oil pressure switch connector.
3. Turn ignition switch ON.
4. Check voltage between the oil pressure switch harness connector E208 (VQ40DE) or F4 (QR25DE) terminal 1 and ground.

1 – Ground : Approx. 12V

Is the inspection result normal?

YES >> GO TO 3

NO >> GO TO 4

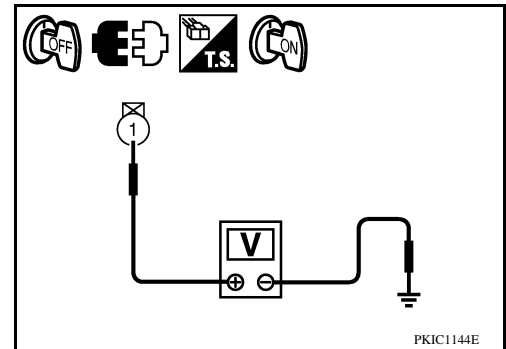

3. CHECK OIL PRESSURE SWITCH

Perform a unit check for the oil pressure switch. Refer to [MWI-34, "Component Inspection"](#).

Is the inspection result normal?

YES >> Replace IPDM E/R. Refer to [PCS-34, "Removal and Installation of IPDM E/R"](#).

NO >> Replace oil pressure switch.

4. CHECK OIL PRESSURE SWITCH SIGNAL CIRCUIT

Check the oil pressure switch signal circuit. Refer to [MWI-34, "Diagnosis Procedure"](#).

Is the inspection result normal?

YES >> Replace IPDM E/R. Refer to [PCS-34, "Removal and Installation of IPDM E/R"](#).

NO >> Repair harness or connector.

NORMAL OPERATING CONDITION

< SYMPTOM DIAGNOSIS >

NORMAL OPERATING CONDITION COMPASS

COMPASS : Description

INFOID:000000004056963

COMPASS

- The electronic compass is highly protected from changes in most magnetic fields. However, some large changes in magnetic fields can affect it. Some examples are (but not limited to): high tension power lines, large steel buildings, subways, steel bridges, automatic car washes, large piles of scrap metal, etc. While this does not happen very often, it is possible.
- During normal operation, the Compass Mirror will continuously update the compass calibration to adjust for gradual changes in the vehicle's magnetic "remnant" field. If the vehicle is subjected to high magnetic influences, the compass may appear to indicate false headings, become locked, or appear that it is unable to be calibrated. If this occurs, perform the calibration procedure.
- If at any time the compass continually displays the incorrect direction or the reading is erratic or locked, verify the correct zone variance.

Symptom Chart

Symptom	Cause	Solution / Reference
The compass display reads "C".	<ul style="list-style-type: none"> • Compass is not calibrated. • Incorrect zone variance setting. • Large change in magnetic field (Steel bridges, subways, concentrations of metal, car washes, etc.) • Compass was calibrated incorrectly or in the presence of a strong magnetic field. 	Perform Calibration. Refer to MWI-21, "Description" .
Compass shows the wrong direction.		
Compass does not change direction appears "Locked".		
Compass does not show all the directions, one or more is missing.		
The compass was calibrated but it "loses" calibration.		
On long trips the compass shows the wrong direction.	Perform Zone Variation Setting if correct reading is desired in that location. Refer to MWI-21, "Description" .	

A
B
C
D
E
F
G
H
I
J
K
L
M
O
P

MWI

PRECAUTIONS

< PRECAUTION >

PRECAUTION

PRECAUTIONS

Supplemental Restraint System (SRS) "AIR BAG" and "SEAT BELT PRE-TENSIONER"

INFOID:000000004056964

The Supplemental Restraint System such as "AIR BAG" and "SEAT BELT PRE-TENSIONER", used along with a front seat belt, helps to reduce the risk or severity of injury to the driver and front passenger for certain types of collision. This system includes seat belt switch inputs and dual stage front air bag modules. The SRS system uses the seat belt switches to determine the front air bag deployment, and may only deploy one front air bag, depending on the severity of a collision and whether the front occupants are belted or unbelted. Information necessary to service the system safely is included in the SR and SB section of this Service Manual.

WARNING:

- To avoid rendering the SRS inoperative, which could increase the risk of personal injury or death in the event of a collision which would result in air bag inflation, all maintenance must be performed by an authorized NISSAN/INFINITI dealer.
- Improper maintenance, including incorrect removal and installation of the SRS, can lead to personal injury caused by unintentional activation of the system. For removal of Spiral Cable and Air Bag Module, see the SR section.
- Do not use electrical test equipment on any circuit related to the SRS unless instructed to in this Service Manual. SRS wiring harnesses can be identified by yellow and/or orange harnesses or harness connectors.

COMBINATION METER

< ON-VEHICLE REPAIR >

ON-VEHICLE REPAIR

COMBINATION METER

Removal and Installation

INFOID:000000004056965

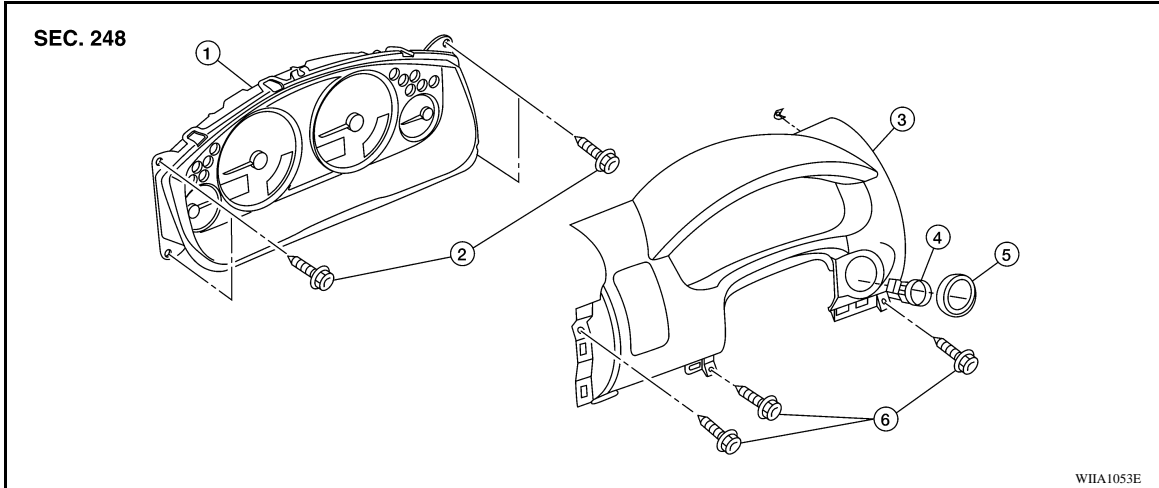

- | | | |
|---|-----------------------------|------------------|
| 1. Combination meter | 2. Screws | 3. Cluster lid A |
| 4. Ignition key lamp assembly (if equipped) | 5. Steering lock escutcheon | 6. Screws |

1. Disconnect the negative battery terminal.
2. Remove the front pillar upper finisher. Refer to [INT-17, "Removal and Installation"](#).
3. Remove the lower instrument panel LH. Refer to [IP-11, "Removal and Installation"](#).
4. Remove the steering lock escutcheon.
5. Remove the cluster lid A, using a power tool.
6. Remove the combination meter, using a power tool.
7. Disconnect the combination meter electrical connectors.

INSTALLATION

Installation is in the reverse order of removal.

A
B
C
D
E
F
G
H
I
J
K
L
M
N
O
P

MWI