

# SECTION **ADP**

## AUTOMATIC DRIVE POSITIONER

A  
B  
C  
D  
E  
F  
G  
H  
I  
J  
K  
L  
M  
N  
O  
P

### CONTENTS

<p><b>BASIC INSPECTION</b> ..... 5</p> <p><b>DIAGNOSIS AND REPAIR WORKFLOW</b> ..... 5</p> <p style="padding-left: 20px;">Work Flow .....5</p> <p><b>INSPECTION AND ADJUSTMENT</b> ..... 8</p> <p style="padding-left: 20px;">Preliminary Check .....8</p> <p style="padding-left: 20px;">Special Repair Requirement .....8</p> <p><b>FUNCTION DIAGNOSIS</b> ..... 9</p> <p><b>AUTOMATIC DRIVE POSITIONER SYSTEM..... 9</b></p> <p><b>AUTOMATIC DRIVE POSITIONER SYSTEM</b> .....9</p> <p style="padding-left: 20px;">AUTOMATIC DRIVE POSITIONER SYSTEM : System Diagram .....9</p> <p style="padding-left: 20px;">AUTOMATIC DRIVE POSITIONER SYSTEM : System Description ..... 10</p> <p style="padding-left: 20px;">AUTOMATIC DRIVE POSITIONER SYSTEM : Component Parts Location ..... 11</p> <p style="padding-left: 20px;">AUTOMATIC DRIVE POSITIONER SYSTEM : Component Description ..... 12</p> <p><b>MANUAL FUNCTION</b> ..... 13</p> <p style="padding-left: 20px;">MANUAL FUNCTION : System Diagram ..... 14</p> <p style="padding-left: 20px;">MANUAL FUNCTION : System Description ..... 14</p> <p style="padding-left: 20px;">MANUAL FUNCTION : Component Parts Location ..... 16</p> <p style="padding-left: 20px;">MANUAL FUNCTION : Component Description .... 17</p> <p><b>MEMORY FUNCTION</b> ..... 18</p> <p style="padding-left: 20px;">MEMORY FUNCTION : System Diagram ..... 18</p> <p style="padding-left: 20px;">MEMORY FUNCTION : System Description ..... 18</p> <p style="padding-left: 20px;">MEMORY FUNCTION : Component Parts Location ..... 20</p> <p style="padding-left: 20px;">MEMORY FUNCTION : Component Description...21</p> <p><b>EXIT ASSIST FUNCTION</b> ..... 21</p> <p style="padding-left: 20px;">EXIT ASSIST FUNCTION : System Diagram ..... 22</p> <p style="padding-left: 20px;">EXIT ASSIST FUNCTION : System Description .... 22</p> <p style="padding-left: 20px;">EXIT ASSIST FUNCTION : Component Parts Location ..... 24</p>	<p style="padding-left: 20px;">EXIT ASSIST FUNCTION : Component Description .....25</p> <p><b>ENTRY ASSIST FUNCTION</b> .....25</p> <p style="padding-left: 20px;">ENTRY ASSIST FUNCTION : System Diagram ....26</p> <p style="padding-left: 20px;">ENTRY ASSIST FUNCTION : System Description .....26</p> <p style="padding-left: 20px;">ENTRY ASSIST FUNCTION : Component Parts Location .....28</p> <p style="padding-left: 20px;">ENTRY ASSIST FUNCTION : Component Description .....29</p> <p><b>INTELLIGENT KEY INTERLOCK FUNCTION</b> .....29</p> <p style="padding-left: 20px;">INTELLIGENT KEY INTERLOCK FUNCTION : System Diagram .....30</p> <p style="padding-left: 20px;">INTELLIGENT KEY INTERLOCK FUNCTION : System Description .....30</p> <p style="padding-left: 20px;">INTELLIGENT KEY INTERLOCK FUNCTION : Component Parts Location .....32</p> <p style="padding-left: 20px;">INTELLIGENT KEY INTERLOCK FUNCTION : Component Description .....33</p> <p><b>DIAGNOSIS SYSTEM (DRIVER SEAT C/U) ....34</b></p> <p style="padding-left: 20px;">Diagnosis Description .....34</p> <p style="padding-left: 20px;">CONSULT-III Function (AUTO DRIVE POS.) .....34</p> <p><b>COMPONENT DIAGNOSIS</b> .....37</p> <p><b>U1000 CAN COMM CIRCUIT</b> .....37</p> <p style="padding-left: 20px;">Description .....37</p> <p style="padding-left: 20px;">DTC Logic .....37</p> <p style="padding-left: 20px;">Diagnosis Procedure .....37</p> <p style="padding-left: 20px;">Special Repair Requirement .....37</p> <p><b>U1010 CONTROL UNIT (CAN)</b> .....38</p> <p style="padding-left: 20px;">Description .....38</p> <p style="padding-left: 20px;">DTC Logic .....38</p> <p style="padding-left: 20px;">Diagnosis Procedure .....38</p> <p><b>B2130 EEPROM</b> .....39</p> <p style="padding-left: 20px;">DTC Logic .....39</p> <p style="padding-left: 20px;">Diagnosis Procedure .....39</p>
---	---

ADP

<b>B2112 SLIDING MOTOR</b> .....	<b>40</b>	<b>TILT SWITCH</b> .....	<b>56</b>
Description .....	40	Description .....	56
DTC Logic .....	40	Component Function Check .....	56
Diagnosis Procedure .....	40	Diagnosis Procedure .....	56
		Component Inspection .....	57
<b>B2113 RECLINING MOTOR</b> .....	<b>41</b>	<b>TELESCOPIC SWITCH</b> .....	<b>58</b>
Description .....	41	Description .....	58
DTC Logic .....	41	Component Function Check .....	58
Diagnosis Procedure .....	41	Diagnosis Procedure .....	58
		Component Inspection .....	59
<b>B2116 TILT MOTOR</b> .....	<b>42</b>	<b>SEAT MEMORY SWITCH</b> .....	<b>60</b>
Description .....	42	Description .....	60
DTC Logic .....	42	Component Function Check .....	60
Diagnosis Procedure .....	42	Diagnosis Procedure .....	60
		Component Inspection .....	61
<b>B2128 UART COMMUNICATION LINE</b> .....	<b>43</b>	<b>DOOR MIRROR REMOTE CONTROL SWITCH</b> .....	<b>62</b>
Description .....	43		
DTC Logic .....	43	<b>CHANGEOVER SWITCH</b> .....	<b>62</b>
Diagnosis Procedure .....	43	CHANGEOVER SWITCH : Description .....	62
		CHANGEOVER SWITCH : Component Function Check .....	62
<b>POWER SUPPLY AND GROUND CIRCUIT</b> ....	<b>45</b>	CHANGEOVER SWITCH : Diagnosis Procedure ...	62
		CHANGEOVER SWITCH : Component Inspection .....	64
<b>BCM</b> .....	<b>45</b>	<b>MIRROR SWITCH</b> .....	<b>64</b>
BCM : Diagnosis Procedure .....	45	MIRROR SWITCH : Description .....	64
<b>DRIVER SEAT CONTROL UNIT</b> .....	<b>45</b>	MIRROR SWITCH : Component Function Check... 64	
DRIVER SEAT CONTROL UNIT :		MIRROR SWITCH : Diagnosis Procedure .....	64
Diagnosis Procedure .....	46	MIRROR SWITCH : Component Inspection .....	66
DRIVER SEAT CONTROL UNIT : Special Repair Requirement .....	46	<b>POWER SEAT SWITCH GROUND CIRCUIT</b> ...	<b>68</b>
		Diagnosis Procedure .....	68
<b>AUTOMATIC DRIVE POSITIONER CONTROL UNIT</b> .....	<b>46</b>	<b>TILT &amp; TELESCOPIC SWITCH GROUND CIRCUIT</b> .....	<b>69</b>
AUTOMATIC DRIVE POSITIONER CONTROL UNIT : Diagnosis Procedure .....	46	Diagnosis Procedure .....	69
AUTOMATIC DRIVE POSITIONER CONTROL UNIT : Special Repair Requirement .....	47	<b>FRONT DOOR SWITCH (DRIVER SIDE)</b> .....	<b>70</b>
		Description .....	70
<b>SLIDING SWITCH</b> .....	<b>48</b>	Component Function Check .....	70
Description .....	48	Diagnosis Procedure .....	70
Component Function Check .....	48	Component Inspection .....	70
Diagnosis Procedure .....	48	<b>SLIDING SENSOR</b> .....	<b>72</b>
Component Inspection .....	49	Description .....	72
<b>RECLINING SWITCH</b> .....	<b>50</b>	Component Function Check .....	72
Description .....	50	Diagnosis Procedure .....	72
Component Function Check .....	50	<b>RECLINING SENSOR</b> .....	<b>75</b>
Diagnosis Procedure .....	50	Description .....	75
Component Inspection .....	51	Component Function Check .....	75
<b>LIFTING SWITCH (FRONT)</b> .....	<b>52</b>	Diagnosis Procedure .....	75
Description .....	52	<b>LIFTING SENSOR (FRONT)</b> .....	<b>78</b>
Component Function Check .....	52	Description .....	78
Diagnosis Procedure .....	52	Component Function Check .....	78
Component Inspection .....	53		
<b>LIFTING SWITCH (REAR)</b> .....	<b>54</b>		
Description .....	54		
Component Function Check .....	54		
Diagnosis Procedure .....	54		
Component Inspection .....	55		

Diagnosis Procedure .....	78	Component Function Check .....	107	
<b>LIFTING SENSOR (REAR) .....</b>	<b>81</b>	Diagnosis Procedure .....	107	A
Description .....	81	Component Inspection .....	109	
Component Function Check .....	81	<b>SEAT MEMORY INDICATOR LAMP .....</b>	<b>110</b>	B
Diagnosis Procedure .....	81	Description .....	110	
<b>TILT SENSOR .....</b>	<b>84</b>	Component Function Check .....	110	
Description .....	84	Diagnosis Procedure .....	110	C
Component Function Check .....	84	Component Inspection .....	111	
Diagnosis Procedure .....	84	<b>ECU DIAGNOSIS .....</b>	<b>112</b>	
<b>TELESCOPIC SENSOR .....</b>	<b>87</b>	<b>DRIVER SEAT CONTROL UNIT .....</b>	<b>112</b>	D
Description .....	87	Reference Value .....	112	
Component Function Check .....	87	Wiring Diagram .....	118	
Diagnosis Procedure .....	87	Fail Safe .....	131	E
<b>MIRROR SENSOR .....</b>	<b>90</b>	DTC Index .....	132	
<b>DRIVER SIDE .....</b>	<b>90</b>	<b>AUTOMATIC DRIVE POSITIONER CON-</b>	<b>133</b>	F
DRIVER SIDE : Description .....	90	<b>TROL UNIT .....</b>	<b>133</b>	
DRIVER SIDE : Component Function Check .....	90	Reference Value .....	133	
DRIVER SIDE : Diagnosis Procedure .....	90	Wiring Diagram .....	136	G
<b>PASSENGER SIDE .....</b>	<b>92</b>	<b>BCM (BODY CONTROL MODULE) .....</b>	<b>150</b>	
PASSENGER SIDE : Description .....	92	Reference Value .....	150	
PASSENGER SIDE :		Terminal Layout .....	155	H
Component Function Check .....	92	Physical Values .....	155	
PASSENGER SIDE : Diagnosis Procedure .....	92	Wiring Diagram .....	174	
<b>SLIDING MOTOR .....</b>	<b>95</b>	Fail Safe .....	182	I
Description .....	95	DTC Inspection Priority Chart .....	184	
Component Function Check .....	95	DTC Index .....	185	
Diagnosis Procedure .....	95	<b>SYMPTOM DIAGNOSIS .....</b>	<b>188</b>	ADP
<b>RECLINING MOTOR .....</b>	<b>97</b>	<b>ADP SYSTEM SYMPTOMS .....</b>	<b>188</b>	
Description .....	97	Symptom Table .....	188	K
Component Function Check .....	97	<b>NORMAL OPERATING CONDITION .....</b>	<b>190</b>	
Diagnosis Procedure .....	97	Description .....	190	L
<b>LIFTING MOTOR (FRONT) .....</b>	<b>99</b>	<b>PRECAUTION .....</b>	<b>191</b>	
Description .....	99	<b>PRECAUTIONS .....</b>	<b>191</b>	M
Component Function Check .....	99	Precaution for Supplemental Restraint System		
Diagnosis Procedure .....	99	(SRS) "AIR BAG" and "SEAT BELT PRE-TEN-		
<b>LIFTING MOTOR (REAR) .....</b>	<b>101</b>	SIONER" .....	191	N
Description .....	101	Precautions Necessary for Steering Wheel Rota-		
Component Function Check .....	101	tion after Battery Disconnect .....	191	
Diagnosis Procedure .....	101	Precaution for Work .....	191	
<b>TILT MOTOR .....</b>	<b>103</b>	<b>ON-VEHICLE REPAIR .....</b>	<b>193</b>	O
Description .....	103	<b>DRIVER SEAT CONTROL UNIT .....</b>	<b>193</b>	
Component Function Check .....	103	Removal and Installation .....	193	P
Diagnosis Procedure .....	103	<b>AUTOMATIC DRIVE POSITIONER CON-</b>	<b>194</b>	
<b>TELESCOPIC MOTOR .....</b>	<b>105</b>	<b>TROL UNIT .....</b>	<b>194</b>	
Description .....	105	Removal and Installation .....	194	
Component Function Check .....	105	<b>SEAT MEMORY SWITCH .....</b>	<b>195</b>	
Diagnosis Procedure .....	105	Removal and Installation .....	195	
<b>DOOR MIRROR MOTOR .....</b>	<b>107</b>			
Description .....	107			

---

<b>TILT&amp;TELESCOPIC SWITCH .....</b>	<b>196</b>	<b>Removal and Installation .....</b>	<b>196</b>
---	------------	---------------------------------------	------------

# DIAGNOSIS AND REPAIR WORKFLOW

< BASIC INSPECTION >

## BASIC INSPECTION

### DIAGNOSIS AND REPAIR WORKFLOW

Work Flow

INFOID:000000003900237

WORK FLOW

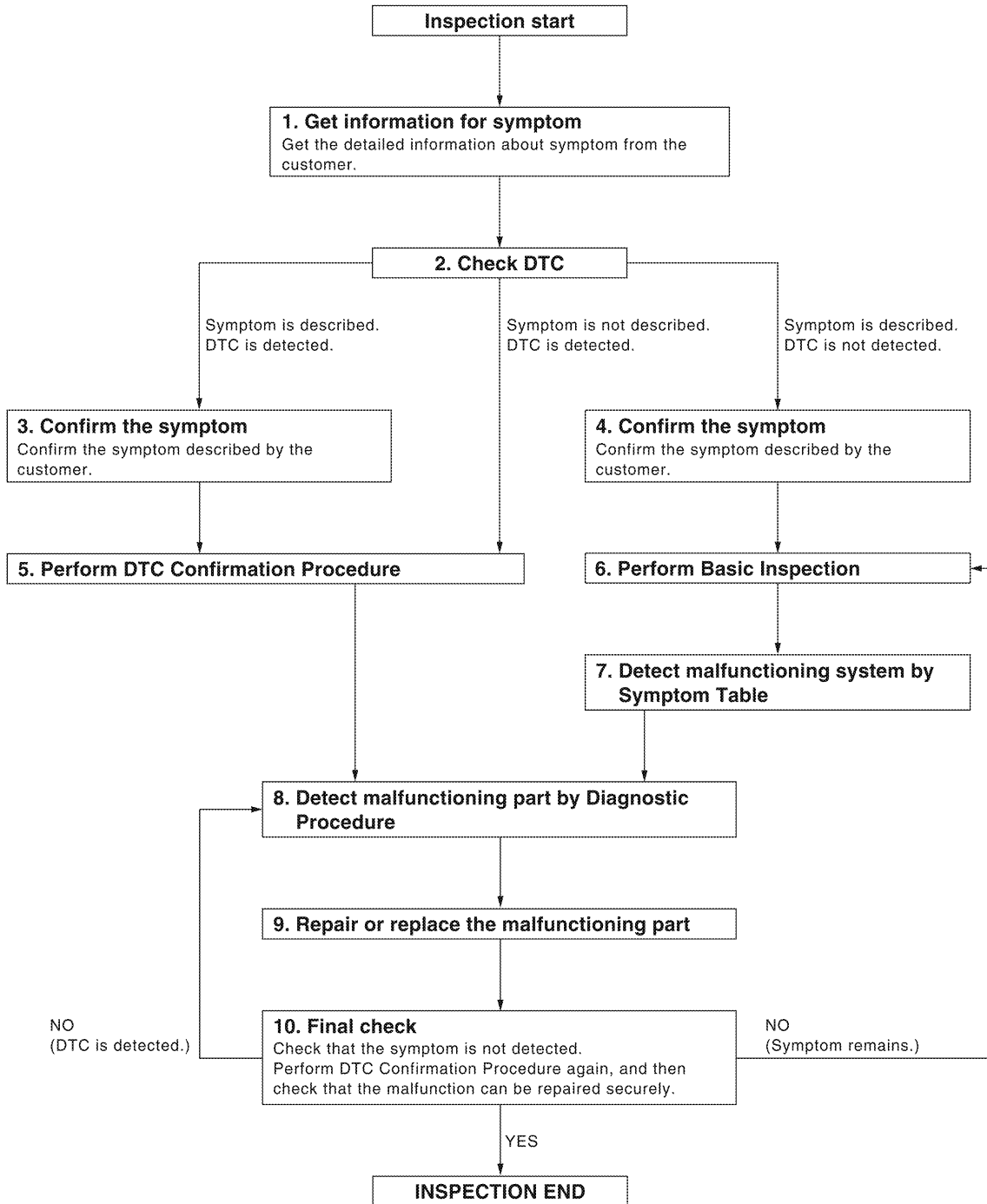

A  
B  
C  
D  
E  
F  
G  
H  
I  
K  
L  
M  
N  
O  
P

ADP

DETAILED FLOW

# DIAGNOSIS AND REPAIR WORKFLOW

< BASIC INSPECTION >

---

## 1. GET INFORMATION FOR SYMPTOM

---

Get the detailed information from the customer about the symptom (the condition and the environment when the incident/malfunction occurred).

>> GO TO 2

## 2. CHECK DTC WITH AUTOMATIC DRIVE POSITIONER SYSTEM

---

Check "Self Diagnostic Result" with CONSULT-III.

Refer to [ADP-132. "DTC Index"](#).

Is any symptom described and any DTC displayed?

Symptom is described, DTC is displayed.>>GO TO 3

Symptom is not described, DTC is displayed.>>GO TO 7

Symptom is described, DTC is not displayed.>>GO TO 4

## 3. CONFIRM THE SYMPTOM

---

Try to confirm the symptom described by the customer.

>> GO TO 7

## 4. CONFIRM THE SYMPTOM

---

Try to confirm the symptom described by the customer.

>> GO TO 5

## 5. CHECK NORMAL OPERATING CONDITION

---

Check normal operating condition. Refer to [ADP-190. "Description"](#).

Is the incident normal operation?

YES >> Inspection End.

NO >> GO TO 6

## 6. PERFORM BASIC INSPECTION

---

Isolate the malfunctioning part with the basic inspection. Refer to [ADP-8. "Preliminary Check"](#).

>> GO TO 8

## 7. PERFORM DTC CONFIRMATION PROCEDURE

---

Perform the confirmation procedure for the detected DTC.

Is the DTC displayed?

YES >> GO TO 9

NO >> Check intermittent incident. Refer to [GI-39. "Intermittent Incident"](#).

## 8. PERFORM COMPONENT FUNCTION CHECK

---

Perform the component function check for the isolated malfunctioning part.

>> GO TO 9

## 9. DETECT MALFUNCTIONING PART BY DIAGNOSTIC PROCEDURE

---

Isolate the malfunctioning part by performing the diagnosis procedure relevant to the symptom during the component diagnosis.

>> GO TO 10

## 10. REPAIR OR REPLACE

---

Repair or replace the malfunctioning part.

# DIAGNOSIS AND REPAIR WORKFLOW

< BASIC INSPECTION >

---

>> GO TO 11

## 11. FINAL CHECK

Perform the DTC confirmation procedure (if DTC is detected) or component function check (if no DTC is detected) again, and then check that the malfunction can be repaired securely.

Are all malfunctions corrected?

YES >> Inspection End.

Symptom is detected.>> GO TO 4

DTC is detected.>> GO TO 7

A

B

C

D

E

F

G

H

I

ADP

K

L

M

N

O

P

# INSPECTION AND ADJUSTMENT

< BASIC INSPECTION >

---

## INSPECTION AND ADJUSTMENT

### Preliminary Check

INFOID:000000003900238

#### 1. FOREIGN OBJECTS

---

Check the following:

- objects on or behind the seats that could cause binding
- objects under the seats that may be interfering with the seat's moving parts
- objects under pedals that may interfere with movement

Are there any foreign objects that could be causing interference?

- YES >> Remove objects.  
NO >> GO TO 2

#### 2. WIRING CONNECTIONS

---

1. Disconnect harness connectors.
2. Check terminals for damage or loose connections.
3. Reconnect harness connectors.

Are any connectors damaged or loose?

- YES >> Repair or replace damaged parts.  
NO >> GO TO 3

#### 3. POWER AND GROUND

---

Check power supply and ground circuits for control unit. Refer to [ADP-46, "DRIVER SEAT CONTROL UNIT : Diagnosis Procedure"](#).

Is the inspection result normal?

- YES >> Refer to [ADP-132, "DTC Index"](#).  
NO >> Repair or replace as necessary.

### Special Repair Requirement

INFOID:000000003900239

Refer to Owner's Manual for Automatic Drive Positioner system operating instructions.



# AUTOMATIC DRIVE POSITIONER SYSTEM

< FUNCTION DIAGNOSIS >

## FUNCTION DIAGNOSIS

AUTOMATIC DRIVE POSITIONER SYSTEM

AUTOMATIC DRIVE POSITIONER SYSTEM

AUTOMATIC DRIVE POSITIONER SYSTEM : System Diagram

INFOID:000000003900240

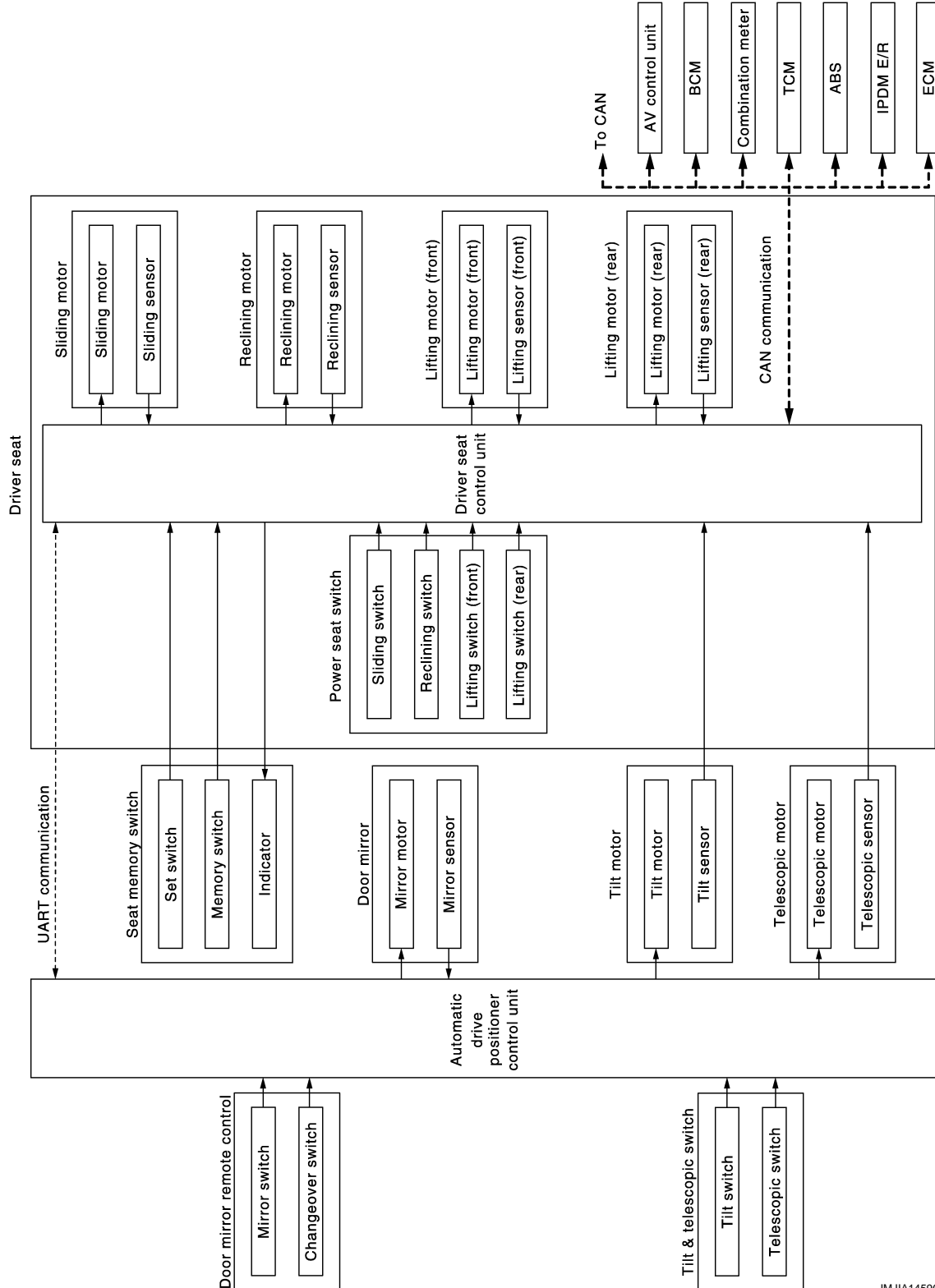

A  
B  
C  
D  
E  
F  
G  
H  
I  
K  
L  
M  
N  
O  
P

ADP

JMJIA1459GB

# AUTOMATIC DRIVE POSITIONER SYSTEM

< FUNCTION DIAGNOSIS >

## AUTOMATIC DRIVE POSITIONER SYSTEM : System Description

INFOID:000000004362973

### OUTLINE

The system automatically moves the driver seat, steering column and door mirror position by the driver seat control unit and the automatic drive positioner control unit. The driver seat control unit corresponds with the automatic drive positioner control unit by UART communication.

Function		Description
Manual function		The driving position (seat, steering column and door mirror position) can be adjusted by using the power seat switch, ADP steering switch or door mirror remote control switch.
Memory function		The seat, steering column and door mirror move to the stored driving position by pressing seat memory switch (1 or 2).
Entry/Exit assist function	Exit	On exit, the seat moves backward and the steering column moves upward.
	Entry	On entry, the seat and steering column returns from exiting position to the previous driving position.
Intelligent Key interlock function		Perform memory operation, exiting operation and entry operation by Intelligent Key unlock operation or driver side door request switch unlock operation.

### NOTE:

The lumbar support system is controlled independently with no link to the automatic drive positioner system.

# AUTOMATIC DRIVE POSITIONER SYSTEM

< FUNCTION DIAGNOSIS >

## AUTOMATIC DRIVE POSITIONER SYSTEM : Component Parts Location INFOID:000000003900241

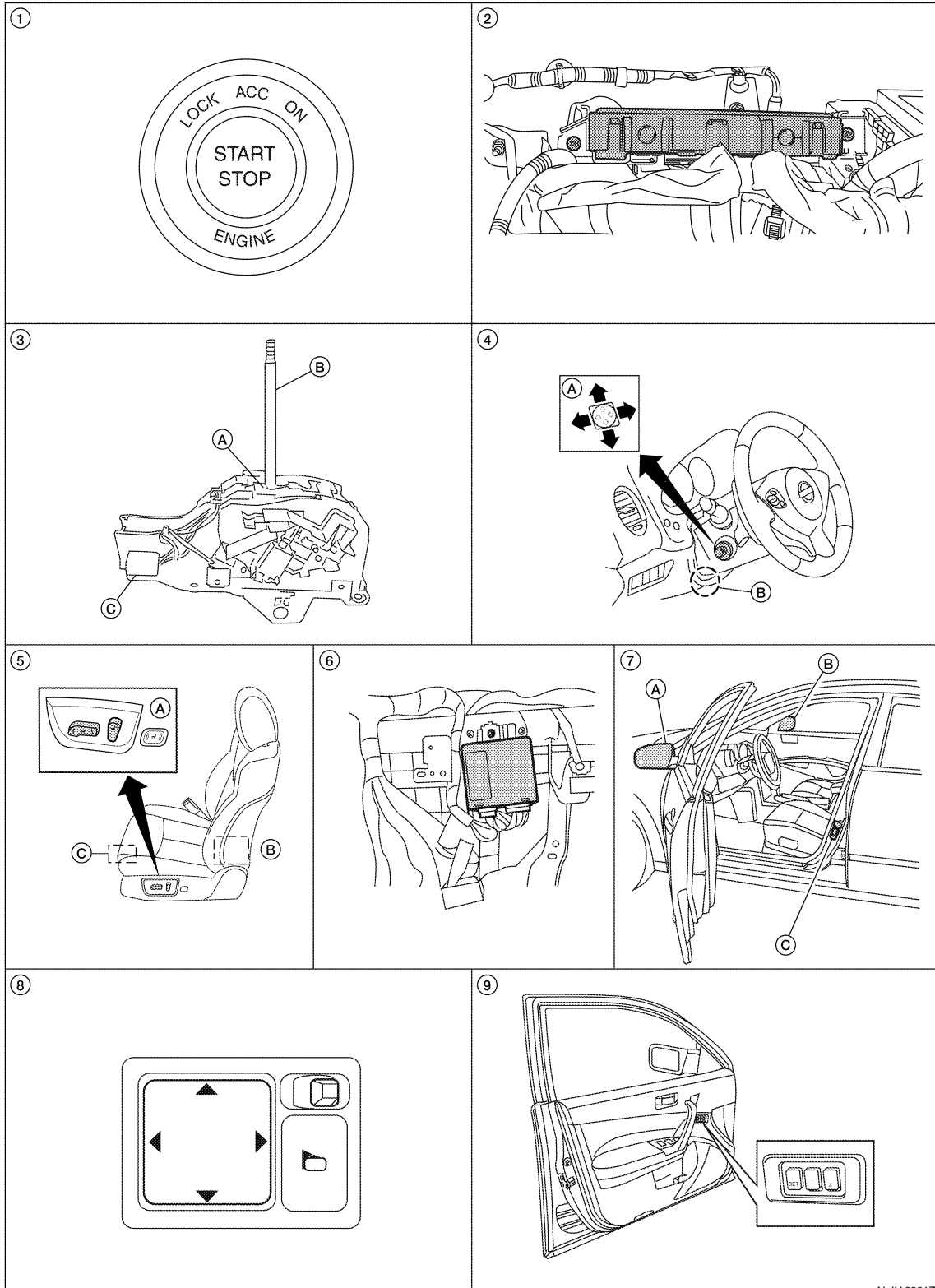

A  
B  
C  
D  
E  
F  
G  
H  
I  
ADP  
K  
L  
M  
N  
O  
P

ALJJA0361Z2

# AUTOMATIC DRIVE POSITIONER SYSTEM

## < FUNCTION DIAGNOSIS >

- |   |  |  |
|---|--|--|
| 1. Push-button ignition switch M38  | 2. BCM M16, M17, M18, M19 (view with instrument panel removed)                                       | 3. A. CVT device<br>B. CVT selector lever<br>C. CVT device (park position switch) M78    |
| 4. A. ADP steering switch M39<br>B. Tilt motor M71, telescopic motor M73        | 5. A. Power seat switch LH B213<br>B. Reclining motor B222<br>C. Driver seat control unit B203, B211 | 6. Automatic drive positioner control unit M63, M67 (view with instrument panel removed) |
| 7. A. Door mirror LH D4<br>B. Door mirror RH D107<br>C. Front door switch LH B8 | 8. Door mirror remote control switch M108  | 9. Seat memory switch D13  |

## AUTOMATIC DRIVE POSITIONER SYSTEM : Component Description

INFOID:000000003900243

### CONTROL UNITS

Item	Function
Driver seat control unit	<ul style="list-style-type: none"> <li>Main unit of automatic drive positioner system</li> <li>It is connected to the CAN.</li> <li>It communicates with the automatic drive positioner control unit via UART communication.</li> </ul>
Automatic drive positioner control unit	<ul style="list-style-type: none"> <li>It communicates with the driver seat control unit via UART communication.</li> <li>Perform various controls with the instructions of driver seat control unit.</li> <li>Perform the controls of the pedal adjusting, door mirror and the seat memory switch.</li> </ul>
BCM	Transmit the following status to the driver seat control unit via CAN communication. <ul style="list-style-type: none"> <li>Front door LH: OPEN/CLOSE</li> <li>Ignition switch position: ACC/ON</li> <li>Door lock: UNLOCK (with Intelligent Key or remote keyless entry request switch operation)</li> <li>Key ID</li> <li>Key switch: Insert/Pull out Intelligent Key</li> <li>Starter: CRANKING/OTHER</li> <li>Electronic steering column lock status: Lock/Unlock</li> </ul>
Combination meter	Transmit the vehicle speed signal to the driver seat control unit via CAN communication.
AV control unit	The setting change of auto drive positioner system can be performed on the display.
CVT device (park position switch)	Transmit the shift position signal (P range) to the driver seat control unit.

### INPUT PARTS

#### Switches

Item	Function
Key slot	The key switch is installed to detect the key inserted/removed status.
Front door switch LH	Detect front door (driver side) open/close status.
CVT device (park position switch)	Detect the P range position of CVT selector lever.
Set switch	The registration and system setting can be performed with its operation.
Seat memory switch 1/2	The registration and operation can be performed with its operation.
Power seat switch	The following switch is installed. <ul style="list-style-type: none"> <li>Reclining switch</li> <li>Lifting switch (front)</li> <li>Lifting switch (rear)</li> <li>Sliding switch</li> </ul> The specific parts can be operated with the operation of each switch.

# AUTOMATIC DRIVE POSITIONER SYSTEM

## < FUNCTION DIAGNOSIS >

Item	Function
ADP steering switch	The following switch is installed. <ul style="list-style-type: none"> <li>• Tilt switch</li> <li>• Telescopic switch</li> </ul> The specific parts can be operated with the operation of each switch.
Door mirror remote control switch	The following switch is installed. <ul style="list-style-type: none"> <li>• Mirror switch</li> <li>• Changeover switch</li> </ul> The specific parts can be operated with the operation of each switch.

### Sensors

Item	Function
Door mirror sensor (LH/RH)	Detect the up/down and left/right position of outside mirror face.
Tilt and telescopic sensors	Detect the up/down and front/rear position of steering column.
Lifting sensor (front)	Detect the up/down position of seat lifting (front).
Lifting sensor (rear)	Detect the up/down position of seat lifting (rear).
Reclining sensor	Detect the tilt of seatback.
Sliding sensor	Detect the front/rear position of seat.

### OUTPUT PARTS

Item	Function
Door mirror motor (LH/RH)	Move the outside mirror face up/down and left/right.
Tilt and telescopic motors	Move the steering column up/down and front/rear.
Lifting motor (front)	Move the seat lifting (front) up/down.
Lifting motor (rear)	Move the seat lifting (rear) up/down.
Reclining motor	Tilt and raise up the seatback.
Sliding motor	Slide the seat forward/backward.
Seat memory indicator	Illuminates or flashes according to the registration/operation status.

### MANUAL FUNCTION

A  
B  
C  
D  
E  
F  
G  
H  
I  
K  
L  
M  
N  
O  
P

ADP

# AUTOMATIC DRIVE POSITIONER SYSTEM

< FUNCTION DIAGNOSIS >

## MANUAL FUNCTION : System Diagram

INFOID:000000003900244

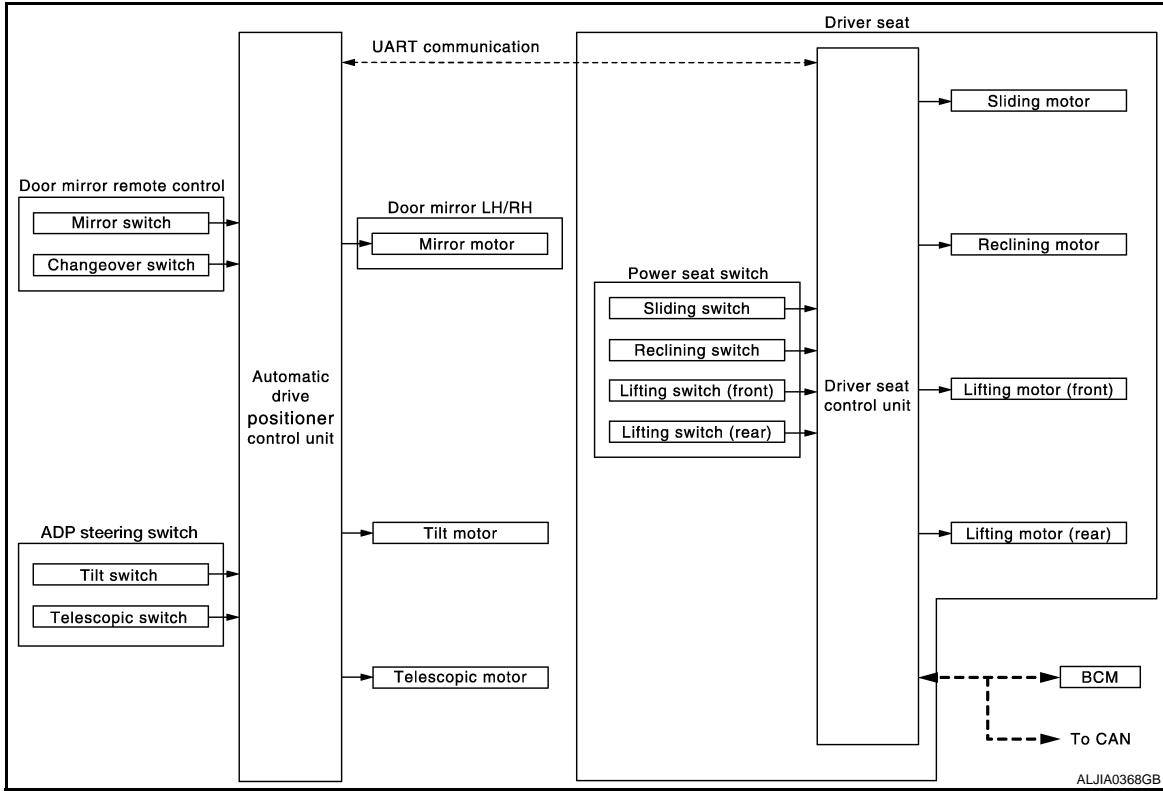

## MANUAL FUNCTION : System Description

INFOID:000000003900245

### OUTLINE

The driving position (seat, steering column and door mirror position) can be adjusted manually with power seat switch, ADP steering switch and door mirror remote control switch.

### OPERATION PROCEDURE

1. Turn ignition switch ON.
2. Operate power seat switch, ADP steering switch or door mirror remote control switch.
3. The driver seat, steering column or door mirror operates according to the operation of each switch.

### DETAIL FLOW

#### Seat

Order	Input	Output	Control unit condition
1	Power seat switch (sliding, lifting, reclining)	—	The power seat switch signal is inputted to the driver seat control unit when the power seat switch is operated.
2	—	Motors (sliding, lifting, reclining)	The driver seat control unit outputs signals to each motor according to the power seat switch input signal.

#### Tilt and Telescopic

Order	Input	Output	Control unit condition
1	ADP steering switch	—	The ADP steering switch signal is input to the automatic drive positioner control unit when the ADP steering switch is operated.

# AUTOMATIC DRIVE POSITIONER SYSTEM

## < FUNCTION DIAGNOSIS >

Order	Input	Output	Control unit condition
2	—	Motors (tilt, telescopic)	The automatic drive positioner control unit actuates the motors according to the operation of the ADP steering switch signal.
3	Sensors (tilt, telescopic)	—	The automatic drive positioner control unit recognizes any operation limit of each actuator via each sensor and will not operate the motors anymore at that time.

### Door Mirror

Order	Input	Output	Control unit condition
1	Door mirror remote control switch	—	The door mirror remote control switch signal is inputted to the automatic drive positioner control unit when the door mirror remote control switch is operated.
2	—	Motors (Door mirror motor)	The automatic drive positioner control unit actuates each motor according to the operation of the door mirror remote control switch.

#### NOTE:

The door mirrors can be operated manually when ignition switch is in either ACC or ON position. The ignition switch signal (ACC/ON) is transmitted from BCM to the driver seat control unit via CAN communication and from the driver seat control unit to the automatic drive positioner control unit via UART communication.

A  
B  
C  
D  
E  
F  
G  
H  
I  
K  
L  
M  
N  
O  
P

ADP

# AUTOMATIC DRIVE POSITIONER SYSTEM

< FUNCTION DIAGNOSIS >

## MANUAL FUNCTION : Component Parts Location

INFOID:000000004362974

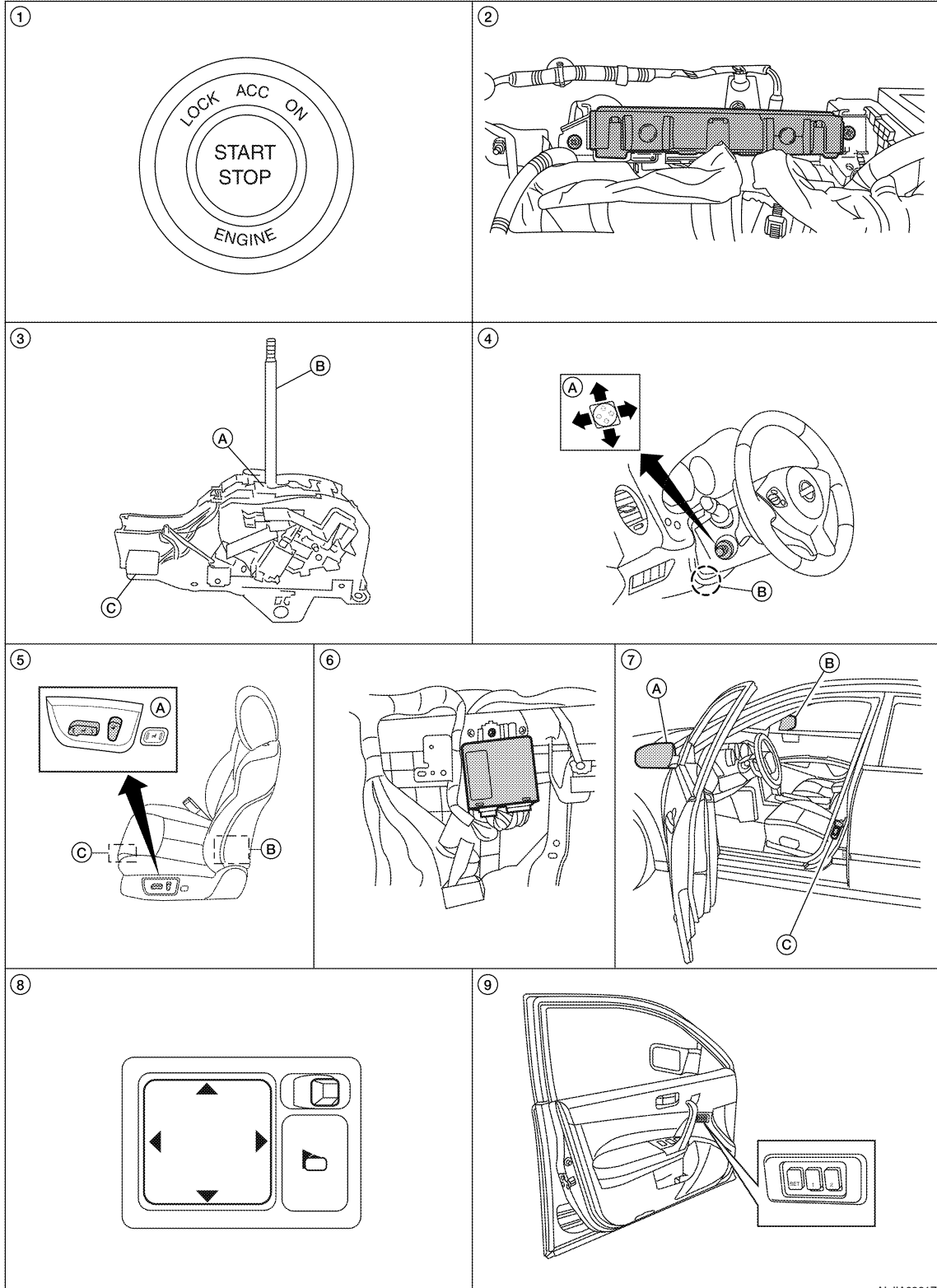

ALJIA0361Z2



# AUTOMATIC DRIVE POSITIONER SYSTEM

## < FUNCTION DIAGNOSIS >

- |   |  |  |
|---|--|--|
| 1. Push-button ignition switch M38  | 2. BCM M16, M17, M18, M19 (view with instrument panel removed)                                       | 3. A. CVT device<br>B. CVT selector lever<br>C. CVT device (park position switch) M78    |
| 4. A. ADP steering switch M39<br>B. Tilt motor M71, telescopic motor M73        | 5. A. Power seat switch LH B213<br>B. Reclining motor B222<br>C. Driver seat control unit B203, B211 | 6. Automatic drive positioner control unit M63, M67 (view with instrument panel removed) |
| 7. A. Door mirror LH D4<br>B. Door mirror RH D107<br>C. Front door switch LH B8 | 8. Door mirror remote control switch M108  | 9. Seat memory switch D13  |

A  
B  
C  
D  
E

## MANUAL FUNCTION : Component Description

INFOID:000000003900247

### CONTROL UNITS

Item	Function
Driver seat control unit	<ul style="list-style-type: none"> <li>Operates the specific seat motor with the signal from the power seat switch.</li> <li>Transmits the ignition switch signal (ACC/ON) via UART communication to the automatic drive positioner control unit.</li> </ul>
Automatic drive positioner control unit	Operates the specific motor with the signal from ADP steering switch or door mirror remote control switch.
BCM	Recognizes the following status and transmits it to the driver seat control unit via CAN communication. <ul style="list-style-type: none"> <li>Ignition position: ACC/ON</li> </ul>

F  
G  
H  
I

### INPUT PARTS

#### Switches

Item	Function
Power seat switch	The following switch is installed. <ul style="list-style-type: none"> <li>Reclining switch</li> <li>Lifting switch (front)</li> <li>Lifting switch (rear)</li> <li>Sliding switch</li> </ul> The specific parts can be operated with the operation of each switch.
ADP steering switch	The following switch is installed. <ul style="list-style-type: none"> <li>Tilt switch</li> <li>Telescopic switch</li> </ul> The specific parts can be operated with the operation of each switch.
Door mirror remote control switch	The following switch is installed. <ul style="list-style-type: none"> <li>Mirror switch</li> <li>Changeover switch</li> </ul> The specific parts can be operated with the operation of each switch.

ADP

K  
L  
M  
N

#### Sensors

Item	Function
Tilt and telescopic sensors	Detect the up/down and front/back position of steering column.

O  
P

### OUTPUT PARTS

Item	Function
Door mirror motor (LH/RH)	Move the outside mirror face up/down and left/right.
Tilt and telescopic motors	Move the steering column up/down and front/back.
Lifting motor (front)	Move the seat lifter (front) up/down.
Lifting motor (rear)	Move the seat lifter (rear) up/down.

# AUTOMATIC DRIVE POSITIONER SYSTEM

## < FUNCTION DIAGNOSIS >

Item	Function
Reclining motor	Tilt and raise up the seatback.
Sliding motor	Slide the seat forward/backward.

## MEMORY FUNCTION

### MEMORY FUNCTION : System Diagram

INFOID:000000003900248

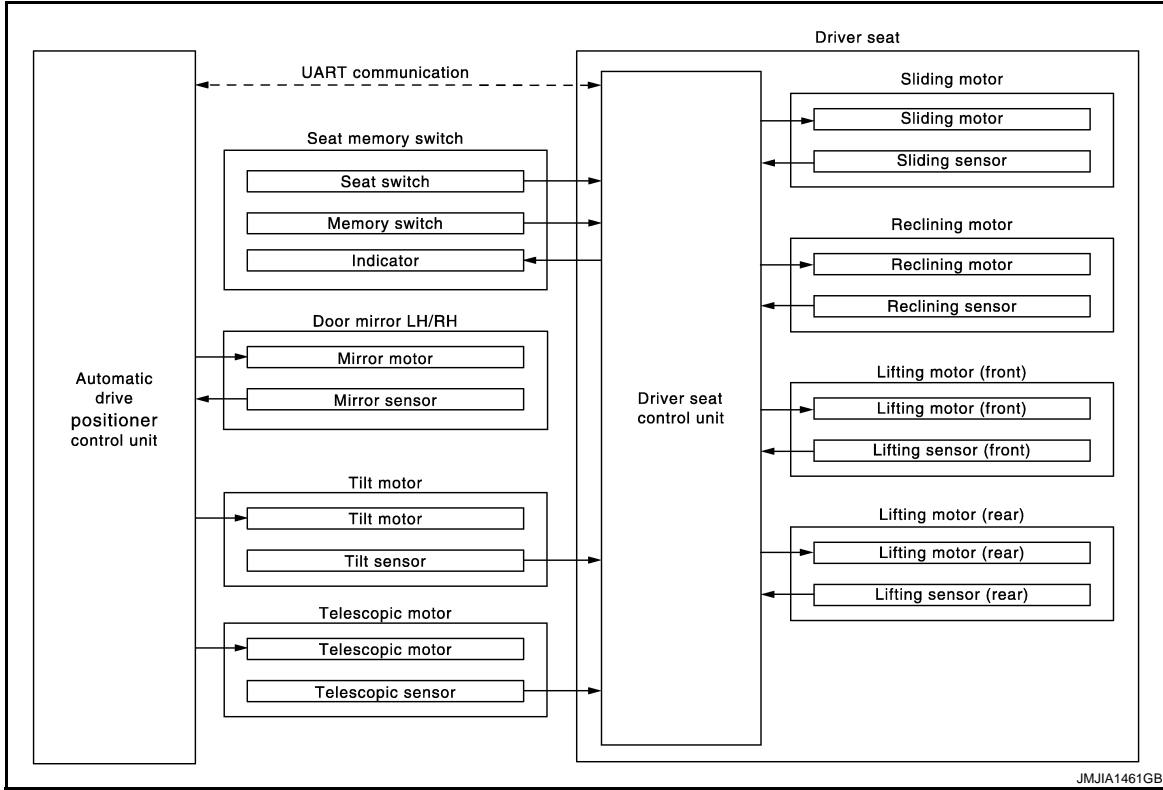

JMJA1461GB

### MEMORY FUNCTION : System Description

INFOID:000000003900249

#### OUTLINE

The driver seat control unit can store the optimum driving positions (seat, steering column and door mirror position) for 2 people. If the front seat position is changed, one-touch (pressing desired memory switch for more than 0.5 second) operation allows changing to the other driving position.

#### NOTE:

Further information for the memory storage procedure. Refer to Owner's Manual.

#### OPERATION PROCEDURE

1. Turn ignition switch ON
2. Press desired memory switch for more than 0.5 second.
3. Front seat LH, steering column and door mirror will move to the memorized position.

#### OPERATION CONDITION

Satisfy all of the following items. The memory function is not performed if these items are not satisfied.

Item	Request status
Ignition position	ON
Switch inputs <ul style="list-style-type: none"> <li>• Power seat switch</li> <li>• ADP steering switch</li> <li>• Door mirror control switch</li> <li>• Set switch</li> <li>• Seat memory switch</li> </ul>	OFF (Not operated)
CVT selector lever	P position

# AUTOMATIC DRIVE POSITIONER SYSTEM

## < FUNCTION DIAGNOSIS >

However, the memory operation can be performed for 45 seconds after opening the front door LH (front door switch LH OFF → ON) even if the ignition switch is OFF.

### DETAIL FLOW

Order	Input	Output	Control unit condition
1	Memory switch	—	The memory switch signal is inputted to the automatic drive positioner control unit when memory switch 1 or 2 is operated. Memory switch signal is input to driver seat control unit via UART communication.
2	—	Motors (seat, steering, door mirror)	Driver seat control unit operates each motor of seat when it recognizes the memory switch pressed for 0.5 second or more and requests each motor operation to automatic drive positioner control unit via UART communication. The automatic drive positioner control unit operates each motor.
		Memory switch Indicator	Driver seat control unit requests the flashing of memory indicator to automatic drive positioner control unit via UART communication while either of the motors is operating. The automatic drive positioner control unit illuminates the memory indicator.
3	Sensors (seat, steering column, door mirrors)	—	Driver seat control unit judges the operating seat position with each seat sensor input. The positions of the steering column and outside mirrors are monitored with each sensor signal that is input from auto drive positioner control unit via UART communication. Driver seat control unit stops the operation of each motor when each part reaches the recorded address.
4	—	Memory switch Indicator	Driver seat control unit requests the illumination of memory indicator to auto drive positioner control unit via UART communication after all motors stop. The auto driving positioner control unit illuminates the memory indicator for 5 seconds.

A  
B  
C  
D  
E  
F  
G  
H  
I  
K  
L  
M  
N  
O  
P

ADP

# AUTOMATIC DRIVE POSITIONER SYSTEM

< FUNCTION DIAGNOSIS >

## MEMORY FUNCTION : Component Parts Location

INFOID:000000004362975

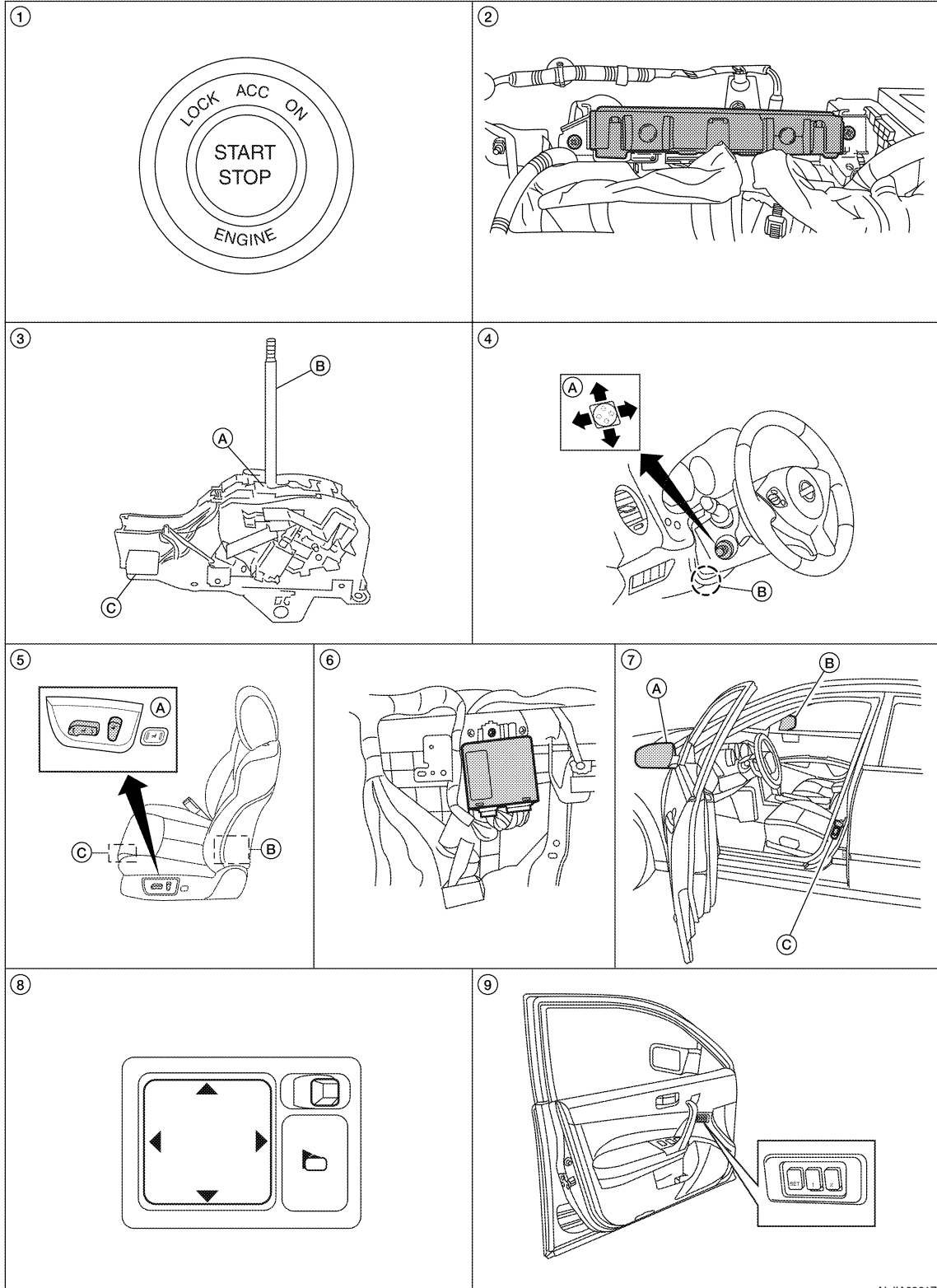

ALJIA0361Z2

# AUTOMATIC DRIVE POSITIONER SYSTEM

## < FUNCTION DIAGNOSIS >

- |   |  |  |
|---|--|--|
| 1. Push-button ignition switch M38  | 2. BCM M16, M17, M18, M19 (view with instrument panel removed)                                       | 3. A. CVT device<br>B. CVT selector lever<br>C. CVT device (park position switch) M78    |
| 4. A. ADP steering switch M39<br>B. Tilt motor M71, telescopic motor M73        | 5. A. Power seat switch LH B213<br>B. Reclining motor B222<br>C. Driver seat control unit B203, B211 | 6. Automatic drive positioner control unit M63, M67 (view with instrument panel removed) |
| 7. A. Door mirror LH D4<br>B. Door mirror RH D107<br>C. Front door switch LH B8 | 8. Door mirror remote control switch M108  | 9. Seat memory switch D13  |

A  
B  
C  
D  
E

## MEMORY FUNCTION : Component Description

INFOID:000000003900251

### CONTROL UNITS

Item	Function
Driver seat control unit	<ul style="list-style-type: none"> <li>The address of each part is recorded.</li> <li>Operates each motor of seat to the registered position.</li> <li>Requests the operations of steering column and door mirrors to automatic drive positioner control unit</li> </ul>
Automatic drive positioner control unit	Operates the steering column and door mirrors with the instructions from the driver seat control unit.

F  
G

### INPUT PARTS

#### Switches

Item	Function
Memory switch 1/2	The registration and memory function can be performed with its operation.

H  
I

#### Sensors

Item	Function
Door mirror sensor (LH/RH)	Detect the up/down and left/right position of outside mirror face.
Tilt and telescopic sensors	Detect the up/down and front/rear position of steering column.
Lifting sensor (front)	Detect the up/down position of seat lifting (front).
Lifting sensor (rear)	Detect the up/down position of seat lifting (rear).
Reclining sensor	Detect the tilt of seatback.
Sliding sensor	Detect the front/rear position of seat.

ADP

K  
L  
M

### OUTPUT PARTS

Item	Function
Door mirror motor (LH/RH)	Move the outside mirror face upward/downward and leftward/rightward.
Tilt and telescopic motors	Move the steering column up/down and front/rear.
Lifting motor (front)	Move the seat lifter (front) upward/downward.
Lifting motor (rear)	Move the seat lifter (rear) upward/downward.
Reclining motor	Tilt and raise up the seatback.
Sliding motor	Slide the seat forward/backward.
Memory indicator	Illuminates or blinks according to the registration/operation status.

N  
O  
P

### EXIT ASSIST FUNCTION

# AUTOMATIC DRIVE POSITIONER SYSTEM

< FUNCTION DIAGNOSIS >

## EXIT ASSIST FUNCTION : System Diagram

INFOID:000000003900252

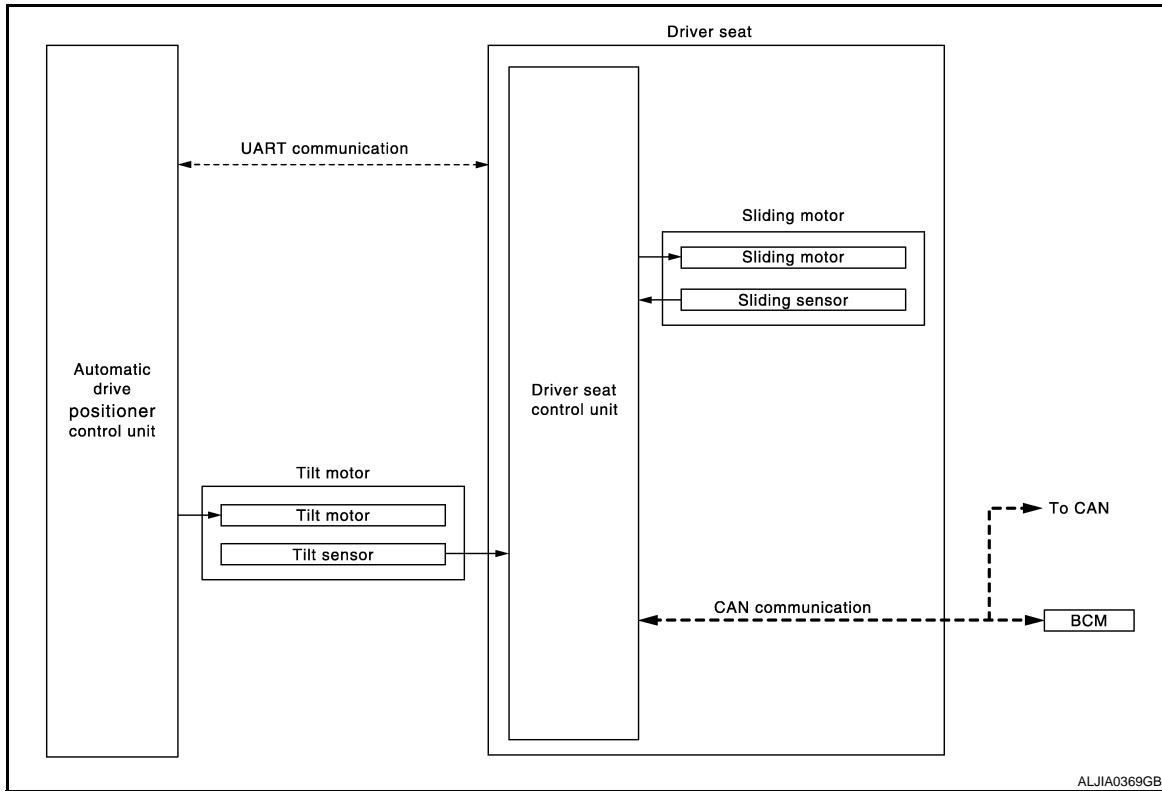

ALJIA0369GB

## EXIT ASSIST FUNCTION : System Description

INFOID:000000003900253

### OUTLINE

When exiting, if the conditions are satisfied, the seat is moved backward from normal sitting position and the steering column is moved up.

The seat slide amount at entry/exit operation can be changed.

### NOTE:

- This function is set to ON before delivery (initial setting).
- Further information for the system setting procedure. Refer to Owner's Manual.

### OPERATION PROCEDURE

1. Open the front door LH with ignition switch in OFF position.
2. Front seat LH and steering column will move to the exiting position.

### OPERATION CONDITION

Satisfy all of the following items. The exit assist function is not performed if these items are not satisfied.

Item	Request status
Ignition switch	OFF
System setting [Entry/exit assist function]	ON
Initialization	Done
Switch inputs <ul style="list-style-type: none"> <li>• Power seat switch</li> <li>• ADP steering switch</li> <li>• Door mirror remote control switch</li> <li>• Set switch</li> <li>• Seat memory switch</li> </ul>	OFF (Not operated)
CVT selector lever	P position

### DETAIL FLOW

# AUTOMATIC DRIVE POSITIONER SYSTEM

## < FUNCTION DIAGNOSIS >

Order	Input	Output	Control unit condition
1	Front door switch LH	—	Driver seat control unit receives front door switch LH signal (open) from BCM via CAN communication.
2	—	Motors (seat sliding, tilt)	Driver seat control unit operates the seat sliding motor, which recognizes that the driver side door is opened with ignition switch OFF. Driver seat control unit then requests the operations of tilt motor to auto drive positioner control unit via UART communication. The automatic drive positioner control unit operates each motor for a constant amount.

A

B

C

D

E

F

G

H

I

ADP

K

L

M

N

O

P

# AUTOMATIC DRIVE POSITIONER SYSTEM

< FUNCTION DIAGNOSIS >

## EXIT ASSIST FUNCTION : Component Parts Location

INFOID:000000004362976

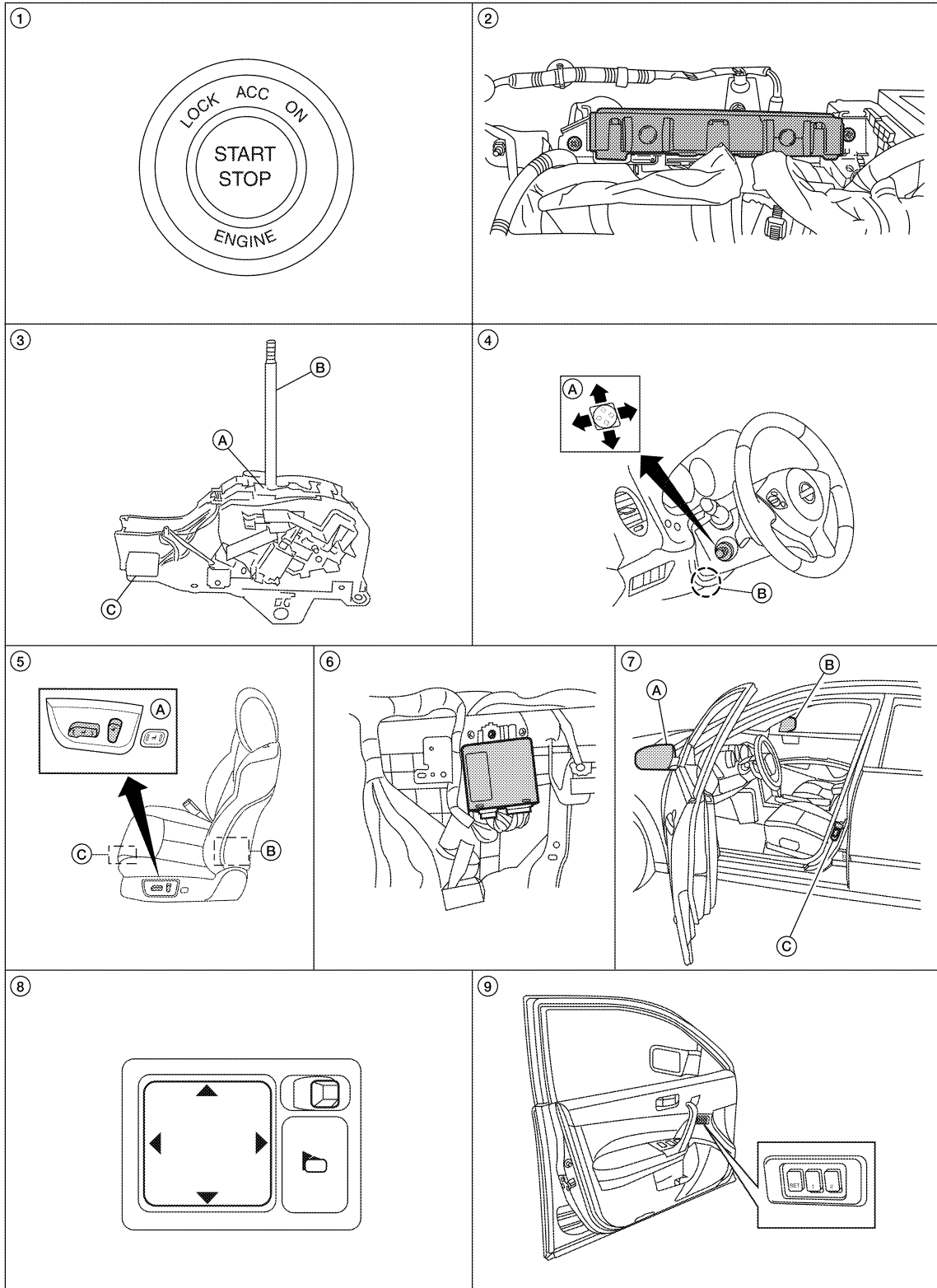

ALJIA0361Z2



# AUTOMATIC DRIVE POSITIONER SYSTEM

## < FUNCTION DIAGNOSIS >

- |   |  |  |
|---|--|--|
| 1. Push-button ignition switch M38  | 2. BCM M16, M17, M18, M19 (view with instrument panel removed)                                       | 3. A. CVT device<br>B. CVT selector lever<br>C. CVT device (park position switch) M78    |
| 4. A. ADP steering switch M39<br>B. Tilt motor M71, telescopic motor M73        | 5. A. Power seat switch LH B213<br>B. Reclining motor B222<br>C. Driver seat control unit B203, B211 | 6. Automatic drive positioner control unit M63, M67 (view with instrument panel removed) |
| 7. A. Door mirror LH D4<br>B. Door mirror RH D107<br>C. Front door switch LH B8 | 8. Door mirror remote control switch M108  | 9. Seat memory switch D13  |

A  
B  
C  
D  
E  
F  
G  
H  
I  
K  
L  
M  
N  
O  
P

## EXIT ASSIST FUNCTION : Component Description

INFOID:000000003900255

### CONTROL UNITS

Item	Function
Driver seat control unit	<ul style="list-style-type: none"> <li>Operates the seat sliding motor for a constant amount.</li> <li>Requests operation of the tilt motor from the automatic drive positioner control unit.</li> </ul>
Automatic drive positioner control unit	Operates the tilt motor with the request from the driver seat control unit.
BCM	Recognizes the following status and transmits it to the driver seat control unit via CAN communication. <ul style="list-style-type: none"> <li>Front door LH: OPEN/CLOSE</li> <li>Key switch signal</li> <li>Ignition switch signal</li> </ul>

### INPUT PARTS

#### Switches

Item	Function
Front door switch LH	Detect front door LH open/close status.

#### Sensors

Item	Function
Tilt sensor	Detect the up/down position of steering column.
Sliding sensor	Detect the front/rear position of seat.

### OUTPUT PARTS

Item	Function
Tilt motor	Move the steering column up/down.
Sliding motor	Slide the seat forward/backward.

## ENTRY ASSIST FUNCTION

# AUTOMATIC DRIVE POSITIONER SYSTEM

< FUNCTION DIAGNOSIS >

## ENTRY ASSIST FUNCTION : System Diagram

INFOID:000000003900256

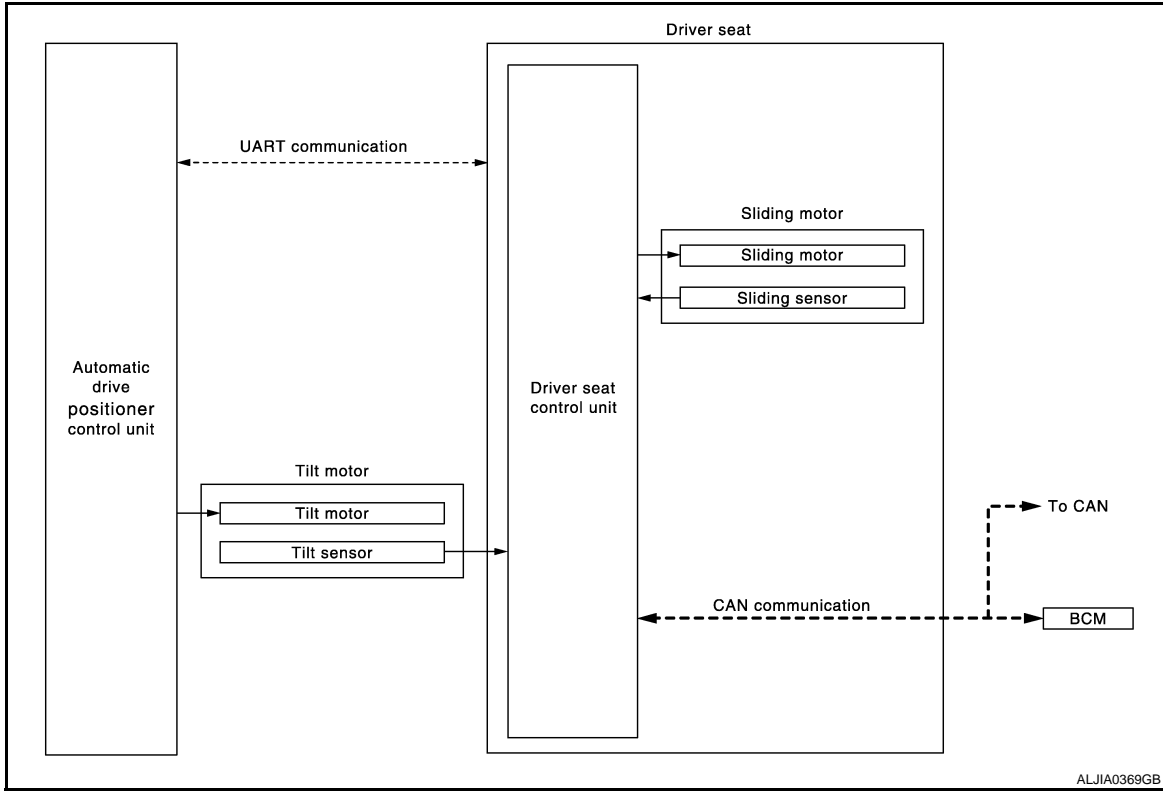

## ENTRY ASSIST FUNCTION : System Description

INFOID:000000003900257

### OUTLINE

The seat is in the exiting position when either following condition is satisfied, the seat returns from exiting position to the previous driving position.

#### NOTE:

- This function is set to OFF before delivery (initial setting).
- Further information for the system setting procedure. Refer to Owner's Manual.

### OPERATION PROCEDURE

1. Turn the ignition switch to ACC.
2. Front seat LH and steering column will return from the exiting position to entry position.

### OPERATION CONDITION

Satisfy all of the following items. The entry assist function is not performed if these items are not satisfied.

Item	Request status
Seat, steering column	The vehicle is not moved after performing the exit assist function.
Switch inputs <ul style="list-style-type: none"> <li>• Power seat switch</li> <li>• ADP steering switch</li> <li>• Door mirror control switch</li> <li>• Set switch</li> <li>• Memory switch</li> </ul>	OFF (Not operated)
CVT selector lever	P position

### DETAIL FLOW

# AUTOMATIC DRIVE POSITIONER SYSTEM

## < FUNCTION DIAGNOSIS >

Order	Input	Output	Control unit condition
1	Door switch/Ignition switch	—	Driver seat control unit receives the signals of ignition switch signal and front door switch from BCM via CAN communication.
2	—	Motors (sliding, tilt)	Driver seat control unit operates the sliding motor when the operating conditions are satisfied and requests the operation of tilt motor to automatic drive positioner control unit via UART communication. The automatic drive positioner control unit operates the tilt motor.
	Sensors (sliding, tilt)	—	Each sensor monitors the operating positions of seat and steering column, then stops the operation of motor when each part reaches the recorded address.

A  
B  
C  
D  
E  
F  
G  
H  
I  
K  
L  
M  
N  
O  
P

ADP

# AUTOMATIC DRIVE POSITIONER SYSTEM

< FUNCTION DIAGNOSIS >

## ENTRY ASSIST FUNCTION : Component Parts Location

INFOID:000000004362977

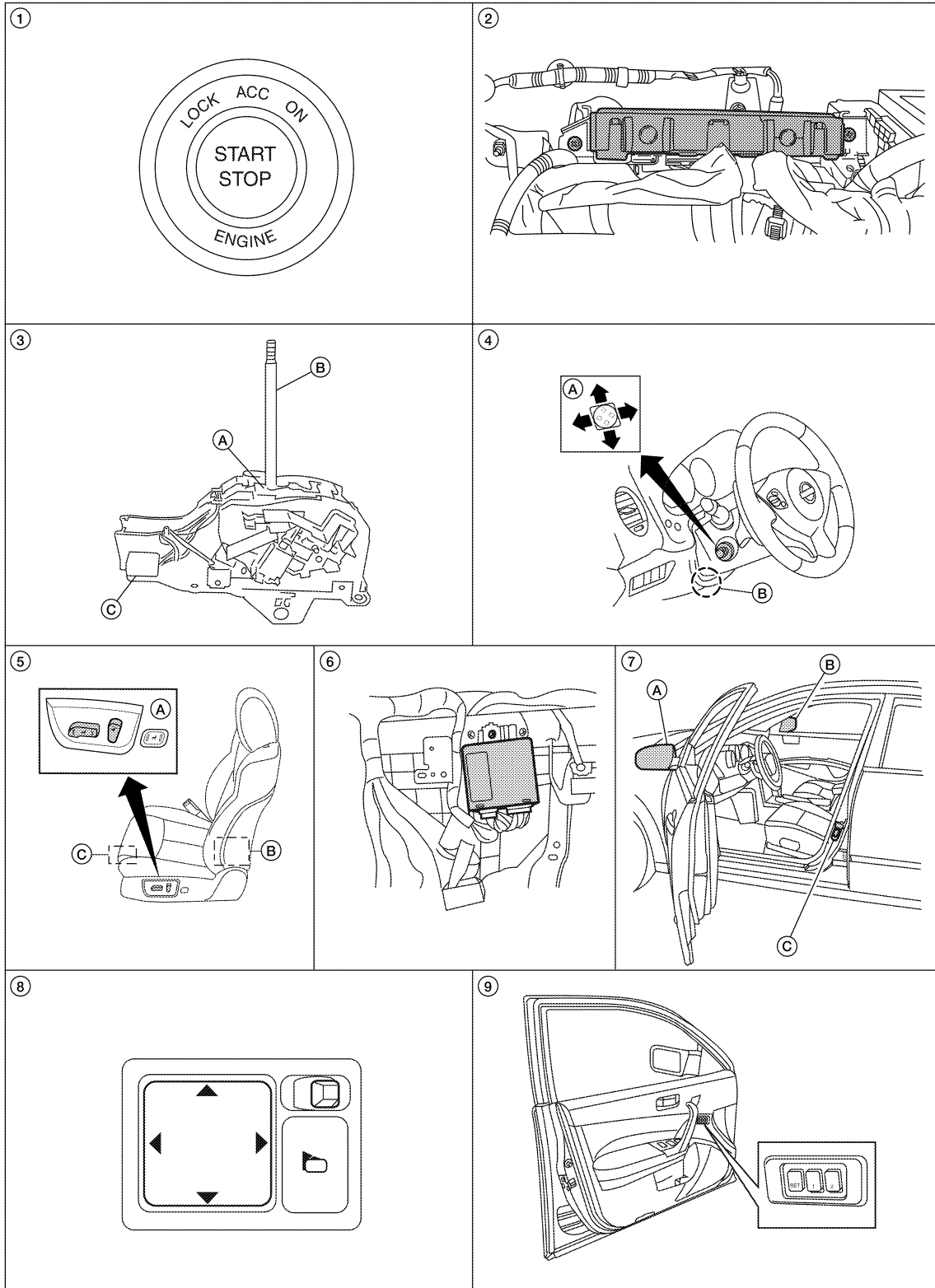

ALJIA0361Z2

# AUTOMATIC DRIVE POSITIONER SYSTEM

## < FUNCTION DIAGNOSIS >

- |   |  |  |
|---|--|--|
| 1. Push-button ignition switch M38  | 2. BCM M16, M17, M18, M19 (view with instrument panel removed)                                       | 3. A. CVT device<br>B. CVT selector lever<br>C. CVT device (park position switch) M78    |
| 4. A. ADP steering switch M39<br>B. Tilt motor M71, telescopic motor M73        | 5. A. Power seat switch LH B213<br>B. Reclining motor B222<br>C. Driver seat control unit B203, B211 | 6. Automatic drive positioner control unit M63, M67 (view with instrument panel removed) |
| 7. A. Door mirror LH D4<br>B. Door mirror RH D107<br>C. Front door switch LH B8 | 8. Door mirror remote control switch M108  | 9. Seat memory switch D13  |

A  
B  
C  
D  
E

## ENTRY ASSIST FUNCTION : Component Description

INFOID:000000003900259

### CONTROL UNITS

Item	Function
Driver seat control unit	According to the ignition signal and front door switch LH signal from BCM, <ul style="list-style-type: none"> <li>• Operates the seat sliding motor for a constant amount.</li> <li>• Requests the operation of tilt motor to automatic drive positioner control unit.</li> </ul>
Automatic drive positioner control unit	Operates the tilt motor with the instructions from the driver seat control unit.
BCM	Recognizes the following status and transmits it to the driver seat control unit via CAN communication. <ul style="list-style-type: none"> <li>• Front door LH: OPEN/CLOSE</li> <li>• Ignition switch position: ACC/ON</li> </ul>

F  
G  
H  
I

### INPUT PARTS

#### Switches

Item	Function
Front door switch LH	Detect front door LH open/close status.

I

ADP

#### Sensors

Item	Function
Tilt sensor	Detect the up/down position of steering column.
Sliding sensor	Detect the front/rear position of seat.

K  
L

### OUTPUT PARTS

Item	Function
Tilt motor	Move the steering column up/down.
Sliding motor	Slide the seat forward/backward.

M  
N

## INTELLIGENT KEY INTERLOCK FUNCTION

O  
P

# AUTOMATIC DRIVE POSITIONER SYSTEM

< FUNCTION DIAGNOSIS >

## INTELLIGENT KEY INTERLOCK FUNCTION : System Diagram

INFOID:000000004363647

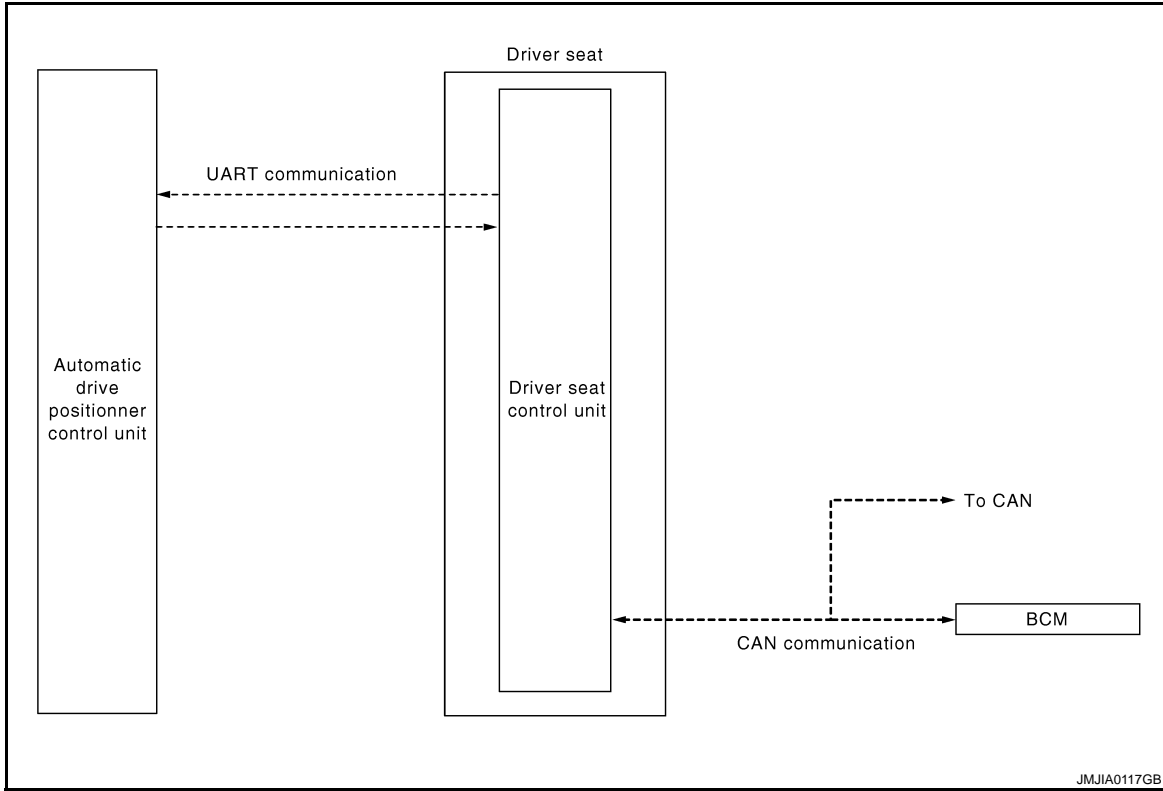

JMJIA0117GB

## INTELLIGENT KEY INTERLOCK FUNCTION : System Description

INFOID:000000004363648

### OUTLINE

When unlocking doors by using Intelligent Key or door request switch (driver side), seat slide and steering tilt move directly to the exit assist function.  
 Other loads move to the exit assist function after performing memory function.  
 Then performs the entry assist function.

### OPERATION PROCEDURE

1. Unlock doors by using Intelligent Key or door request switch (driver side) .
2. The system performs exit assist operation and memory operation.

#### NOTE:

Further information for Intelligent Key interlock function. Refer to Owner's Manual.

### OPERATION CONDITION

Satisfy all of the following items. The Intelligent Key interlock function is not performed if these items are not satisfied.

Item	Request status
Ignition position	OFF
Electronic steering column lock	LOCK
Switch inputs <ul style="list-style-type: none"> <li>• Power seat switch LH</li> <li>• ADP steering switch</li> <li>• Door mirror remote control switch</li> <li>• Set switch</li> <li>• Seat memory switch</li> </ul>	OFF (Not operated)
CVT selector lever	P position

### DETAIL FLOW

# AUTOMATIC DRIVE POSITIONER SYSTEM

## < FUNCTION DIAGNOSIS >

Order	Input	Output	Control unit condition
1	<ul style="list-style-type: none"><li>• Door unlock signal (CAN)</li><li>• Key ID signal (CAN)</li></ul>	—	Driver seat control unit receives the door unlock signal and the key ID signal from BCM when unlocking the door with Intelligent Key or driver side door request switch.
2	—	—	Driver seat control unit performs the seat slide and steering tilt move directly to the exit assist function. Other loads move to the exit assist function after performing memory function.
3	—	—	Driver seat control unit performs the entry assist function.

A

B

C

D

E

F

G

H

I

ADP

K

L

M

N

O

P

# AUTOMATIC DRIVE POSITIONER SYSTEM

< FUNCTION DIAGNOSIS >

## INTELLIGENT KEY INTERLOCK FUNCTION : Component Parts Location

INFOID:000000004363651

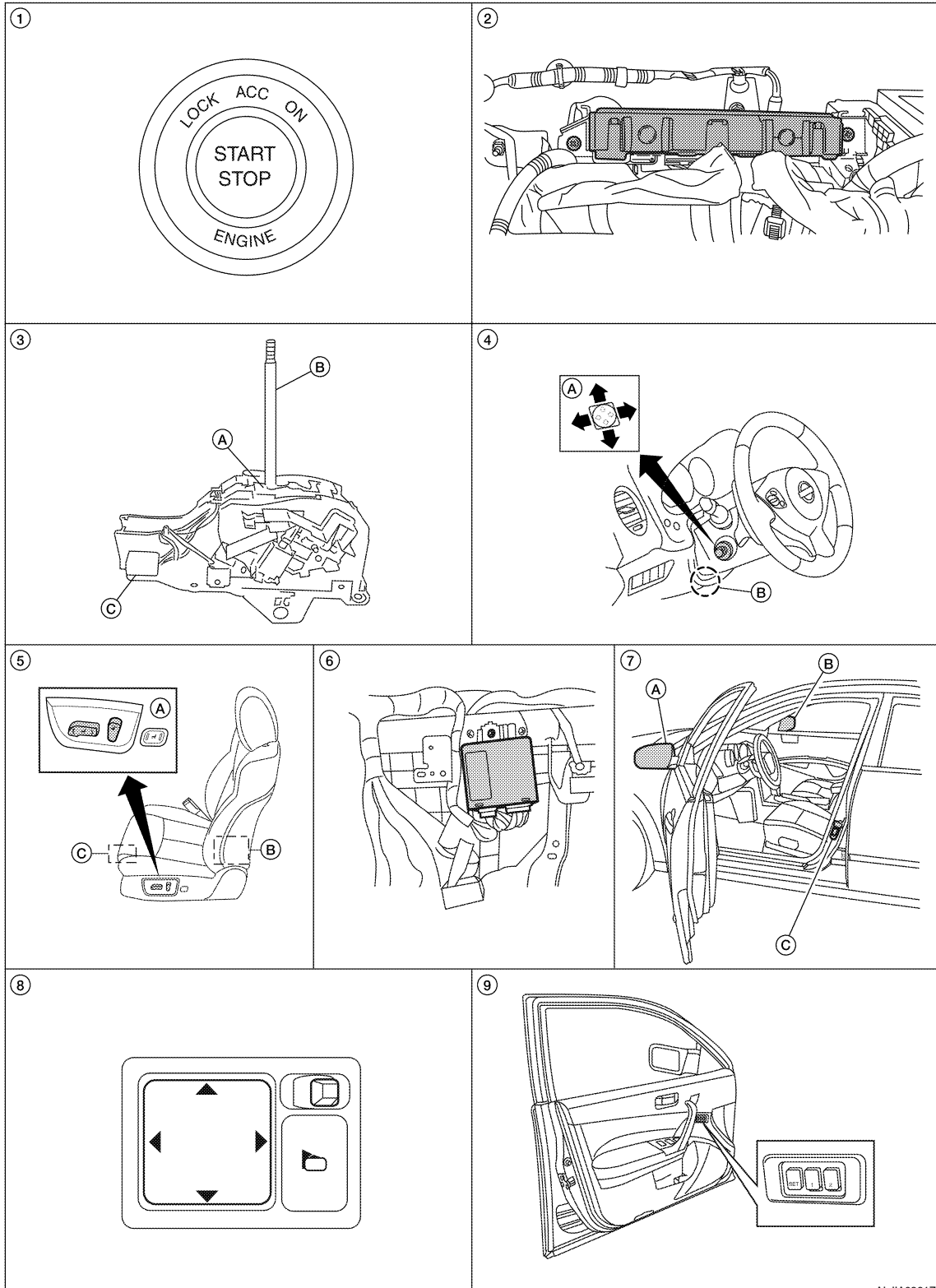

ALJIA0361Z2



# AUTOMATIC DRIVE POSITIONER SYSTEM

## < FUNCTION DIAGNOSIS >

- |   |  |  |   |
|---|--|--|---|
| 1. Push-button ignition switch M38  | 2. BCM M16, M17, M18, M19 (view with instrument panel removed)                                       | 3. A. CVT device<br>B. CVT selector lever<br>C. CVT device (park position switch) M78    | A |
| 4. A. ADP steering switch M39<br>B. Tilt motor M71, telescopic motor M73        | 5. A. Power seat switch LH B213<br>B. Reclining motor B222<br>C. Driver seat control unit B203, B211 | 6. Automatic drive positioner control unit M63, M67 (view with instrument panel removed) | B |
| 7. A. Door mirror LH D4<br>B. Door mirror RH D107<br>C. Front door switch LH B8 | 8. Door mirror remote control switch M108  | 9. Seat memory switch D13  | C |

## INTELLIGENT KEY INTERLOCK FUNCTION : Component Description

INFOID:000000004363650

### CONTROL UNITS

Item	Function
Driver seat control unit	It performs memory function and entry/exit assist function after receiving the door unlock signal from BCM.
Automatic drive positioner control unit	Operates the steering column and door mirrors with the instructions from the driver seat control unit.
BCM	Recognizes the following status and transmits it to the driver seat control unit via CAN communication. <ul style="list-style-type: none"> <li>• Door lock: UNLOCK (with Intelligent Key or driver side door request switch)</li> <li>• Key ID signal</li> <li>• Ignition switch signal</li> </ul>

A  
B  
C  
D  
E  
F  
G  
H  
I  
K  
L  
M  
N  
O  
P

ADP

## DIAGNOSIS SYSTEM (DRIVER SEAT C/U)

< FUNCTION DIAGNOSIS >

### DIAGNOSIS SYSTEM (DRIVER SEAT C/U)

#### Diagnosis Description

INFOID:000000003900260

The auto drive positioner system can be checked and diagnosed for component operation with CONSULT-III.

#### DIAGNOSTIC MODE

Diagnostic mode [AUTO DRIVE POS.]	Description
WORK SUPPORT	Changes the setting of each function.
SELF-DIAG RESULTS	Performs self-diagnosis for the auto drive positioner system and displays the results.
DATA MONITOR	Displays input signals transmitted from various switches and sensors to driver seat control unit in real time.
CAN DIAG SUPPORT MNTR	The result of transmit/receive diagnosis of CAN communication can be read.
ACTIVE TEST	Drive each output device.
ECU PART NUMBER	Displays part numbers of driver seat control unit parts.

#### CONSULT-III Function (AUTO DRIVE POS.)

INFOID:000000003900261

#### SELF-DIAGNOSIS RESULTS

Refer to [ADP-132, "DTC Index"](#).

#### DATA MONITOR

Monitor Item	Unit	Main Signals	Selection From Menu	Contents
SET SW	"ON/OFF"	×	×	ON/OFF status judged from the setting switch signal.
MEMORY SW1	"ON/OFF"	×	×	ON/OFF status judged from the seat memory switch 1 signal.
MEMORY SW2	"ON/OFF"	×	×	ON/OFF status judged from the seat memory switch 2 signal.
SLIDE SW-FR	"ON/OFF"	×	×	ON/OFF status judged from the sliding switch (forward) signal.
SLIDE SW-RR	"ON/OFF"	×	×	ON/OFF status judged from the sliding switch (backward) signal.
RECLN SW-FR	"ON/OFF"	×	×	ON/OFF status judged from the reclining switch (forward) signal.
RECLN SW-RR	"ON/OFF"	×	×	ON/OFF status judged from the reclining switch (backward) signal.
LIFT FR SW-UP	"ON/OFF"	×	×	ON/OFF status judged from the lifting switch front (up) signal.
LIFT FR SW-DN	"ON/OFF"	×	×	ON/OFF status judged from the lifting switch front (down) signal.
LIFT RR SW-UP	"ON/OFF"	×	×	ON/OFF status judged from the lifting switch rear (up) signal.
LIFT RR SW-DN	"ON/OFF"	×	×	ON/OFF status judged from the lifting switch rear (down) signal.
MIR CON SW-UP	"ON/OFF"	×	×	ON/OFF status judged from the mirror switch (up) signal.
MIR CON SW-DN	"ON/OFF"	×	×	ON/OFF status judged from the mirror switch (down) signal.
MIR CON SW-RH	"ON/OFF"	×	×	ON/OFF status judged from the door mirror remote control switch (passenger side) signal.
MIR CON SW-LH	"ON/OFF"	×	×	ON/OFF status judged from the door mirror remote control switch (driver side) signal.

## DIAGNOSIS SYSTEM (DRIVER SEAT C/U)

### < FUNCTION DIAGNOSIS >

Monitor Item	Unit	Main Signals	Selection From Menu	Contents
MIR CHNG SW-R	"ON/OFF"	×	×	ON/OFF status judged from the door mirror remote control switch (switching to right) signal.
MIR CHNG SW-L	"ON/OFF"	×	×	ON/OFF status judged from the door mirror remote control switch (switching to left) signal.
TILT SW-UP	"ON/OFF"	×	×	ON/OFF status judged from the ADP steering switch (up) signal.
TILT SW-DOWN	"ON/OFF"	×	×	ON/OFF status judged from the ADP steering switch (down) signal.
TELESCO SW-FR	"ON/OFF"	×	×	ON/OFF status judged from the ADP steering switch (forward) signal.
TELESCO SW-RR	"ON/OFF"	×	×	ON/OFF status judged from the ADP steering switch (backward) signal.
DETENT SW	"ON/OFF"	×	×	The selector lever position "OFF (P position) / ON (other than P position)" judged from the detention switch signal.
STARTER SW	"ON/OFF"	×	×	Ignition key switch ON (START, ON) /OFF (ACC, OFF) status judged from the ignition switch signal.
SLIDE PULSE	—	—	×	Value (32768) when battery connections are standard. If it moves backward, the value increases. If it moves forward, the value decreases.
RECLN PULSE	—	—	×	Value (32768) when battery connections are standard. If it moves backward, the value increases. If it moves forward, the value decreases.
LIFT FR PULSE	—	—	×	Value (32768) when battery connections are standard. If it moves DOWN, the value increases. If it moves UP, the value decreases.
LIFT RR PULSE	—	—	×	Value (32768) when battery connections are standard. If it moves DOWN, the value increases. If it moves UP, the value decreases.
MIR/SEN RH U-D	"V"	—	×	Voltage input from door mirror sensor (passenger side) up/down is displayed.
MIR/SEN RH R-L	"V"	—	×	Voltage input from door mirror sensor (passenger side) left/right is displayed.
MIR/SEN LH U-D	"V"	—	×	Voltage input from door mirror sensor (driver side) up/down is displayed.
MIR/SEN LH R-L	"V"	—	×	Voltage input from door mirror sensor (driver side) left/right is displayed.
TILT PULSE	—	—	×	Value (32768) when battery connections are standard. If it moves DOWN, the value increases. If it moves UP, the value decreases.
TELESCO PULSE	—	—	×	Value (32768) when battery connections are standard. If it moves backward, the value increases. If it moves forward, the value decreases.
VEHICLE SPEED	—	×	×	Display the vehicle speed signal received from combination meter by numerical value [km/h].
P RANG SW CAN	"ON/OFF"	×	×	ON/OFF status judged from the P range switch signal.
R RANGE (CAN)	"ON/OFF"	×	×	ON/OFF status judged from the R range switch signal.
DOOR SW-FL	"ON/OFF"	×	×	ON/OFF status judged from the door switch (front driver side) signal.
DOOR SW-FR	"ON/OFF"	×	×	ON/OFF status judged from the door switch (front passenger side) signal.
IGN ON SW	"ON/OFF"	×	×	ON/OFF status judged from the ignition switch signal.
ACC ON SW	"ON/OFF"	×	×	ON/OFF status judged from the ACC switch signal.

A

B

C

D

E

F

G

H

I

ADP

K

L

M

N

O

P

## DIAGNOSIS SYSTEM (DRIVER SEAT C/U)

### < FUNCTION DIAGNOSIS >

Monitor Item	Unit	Main Signals	Selection From Menu	Contents
KEY ON SW	"ON/OFF"	×	×	ON/OFF status judged from the key on switch signal.
KEYLESS ID	—	×	×	Key ID status judged from the key ID signal.
KYLS DR UNLK	"ON/OFF"	×	×	ON/OFF status judged from the driver side door unlock actuator output switch signal.
VHCL SPEED (ABS)	"ON/OFF"	×	×	ON/OFF status judged from vehicle speed signal.
HANDLE	"RHD/LHD"	×	×	RHD/LHD status judged from handle position signal.
TRANSMISSION	"CVT"	×	×	CVT status judged from transmission.
STEERING STATUS	"LOCK/UNLOCK"	×	×	LOCK/UNLOCK status judged from electronic steering column lock.

### ACTIVE TEST

#### CAUTION:

**When driving vehicle, do not perform active test.**

Test item	Description
SEAT SLIDE	Activates/deactivates the sliding motor.
SEAT RECLINING	Activates/deactivates the reclining motor.
SEAT LIFTER FR	Activates/deactivates the lifting motor (front).
SEAT LIFTER RR	Activates/deactivates the lifting motor (rear).
TILT MOTOR	Activates/deactivates the tilt motor.
TELESCO MOTOR	Activates/deactivates the telescopic motor.
MIRROR MOTOR RH	Activates/deactivates the mirror motor (passenger side).
MIRROR MOTOR LH	Activates/deactivates the mirror motor (driver side).
MEMORY SW INDCTR	Turns ON/OFF the memory indicator.

### WORK SUPPORT

Work item	Content	Item
SEAT SLIDE VOLUME SET	The amount of seat sliding for entry/exit assist can be selected from 3 items.	40 mm (1.6 in)
		80 mm (3.1 in)
		150 mm (6 in)
EXIT TILT SETTING	Entry/exit assist (steering column) can be selected: ON (operated) – OFF (not operated)	ON
		OFF
EXIT SEAT SLIDE SETTING	Entry/exit assist (seat) can be selected: ON (operated) – OFF (not operated)	ON
		OFF

# U1000 CAN COMM CIRCUIT

< COMPONENT DIAGNOSIS >

## COMPONENT DIAGNOSIS

### U1000 CAN COMM CIRCUIT

#### Description

INFOID:000000003900262

Refer to [LAN-24, "CAN Communication Signal Chart"](#).

#### DTC Logic

INFOID:000000003900263

#### DTC DETECTION LOGIC

DTC	Trouble diagnosis name	DTC detecting condition	Possible cause
U1000	CAN COMM CIRCUIT	<ul style="list-style-type: none"><li>• Driver seat control unit cannot communicate to other control units.</li><li>• Driver seat control unit cannot communicate for more than the specified time.</li></ul>	<ul style="list-style-type: none"><li>• Harness or connectors (CAN communication line is open or shorted)</li></ul>

#### DTC CONFIRMATION PROCEDURE

##### 1. STEP 1

Turn ignition switch ON and wait at least 3 seconds.

>> GO TO 2

##### 2. STEP 2

Check "Self diagnostic result" with CONSULT-III.

Is the DTC detected?

YES >> Perform diagnosis procedure. Refer to [ADP-37, "Diagnosis Procedure"](#).

NO >> Inspection End.

#### Diagnosis Procedure

INFOID:000000003900264

Refer to [LAN-15, "Trouble Diagnosis Flow Chart"](#).

#### Special Repair Requirement

INFOID:000000003900265

Refer to Owner's Manual.

A  
B  
C  
D  
E  
F  
G  
H  
I  
K  
L  
M  
N  
O  
P

ADP

# U1010 CONTROL UNIT (CAN)

< COMPONENT DIAGNOSIS >

## U1010 CONTROL UNIT (CAN)

### Description

INFOID:000000004363655

Refer to [LAN-24. "CAN Communication Signal Chart"](#).

### DTC Logic

INFOID:000000004363656

### DTC DETECTION LOGIC

DTC No.	Trouble diagnosis name	DTC detecting condition	Possible cause
U1010	CONTROL UNIT (CAN)	When detecting error during the initial diagnosis of CAN controller of driver seat control unit.	<ul style="list-style-type: none"><li>• Driver seat control unit</li></ul>

### Diagnosis Procedure

INFOID:000000004363657

#### 1. REPLACE DRIVER SEAT CONTROL UNIT

When DTC [U1010] is detected, replace driver seat control unit.

>> Replace driver seat control unit. Refer to [ADP-193. "Removal and Installation"](#).

# B2130 EEPROM

< COMPONENT DIAGNOSIS >

## B2130 EEPROM

### DTC Logic

INFOID:000000004363658

### DTC DETECTION LOGIC

DTC No.	Trouble diagnosis name	DTC detecting condition	Possible cause
B2130	EEPROM	Driver seat control unit detected CPU malfunction.	• Driver seat control unit

### DTC CONFIRMATION PROCEDURE

#### 1. STEP 1

Turn ignition switch ON.

>> GO TO 2

#### 2. STEP 2

Check "Self diagnostic result" with CONSULT-III.

Is the DTC detected?

YES >> Perform diagnosis procedure. Refer to [ADP-39, "Diagnosis Procedure"](#).

NO >> Inspection End.

### Diagnosis Procedure

INFOID:000000004363659

#### 1. PERFORM DTC CONFIRMATION PROCEDURE

1. Turn ignition switch ON.
2. Check "Self diagnostic result" with CONSULT-III.
3. Erase the DTC.
4. Perform DTC confirmation procedure. Refer to [ADP-39, "DTC Logic"](#).

Is the DTC displayed again?

YES >> GO TO 2

NO >> Check intermittent incident. Refer to [GI-39, "Intermittent Incident"](#).

#### 2. REPLACE DRIVER SEAT CONTROL UNIT

Replace driver seat control unit. Refer to [ADP-193, "Removal and Installation"](#).

>> Inspection End.

A  
B  
C  
D  
E  
F  
G  
H  
I  
K  
L  
M  
N  
O  
P

ADP

# B2112 SLIDING MOTOR

< COMPONENT DIAGNOSIS >

## B2112 SLIDING MOTOR

### Description

INFOID:000000003900266

- The seat sliding motor is installed to the seat frame.
- The seat sliding motor is installed with the driver seat control unit.
- Slides the seat frontward/rearward by changing the rotation direction of sliding motor.

### DTC Logic

INFOID:000000003900267

### DTC DETECTION LOGIC

DTC No.	Trouble diagnosis name	DTC detecting condition	Possible cause
B2112	SEAT SLIDE	The driver seat control unit detects the output of sliding motor output terminal for 0.1 second or more even if the sliding switch is not input.	<ul style="list-style-type: none"><li>• Driver seat control unit</li><li>• Front power seat LH (sliding motor) harness is shorted</li></ul>

### DTC CONFIRMATION PROCEDURE

#### 1. STEP 1

Turn ignition switch ON.

>> GO TO 2

#### 2. STEP 2

Check "Self diagnostic result" with CONSULT-III.

Is the DTC detected?

- YES >> Perform diagnosis procedure. Refer to [ADP-40, "Diagnosis Procedure"](#).  
NO >> Inspection End.

### Diagnosis Procedure

INFOID:000000003900268

#### 1. PERFORM DTC CONFIRMATION PROCEDURE

1. Turn ignition switch ON.
2. Check "Self diagnostic result" with CONSULT-III.
3. Erase the DTC.
4. Perform DTC confirmation procedure. Refer to [ADP-40, "DTC Logic"](#).

Is the DTC displayed again?

- YES >> GO TO 2  
NO >> Check intermittent incident. Refer to [GI-39, "Intermittent Incident"](#).

#### 2. CHECK COMPONENTS

Refer to [ADP-72, "Component Function Check"](#) and [ADP-95, "Component Function Check"](#).

>> Inspection End.



# B2113 RECLINING MOTOR

< COMPONENT DIAGNOSIS >

## B2113 RECLINING MOTOR

### Description

INFOID:000000003900269

- The seat reclining motor is installed to the seatback assembly.
- The seat reclining motor is activated with the driver seat control unit.
- Tilts the seatback frontward/rearward by changing the rotation direction of reclining motor.

### DTC Logic

INFOID:000000003900270

### DTC DETECTION LOGIC

DTC No.	Trouble diagnosis name	DTC detecting condition	Possible cause
B2113	SEAT RECLINING	The driver seat control unit detects the output of reclining motor output terminal for 0.1 second or more even if the reclining switch is not input.	<ul style="list-style-type: none"><li>• Driver seat control unit</li><li>• Front power seat LH (reclining motor) harness is shorted</li></ul>

### DTC CONFIRMATION PROCEDURE

#### 1. STEP 1

Turn ignition switch ON.

>> GO TO 2

#### 2. STEP 2

Check "Self diagnostic result" with CONSULT-III.

Is the DTC detected?

- YES >> Perform diagnosis procedure. Refer to [ADP-41, "Diagnosis Procedure"](#).  
NO >> Inspection End.

### Diagnosis Procedure

INFOID:000000003900271

ADP

#### 1. PERFORM DTC CONFIRMATION PROCEDURE

1. Turn ignition switch ON.
2. Check "Self diagnostic result" with CONSULT-III.
3. Erase the DTC.
4. Perform DTC confirmation procedure. Refer to [ADP-41, "DTC Logic"](#).

Is the DTC displayed again?

- YES >> GO TO 2  
NO >> Check intermittent incident. Refer to [GI-39, "Intermittent Incident"](#).

#### 2. CHECK COMPONENTS

Refer to [ADP-75, "Component Function Check"](#) and [ADP-97, "Component Function Check"](#).

>> Inspection End.

# B2116 TILT MOTOR

< COMPONENT DIAGNOSIS >

## B2116 TILT MOTOR

### Description

INFOID:000000004363660

- The tilt motor is installed to the steering column assembly.
- The tilt motor is activated with the automatic drive positioner control unit.
- The steering column is tilted up/down by changing the rotation direction tilt motor.

### DTC Logic

INFOID:000000004363661

### DTC DETECTION LOGIC

DTC No.	Trouble diagnosis name	DTC detecting condition	Possible cause
B2116	STEERING TILT	The automatic drive positioner control unit detects the output of reclining motor output terminal for 0.1 second or more even if the tilt switch is not input.	<ul style="list-style-type: none"><li>• Automatic drive positioner control unit</li><li>• Tilt motor harness is shorted</li></ul>

### DTC CONFIRMATION PROCEDURE

#### 1. STEP 1

Turn ignition switch ON.

>> GO TO 2

#### 2. STEP 2

Check "Self diagnostic result" with CONSULT-III.

Is the DTC detected?

YES >> Perform diagnosis procedure. Refer to [ADP-42, "Diagnosis Procedure"](#).

NO >> Inspection End.

### Diagnosis Procedure

INFOID:000000004363662

#### 1. PERFORM DTC CONFIRMATION PROCEDURE

1. Turn ignition switch ON.
2. Check "Self diagnostic result" with CONSULT-III.
3. Erase the DTC.
4. Perform DTC confirmation procedure. Refer to [ADP-42, "DTC Logic"](#).

Is the DTC displayed again?

YES >> GO TO 2

NO >> Check intermittent incident. Refer to [GI-39, "Intermittent Incident"](#).

#### 2. CHECK COMPONENTS

Refer to [ADP-103, "Component Function Check"](#).

>> Inspection End.

# B2128 UART COMMUNICATION LINE

< COMPONENT DIAGNOSIS >

## B2128 UART COMMUNICATION LINE

### Description

INFOID:000000003900287

Driver seat control unit performs UART communication with the automatic drive positioner control unit using 1 communication line. Driver seat control unit receives the operation signals of ADP steering switch, door mirror remote control switch and the position signals of tilt sensor, telescopic sensor and door mirror sensors from the automatic drive positioner control unit and transmits the operation request signal.

### DTC Logic

INFOID:000000003900288

### DTC DETECTION LOGIC

DTC No.	Trouble diagnosis name	DTC detecting condition	Possible cause
B2128	UART COMM	The communication between driver seat control unit and automatic drive positioner control unit is interrupted for a period of time.	<ul style="list-style-type: none"> <li>• UART communication line (UART communication line is open or shorted)</li> <li>• Driver seat control unit</li> <li>• Automatic drive positioner control unit</li> </ul>

### DTC CONFIRMATION PROCEDURE

#### 1. STEP 1

Turn ignition switch ON.

>> GO TO 2

#### 2. PROCEDURE

Check "Self diagnostic result" with CONSULT-III.

Is the DTC detected?

- YES >> Perform diagnosis procedure. Refer to [ADP-43, "Diagnosis Procedure"](#).  
 NO >> Inspection End.

### Diagnosis Procedure

INFOID:000000003900289

#### 1. PERFORM DTC CONFIRMATION PROCEDURE

1. Turn ignition switch ON.
2. Check "Self diagnostic result" with CONSULT-III.
3. Erase the DTC.
4. Perform DTC confirmation procedure. Refer to [ADP-43, "DTC Logic"](#).

Is the DTC displayed again?

- YES >> GO TO 2.  
 NO >> Check intermittent incident. Refer to [GI-39, "Intermittent Incident"](#).

#### 2. CHECK UART COMMUNICATION LINE CONTINUITY

1. Turn ignition switch OFF.
2. Disconnect driver seat control unit and automatic drive positioner control unit.
3. Check continuity between driver seat control unit harness connector and automatic drive positioner control unit harness connector.

Driver seat control unit connector	Terminal	Automatic drive positioner control unit connector	Terminal	Continuity
B203(A)	2	M63 (B)	8	Yes

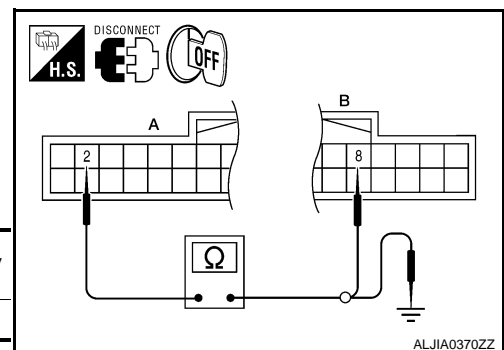

4. Check continuity between driver seat control unit harness connector and ground.

## B2128 UART COMMUNICATION LINE

### < COMPONENT DIAGNOSIS >

---

Driver seat control unit connector	Terminal	Ground	Continuity
B203 (A)	2		No

#### Is the inspection result normal?

- YES >> Check intermittent incident. Refer to [GI-39, "Intermittent Incident"](#).  
NO >> Repair or replace harness.

# POWER SUPPLY AND GROUND CIRCUIT

< COMPONENT DIAGNOSIS >

## POWER SUPPLY AND GROUND CIRCUIT

### BCM

#### BCM : Diagnosis Procedure

INFOID:000000004363685

### 1. CHECK FUSE AND FUSIBLE LINK

Check if the following BCM fuses or fusible link are blown.

Terminal No.	Signal name	Fuse and fusible link No.
1	Battery power supply	H
11		10
24		7

Is the fuse or fusible link blown?

YES >> Replace the blown fuse or fusible link after repairing the affected circuit.

NO >> GO TO 2

### 2. CHECK POWER SUPPLY CIRCUIT

1. Turn ignition switch OFF.
2. Disconnect BCM.
3. Check voltage between BCM harness connector and ground.

Terminals		Voltage (Approx.)
(+)	(-)	
BCM		Ground Battery voltage
Connector	Terminal	
M16 (A)	1	
M17 (B)	11	
M18 (C)	24	

Is the measurement normal?

YES >> GO TO 3

NO >> Repair or replace harness.

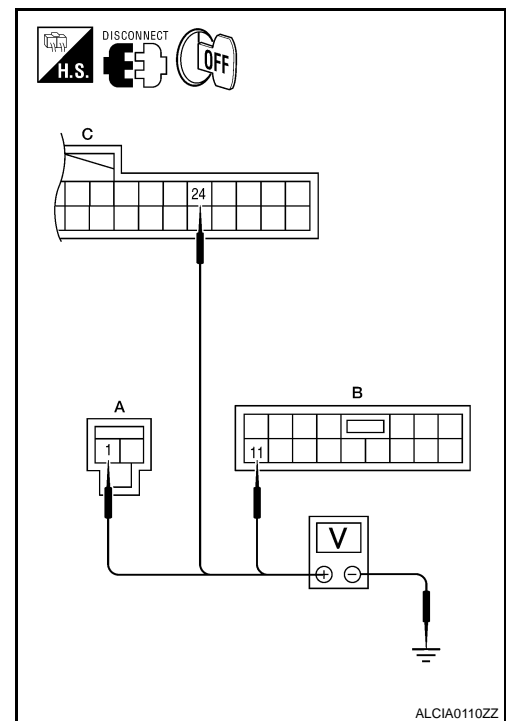

### 3. CHECK GROUND CIRCUIT

Check continuity between BCM harness connector and ground.

BCM		Ground	Continuity
Connector	Terminal		
M17	13		Yes

Does continuity exist?

YES >> Inspection End.

NO >> Repair or replace harness.

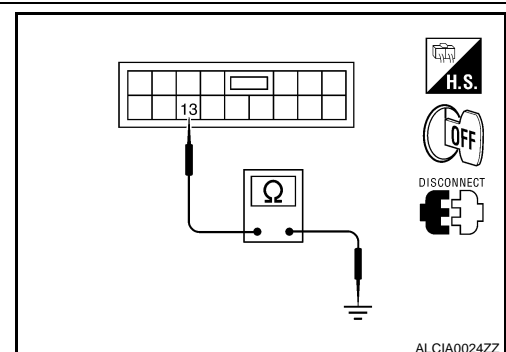

## DRIVER SEAT CONTROL UNIT

# POWER SUPPLY AND GROUND CIRCUIT

< COMPONENT DIAGNOSIS >

## DRIVER SEAT CONTROL UNIT : Diagnosis Procedure

INFOID:000000003900292

### NOTE:

Do not disconnect the battery negative terminal and the driver seat control unit connector until DTC is confirmed with CONSULT-III.

### 1. CHECK POWER SUPPLY CIRCUIT

1. Turn ignition switch OFF.
2. Disconnect driver seat control unit.
3. Check voltage between driver seat control unit harness connector and ground.

Terminals		Power source	Condition	Voltage (V) (Approx.)
(+)	(-)			
Driver seat control unit connector	Terminal			
B211	33	Battery power supply	Ignition switch OFF	Battery voltage

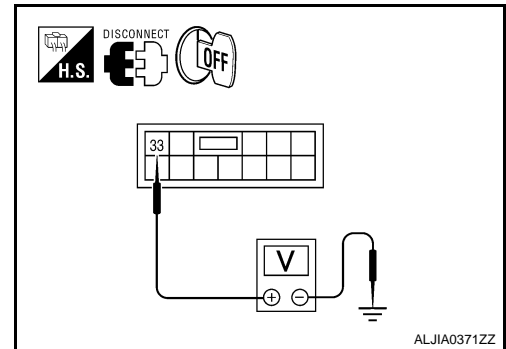

Is the inspection result normal?

- YES >> GO TO 2  
 NO >> Check the following.
- Repair or replace harness.
  - Circuit breaker.

### 2. CHECK GROUND CIRCUIT

Check continuity between the driver seat control unit harness connector and ground.

Driver seat control unit connector	Terminal	Ground	Continuity
B211	43		Yes

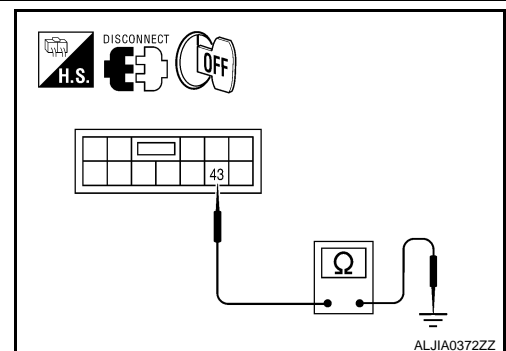

Is the inspection result normal?

- YES >> Driver seat control unit power supply and ground circuit are OK.  
 NO >> Repair or replace harness.

## DRIVER SEAT CONTROL UNIT : Special Repair Requirement

INFOID:000000003900293

### 1. PERFORM ADDITIONAL SERVICE

Perform additional service when removing battery negative terminal.

>> Refer to Owner's Manual.

## AUTOMATIC DRIVE POSITIONER CONTROL UNIT

### AUTOMATIC DRIVE POSITIONER CONTROL UNIT : Diagnosis Procedure

INFOID:000000003900294

### NOTE:

Do not disconnect the battery negative terminal and the driver seat control unit connector until DTC is confirmed with CONSULT-III.

### 1. CHECK POWER SUPPLY CIRCUIT

# POWER SUPPLY AND GROUND CIRCUIT

## < COMPONENT DIAGNOSIS >

1. Turn ignition switch OFF.
2. Disconnect automatic drive positioner control unit.
3. Check voltage between automatic drive positioner control unit harness connector and ground.

Terminals		(-)	Voltage (V) (Approx.)
(+)			
Automatic drive positioner control unit connector	Terminal		
M67	25	Ground	Battery voltage

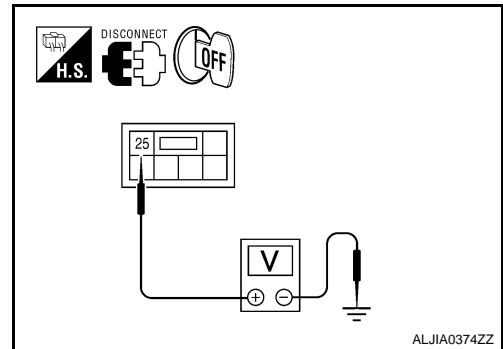

Is the inspection result normal?

- YES >> GO TO 2  
 NO >> Repair or replace harness.

## 2. CHECK GROUND CIRCUIT

Check continuity between the automatic drive positioner control unit harness connector and ground.

Automatic drive positioner control unit connector	Terminal	Ground	Continuity
M67	30		Yes

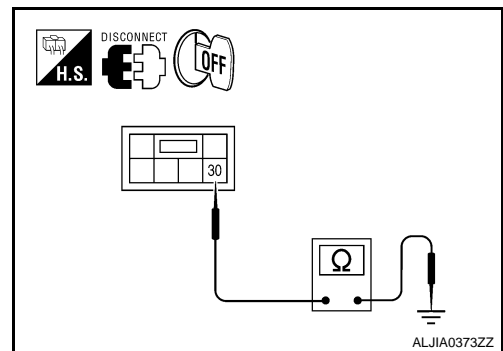

Is the inspection result normal?

- YES >> Automatic drive positioner control unit power supply and ground circuit are OK.  
 NO >> Repair or replace harness.

## AUTOMATIC DRIVE POSITIONER CONTROL UNIT : Special Repair Requirement

INFOID:000000003900295

## 1. PERFORM ADDITIONAL SERVICE

Perform additional service when removing battery negative terminal.

>> Refer to Owner's Manual.

A  
B  
C  
D  
E  
F  
G  
H  
I  
K  
L  
M  
N  
O  
P

ADP

# SLIDING SWITCH

< COMPONENT DIAGNOSIS >

## SLIDING SWITCH

### Description

INFOID:000000003900296

Sliding switch is equipped to the power seat switch LH on the seat frame. The operation signal is input to the driver seat control unit when the sliding switch is operated.

### Component Function Check

INFOID:000000003900297

#### 1. CHECK FUNCTION

1. Select "SLIDE SW-FR", "SLIDE SW-RR" in "Data monitor" mode with CONSULT-III.
2. Check sliding switch signal under the following conditions.

Monitor item	Condition	Status
SLIDE SW-FR	Sliding switch (forward)	Operate ON
		Release OFF
SLIDE SW-RR	Sliding switch (backward)	Operate ON
		Release OFF

Is the indication normal?

YES >> Inspection End.

NO >> Perform diagnosis procedure. Refer to [ADP-48, "Diagnosis Procedure"](#).

### Diagnosis Procedure

INFOID:000000003900298

#### 1. CHECK SLIDING SWITCH SIGNAL

1. Turn ignition switch OFF.
2. Check voltage between driver seat control unit harness connector and ground.

Driver seat control unit connector	Terminals		Condition	Voltage (V) (Approx.)
	(+)	(-)		
B203	8	Ground	Operate (backward)	0
			Release	Battery voltage
	24		Operate (forward)	0
			Release	Battery voltage

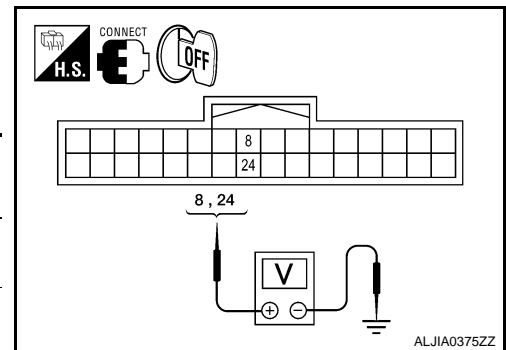

Is the inspection result normal?

YES >> GO TO 5

NO >> GO TO 2

#### 2. CHECK SLIDING SWITCH CIRCUIT

1. Turn ignition switch OFF.
2. Disconnect driver seat control unit and power seat switch LH.
3. Check continuity between driver seat control unit harness connector and power seat switch LH harness connector.

Driver seat control unit connector	Terminal	Power seat switch LH connector	Terminal	Continuity
B203 (A)	8	B213 (B)	6	Yes
	24		7	

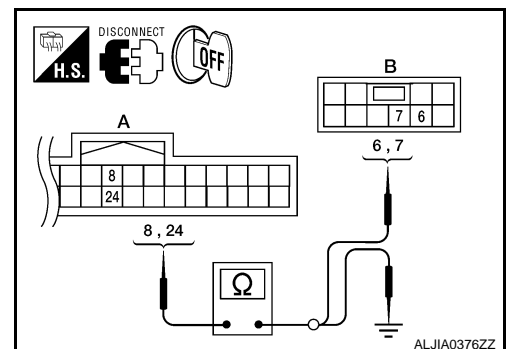



# SLIDING SWITCH

## < COMPONENT DIAGNOSIS >

- Check continuity between driver seat control unit harness connector and ground.

Driver seat control unit connector	Terminal	Ground	Continuity
B203 (A)	8		
	24		

Is the inspection result normal?

- YES >> GO TO 3  
 NO >> Repair or replace harness.

### 3. CHECK DRIVER SEAT CONTROL UNIT OUTPUT

- Connect the driver seat control unit.
- Turn ignition switch ON.
- Check voltage between driver seat control unit harness connector and ground.

Driver seat control unit connector	Terminals		Voltage (V) (Approx.)
	(+)	(-)	
B203	8	Ground	Battery voltage
	24		

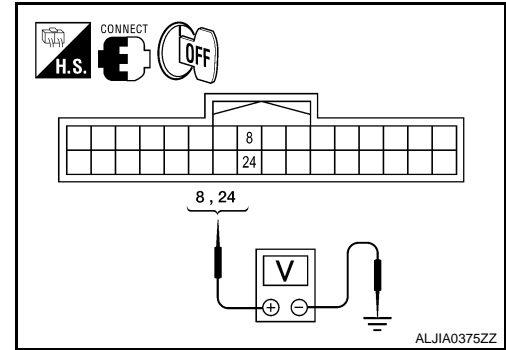

Is the inspection result normal?

- YES >> GO TO 4  
 NO >> Replace driver seat control unit. Refer to [ADP-193, "Removal and Installation"](#).

### 4. CHECK SLIDING SWITCH

Refer to [ADP-49, "Component Inspection"](#).

Is the inspection result normal?

- YES >> GO TO 5  
 NO >> Replace power seat switch LH. Refer to [SE-70, "DRIVER SIDE : Disassembly and Assembly"](#).

### 5. CHECK INTERMITTENT INCIDENT

Refer to [GI-39, "Intermittent Incident"](#).

Is the inspection result normal?

- YES >> Replace driver seat control unit. Refer to [ADP-193, "Removal and Installation"](#).  
 NO >> Repair or replace malfunctioning part.

## Component Inspection

INFOID:000000003900299

### 1. CHECK SLIDING SWITCH

- Turn ignition switch OFF.
- Disconnect power seat switch LH.
- Check continuity between power seat switch LH terminals.

Terminal	Condition		Continuity
4	6	Sliding switch (backward)	Operate: Yes Release: No
		7	Sliding switch (forward)

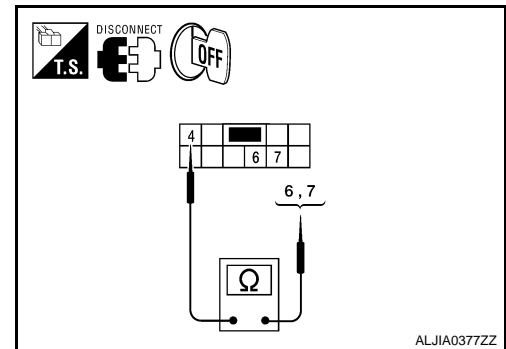

Is the inspection result normal?

- YES >> Inspection End.  
 NO >> Replace power seat switch LH. Refer to [SE-70, "DRIVER SIDE : Disassembly and Assembly"](#).

# RECLINING SWITCH

< COMPONENT DIAGNOSIS >

## RECLINING SWITCH

### Description

INFOID:000000003900300

Reclining switch is equipped to the power seat switch LH on the seat frame. The operation signal is input to the driver seat control unit when the reclining switch is operated.

### Component Function Check

INFOID:000000003900301

#### 1. CHECK FUNCTION

1. Select "RECLN SW-FR", "RECLN SW-RR" in "Data monitor" mode with CONSULT-III.
2. Check reclining switch signal under the following conditions.

Monitor item	Condition	Status	
RECLN SW-FR	Reclining switch (forward)	Operate	ON
		Release	OFF
RECLN SW-RR	Reclining switch (backward)	Operate	ON
		Release	OFF

Is the indication normal?

YES >> Inspection End.

NO >> Perform diagnosis procedure. Refer to [ADP-50, "Diagnosis Procedure"](#).

### Diagnosis Procedure

INFOID:000000003900302

#### 1. CHECK RECLINING SWITCH SIGNAL

1. Turn ignition switch OFF.
2. Check voltage between driver seat control unit harness connector and ground.

Driver seat control unit connector	Terminals		Condition	Voltage (V) (Approx.)
	(+)	(-)		
B203	25	Ground	Operate (forward)	0
			Release	Battery voltage
	9		Operate (backward)	0
			Release	Battery voltage

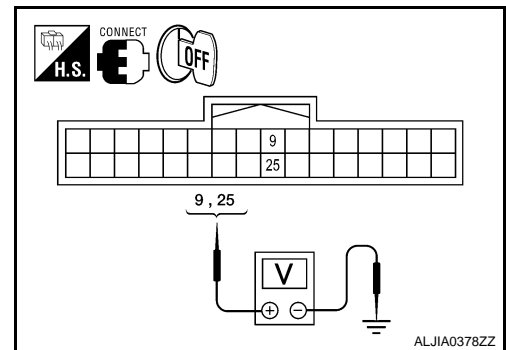

Is the inspection result normal?

YES >> GO TO 5

NO >> GO TO 2

#### 2. CHECK RECLINING SWITCH CIRCUIT

1. Turn ignition switch OFF.
2. Disconnect driver seat control unit and power seat switch LH.
3. Check continuity between driver seat control unit harness connector and power seat switch LH harness connector.

Driver seat control unit connector	Terminal	Power seat switch LH connector	Terminal	Continuity
B203 (A)	25	B213 (B)	5	Yes
	9		10	

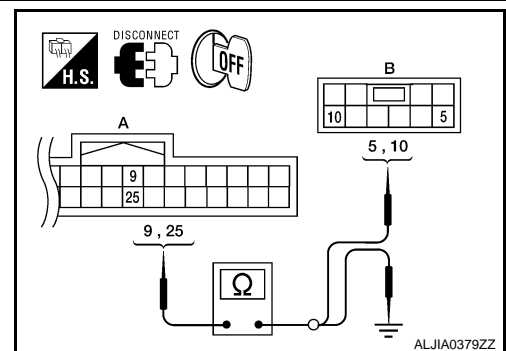

4. Check continuity between driver seat control unit harness connector and ground.

# RECLINING SWITCH

## < COMPONENT DIAGNOSIS >

Driver seat control unit connector	Terminal	Ground	Continuity
B203 (A)	25		Ground
	9		

Is the inspection result normal?

YES >> GO TO 3

NO >> Repair or replace harness.

### 3. CHECK DRIVER SEAT CONTROL UNIT OUTPUT

1. Connect the driver seat control unit connector.
2. Turn ignition switch ON.
3. Check voltage between driver seat control unit harness connector and ground.

Driver seat control unit connector	Terminals		Voltage (V) (Approx.)
	(+)	(-)	
B203	9	Ground	Battery voltage
	25		

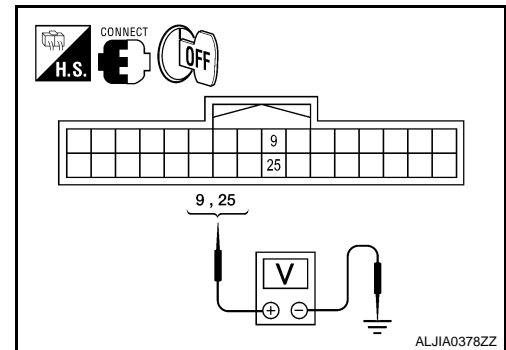

Is the inspection result normal?

YES >> GO TO 4

NO >> Replace driver seat control unit. Refer to [ADP-193, "Removal and Installation"](#).

### 4. CHECK RECLINING SWITCH

Refer to [ADP-51, "Component Inspection"](#).

Is the inspection result normal?

YES >> GO TO 5

NO >> Replace power seat switch LH. Refer to [SE-70, "DRIVER SIDE : Disassembly and Assembly"](#).

### 5. CHECK INTERMITTENT INCIDENT

Refer to [GI-39, "Intermittent Incident"](#).

Is the inspection result normal?

YES >> Replace driver seat control unit. Refer to [ADP-193, "Removal and Installation"](#).

NO >> Repair or replace the malfunctioning part.

## Component Inspection

INFOID:000000003900303

### 1. CHECK RECLINING SWITCH

1. Turn ignition switch OFF.
2. Disconnect power seat switch LH.
3. Check continuity between power seat switch LH terminals.

Terminals		Condition		Continuity
Power seat switch LH				
4	10	Reclining switch (backward)	Operate	Yes
			Release	No
	5	Reclining switch (forward)	Operate	Yes
			Release	No

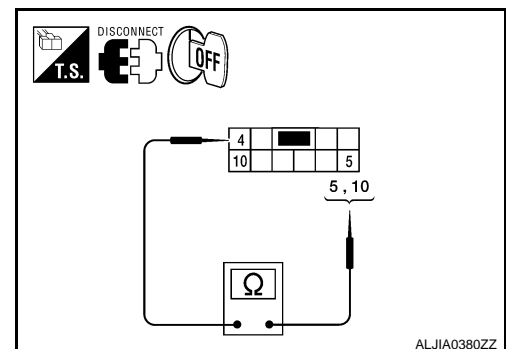

Is the inspection result normal?

YES >> Inspection End.

NO >> Replace power seat switch LH. Refer to [SE-70, "DRIVER SIDE : Disassembly and Assembly"](#).

# LIFTING SWITCH (FRONT)

< COMPONENT DIAGNOSIS >

## LIFTING SWITCH (FRONT)

### Description

INFOID:000000003900304

Lifting switch (front) is equipped to the power seat switch LH on the seat frame. The operation signal is input to the driver seat control unit when the lifting switch (front) is operated.

### Component Function Check

INFOID:000000003900305

#### 1. CHECK FUNCTION

1. Select "LIFT FR SW-UP", "LIFT FR SW-DN" in "DATA MONITOR" mode with CONSULT-III.
2. Check lifting switch (front) signal under the following conditions.

Monitor item	Condition	Status
LIFT FR SW-UP	Lifting switch front (up) Operate	ON
	Release	OFF
LIFT FR SW-DN	Lifting switch front (down) Operate	ON
	Release	OFF

Is the indication normal?

YES >> Inspection End.

NO >> Perform diagnosis procedure. Refer to [ADP-52, "Diagnosis Procedure"](#).

### Diagnosis Procedure

INFOID:000000003900306

#### 1. CHECK LIFTING SWITCH SIGNAL

1. Turn ignition switch OFF.
2. Check voltage between driver seat control unit harness connector and ground.

Driver seat control unit connector	Terminals		Condition	Voltage (V) (Approx.)
	(+)	(-)		
B203	10	Ground	Operate (down)	0V
			Release	Battery voltage
	26		Operate (up)	0V
			Release	Battery voltage

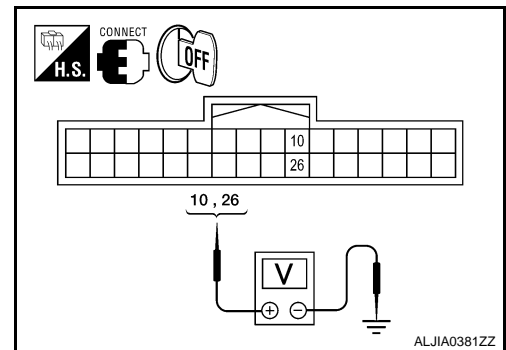

Is the inspection result normal?

YES >> GO TO 5

NO >> GO TO 2

#### 2. CHECK LIFTING SWITCH (FRONT) CIRCUIT

1. Turn ignition switch OFF.
2. Disconnect driver seat control unit and power seat switch LH.
3. Check continuity between driver seat control unit harness connector and power seat switch LH harness connector.

Driver seat control unit connector	Terminal	Power seat switch LH connector	Terminal	Continuity
B203 (A)	10	B213 (B)	1	Yes
	26		2	

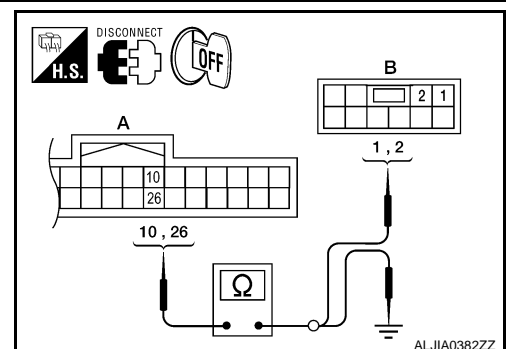

# LIFTING SWITCH (FRONT)

## < COMPONENT DIAGNOSIS >

- Check continuity between driver seat control unit harness connector and ground.

Driver seat control unit connector	Terminal	Ground	Continuity
B203 (A)	10		
	26		

Is the inspection result normal?

- YES >> GO TO 3  
 NO >> Repair or replace harness.

### 3. CHECK DRIVER SEAT CONTROL UNIT OUTPUT

- Connect the driver seat control unit.
- Turn ignition switch ON.
- Check voltage between driver seat control unit harness connector and ground.

Driver seat control unit connector	Terminals		Voltage (V) (Approx.)
	(+)	(-)	
B203 (A)	10	Ground	Battery voltage
	26		

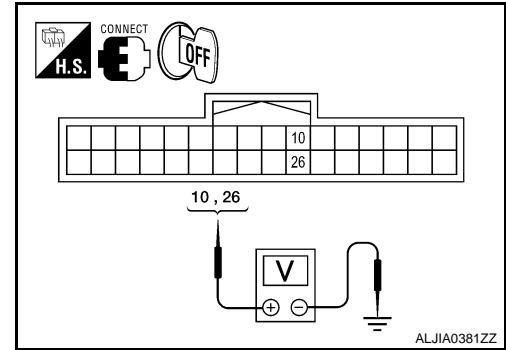

Is the inspection result normal?

- YES >> GO TO 4  
 NO >> Replace driver seat control unit. Refer to [ADP-193, "Removal and Installation"](#).

### 4. CHECK LIFTING SWITCH (FRONT)

Refer to [ADP-53, "Component Inspection"](#).

Is the inspection result normal?

- YES >> GO TO 5  
 NO >> Replace power seat switch LH. Refer to [SE-70, "DRIVER SIDE : Disassembly and Assembly"](#).

### 5. CHECK INTERMITTENT INCIDENT

Refer to [GI-39, "Intermittent Incident"](#).

Is the inspection result normal?

- YES >> Replace driver seat control unit. Refer to [ADP-193, "Removal and Installation"](#).  
 NO >> Repair or replace the malfunctioning part.

## Component Inspection

INFOID:000000003900307

### 1. CHECK LIFTING SWITCH (FRONT)

- Turn ignition switch OFF.
- Disconnect power seat switch LH.
- Check continuity between power seat switch LH terminals.

Terminal		Condition	Continuity
Power seat switch LH			
4	1	Lifting switch front (down)	Operate: Yes Release: No
		2	Lifting switch front (up)

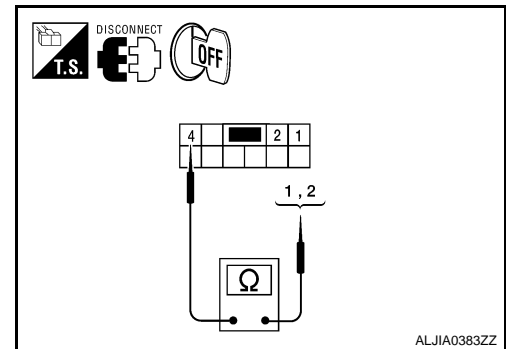

Is the inspection result normal?

- YES >> Inspection End.  
 NO >> Replace power seat switch LH. Refer to [SE-70, "DRIVER SIDE : Disassembly and Assembly"](#).

# LIFTING SWITCH (REAR)

< COMPONENT DIAGNOSIS >

## LIFTING SWITCH (REAR)

### Description

INFOID:000000003900308

Lifting switch (rear) is equipped to the power seat switch LH on the seat frame. The operation signal is inputted to the driver seat control unit when the lifting switch (rear) is operated.

### Component Function Check

INFOID:000000003900309

#### 1. CHECK FUNCTION

1. Select "LIFT RR SW-UP", "LIFT RR SW-DN" in "Data monitor" mode with CONSULT-III.
2. Check lifting switch (rear) signal under the following conditions.

Monitor item	Condition		Status
LIFT RR SW-UP	Lifting switch rear (up)	Operate	ON
		Release	OFF
LIFT RR SW-DN	Lifting switch rear (down)	Operate	ON
		Release	OFF

Is the indication normal?

YES >> Inspection End.

NO >> Perform diagnosis procedure. Refer to [ADP-54, "Diagnosis Procedure"](#).

### Diagnosis Procedure

INFOID:000000003900310

#### 1. CHECK LIFTING SWITCH (REAR) SIGNAL

1. Turn ignition switch OFF.
2. Check voltage between driver seat control unit harness connector and ground.

Driver seat control unit connector	Terminals		Condition	Voltage (V) (Approx.)
	(+)	(-)		
B203	11	Ground	Operate (down)	0
			Release	Battery voltage
	27		Operate (up)	0
			Release	Battery voltage

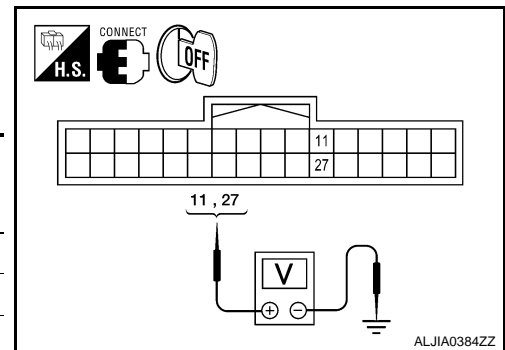

Is the inspection result normal?

YES >> GO TO 5

NO >> GO TO 2

#### 2. CHECK LIFTING SWITCH (REAR) CIRCUIT

1. Turn ignition switch OFF.
2. Disconnect driver seat control unit and power seat switch LH.
3. Check continuity between driver seat control unit harness connector and power seat switch LH harness connector.

Driver seat control unit connector	Terminal	Power seat switch LH connector	Terminal	Continuity
B203 (A)	11	B213 (B)	8	Yes
	27		9	

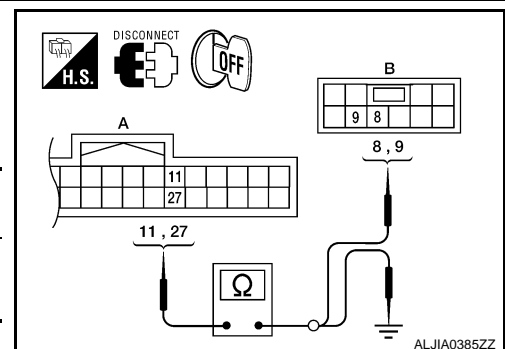

4. Check continuity between driver seat control unit harness connector and ground.

# LIFTING SWITCH (REAR)

## < COMPONENT DIAGNOSIS >

Driver seat control unit connector	Terminal	Ground	Continuity
B203 (A)	11		Ground
	27		

Is the inspection result normal?

YES >> GO TO 3

NO >> Repair or replace harness.

### 3. CHECK DRIVER SEAT CONTROL UNIT OUTPUT

1. Connect the driver seat control unit.
2. Turn ignition switch ON.
3. Check voltage between driver seat control unit harness connector and ground.

Driver seat control unit connector	Terminals		Voltage (V) (Approx.)
	(+)	(-)	
B203	11	Ground	Battery voltage
	27		

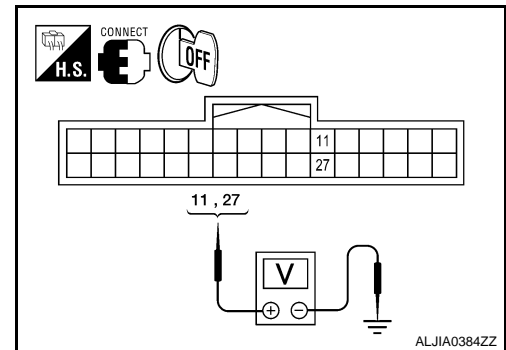

Is the inspection result normal?

YES >> GO TO 4

NO >> Replace driver seat control unit. Refer to [ADP-193, "Removal and Installation"](#).

### 4. CHECK LIFTING SWITCH (REAR)

Refer to [ADP-55, "Component Inspection"](#).

Is the inspection result normal?

YES >> GO TO 5

NO >> Replace power seat switch LH. Refer to [SE-70, "DRIVER SIDE : Disassembly and Assembly"](#).

### 5. CHECK INTERMITTENT INCIDENT

Refer to [GI-39, "Intermittent Incident"](#).

Is the inspection result normal?

YES >> Replace driver seat control unit. Refer to [ADP-193, "Removal and Installation"](#).

NO >> Repair or replace the malfunctioning part.

## Component Inspection

INFOID:000000003900311

### 1. CHECK LIFTING SWITCH (REAR)

1. Turn ignition switch OFF.
2. Disconnect power seat switch LH.
3. Check continuity between power seat switch LH terminals.

Terminal		Condition	Continuity
Power seat switch LH			
4	9	Lifting switch rear (up)	Operate: Yes
		Release	No
	8	Lifting switch rear (down)	Operate: Yes
		Release	No

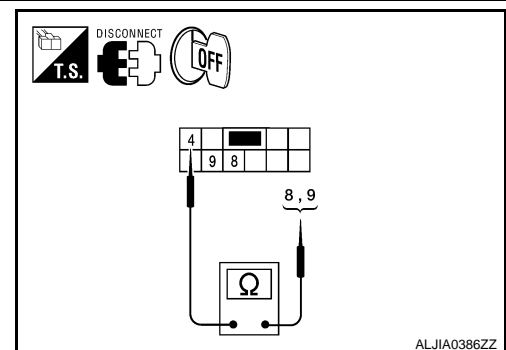

Is the inspection result normal?

YES >> Inspection End.

NO >> Replace power seat switch LH. Refer to [SE-70, "DRIVER SIDE : Disassembly and Assembly"](#).

# TILT SWITCH

< COMPONENT DIAGNOSIS >

## TILT SWITCH

### Description

INFOID:000000004363674

ADP steering switch (tilt switch) is equipped to the steering column. The operation signal is input to the automatic drive positioner control unit when the ADP steering switch is operated.

### Component Function Check

INFOID:000000004363675

#### 1. CHECK FUNCTION

1. Select "TILT SW-UP", "TILT SW-DOWN" in "Data monitor" mode with CONSULT-III.
2. Check tilt switch signal under the following conditions.

Monitor item	Condition		Status
TILT SW-UP	Tilt switch (up)	Operate	ON
		Release	OFF
TILT SW-DN	Tilt switch (down)	Operate	ON
		Release	OFF

Is the indication normal?

YES >> Inspection End.

NO >> Perform diagnosis procedure. Refer to [ADP-56, "Diagnosis Procedure"](#).

### Diagnosis Procedure

INFOID:000000004363676

#### 1. CHECK TILT SWITCH SIGNAL

1. Disconnect ADP steering switch (tilt switch).
2. Check voltage between ADP steering switch harness connector and ground.

(+)		(-)	Voltage (V) (Approx.)
Connector	Terminals		
M39	4	Ground	Battery voltage
	5		

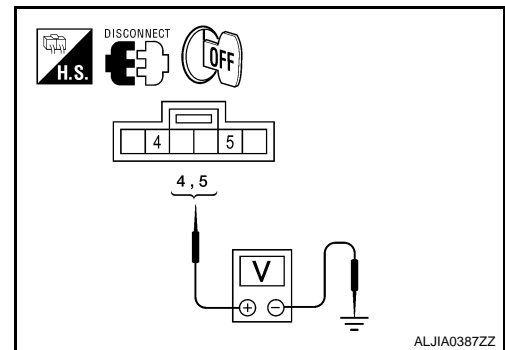

Is the inspection result normal?

YES >> GO TO 3

NO >> GO TO 2

#### 2. CHECK TILT SWITCH CIRCUIT

1. Disconnect automatic drive positioner control unit.
2. Check continuity between automatic drive positioner control unit harness connector and ADP steering switch harness connector.

Automatic drive positioner control unit		ADP steering switch (tilt switch)		Continuity
Connector	Terminal	Connector	Terminal	
M63 (A)	1	M39 (B)	4	Yes
	13		5	

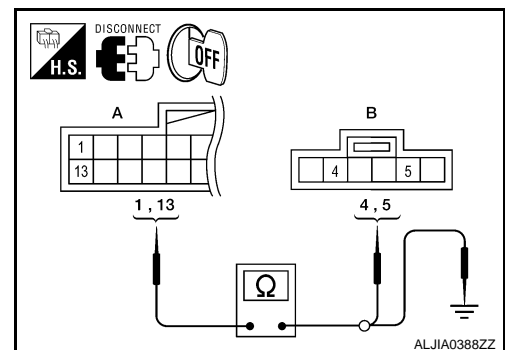

3. Check continuity between automatic drive positioner control unit harness connector and ground.



# TILT SWITCH

## < COMPONENT DIAGNOSIS >

Automatic drive positioner control unit		Ground	Continuity
Connector	Terminal		
M63 (A)	1		No
	13		

Is the inspection result normal?

- YES >> Replace automatic drive positioner unit. Refer to [ADP-194, "Removal and Installation"](#).  
 NO >> Repair or replace harness.

### 3. CHECK TILT SWITCH

Refer to [ADP-57, "Component Inspection"](#).

Is the inspection result normal?

- YES >> GO TO 4  
 NO >> Replace ADP steering switch (tilt switch). Refer to [ADP-196, "Removal and Installation"](#).

### 4. CHECK INTERMITTENT INCIDENT

Refer to [GI-39, "Intermittent Incident"](#).

>> Inspection End.

## Component Inspection

INFOID:000000004363677

### 1. CHECK TILT SWITCH

- Turn ignition switch OFF.
- Disconnect ADP steering switch (tilt switch).
- Check continuity between ADP steering switch terminals.

ADP steering switch (tilt switch)		Condition	Continuity
Terminal			
1	4	Tilt switch (up) Operate	Yes
		Release	No
	5	Tilt switch (down) Operate	Yes
		Release	No

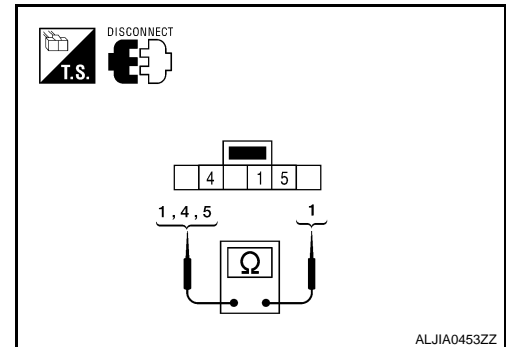

ALJIA0453ZZ

Is the inspection result normal?

- YES >> Inspection End.  
 NO >> Replace ADP steering switch (tilt switch). Refer to [ADP-196, "Removal and Installation"](#).

# TELESCOPIC SWITCH

< COMPONENT DIAGNOSIS >

## TELESCOPIC SWITCH

### Description

INFOID:000000004363663

ADP steering switch (telescopic switch) is equipped to the steering column. The operation signal is input to the automatic drive positioner control unit when the telescopic switch is operated.

### Component Function Check

INFOID:000000004363664

#### 1. CHECK FUNCTION

1. Select "TELESCO SW-FR", "TELESCO SW-RR" in "Data monitor" mode with CONSULT-III.
2. Check telescopic switch signal under the following conditions.

Monitor item	Condition		Status
TELESCO SW-FR	Telescopic switch (forward)	Operate	ON
		Release	OFF
TELESCO SW-RR	Telescopic switch (backward)	Operate	ON
		Release	OFF

Is the indication normal?

YES >> Inspection End.

NO >> Perform diagnosis procedure. Refer to [ADP-58, "Diagnosis Procedure"](#).

### Diagnosis Procedure

INFOID:000000004363665

#### 1. CHECK TELESCOPIC SWITCH SIGNAL

1. Disconnect ADP steering switch (telescopic switch).
2. Check voltage between ADP steering switch harness connector and ground.

(+)		(-)	Voltage (V) (Approx.)
Connector	Terminals		
M39	2	Ground	Battery voltage
	3		

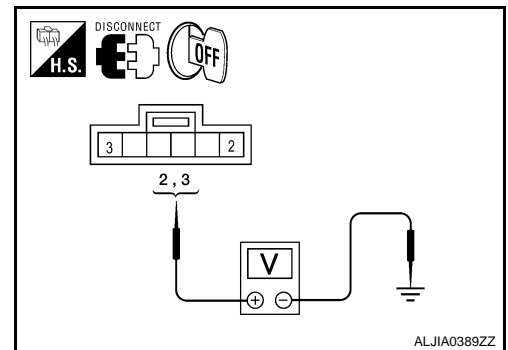

Is the inspection result normal?

YES >> GO TO 3

NO >> GO TO 2

#### 2. CHECK TELESCOPIC SWITCH CIRCUIT

1. Disconnect automatic drive positioner control unit.
2. Check continuity between automatic drive positioner control unit harness connector and ADP steering switch harness connector.

Automatic drive positioner control unit		ADP steering switch (telescopic switch)		Continuity
Connector	Terminal	Connector	Terminal	
M63 (A)	7	M39 (B)	2	Yes
	19		3	

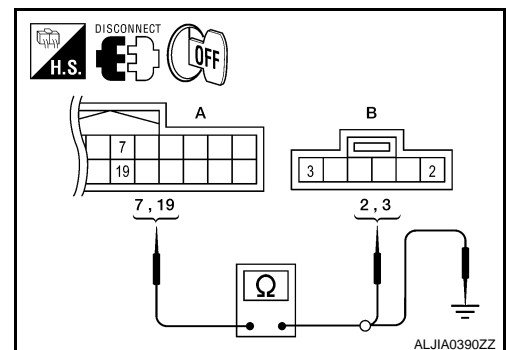

3. Check continuity between automatic drive positioner control unit harness connector and ground.

# TELESCOPIC SWITCH

## < COMPONENT DIAGNOSIS >

Automatic drive positioner control unit		Ground	Continuity
Connector	Terminal		No
M63 (A)	7 19		

Is the inspection result normal?

- YES >> Replace automatic drive positioner unit. Refer to [ADP-194, "Removal and Installation"](#).  
 NO >> Repair or replace harness.

### 3. CHECK TELESCOPIC SWITCH

Refer to [ADP-59, "Component Inspection"](#).

Is the inspection result normal?

- YES >> GO TO 4  
 NO >> Replace ADP steering switch (telescopic switch). Refer to [ADP-196, "Removal and Installation"](#).

### 4. CHECK INTERMITTENT INCIDENT

Refer to [GI-39, "Intermittent Incident"](#).

>> Inspection End.

## Component Inspection

INFOID:000000004363666

### 1. CHECK TELESCOPIC SWITCH

1. Turn ignition switch OFF.
2. Disconnect ADP steering switch (telescopic switch).
3. Check continuity between ADP steering switch terminals.

ADP steering switch (telescopic switch)		Condition	Continuity	
Terminal				
1	2	Telescopic switch (forward)	Operate	Yes
			Release	No
	3	Telescopic switch (backward)	Operate	Yes
			Release	No

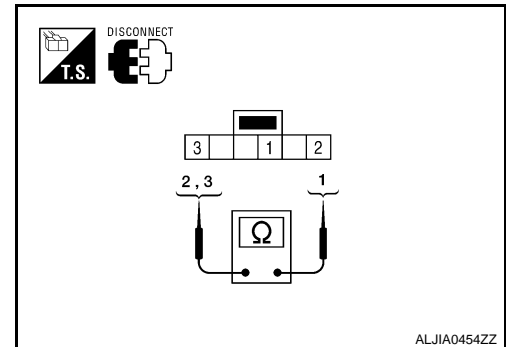

ALJIA0454ZZ

Is the inspection result normal?

- YES >> Inspection End.  
 NO >> Replace ADP steering switch (telescopic switch). Refer to [ADP-196, "Removal and Installation"](#).

# SEAT MEMORY SWITCH

< COMPONENT DIAGNOSIS >

## SEAT MEMORY SWITCH

### Description

INFOID:000000003900316

Memory switch is equipped on the seat memory switch installed to the front door LH trim. The operation signal is input to the driver seat control unit when the memory switch is operated.

### Component Function Check

INFOID:000000003900317

#### 1. CHECK FUNCTION

1. Select "MEMORY SW 1", "MEMORY SW 2", "SET SW" in "Data monitor" mode with CONSULT-III.
2. Check seat memory switch signal under the following conditions.

Monitor item	Condition	Status	
MEMORY SW1	Memory switch 1	Push Release	ON OFF
	MEMORY SW2	Memory switch 2	Push Release
SET SW		Set switch	Push Release

Is the indication normal?

YES >> Inspection End.

NO >> Perform diagnosis procedure. Refer to [ADP-60. "Diagnosis Procedure"](#).

### Diagnosis Procedure

INFOID:000000004364416

#### 1. CHECK SEAT MEMORY SWITCH SIGNAL

1. Disconnect driver seat control unit.
2. Check voltage between driver seat control unit harness connector and ground.

(+)		(-)	Voltage (V) (Approx.)
Connector	Terminals		
B203	6	Ground	5
	22		
	28		

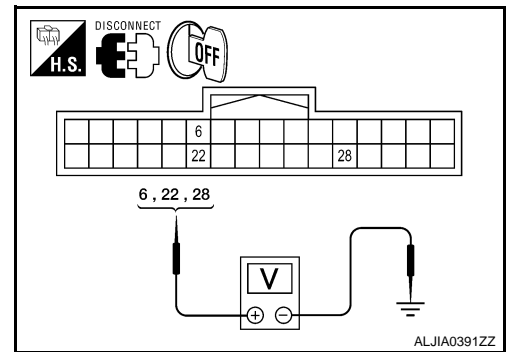

Is the inspection result normal?

YES >> GO TO 3

NO >> GO TO 2

#### 2. CHECK MEMORY SWITCH CIRCUIT

1. Disconnect seat memory switch.
2. Check continuity between driver seat control unit harness connector and seat memory switch harness connector.

Driver seat control unit		Seat memory switch		Continuity
Connector	Terminal	Connector	Terminal	
B203 (A)	6	D13 (B)	2	Yes
	22		1	
	28		3	

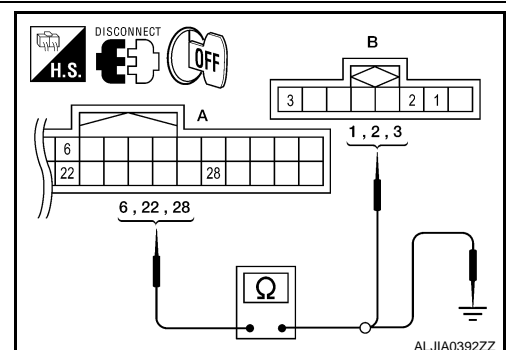

# SEAT MEMORY SWITCH

## < COMPONENT DIAGNOSIS >

3. Check continuity between driver seat control unit harness connector and ground.

Driver seat control unit		Ground	Continuity
Connector	Terminal		
B203 (A)	6	Ground	No
	22		
	28		

Is the inspection result normal?

- YES >> Replace driver seat control unit. Refer to [ADP-193. "Removal and Installation"](#).
- NO >> Repair or replace harness.

### 3. CHECK MEMORY SWITCH GROUND CIRCUIT

Check continuity between seat memory switch harness connector and ground.

Seat memory switch		Ground	Continuity
Connector	Terminal		
D13	4	Ground	Yes

Is the inspection result normal?

- YES >> GO TO 4
- NO >> Repair or replace harness.

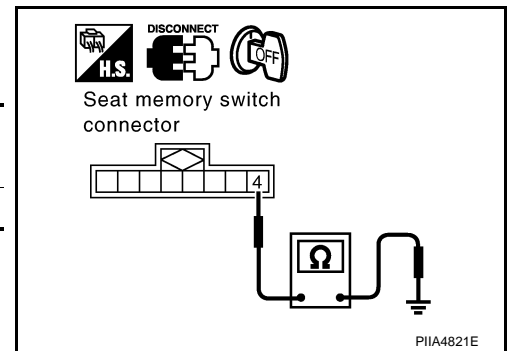

### 4. CHECK SEAT MEMORY SWITCH

Refer to [ADP-61. "Component Inspection"](#).

Is the inspection result normal?

- YES >> GO TO 5.
- NO >> Replace seat memory switch. Refer to [ADP-195. "Removal and Installation"](#).

### 5. CHECK INTERMITTENT INCIDENT

Refer to [GI-39. "Intermittent Incident"](#).

>> Inspection End.

## Component Inspection

INFOID:000000003900319

### 1. CHECK SEAT MEMORY SWITCH

1. Turn ignition switch OFF.
2. Disconnect seat memory switch.
3. Check continuity between seat memory switch terminals.

Terminal		Condition	Continuity	
Seat memory switch				
4	1	Memory switch 1	Push	Yes
			Release	No
	2	Memory switch 2	Push	Yes
			Release	No
	3	Set switch	Push	Yes
			Release	No

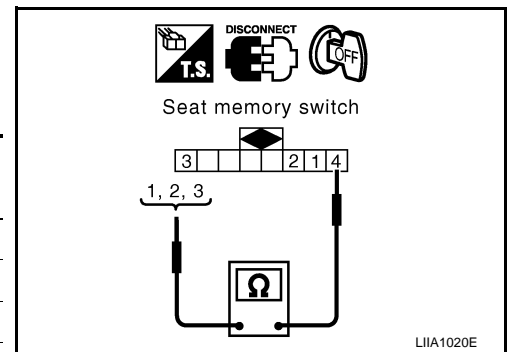

Is the inspection result normal?

- YES >> Inspection End.
- NO >> Replace seat memory switch. Refer to [ADP-195. "Removal and Installation"](#).

# DOOR MIRROR REMOTE CONTROL SWITCH

< COMPONENT DIAGNOSIS >

## DOOR MIRROR REMOTE CONTROL SWITCH CHANGEOVER SWITCH

### CHANGEOVER SWITCH : Description

INFOID:000000003900320

Changeover switch is integrated into door mirror remote control switch.  
Changeover switch has three positions (L, N and R).

It changes door mirror motor operation by transmitting control signal to automatic drive positioner control unit.

### CHANGEOVER SWITCH : Component Function Check

INFOID:000000003900321

#### 1. CHECK FUNCTION

1. Select "MIR CHNG SW-R", "MIR CHNG SW-L" in "Data monitor" mode with CONSULT-III.
2. Check tilt switch signal under the following conditions.

Monitor item	Condition		Status
MIR CHNG SW-R	Mirror switch (right)	Operate	ON
		Release	OFF
MIR CHNG SW-L	Mirror switch (left)	Operate	ON
		Release	OFF

Is the indication normal?

YES >> Inspection End.

NO >> Perform diagnosis procedure. Refer to [ADP-62. "CHANGEOVER SWITCH : Diagnosis Procedure"](#).

### CHANGEOVER SWITCH : Diagnosis Procedure

INFOID:000000003900322

#### 1. CHECK CHANGEOVER SWITCH SIGNAL

1. Turn ignition switch ON.
2. Check voltage between automatic drive positioner control unit connector and ground.

Terminals		(-)	Change over switch condition	Voltage (V) (Approx.)
(+)	Terminal			
Automatic drive positioner control unit connector	2	Ground	RIGHT	0
	14		Other than above	5
M63	2		LEFT	0
	14		Other than above	5

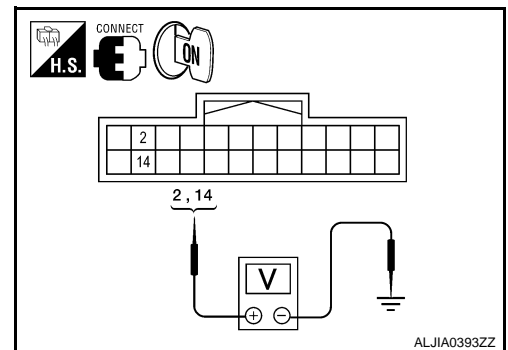

Is the inspection result normal?

YES >> GO TO 6

NO >> GO TO 2

#### 2. CHECK HARNESS CONTINUITY

# DOOR MIRROR REMOTE CONTROL SWITCH

## < COMPONENT DIAGNOSIS >

1. Turn ignition switch OFF.
2. Disconnect automatic drive positioner control unit and door mirror remote control switch.
3. Check continuity between automatic drive positioner control unit connector and door mirror remote control switch connector.

Automatic drive positioner control unit connector	Terminal	Door mirror remote control switch connector	Terminal	Continuity
M63 (A)	2	M108 (B)	3	Yes
	14		2	

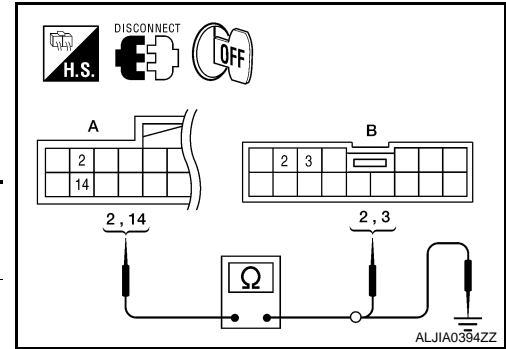

4. Check continuity between automatic drive positioner control unit connector and ground.

Automatic drive positioner control unit connector	Terminal	Ground	Continuity
M63 (A)	2	Ground	No
	14		

Is the inspection result normal?

- YES >> GO TO 3  
 NO >> Repair or replace harness.

### 3. CHECK DOOR MIRROR REMOTE CONTROL SWITCH GROUND CIRCUIT

Check continuity between door mirror remote control switch connector and ground.

Door mirror remote control switch connector	Terminal	Ground	Continuity
M108	13	Ground	Yes

Is the inspection result normal?

- YES >> GO TO 4  
 NO >> Repair or replace harness.

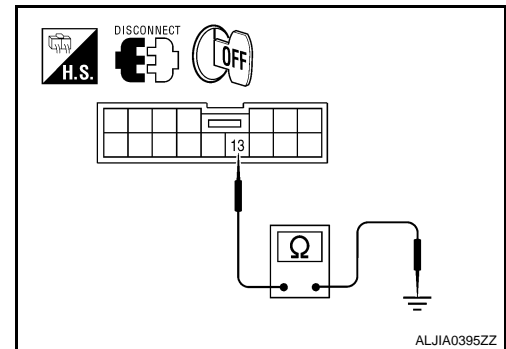

### 4. CHECK AUTOMATIC DRIVE POSITIONER CONTROL UNIT OUTPUT SIGNAL

1. Connect automatic drive positioner control unit.
2. Turn ignition switch ON.
3. Check voltage between automatic drive positioner control unit connector and ground.

Terminals			Voltage (V) (Approx.)
(+)		(-)	
Automatic drive positioner control unit connector	Terminal		
M63	2	Ground	5
	14		

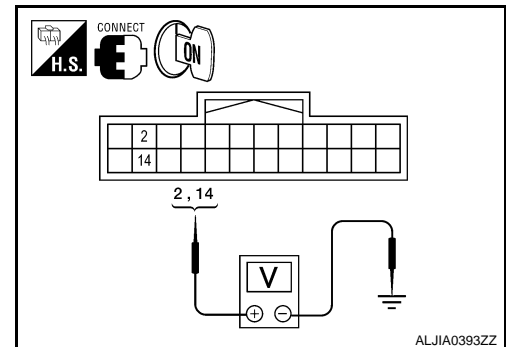

Is the inspection result normal?

- YES >> GO TO 5.  
 NO >> Replace automatic drive positioner control unit. Refer to [ADP-194, "Removal and Installation"](#).

### 5. CHECK CHANGEOVER SWITCH

Check changeover switch.

Refer to [ADP-64, "CHANGEOVER SWITCH : Component Inspection"](#).

Is the inspection result normal?

- YES >> Refer to [GI-39, "Intermittent Incident"](#).

# DOOR MIRROR REMOTE CONTROL SWITCH

## < COMPONENT DIAGNOSIS >

NO >> Replace door mirror remote control switch. Refer to [IP-11, "Exploded View"](#).

### 6. CHECK INTERMITTENT INCIDENT

Check intermittent incident.

Refer to [GI-39, "Intermittent Incident"](#).

Is the inspection result normal?

YES >> Replace automatic drive positioner control unit. Refer to [ADP-194, "Removal and Installation"](#).

NO >> Repair or replace the malfunctioning parts.

## CHANGEOVER SWITCH : Component Inspection

INFOID:000000003900323

### 1. CHECK CHANGEOVER SWITCH

Check door mirror remote control switch.

Terminal		Change over switch condition	Continuity
Door mirror remote control switch			
2	13	LEFT	Yes
		Other than above	No
3		RIGHT	Yes
		Other than above	No

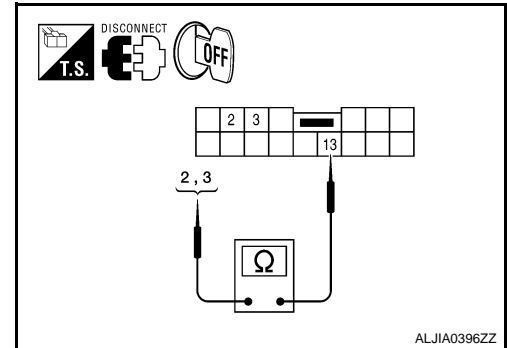

ALJIA0396ZZ

Is the inspection result normal?

YES >> Inspection End.

NO >> Replace door mirror remote control switch. Refer to [IP-11, "Exploded View"](#).

## MIRROR SWITCH

### MIRROR SWITCH : Description

INFOID:000000003900324

It operates angle of the door mirror face.

It transmits mirror face adjust operation to automatic drive positioner control unit.

### MIRROR SWITCH : Component Function Check

INFOID:000000003900325

#### 1. CHECK FUNCTION

1. Select "MIR CON SW-UP/DN", "MIR CON SW-RH/LH" in "Data monitor" mode with CONSULT-III.

2. Check tilt switch signal under the following conditions.

Monitor item	Condition		Status
MIR CON SW-UP/DN	Mirror switch (up/down)	Operate	ON
		Release	OFF
MIR CON SW-RH/LH	Mirror switch (right/left)	Operate	ON
		Release	OFF

Is the indication normal?

YES >> Inspection End.

NO >> Perform diagnosis procedure. Refer to [ADP-64, "MIRROR SWITCH : Diagnosis Procedure"](#).

### MIRROR SWITCH : Diagnosis Procedure

INFOID:000000003900326

#### 1. CHECK MIRROR SWITCH FUNCTION



# DOOR MIRROR REMOTE CONTROL SWITCH

## < COMPONENT DIAGNOSIS >

1. Turn ignition switch ON.
2. Check voltage between automatic drive positioner control unit connector and ground.

Terminals		(-)	Mirror switch Condition	Voltage (V) (Approx.)
(+)	Terminal			
Automatic drive positioner control unit connector M63	3	Ground	UP	0
			Other than above	5
	4		LEFT	0
			Other than above	5
	15		DOWN	0
			Other than above	5
	16		RIGHT	0
			Other than above	5

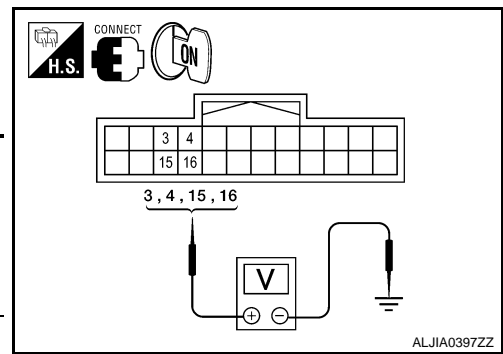

Is the inspection result normal?

- YES >> GO TO 6  
NO >> GO TO 2

## 2. CHECK HARNESS CONTINUITY

1. Turn ignition switch OFF.
2. Disconnect automatic drive positioner control unit and door mirror remote control switch.
3. Check continuity between automatic drive positioner control unit connector and door mirror remote control switch connector.

Automatic drive positioner control unit connector	Terminal	Door mirror remote control switch connector	Terminal	Continuity
M63 (A)	3	M108 (B)	6	Yes
	4		5	
	15		14	
	16		4	

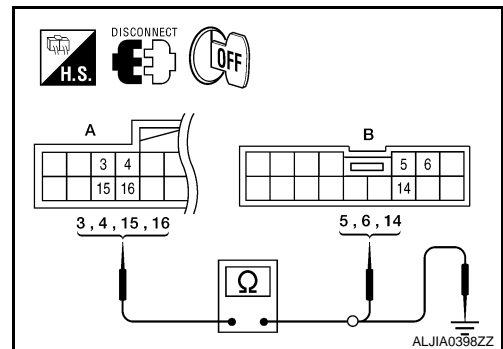

4. Check continuity between automatic drive positioner control unit connector and ground.

Automatic drive positioner control unit connector	Terminal	Continuity
M63 (A)	3	Ground No
	4	
	15	
	16	

Is the inspection result normal?

- YES >> GO TO 3  
NO >> Repair or replace harness.

## 3. CHECK DOOR MIRROR REMOTE CONTROL SWITCH GROUND CIRCUIT

# DOOR MIRROR REMOTE CONTROL SWITCH

## < COMPONENT DIAGNOSIS >

Check continuity between door mirror remote control switch connector and ground.

Door mirror remote control switch connector	Terminal	Ground	Continuity
M108	13		Yes

Is the inspection result normal?

- YES >> GO TO 4  
 NO >> Repair or replace harness.

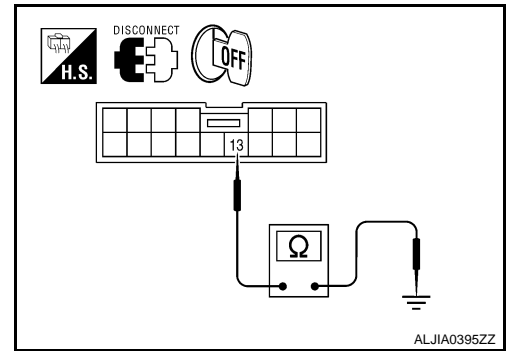

ALJIA0395ZZ

## 4. CHECK AUTOMATIC DRIVE POSITIONER CONTROL UNIT OUTPUT SIGNAL

1. Connect automatic drive positioner control unit.
2. Turn ignition switch ON.
3. Check voltage between automatic drive positioner control unit and ground.

Terminals		(-)	Voltage (V) (Approx.)
(+)	Terminal		
Automatic drive positioner control unit connector	3	Ground	5
	4		
	15		
	16		
M63			

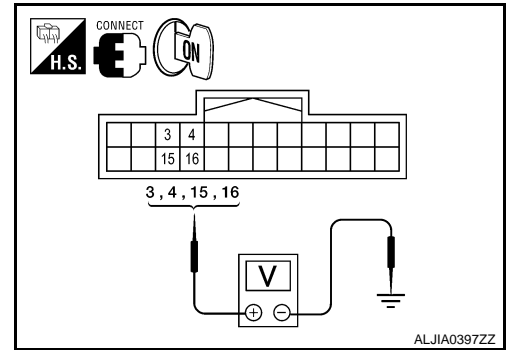

ALJIA0397ZZ

Is the inspection result normal?

- YES >> GO TO 5  
 NO >> Replace automatic drive positioner control unit. Refer to [ADP-194, "Removal and Installation"](#).

## 5. CHECK MIRROR SWITCH

Check mirror switch.

Refer to [ADP-66, "MIRROR SWITCH : Component Inspection"](#).

Is the inspection result normal?

- YES >> Refer to [GI-39, "Intermittent Incident"](#).  
 NO >> Replace door mirror remote control switch. Refer to [IP-11, "Exploded View"](#).

## 6. CHECK INTERMITTENT INCIDENT

Check intermittent incident.

Refer to [GI-39, "Intermittent Incident"](#).

Is the inspection result normal?

- YES >> Replace automatic drive positioner control unit. Refer to [ADP-194, "Removal and Installation"](#).  
 NO >> Repair or replace the malfunctioning parts.

## MIRROR SWITCH : Component Inspection

INFOID:000000003900327

### 1. CHECK MIRROR SWITCH

# DOOR MIRROR REMOTE CONTROL SWITCH

## < COMPONENT DIAGNOSIS >

Check door mirror remote control switch.

Terminal		Mirror switch condition	Continuity
Door mirror remote control switch			
4	13	RIGHT	Yes
		Other than above	No
5		LEFT	Yes
		Other than above	No
6		UP	Yes
		Other than above	No
14		DOWN	Yes
		Other than above	No

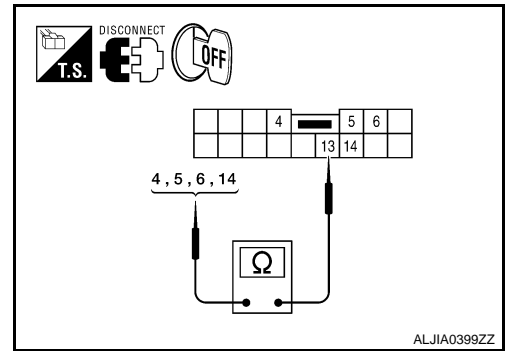

Is the inspection result normal?

YES >> Inspection End.

NO >> Replace door mirror remote control switch. Refer to [IP-11, "Exploded View"](#).

A  
B  
C  
D  
E  
F  
G  
H  
I  
K  
L  
M  
N  
O  
P

ADP

# POWER SEAT SWITCH GROUND CIRCUIT

< COMPONENT DIAGNOSIS >

## POWER SEAT SWITCH GROUND CIRCUIT

### Diagnosis Procedure

INFOID:000000003900328

#### 1. CHECK POWER SEAT SWITCH LH GROUND CIRCUIT

1. Turn ignition switch OFF.
2. Disconnect power seat switch LH.
3. Check continuity between power seat switch LH connector and ground.

Power seat switch LH connector	Terminal	Ground	Continuity
B213	4		Yes

Is the inspection result normal?

- YES >> Check intermittent incident. Refer to [GI-39. "Intermittent Incident"](#).
- NO >> Repair or replace harness.

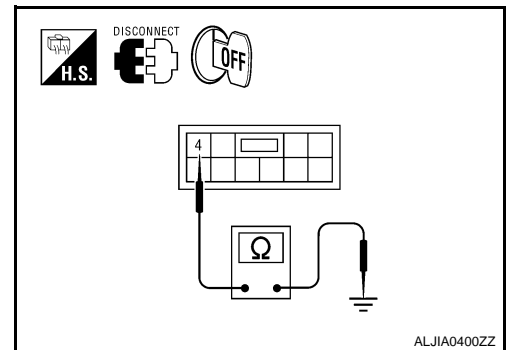

# TILT & TELESCOPIC SWITCH GROUND CIRCUIT

< COMPONENT DIAGNOSIS >

## TILT & TELESCOPIC SWITCH GROUND CIRCUIT

### Diagnosis Procedure

INFOID:000000004363667

#### 1. CHECK ADP STEERING SWITCH (TILT & TELESCOPIC SWITCH) GROUND CIRCUIT

1. Turn ignition switch OFF.
2. Disconnect ADP steering switch (tilt & telescopic switch).
3. Check continuity between ADP steering switch (tilt & telescopic switch) and ground.

ADP steering switch (tilt & telescopic switch)		Ground	Continuity
Connector	Terminal		
M39	1		Yes

Is the inspection result normal?

- YES >> Check intermittent incident. Refer to [GI-39. "Intermittent Incident"](#).
- NO >> Repair or replace harness.

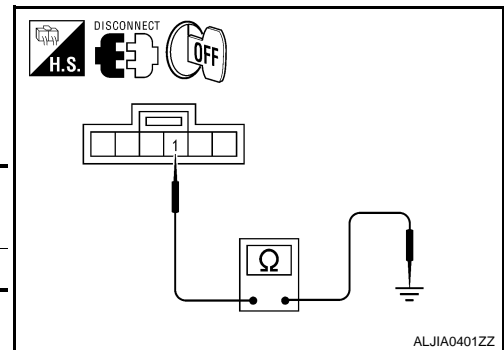

A  
B  
C  
D  
E  
F  
G  
H  
I  
K  
L  
M  
N  
O  
P

ADP

# FRONT DOOR SWITCH (DRIVER SIDE)

< COMPONENT DIAGNOSIS >

## FRONT DOOR SWITCH (DRIVER SIDE)

### Description

INFOID:000000003900332

Detects front door LH open/close condition.

### Component Function Check

INFOID:000000003900333

#### 1. CHECK FUNCTION

1. Select "DOOR SW-DR" in "Data monitor" mode with CONSULT-III.
2. Check the front door switch LH signal under the following conditions.

Monitor item	Condition		Status
DOOR SW-DR	Front door switch LH	Open	ON
		Close	OFF

Is the inspection result normal?

YES >> Inspection End.

NO >> Perform diagnosis procedure. Refer to [ADP-70, "Diagnosis Procedure"](#).

### Diagnosis Procedure

INFOID:000000003900334

#### 1. CHECK FRONT DOOR SWITCH LH CIRCUIT

1. Disconnect BCM.
2. Check continuity between BCM connector and front door switch LH connector.

BCM connector	Terminal	Front door switch LH connector	Terminal	Continuity
M18 (A)	58	B8 (B)	2	Yes

3. Check continuity between BCM connector and ground.

BCM connector	Terminal	Ground	Continuity
M18 (A)	58		No

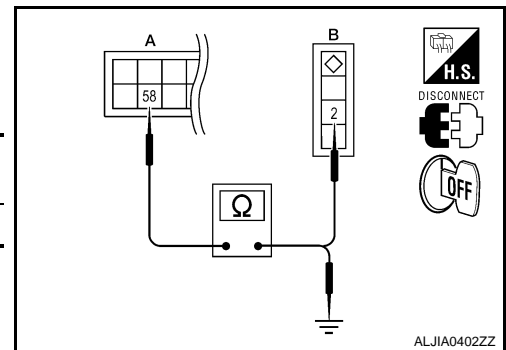

Is the inspection result normal?

YES >> GO TO 2

NO >> Repair or replace harness.

#### 2. CHECK FRONT DOOR SWITCH LH

Refer to [ADP-70, "Component Inspection"](#).

Is the inspection result normal?

YES >> GO TO 3

NO >> Replace front door switch LH.

#### 3. CHECK INTERMITTENT INCIDENT

Refer to [GI-39, "Intermittent Incident"](#).

Is the inspection result normal?

YES >> Replace BCM. Refer to [BCS-87, "Removal and Installation"](#).

NO >> Repair or replace the malfunctioning part.

### Component Inspection

INFOID:000000003900335

#### 1. CHECK FRONT DOOR SWITCH LH

# FRONT DOOR SWITCH (DRIVER SIDE)

## < COMPONENT DIAGNOSIS >

1. Turn ignition switch OFF.
2. Disconnect front door switch LH.
3. Check continuity between front door switch LH terminals.

Terminal		Condition		Continuity
Front door switch LH				
2	Ground part of door switch	Front door switch LH	Pushed	No
			Released	Yes

Is the inspection result normal?

- YES >> Inspection End.  
 NO >> Replace front door switch LH.

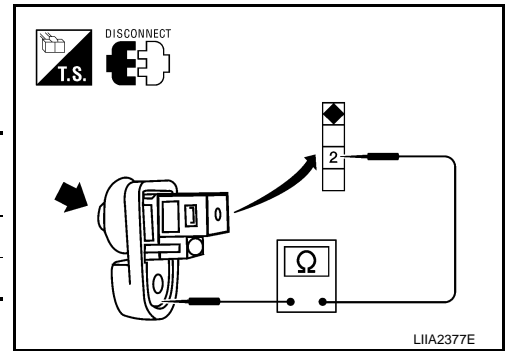

A  
B  
C  
D  
E  
F  
G  
H  
I  
K  
L  
M  
N  
O  
P

ADP

# SLIDING SENSOR

< COMPONENT DIAGNOSIS >

## SLIDING SENSOR

### Description

INFOID:000000003900336

- The sliding sensor is installed to the seat frame.
- The pulse signal is input to the driver seat control unit when sliding is performed.
- The driver seat control unit counts the pulse and calculates the sliding amount of the seat.

### Component Function Check

INFOID:000000003900337

#### 1. CHECK FUNCTION

1. Select "SLIDE PULSE" in "Data monitor" mode with CONSULT-III.
2. Check sliding sensor signal under the following conditions.

Monitor item	Condition		Valve
SLIDE PULSE	Seat sliding	Operate (forward)	Change (increase)
		Operate (backward)	Change (decrease)
		Release	No change

Is the indication normal?

YES >> Inspection End.

NO >> Perform diagnosis procedure. Refer to [ADP-72. "Diagnosis Procedure"](#).

### Diagnosis Procedure

INFOID:000000003900338

#### 1. CHECK SLIDING SENSOR SIGNAL

1. Turn ignition switch ON.
2. Read voltage signal between driver seat control unit harness connector and ground with osilloscope.

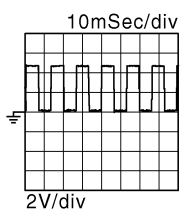
Terminals		Condition	Voltage signal
(+)	(-)		
Driver's seat control unit	Terminal		
B203	18	Seat sliding	 10mSec/div 2V/div JMJIA0119ZZ
		Other than above	0 or 5

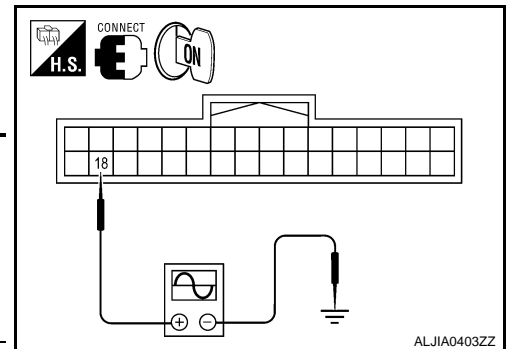

Is the inspection result normal?

YES >> Replace driver seat control unit. Refer to [ADP-193. "Removal and Installation"](#).

NO >> GO TO 2

#### 2. CHECK SLIDING SENSOR CIRCUIT



# SLIDING SENSOR

## < COMPONENT DIAGNOSIS >

1. Turn ignition switch OFF.
2. Disconnect driver seat control unit and front power seat LH (sliding motor).
3. Check continuity between driver seat control unit harness connector and front power seat LH (sliding motor) harness connector.

Driver seat control unit		Front power seat LH (sliding motor)		Continuity
Connector	Terminal	Connector	Terminal	
B203 (A)	18	B206 (B)	12	Yes

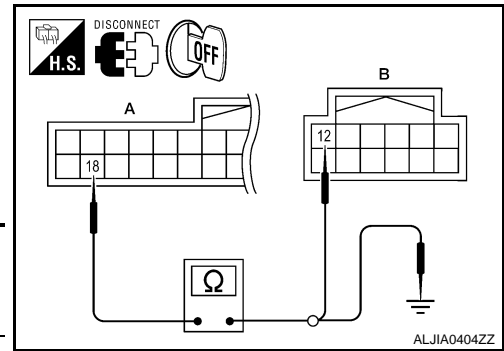

4. Check continuity between driver seat control unit harness connector and ground.

Driver seat control unit		Ground	Continuity
Connector	Terminal		
B203 (A)	18		No

Is the inspection result normal?

- YES >> GO TO 3  
 NO >> Repair or replace harness.

### 3. CHECK SLIDING SENSOR POWER SUPPLY

1. Connect driver seat control unit.
2. Turn ignition switch ON.
3. Check voltage between front power seat LH (sliding motor) harness connector and ground.

(+)		(-)	Voltage (V) (Approx.)
Sliding motor			
Connector	Terminals		
B206	11	Ground	Battery voltage

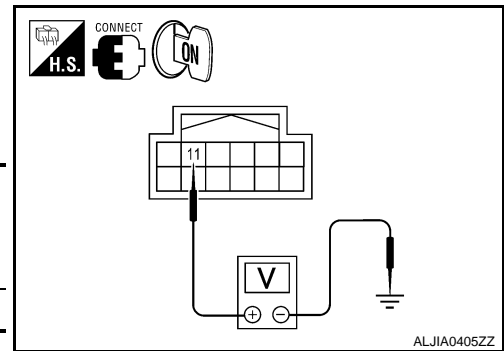

Is the inspection result normal?

- YES >> GO TO 5  
 NO >> GO TO 4

### 4. CHECK SLIDING SENSOR POWER SUPPLY CIRCUIT

1. Turn ignition switch OFF.
2. Disconnect driver seat control unit.
3. Check continuity between driver seat control unit harness connector and front power seat LH (sliding motor) harness connector.

Driver seat control unit		Front power seat LH (sliding motor)		Continuity
Connector	Terminal	Connector	Terminal	
B203 (A)	12	B206 (B)	11	Yes

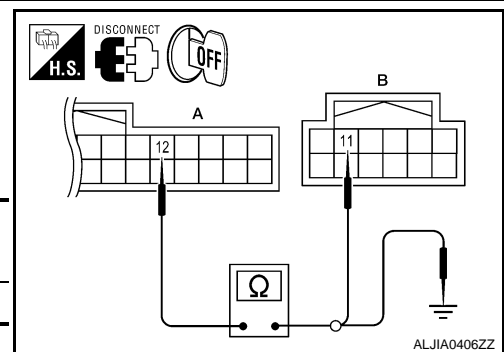

4. Check continuity between driver seat control unit harness connector and ground.

Driver seat control unit		Ground	Continuity
Connector	Terminal		
B203 (A)	12		No

Is the inspection result normal?

- YES >> Replace driver seat control unit. Refer to [ADP-193, "Removal and Installation"](#).

A  
B  
C  
D  
E  
F  
G  
H  
I  
ADP  
K  
L  
M  
N  
O  
P

# SLIDING SENSOR

## < COMPONENT DIAGNOSIS >

NO >> Repair or replace harness.

### 5. CHECK SLIDING SENSOR GROUND

1. Turn ignition switch OFF.
2. Check continuity between front power seat LH (sliding motor) harness connector and ground.

Front power seat LH (sliding motor)		Ground	Continuity
Connector	Terminal		
B206	17		Yes

#### Is the inspection result normal?

YES >> Replace front power seat LH (sliding motor). Refer to [SE-64. "Removal and Installation"](#).

NO >> Repair or replace harness.

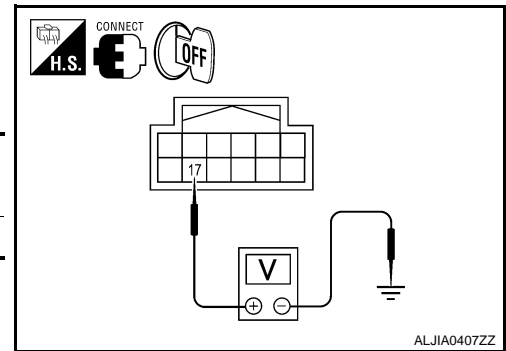

# RECLINING SENSOR

< COMPONENT DIAGNOSIS >

## RECLINING SENSOR

### Description

INFOID:000000003900339

- The reclining motor is installed to the seatback assembly.
- The pulse signal is input to the driver seat control unit when the reclining is operated.
- The driver seat control unit counts the pulse and calculates the reclining amount of the seat.

### Component Function Check

INFOID:000000003900340

#### 1. CHECK FUNCTION

1. Select "RECLN PULSE" in "Data monitor" mode with CONSULT-III.
2. Check reclining sensor signal under the following conditions.

Monitor item	Condition		Value
RECLN PULSE	Seat reclining	Operate (forward)	Change (increase)
		Operate (backward)	Change (decrease)
		Release	No change

Is the indication normal?

YES >> Inspection End.

NO >> Perform diagnosis procedure. Refer to [ADP-75, "Diagnosis Procedure"](#).

### Diagnosis Procedure

INFOID:000000003900341

#### 1. CHECK RECLINING SENSOR SIGNAL

1. Turn ignition switch ON.
2. Read voltage signal between driver seat control unit harness connector and ground with oscilloscope.

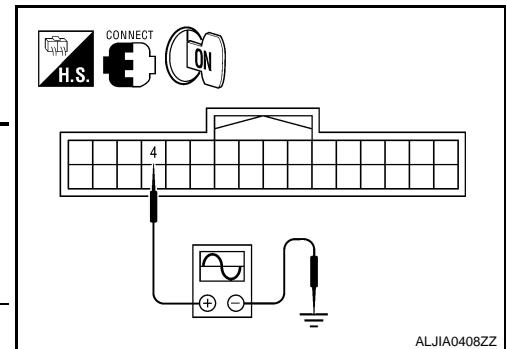

Terminals		Condition	Voltage signal
(+)	(-)		
Driver seat control unit	Terminal		
B203	4	Ground	Operate
		Seat reclining	Other than above

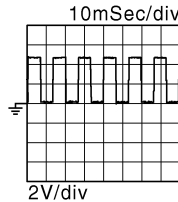

Is the inspection result normal?

YES >> Replace driver seat control unit. Refer to [ADP-193, "Removal and Installation"](#).

NO >> GO TO 2

#### 2. CHECK RECLINING SENSOR CIRCUIT

# RECLINING SENSOR

## < COMPONENT DIAGNOSIS >

1. Turn ignition switch OFF.
2. Disconnect driver seat control unit and reclining motor.
3. Check continuity between driver seat control unit harness connector and reclining motor harness connector.

Driver seat control unit		Reclining motor		Continuity
Connector	Terminal	Connector	Terminal	
B203 (A)	4	B222 (B)	3	Yes

4. Check continuity between driver seat control unit harness connector and ground.

Driver seat control unit		Ground	Continuity
Connector	Terminal		
B203 (A)	4		No

Is the inspection result normal?

- YES >> GO TO 3  
 NO >> Repair or replace harness.

### 3. CHECK RECLINING SENSOR POWER SUPPLY

1. Connect driver seat control unit.
2. Turn ignition switch ON.
3. Check voltage between reclining motor harness connector and ground.

(+)		(-)	Voltage (V) (Approx.)
Reclining motor			
Connector	Terminals		
B222	4	Ground	Battery voltage

Is the inspection result normal?

- YES >> GO TO 5  
 NO >> GO TO 4

### 4. CHECK RECLINING SENSOR POWER SUPPLY CIRCUIT

1. Turn ignition switch OFF.
2. Disconnect driver seat control unit.
3. Check continuity between driver seat control unit harness connector and reclining motor harness connector.

Driver seat control unit		Reclining motor		Continuity
Connector	Terminal	Connector	Terminal	
B203 (A)	12	B222 (B)	4	Yes

4. Check continuity between driver seat control unit harness connector and ground.

Driver seat control unit		Ground	Continuity
Connector	Terminal		
B203 (A)	12		No

Is the inspection result normal?

- YES >> Replace driver seat control unit. Refer to [ADP-193, "Removal and Installation"](#).  
 NO >> Repair or replace harness.

### 5. CHECK RECLINING SENSOR GROUND

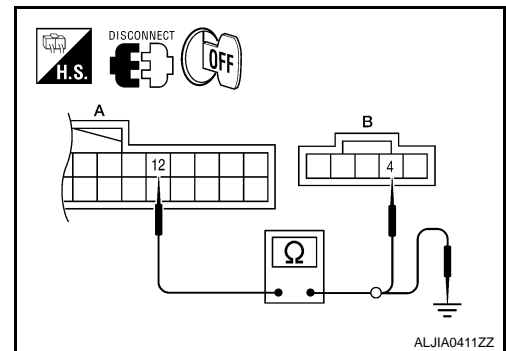
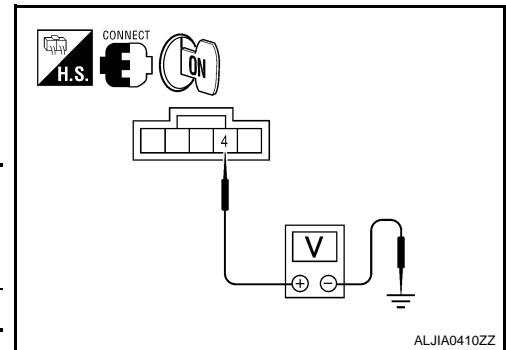
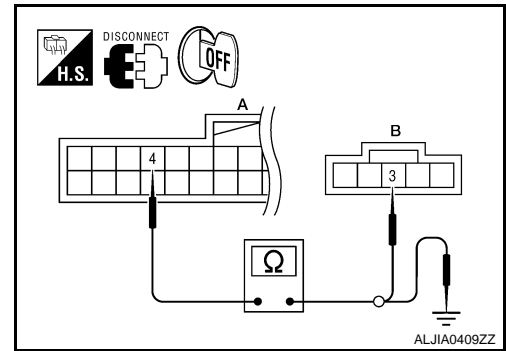

# RECLINING SENSOR

## < COMPONENT DIAGNOSIS >

1. Turn ignition switch OFF.
2. Check continuity between reclining motor harness connector and ground.

Reclining motor		Ground	Continuity
Connector	Terminal		
B222	2		Yes

Is the inspection result normal?

- YES >> Replace reclining motor. Refer to [SE-64. "Removal and Installation"](#).
- NO >> Repair or replace harness.

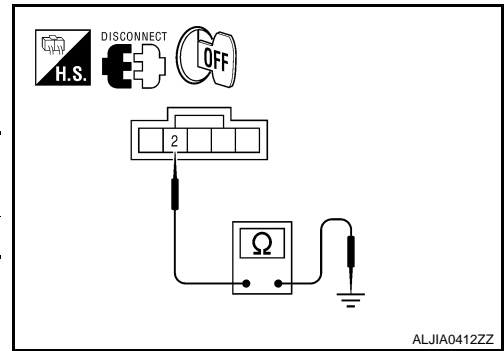

A  
B  
C  
D  
E  
F  
G  
H  
I  
K  
L  
M  
N  
O  
P

ADP

# LIFTING SENSOR (FRONT)

< COMPONENT DIAGNOSIS >

## LIFTING SENSOR (FRONT)

### Description

INFOID:000000003900342

- The lifting sensor (front) is installed to the seat frame.
- The pulse signal is input to the driver seat control unit when the lifting (front) is operated.
- The driver seat control unit counts the pulse and calculates the lifting (front) amount of the seat.

### Component Function Check

INFOID:000000003900343

#### 1. CHECK FUNCTION

1. Select "LIFT FR PULSE" in "Data monitor" mode with CONSULT-III.
2. Check the lifting sensor (front) signal under the following conditions.

Monitor item	Condition		Value
LIFT FR PULSE	Seat lifting (front)	Operate (up)	Change (increase)
		Operate (down)	Change (decrease)
	Release	No change	

Is the indication normal?

YES >> Inspection End.

NO >> Perform diagnosis procedure. Refer to [ADP-78. "Diagnosis Procedure"](#).

### Diagnosis Procedure

INFOID:000000003900344

#### 1. CHECK LIFTING SENSOR (FRONT) SIGNAL

1. Turn ignition switch ON.
2. Read the voltage signal between driver seat control unit harness connector and ground with an oscilloscope.

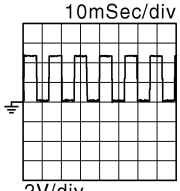
Terminals		Condition	Voltage signal
(+)	(-)		
Driver seat control unit connector	Terminal		
B203	19	Seat lifting (front)	 <p>10mSec/div 2V/div</p>
		Other than above	0 or 5

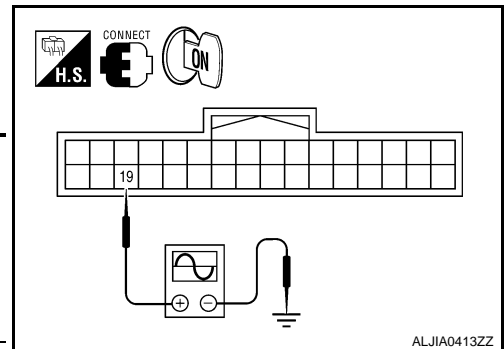

Is the inspection result normal?

YES >> GO TO 4

NO >> GO TO 2

#### 2. CHECK LIFTING SENSOR (FRONT) CIRCUIT

# LIFTING SENSOR (FRONT)

## < COMPONENT DIAGNOSIS >

1. Turn ignition switch OFF.
2. Disconnect driver seat control unit and front power seat LH [lifting motor (front)].
3. Check continuity between driver seat control unit harness connector and front power seat LH [lifting motor (front)] harness connector.

Driver seat control unit		Front power seat LH [lifting motor (front)]		Continuity
Connector	Terminal	Connector	Terminal	
B203 (A)	19	B206 (B)	10	Yes

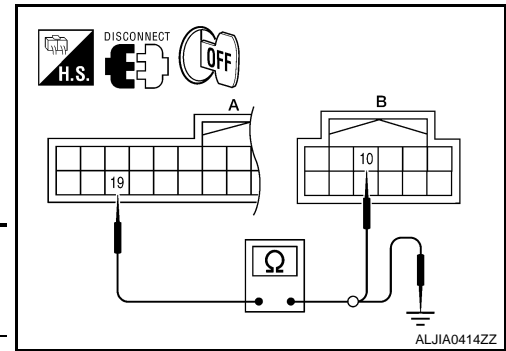

4. Check continuity between driver seat control unit harness connector and ground.

Driver seat control unit		Ground	Continuity
Connector	Terminal		
B203 (A)	19		No

Is the inspection result normal?

- YES >> GO TO 3  
 NO >> Repair or replace harness.

### 3. CHECK LIFTING SENSOR (FRONT) POWER SUPPLY

1. Connect driver seat control unit.
2. Turn ignition switch ON.
3. Check voltage between front power seat LH [lifting motor (front)] harness connector and ground.

(+)		(-)	Voltage (V) (Approx.)
Connector	Terminals		
B206	9	Ground	Battery voltage

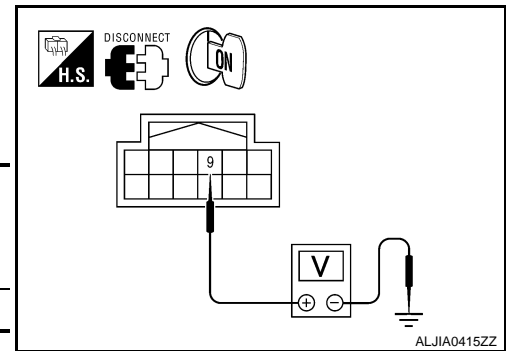

Is the inspection result normal?

- YES >> GO TO 5  
 NO >> GO TO 4

### 4. CHECK LIFTING SENSOR (FRONT) POWER SUPPLY CIRCUIT

1. Turn ignition switch OFF.
2. Disconnect driver seat control unit.
3. Check continuity between driver seat control unit harness connector and front power seat LH [lifting motor (front)] harness connector.

Driver seat control unit		Front power seat LH [lifting motor (front)]		Continuity
Connector	Terminal	Connector	Terminal	
B203 (A)	12	B206 (B)	9	Yes

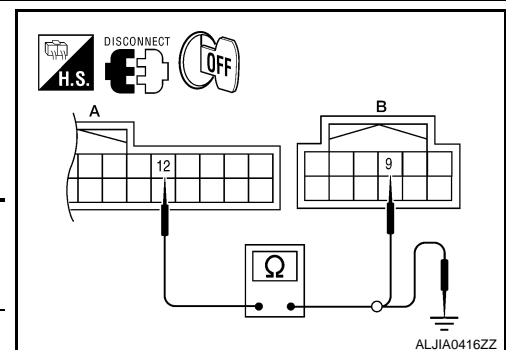

4. Check continuity between driver seat control unit harness connector and ground.

Driver seat control unit		Ground	Continuity
Connector	Terminal		
B203 (A)	12		No

Is the inspection result normal?

A  
B  
C  
D  
E  
F  
G  
H  
I  
ADP  
K  
L  
M  
N  
O  
P

# LIFTING SENSOR (FRONT)

## < COMPONENT DIAGNOSIS >

YES >> Replace driver seat control unit. Refer to [ADP-193. "Removal and Installation"](#).

NO >> Repair or replace harness.

### 5. CHECK LIFTING SENSOR (FRONT) GROUND

1. Turn ignition switch OFF.
2. Check continuity between front power seat LH [lifting motor (front)] harness connector and ground.

Front power seat LH [lifting motor (front)]		Ground	Continuity
Connector	Terminal		
B206	15		Yes

Is the inspection result normal?

YES >> Replace front power seat LH [lifting motor (front)]. Refer to [SE-64. "Removal and Installation"](#).

NO >> Repair or replace harness.

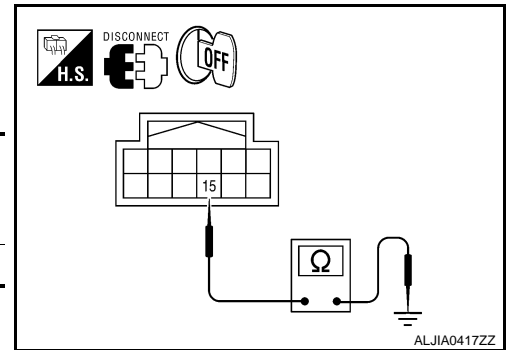



# LIFTING SENSOR (REAR)

< COMPONENT DIAGNOSIS >

## LIFTING SENSOR (REAR)

### Description

INFOID:000000003900345

- The lifting sensor (rear) is installed to the seat frame.
- The pulse signal is input to the driver seat control unit when the lifting (rear) is operated.
- The driver seat control unit counts the pulse and calculates the lifting (rear) amount of the seat.

### Component Function Check

INFOID:000000003900346

#### 1. CHECK FUNCTION

1. Select "LIFT RR PULSE" in "Data monitor" mode with CONSULT-III.
2. Check lifting sensor (rear) signal under the following conditions.

Monitor item	Condition		Value
LIFT RR PULSE	Seat lifting (rear)	Operate (up)	Change (increase)
		Operate (down)	Change (decrease)
	Release	No change	

Is the indication normal?

YES >> Inspection End.

NO >> Perform diagnosis procedure. Refer to [ADP-81, "Diagnosis Procedure"](#).

### Diagnosis Procedure

INFOID:000000003900347

#### 1. CHECK LIFTING SENSOR (REAR) SIGNAL

1. Turn ignition switch ON.
2. Read voltage signal between driver seat control unit harness connector and ground with oscilloscope.

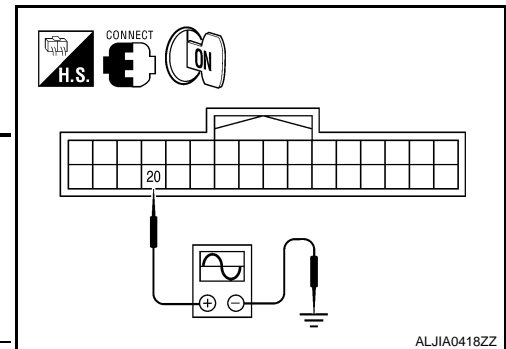

Terminals		(-)	Condition	Voltage signal
(+)	Terminal			
Driver seat control unit connector				
B203	20	Ground	Operate Seat lifting (rear)	
			Other than above	0 or 5

Is the inspection result normal?

YES >> Replace driver seat control unit. Refer to [ADP-193, "Removal and Installation"](#).

NO >> GO TO 2

#### 2. CHECK LIFTING SENSOR (REAR) CIRCUIT

# LIFTING SENSOR (REAR)

## < COMPONENT DIAGNOSIS >

1. Turn ignition switch OFF.
2. Disconnect driver seat control unit and front power seat LH [lifting motor (rear)].
3. Check the continuity between driver seat control unit harness connector and front power seat LH [lifting motor (rear)] harness connector.

Driver seat control unit		Front power seat LH [lifting motor (rear)]		Continuity
Connector	Terminal	Connector	Terminal	
B203 (A)	20	B206 (B)	8	Yes

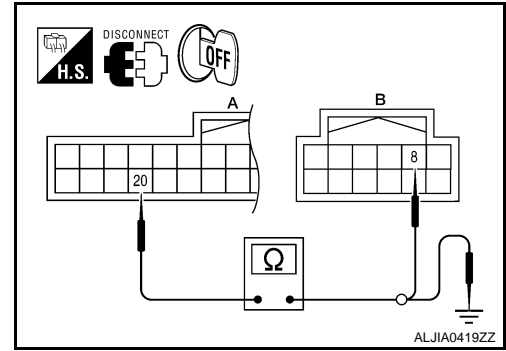

4. Check the continuity between driver seat control unit harness connector and ground.

Driver seat control unit		Ground	Continuity
Connector	Terminal		
B203 (A)	20		No

Is the inspection result normal?

- YES >> GO TO 3  
 NO >> Repair or replace harness.

### 3. CHECK LIFTING SENSOR (REAR) POWER SUPPLY

1. Connect driver seat control unit.
2. Turn ignition switch ON.
3. Check the voltage between front power seat LH [lifting motor (rear)] harness connector and ground.

(+)		(-)	Voltage (V) (Approx.)
Connector	Terminals		
B206	7	Ground	Battery voltage

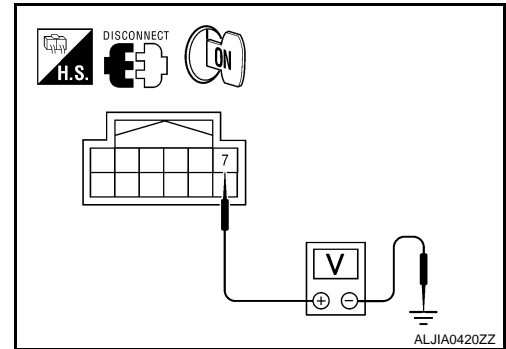

Is the inspection result normal?

- YES >> GO TO 5  
 NO >> GO TO 4

### 4. CHECK LIFTING SENSOR (REAR) POWER SUPPLY CIRCUIT

1. Turn ignition switch OFF.
2. Disconnect driver seat control unit.
3. Check the continuity between driver seat control unit harness connector and front power seat LH [lifting motor (rear)] harness connector.

Driver seat control unit		Front power seat LH [lifting motor (rear)]		Continuity
Connector	Terminal	Connector	Terminal	
B203 (A)	12	B206 (B)	7	Yes

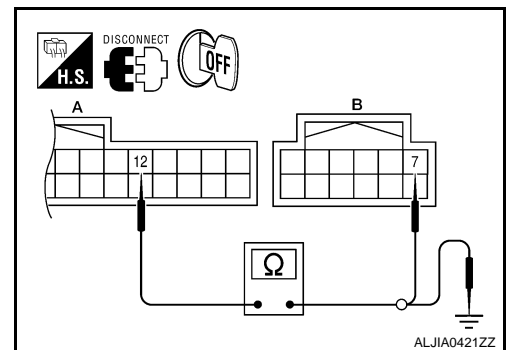

4. Check the continuity between driver seat control unit harness connector and ground.

Driver seat control unit		Ground	Continuity
Connector	Terminal		
B203 (A)	12		No

Is the inspection result normal?

# LIFTING SENSOR (REAR)

## < COMPONENT DIAGNOSIS >

YES >> Replace driver seat control unit. Refer to [ADP-193, "Removal and Installation"](#).

NO >> Repair or replace harness.

### 5. CHECK LIFTING SENSOR (REAR) GROUND

1. Turn ignition switch OFF.
2. Check the continuity between front power seat LH [lifting motor (rear)] harness connector and ground.

Front power seat LH [lifting motor (rear)]		Ground	Continuity
Connector	Terminal		Yes
B206	13		

#### Is the inspection result normal?

YES >> Replace front power seat LH [lifting motor (rear)]. Refer to [SE-64, "Removal and Installation"](#).

NO >> Repair or replace harness.

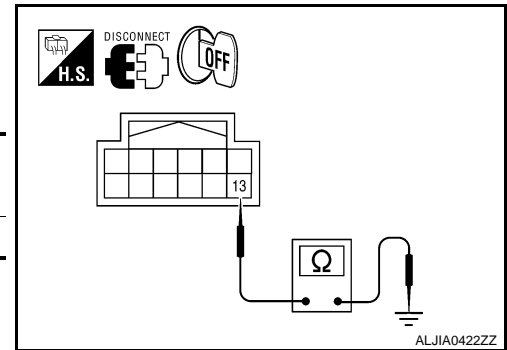

A  
B  
C  
D  
E  
F  
G  
H  
I  
K  
L  
M  
N  
O  
P

ADP

# TILT SENSOR

< COMPONENT DIAGNOSIS >

## TILT SENSOR

### Description

INFOID:000000004363671

- The tilt sensor is installed to the steering column assembly.
- The pulse signal is input to the driver seat control unit when the tilt is operated.
- The driver seat control unit counts the pulse and calculates the tilt amount of the steering column.

### Component Function Check

INFOID:000000004363672

#### 1. CHECK FUNCTION

1. Select "TILT PULSE" in "Data monitor" mode with CONSULT-III.
2. Check tilt sensor signal under the following conditions.

Monitor item	Condition		Value
TILT PULSE	Steering column	Operate (UP-WARD)	Change (increase)
		Operate (DOWN-WARD)	Change (decrease)
		Release	No change

Is the indication normal?

YES >> Inspection End.

NO >> Perform diagnosis procedure. Refer to [ADP-56. "Diagnosis Procedure"](#).

### Diagnosis Procedure

INFOID:000000004363673

#### 1. CHECK TILT SENSOR SIGNAL

1. Turn ignition switch ON.
2. Check voltage signal between driver seat control unit connector and ground with oscilloscope.

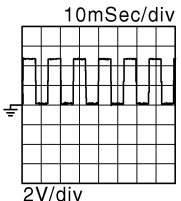
(+)		(-)	Condition	Voltage (V) (Approx.)
Driver seat control unit	Terminals			
Con-connector	Terminals			
B203	21	Ground	Steering column	Operate  2V/div JMJA0119ZZ
				Other than above

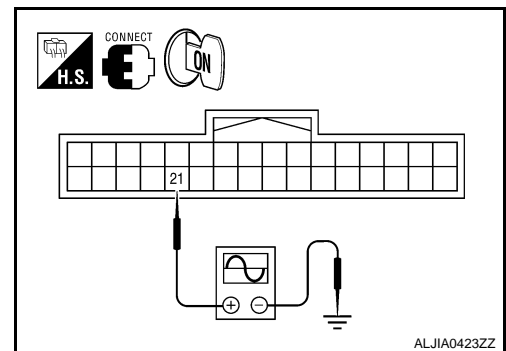

Is the inspection result normal?

YES >> Replace driver seat control unit. Refer to [ADP-193. "Removal and Installation"](#).

NO >> GO TO 2

#### 2. CHECK TILT SENSOR CIRCUIT

# TILT SENSOR

## < COMPONENT DIAGNOSIS >

1. Turn ignition switch OFF.
2. Disconnect driver seat control unit and tilt motor.
3. Check continuity between driver seat control unit harness connector and tilt motor harness connector.

Driver seat control unit		Tilt motor		Continuity
Connector	Terminal	Connector	Terminal	
B203 (A)	21	M71 (B)	5	Yes

4. Check continuity between driver seat control unit harness connector and ground.

Driver seat control unit		Ground	Continuity
Connector	Terminal		
B203 (A)	21		No

Is the inspection result normal?

- YES >> GO TO 3  
 NO >> Repair or replace harness.

### 3. CHECK TILT SENSOR POWER SUPPLY

1. Connect driver seat control unit.
2. Turn ignition switch ON.
3. Check voltage between tilt motor harness connector and ground.

(+)		(-)	Voltage (V) (Approx.)
Tilt motor			
Connector	Terminals		
M71	4	Ground	Battery voltage

Is the inspection result normal?

- YES >> GO TO 5  
 NO >> GO TO 4

### 4. CHECK TILT SENSOR POWER SUPPLY CIRCUIT

1. Turn ignition switch OFF.
2. Disconnect automatic drive positioner control unit.
3. Check continuity between automatic drive positioner control unit harness connector and tilt motor harness connector.

Automatic drive positioner control unit		Tilt motor		Continuity
Connector	Terminal	Connector	Terminal	
M67 (A)	27	M71 (B)	4	Yes

4. Check continuity between automatic drive positioner control unit harness connector and ground.

Automatic drive positioner control unit		Ground	Continuity
Connector	Terminal		
M67 (A)	27		No

Is the inspection result normal?

- YES >> Replace automatic drive positioner control unit. Refer to [ADP-194, "Removal and Installation"](#).  
 NO >> Repair or replace harness or connector.

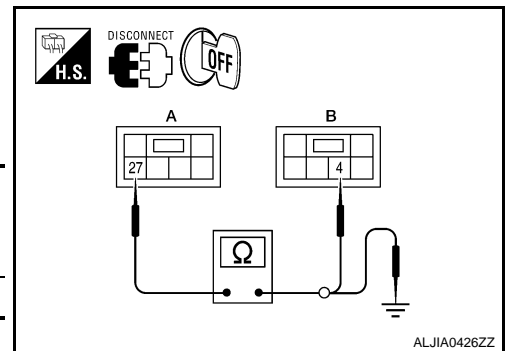
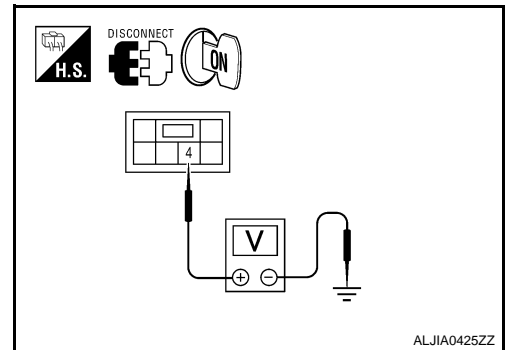
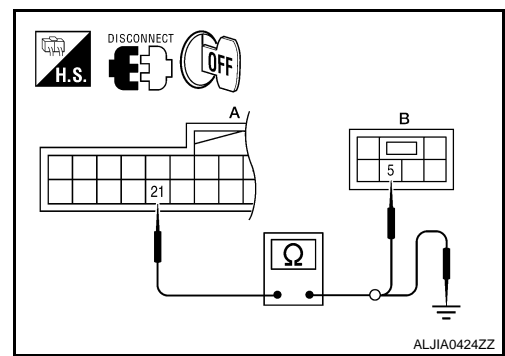

A  
B  
C  
D  
E  
F  
G  
H  
I  
ADP  
K  
L  
M  
N  
O  
P

# TILT SENSOR

## < COMPONENT DIAGNOSIS >

### 5. CHECK TILT SENSOR GROUND CIRCUIT

1. Turn ignition switch OFF.
2. Disconnect automatic drive positioner control unit.
3. Check continuity between automatic drive positioner control unit harness connector and tilt motor harness connector.

Automatic drive positioner control unit		Tilt motor		Continuity
Connector	Terminal	Connector	Terminal	
M63 (A)	20	M71 (B)	6	Yes

Is the inspection result normal?

- YES >> Replace tilt motor. Refer to [ST-28. "Disassembly and Assembly"](#).
- NO >> Repair or replace harness.

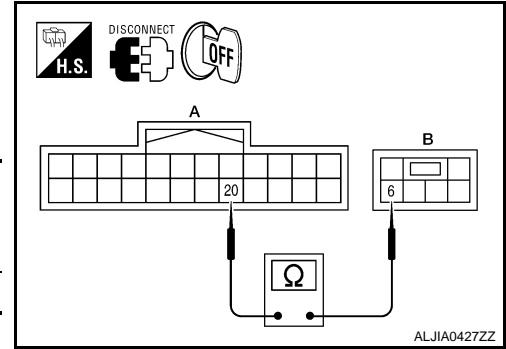

# TELESCOPIC SENSOR

< COMPONENT DIAGNOSIS >

## TELESCOPIC SENSOR

### Description

INFOID:000000004363668

- The telescopic sensor is installed to the steering column assembly.
- The pulse signal is input to the driver seat control unit when telescopic is performed.
- The driver seat control unit counts the pulse and calculates the telescopic amount of the steering column.

### Component Function Check

INFOID:000000004363669

#### 1. CHECK FUNCTION

1. Select "TELESCO PULSE" in "Data monitor" mode with CONSULT-III.
2. Check telescopic sensor signal under the following conditions.

Monitor item	Condition		Valve
TELESCO PULSE	Steering column	Operate (forward)	Change (increase)
		Operate (backward)	Change (decrease)
		Release	No change

Is the indication normal?

- YES >> Inspection End.  
 NO >> Perform diagnosis procedure. Refer to [ADP-87, "Diagnosis Procedure"](#).

### Diagnosis Procedure

INFOID:000000004363670

#### 1. CHECK TELESCOPIC SENSOR SIGNAL

1. Turn ignition switch ON.
2. Check voltage signal between driver seat control unit connector and ground with oscilloscope.

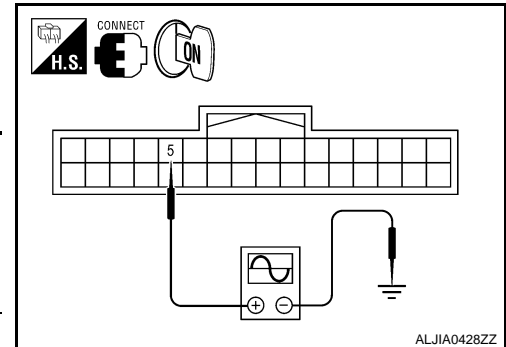

(+)		(-)	Condition	Voltage (V) (Approx.)
Driver seat control unit	Connector			
	Terminals			
B203	5	Ground	Steering column	<p>10mSec/div 2V/div JMJA0119ZZ</p>
			Other than above	0 or 5

Is the inspection result normal?

- YES >> Replace driver seat control unit. Refer to [ADP-193, "Removal and Installation"](#).  
 NO >> GO TO 2

#### 2. CHECK TELESCOPIC SENSOR CIRCUIT

# TELESCOPIC SENSOR

## < COMPONENT DIAGNOSIS >

1. Turn ignition switch OFF.
2. Disconnect driver seat control unit and telescopic motor.
3. Check continuity between driver seat control unit harness connector and telescopic motor harness connector.

Driver seat control unit		Telescopic motor		Continuity
Connector	Terminal	Connector	Terminal	
B203 (A)	5	M73 (B)	5	Yes

4. Check continuity between driver seat control unit harness connector and ground.

Driver seat control unit		Ground	Continuity
Connector	Terminal		
B203 (A)	5		No

Is the inspection result normal?

- YES >> GO TO 3  
 NO >> Repair or replace harness.

### 3. CHECK TELESCOPIC SENSOR POWER SUPPLY

1. Connect driver seat control unit.
2. Turn ignition switch ON.
3. Check voltage between telescopic motor harness connector and ground.

(+)		(-)	Voltage (V) (Approx.)
Telescopic motor			
Connector	Terminals		
M73	4	Ground	Battery voltage

Is the inspection result normal?

- YES >> GO TO 5  
 NO >> GO TO 4

### 4. CHECK TELESCOPIC SENSOR POWER SUPPLY CIRCUIT

1. Turn ignition switch OFF.
2. Disconnect automatic drive positioner control unit.
3. Check continuity between automatic drive positioner control unit harness connector and telescopic motor harness connector.

Automatic drive positioner control unit		Telescopic motor		Continuity
Connector	Terminal	Connector	Terminal	
M67 (A)	27	M73 (B)	4	Yes

4. Check continuity between automatic drive positioner control unit harness connector and ground.

Automatic drive positioner control unit		Ground	Continuity
Connector	Terminal		
M67 (A)	27		No

Is the inspection result normal?

- YES >> Replace automatic drive positioner control unit. Refer to [ADP-194, "Removal and Installation"](#).  
 NO >> Repair or replace harness.

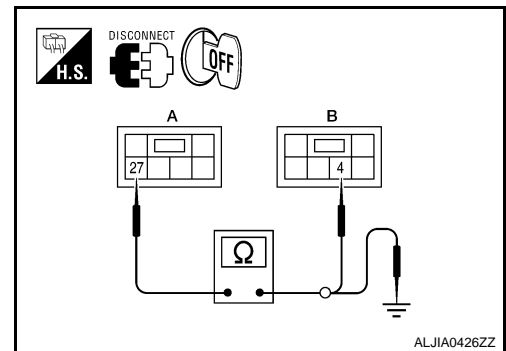
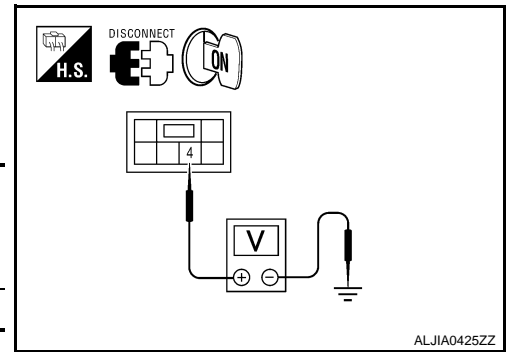
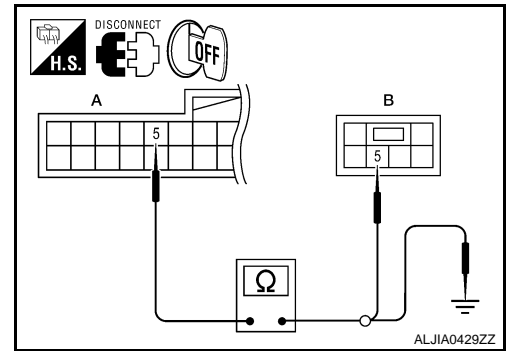



# TELESCOPIC SENSOR

## < COMPONENT DIAGNOSIS >

### 5. CHECK TELESCOPIC SENSOR GROUND CIRCUIT

1. Turn ignition switch OFF.
2. Disconnect automatic drive positioner control unit.
3. Check continuity between automatic drive positioner control unit harness connector and telescopic motor harness connector.

Automatic drive positioner control unit		Telescopic motor		Continuity
Connector	Terminal	Connector	Terminal	
M63 (A)	20	M73 (B)	6	Yes

Is the inspection result normal?

- YES >> Replace telescopic motor. Refer to [ST-28, "Disassembly and Assembly"](#).
- NO >> Repair or replace harness.

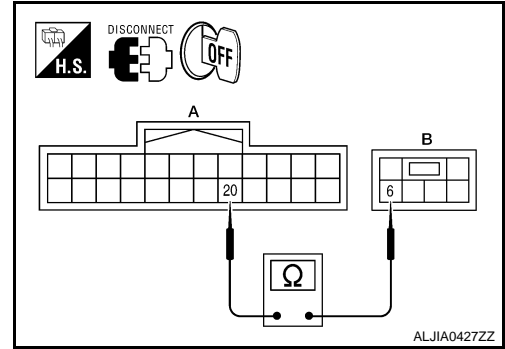

A  
B  
C  
D  
E  
F  
G  
H  
I  
K  
L  
M  
N  
O  
P

ADP

# MIRROR SENSOR

< COMPONENT DIAGNOSIS >

## MIRROR SENSOR DRIVER SIDE

### DRIVER SIDE : Description

INFOID:000000003900351

- The mirror sensor LH is installed to the door mirror LH.
- The resistance of 2 sensors (horizontal and vertical) is changed when the door mirror LH is operated.
- Automatic drive positioner control unit calculates the door mirror position according to the change of the voltage of 2 sensor input terminals.

### DRIVER SIDE : Component Function Check

INFOID:000000003900352

#### 1. CHECK FUNCTION

1. Select "MIR/SEN LH U-D", "MIR/SEN LH R-L" in "Data monitor" with CONSULT-III.
2. Check mirror sensor (driver side) signal under the following condition.

Monitor item	Condition		Value
MIR/SEN LH U-D	Door mirror LH	Close to peak	3.4V
		Close to valley	0.6V
MIR/SEN LH R-L		Close to right edge	3.4V
		Close to left edge	0.6V

Is the indication normal?

YES >> Inspection End.

NO >> Perform diagnosis procedure. Refer to [ADP-90, "DRIVER SIDE : Diagnosis Procedure"](#).

### DRIVER SIDE : Diagnosis Procedure

INFOID:000000003900353

#### 1. CHECK DOOR MIRROR LH SENSOR SIGNAL

1. Turn ignition switch to ACC.
2. Check voltage between door mirror LH harness connector and ground.

Terminals		(-)	Condition	Voltage (V) (Approx.)	
(+)	Terminal				
Door mirror LH connector	12	Ground	Door mirror LH	Close to peak	3.4
	D4			11	Close to valley
Close to right edge					3.4
				Close to left edge	0.6

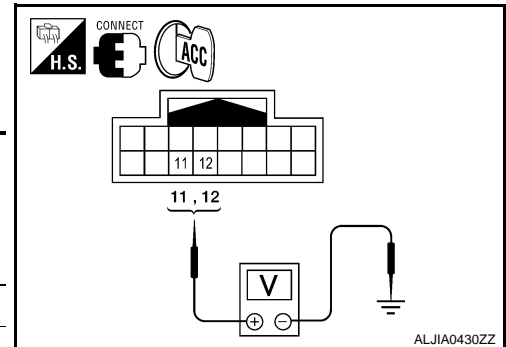

Is the inspection result normal?

YES >> GO TO 5

NO >> GO TO 2

#### 2. CHECK DOOR MIRROR LH SENSOR CIRCUIT 1

# MIRROR SENSOR

## < COMPONENT DIAGNOSIS >

1. Turn ignition switch OFF.
2. Disconnect automatic drive positioner control unit and door mirror LH connector.
3. Check continuity between automatic drive positioner control unit harness connector and door mirror LH harness connector.

Automatic drive positioner control unit connector	Terminal	Door mirror LH connector	Terminal	Continuity
M63 (A)	6	D4 (B)	12	Yes
	18		11	

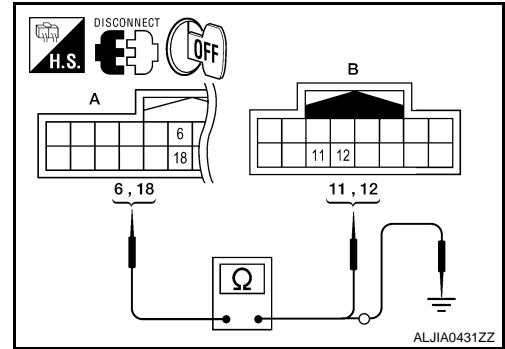

4. Check continuity between automatic drive positioner control unit harness connector and ground.

Automatic drive positioner control unit connector	Terminal	Ground	Continuity
M63 (A)	6	Ground	No
	18		

Is the inspection result normal?

YES >> GO TO 3

NO >> Repair or replace harness.

## 3. CHECK DOOR MIRROR LH SENSOR CIRCUIT 2

1. Check continuity between automatic drive positioner control unit harness connector and door mirror LH harness connector.

Automatic drive positioner control unit connector	Terminal	Door mirror LH connector	Terminal	Continuity
M63 (A)	20	D4 (B)	9	Yes
	21		10	

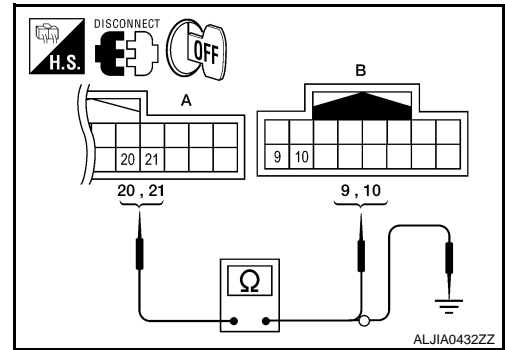

2. Check continuity between automatic drive positioner control unit harness connector and ground.

Automatic drive positioner control unit connector	Terminal	Ground	Continuity
M63 (A)	20	Ground	No
	21		

Is the inspection result normal?

YES >> GO TO 4

NO >> Repair or replace harness.

## 4. CHECK TILT MOTOR ADJUSTING OPERATION

1. Connect automatic drive positioner control unit and door mirror LH.
2. Turn ignition switch ON.
3. Check tilt motor adjusting operation with memory function.

Is the operation normal?

YES >> Replace door mirror actuator. (Built in door mirror LH). Refer to [MIR-19, "Removal and Installation"](#).

NO >> Replace automatic drive positioner control unit. Refer to [ADP-194, "Removal and Installation"](#).

## 5. CHECK INTERMITTENT INCIDENT

Refer to [GI-39, "Intermittent Incident"](#).

Is the inspection result normal?

YES >> Replace automatic drive positioner control unit. Refer to [ADP-194, "Removal and Installation"](#).

# MIRROR SENSOR

## < COMPONENT DIAGNOSIS >

NO >> Repair or replace the malfunctioning part.

### PASSENGER SIDE

#### PASSENGER SIDE : Description

INFOID:000000003900354

- The mirror sensor RH is installed to the door mirror RH.
- The resistance of 2 sensors (horizontal and vertical) is changed when the door mirror RH is operated.
- Automatic drive positioner control unit calculates the door mirror position according to the change of the voltage of 2 sensor input terminals.

#### PASSENGER SIDE : Component Function Check

INFOID:000000003900355

### 1. CHECK FUNCTION

1. Select "MIR/SEN RH U-D", "MIR/SEN RH R-L" in "Data monitor" with CONSULT-III.
2. Check the mirror sensor RH signal under the following conditions.

Monitor item	Condition	Value
MIR/SEN RH U-D	Close to peak	3.4V
	Close to valley	0.6V
MIR/SEN RH R-L	Close to right edge	3.4V
	Close to left edge	0.6V

Is the indication normal?

YES >> Inspection End.

NO >> Perform diagnosis procedure. Refer to [ADP-92. "PASSENGER SIDE : Diagnosis Procedure"](#).

#### PASSENGER SIDE : Diagnosis Procedure

INFOID:000000003900356

### 1. CHECK DOOR MIRROR RH SENSOR SIGNAL

1. Turn ignition switch to ACC.
2. Check voltage between door mirror RH harness connector and ground.

Terminals		(-)	Condition	Voltage (V) (Approx.)	
(+)	Terminal				
Door mirror RH connector		Ground	Door mirror RH	Close to peak	3.4
	12		Close to valley	0.6	
	11		Close to right edge	3.4	
D107			Close to left edge	0.6	

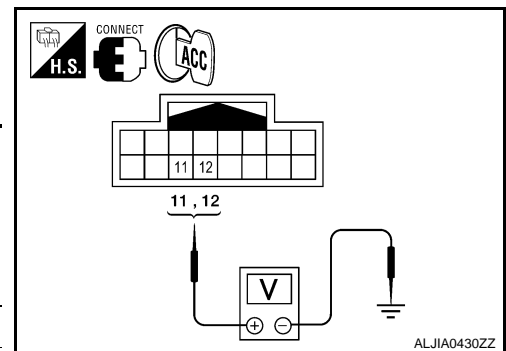

Is the inspection result normal?

YES >> GO TO 5

NO >> GO TO 2

### 2. CHECK DOOR MIRROR RH SENSOR CIRCUIT 1

# MIRROR SENSOR

## < COMPONENT DIAGNOSIS >

1. Turn ignition switch OFF.
2. Disconnect automatic drive positioner control unit and door mirror RH.
3. Check continuity between automatic drive positioner control unit harness connector and door mirror RH harness connector.

Automatic drive positioner control unit connector	Terminal	Door mirror RH connector	Terminal	Continuity
M63 (A)	5	D107 (B)	12	Yes
	17		11	

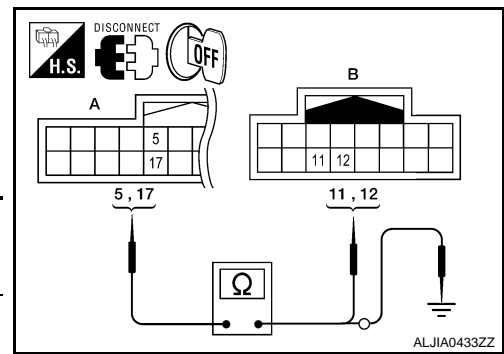

4. Check continuity between automatic drive positioner control unit harness connector and ground.

Automatic drive positioner control unit connector	Terminal	Ground	Continuity
M63 (A)	5	Ground	No
	17		

Is the inspection result normal?

YES >> GO TO 3

NO >> Repair or replace harness.

## 3. CHECK DOOR MIRROR RH SENSOR CIRCUIT 2

1. Check continuity between automatic drive positioner control unit harness connector and door mirror RH harness connector.

Automatic drive positioner control unit connector	Terminal	Door mirror RH connector	Terminal	Continuity
M63 (A)	20	D107 (B)	9	Yes
	21		10	

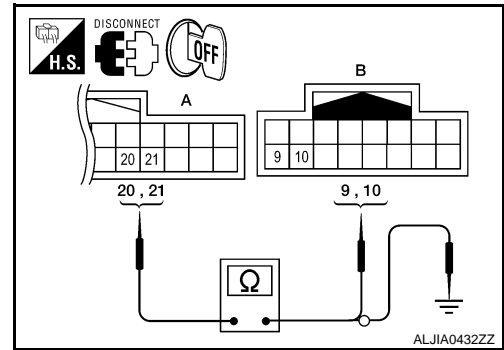

2. Check continuity between automatic drive positioner control unit harness connector and ground.

Automatic drive positioner control unit connector	Terminal	Ground	Continuity
M63 (A)	20	Ground	No
	21		

Is the inspection result normal?

YES >> GO TO 4

NO >> Repair or replace harness.

## 4. CHECK TILT MOTOR ADJUSTING OPERATION

1. Connect automatic drive positioner control unit and door mirror RH.
2. Turn ignition switch ON.
3. Check tilt motor adjusting operation with memory function.

Is the operation normal?

YES >> Replace door mirror actuator. (Built in door mirror RH). Refer to [MIR-19, "Removal and Installation"](#).

NO >> Replace automatic drive positioner control unit. Refer to [ADP-194, "Removal and Installation"](#).

## 5. CHECK INTERMITTENT INCIDENT

Refer to [GI-39, "Intermittent Incident"](#).

Is the inspection result normal?

YES >> Replace automatic drive positioner control unit. Refer to [ADP-194, "Removal and Installation"](#).

## MIRROR SENSOR

### < COMPONENT DIAGNOSIS >

---

NO >> Repair or replace the malfunctioning part.

# SLIDING MOTOR

< COMPONENT DIAGNOSIS >

## SLIDING MOTOR

### Description

INFOID:000000003900357

- The sliding motor LH is installed to the seat frame.
- The sliding motor LH is activated with the driver seat control unit.
- The seat is slid forward/backward by changing the rotation direction of sliding motor LH.

### Component Function Check

INFOID:000000003900358

#### 1. CHECK FUNCTION

1. Select "SEAT SLIDE" in "Active test" mode with CONSULT-III.
2. Check the sliding motor LH operation.

Test Item		Description	
SEAT SLIDE	OFF	Seat sliding	Stop
	FR		Forward
	RR		Backward

Is the operation of relevant parts normal?

- YES >> Inspection End.  
 NO >> Perform diagnosis procedure. Refer to [ADP-95, "Diagnosis Procedure"](#).

### Diagnosis Procedure

INFOID:000000003900359

#### 1. CHECK SLIDING MOTOR LH POWER SUPPLY

1. Turn the ignition switch to ACC.
2. Perform "Active test" ("SEAT SLIDE") with CONSULT-III
3. Check voltage between driver seat control unit harness connector and ground.

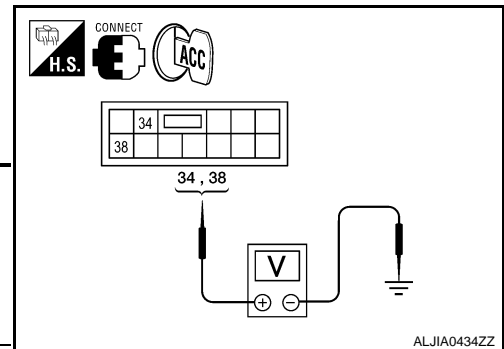

Terminal (+)		Terminal (-)	Test Item	Voltage (V) (Approx.)
Driver seat control unit connector	Terminal			
B211	34	Ground	SEAT SLIDE OFF	0
			FR (forward)	Battery voltage
			RR (backward)	0
	38		SEAT SLIDE OFF	0
			FR (forward)	0
			RR (backward)	Battery voltage

Is the inspection result normal?

- YES >> Replace front power seat LH [sliding motor]. Refer to [SE-64, "Removal and Installation"](#).  
 NO >> GO TO 2

#### 2. CHECK SLIDING MOTOR LH CIRCUIT

# SLIDING MOTOR

## < COMPONENT DIAGNOSIS >

1. Turn ignition switch OFF.
2. Disconnect driver seat control unit and front power seat LH [sliding motor].
3. Check continuity between driver seat control unit harness connector and front power seat LH [sliding motor] harness connector.

Driver seat control unit connector	Terminal	Front power seat LH [sliding motor] connector	Terminal	Continuity
B211 (A)	34	B205 (B)	6	Yes
	38		2	

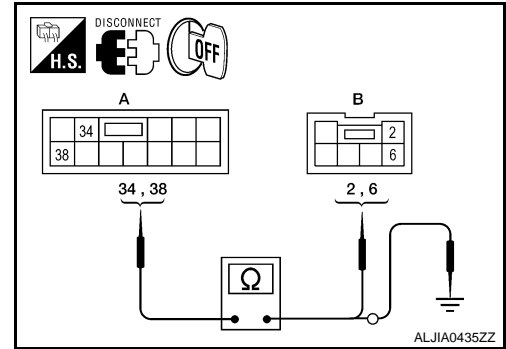

4. Check continuity between driver seat control unit harness connector and ground.

Driver seat control unit connector	Terminal	Ground	Continuity
B211 (A)	34	Ground	No
	38		

Is the inspection result normal?

YES >> GO TO 3

NO >> Repair or replace harness.

### 3. CHECK INTERMITTENT INCIDENT

Refer to [GI-39. "Intermittent Incident"](#).

Is the inspection result normal?

YES >> Replace driver seat control unit. Refer to [ADP-193. "Removal and Installation"](#).

NO >> Repair or replace the malfunctioning part.



# RECLINING MOTOR

< COMPONENT DIAGNOSIS >

## RECLINING MOTOR

### Description

INFOID:000000003900360

- The reclining motor is installed to the seatback assembly.
- The reclining motor is activated with the driver seat control unit.
- The seatback is reclined forward/backward by changing the rotation direction of reclining motor.

### Component Function Check

INFOID:000000003900361

#### 1. CHECK FUNCTION

1. Select "SEAT RECLINING" in "Active test" mode with CONSULT-III.
2. Check the reclining motor LH operation.

Test Item		Description	
SEAT RECLINING	OFF	Seat reclining	Stop
	FR		Forward
	RR		Backward

Is the operation of relevant parts normal?

YES >> Inspection End.

NO >> Perform diagnosis procedure. Refer to [ADP-97, "Diagnosis Procedure"](#).

### Diagnosis Procedure

INFOID:000000003900362

#### 1. CHECK RECLINING MOTOR POWER SUPPLY

1. Turn the ignition switch to ACC.
2. Perform "Active test" ("SEAT RECLINING") with CONSULT-III
3. Check voltage between driver seat control unit harness connector and ground.

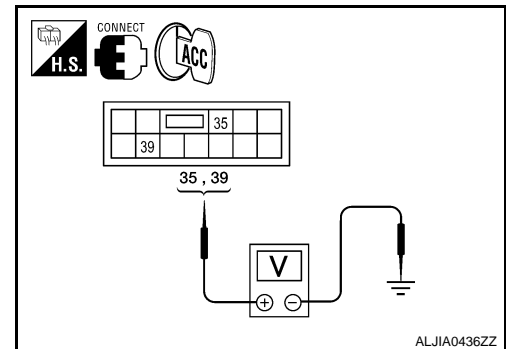

Terminal (+)		Terminal (-)	Test Item	Voltage (V) (Approx.)
Driver seat control unit connector	Terminal			
B211	39	Ground	SEAT RECLINING OFF	0
			SEAT RECLINING FR (forward)	Battery voltage
			SEAT RECLINING RR (backward)	0
	35		SEAT RECLINING OFF	0
			SEAT RECLINING FR (forward)	0
			SEAT RECLINING RR (backward)	Battery voltage

Is the inspection result normal?

YES >> Replace reclining motor. (Built in seatback assembly). Refer to [SE-64, "Removal and Installation"](#).

NO >> GO TO 2

#### 2. CHECK RECLINING MOTOR CIRCUIT

# RECLINING MOTOR

## < COMPONENT DIAGNOSIS >

1. Turn ignition switch OFF.
2. Disconnect driver seat control unit and reclining motor.
3. Check continuity between driver seat control unit harness connector and reclining motor harness connector.

Driver seat control unit connector	Terminal	Reclining motor connector	Terminal	Continuity
B211 (A)	35	B222 (B)	5	Yes
	39		1	

4. Check continuity between driver seat control unit harness connector and ground.

Driver seat control unit connector	Terminal	Ground	Continuity
B211 (A)	35	Ground	No
	39		

Is the inspection result normal?

- YES >> GO TO 3  
 NO >> Repair or replace harness.

### 3. CHECK INTERMITTENT INCIDENT

Refer to [GI-39. "Intermittent Incident"](#).

Is the inspection result normal?

- YES >> Replace driver seat control unit. Refer to [ADP-193. "Removal and Installation"](#).  
 NO >> Repair or replace the malfunctioning part.

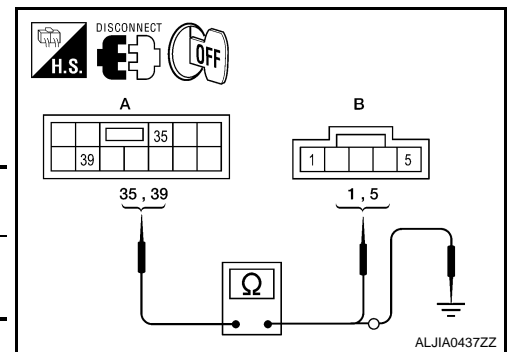

# LIFTING MOTOR (FRONT)

< COMPONENT DIAGNOSIS >

## LIFTING MOTOR (FRONT)

### Description

INFOID:000000003900363

- The lifting motor (front) is installed to the seat frame.
- The lifting motor (front) is activated with the driver seat control unit.
- The lifter (front) is moved upward/downward by changing the rotation direction of lifting motor (front).

### Component Function Check

INFOID:000000003900364

#### 1. CHECK FUNCTION

1. Select "SEAT LIFTER FR" in "Active test" mode with CONSULT-III.
2. Check the lifting motor (front) operation.

Test Item		Description	
SEAT LIFTER FR	OFF	Seat lifting (front)	Stop
	UP		Upward
	DWN		Downward

Is the operation of relevant parts normal?

YES >> Inspection End.

NO >> Perform diagnosis procedure. Refer to [ADP-99, "Diagnosis Procedure"](#).

### Diagnosis Procedure

INFOID:000000003900365

#### 1. CHECK LIFTING MOTOR (FRONT) POWER SUPPLY

1. Turn the ignition switch to ACC.
2. Perform "Active test" ("SEAT LIFTER FR") with CONSULT-III.
3. Check voltage between driver seat control unit harness connector and ground.

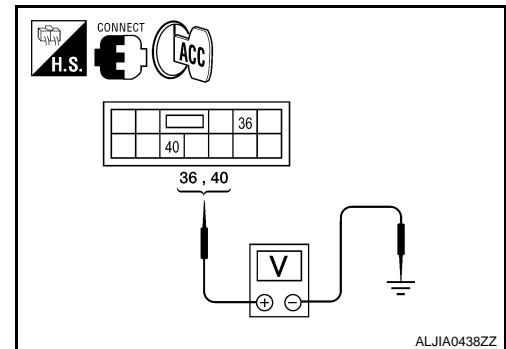

Terminal (+)		Terminal (-)	Test Item	Voltage (V) (Approx.)	
Driver seat control unit connector	Terminal				
B211	40	Ground	SEAT LIFTER FR	OFF	0
			UP	0	
			DWN (down)	Battery voltage	
	36		SEAT LIFTER FR	OFF	0
			UP	Battery voltage	
			DWN (down)	0	

Is the inspection result normal?

YES >> Replace front power seat LH [lifting motor (front)]. Refer to [SE-64, "Removal and Installation"](#).

NO >> GO TO 2

#### 2. CHECK LIFTING MOTOR (FRONT) CIRCUIT

# LIFTING MOTOR (FRONT)

## < COMPONENT DIAGNOSIS >

1. Turn ignition switch OFF.
2. Disconnect driver seat control unit and front power seat LH [lifting motor (front)].
3. Check continuity between driver seat control unit harness connector and front power seat LH [lifting motor (front)] harness connector.

Driver seat control unit connector	Terminal	Front power seat LH [lifting motor (front)] connector	Terminal	Continuity
B211 (A)	36	B205 (B)	5	Yes
	40		4	

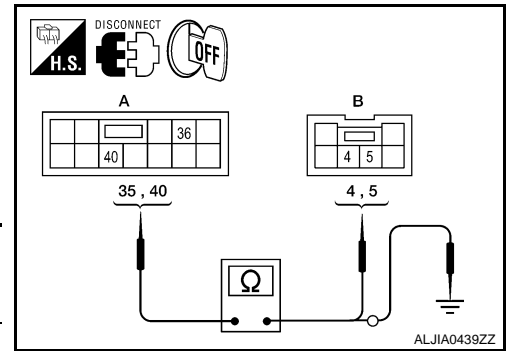

4. Check continuity between driver seat control unit harness connector and ground.

Driver seat control unit connector	Terminal	Ground	Continuity
B211 (A)	36	Ground	No
	40		

Is the inspection result normal?

YES >> GO TO 3

NO >> Repair or replace harness.

### 3. CHECK INTERMITTENT INCIDENT

Refer to [GI-39. "Intermittent Incident"](#).

Is the inspection result normal?

YES >> Replace driver seat control unit. Refer to [ADP-193. "Removal and Installation"](#).

NO >> Repair or replace the malfunctioning part.

# LIFTING MOTOR (REAR)

< COMPONENT DIAGNOSIS >

## LIFTING MOTOR (REAR)

### Description

INFOID:000000003900366

- The lifting motor (rear) is installed to the seat frame.
- The lifting motor (rear) is activated with the driver seat control unit.
- The seat lifter (rear) is moved upward/downward by changing the rotation direction of lifting motor (rear).

### Component Function Check

INFOID:000000003900367

#### 1. CHECK FUNCTION

1. Select "SEAT LIFTER RR" in "Active test" mode with CONSULT-III.
2. Check the lifting motor (rear) operation.

Test Item		Description	
SEAT LIFTER RR	OFF	Seat lifting (rear)	Stop
	UP		Upward
	DWN		Downward

Is the operation of relevant parts normal?

- YES >> Inspection End.  
 NO >> Perform diagnosis procedure. Refer to [ADP-101, "Diagnosis Procedure"](#).

### Diagnosis Procedure

INFOID:000000003900368

#### 1. CHECK LIFTING MOTOR (REAR) POWER SUPPLY

1. Turn the ignition switch to ACC.
2. Perform "Active test" ("SEAT LIFTER RR") with CONSULT-III
3. Check voltage between driver seat control unit harness connector and ground.

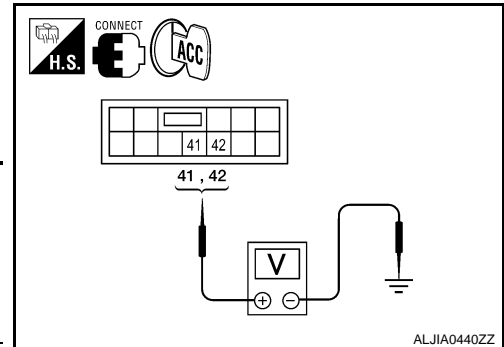

Terminal (+)		Terminal (-)	Test Item	Voltage (V) (Approx.)
Driver seat control unit connector	Terminal			
B211	41	Ground	SEAT LIFTER RR OFF	0
			SEAT LIFTER RR UP	0
			SEAT LIFTER RR DWN (down)	Battery voltage
	42		SEAT LIFTER RR OFF	0
			SEAT LIFTER RR UP	Battery voltage
			SEAT LIFTER RR DWN (down)	0

Is the inspection result normal?

- YES >> Replace front power seat LH [lifting motor (rear)]. Refer to [SE-106, "Removal and Installation"](#).  
 NO >> GO TO 2

#### 2. CHECK LIFTING MOTOR (REAR) CIRCUIT

1. Turn ignition switch OFF.

## LIFTING MOTOR (REAR)

### < COMPONENT DIAGNOSIS >

2. Disconnect driver seat control unit and front power seat LH [lifting motor (rear)].
3. Check continuity between driver seat control unit harness connector and front power seat LH [lifting motor (rear)] harness connector.

Driver seat control unit connector	Terminal	Front power seat LH [lifting motor (rear)] connector	Terminal	Continuity
B211 (A)	41	B205 (B)	1	Yes
	42		3	

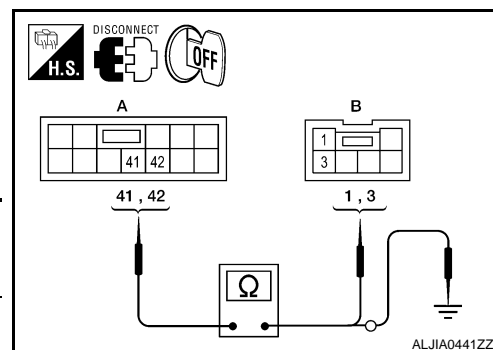

4. Check continuity between driver seat control unit harness connector and ground.

Driver seat control unit connector	Terminal	Ground	Continuity
B211 (A)	41	Ground	No
	42		

Is the inspection result normal?

YES >> GO TO 3

NO >> Repair or replace harness.

### 3. CHECK INTERMITTENT INCIDENT

Refer to [GI-39. "Intermittent Incident"](#).

Is the inspection result normal?

YES >> Replace driver seat control unit. Refer to [ADP-193. "Removal and Installation"](#).

NO >> Repair or replace the malfunctioning part.

# TILT MOTOR

< COMPONENT DIAGNOSIS >

## TILT MOTOR

### Description

INFOID:000000004363678

- The tilt motor is installed to the steering column assembly.
- The tilt motor is activated with the automatic drive positioner control unit.
- The steering column is tilted upward/downward by changing the rotation direction of tilt motor.

### Component Function Check

INFOID:000000004363679

#### 1. CHECK FUNCTION

1. Select "TILT MOTOR" in "Active test" mode with CONSULT-III.
2. Check the tilt motor operation.

Test item		Description	
TILT MOTOR	OFF	Steering tilt	Stop
	UP		Upward
	DWN		Downward

Is the operation of relevant parts normal?

- YES >> Inspection End.  
 NO >> Perform diagnosis procedure. Refer to [ADP-103, "Diagnosis Procedure"](#).

### Diagnosis Procedure

INFOID:000000004363680

#### 1. CHECK TILT MOTOR POWER SUPPLY

1. Turn ignition switch OFF.
2. Disconnect tilt motor.
3. Turn the ignition switch ON.
4. Perform "Active test" ("TILT MOTOR") with CONSULT-III.
5. Check voltage between tilt motor harness connector and ground.

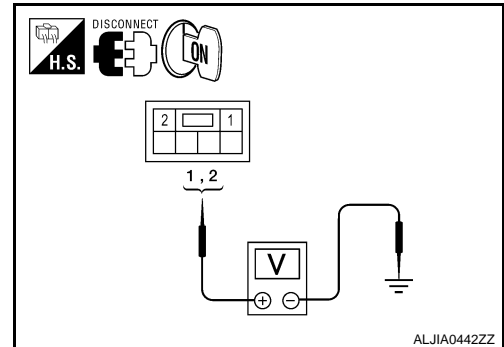

(+)		(-)	Condition	Voltage (V) (Approx.)	
Tilt motor					
Connector	Terminals				
M71	1	Ground	TILT MOTOR	OFF	0
			UP	0	
			DWN (down)	Battery voltage	
	2		TILT MOTOR	OFF	0
			UP	Battery voltage	
			DWN (down)	0	

Is the inspection result normal?

- YES >> Replace tilt motor. (Built in steering column assembly). Refer to [ST-19, "Exploded View"](#).  
 NO >> GO TO 2.

#### 2. CHECK TILT MOTOR CIRCUIT

# TILT MOTOR

## < COMPONENT DIAGNOSIS >

1. Turn ignition switch OFF.
2. Disconnect automatic drive positioner control unit.
3. Check continuity between automatic drive positioner control unit harness connector and tilt motor harness connector.

Automatic drive positioner control unit		Tilt motor		Continuity
Connector	Terminal	Connector	Terminal	
M67 (A)	28	M71 (B)	1	Yes
	29		2	

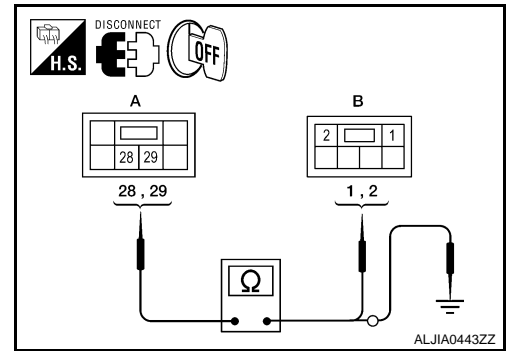

4. Check continuity between automatic drive positioner control unit harness connector and ground.

Automatic drive positioner control unit		Ground	Continuity
Connector	Terminal		
M67 (A)	28		No
	29		

Is the inspection result normal?

- YES >> Replace automatic drive positioner control unit. Refer to [ADP-194. "Removal and Installation"](#).  
 NO >> Repair or replace harness.



# TELESCOPIC MOTOR

< COMPONENT DIAGNOSIS >

## TELESCOPIC MOTOR

### Description

INFOID:000000004363681

- The telescopic motor is installed to the steering column assembly.
- The telescopic motor is activated with the automatic drive positioner control unit.
- Compresses the steering column by changing the rotation direction of telescopic motor.

### Component Function Check

INFOID:000000004363682

#### 1. CHECK FUNCTION

1. Select "TELESCO MOTOR" in "Active test" mode with CONSULT-III.
2. Check the telescopic motor operation.

Test item		Description	
TELESCO MOTOR	OFF	Steering telescopic	Stop
	FR		Forward
	RR		Backward

Is the operation of relevant parts normal?

YES >> Inspection End.

NO >> Perform diagnosis procedure. Refer to [ADP-105, "Diagnosis Procedure"](#).

### Diagnosis Procedure

INFOID:000000004363683

#### 1. CHECK TELESCOPIC MOTOR POWER SUPPLY

1. Turn ignition switch OFF.
2. Disconnect tilt motor.
3. Turn the ignition switch ON.
4. Perform "Active test" ("TELESCO MOTOR") with CONSULT-III
5. Check voltage between telescopic motor harness connector and ground.

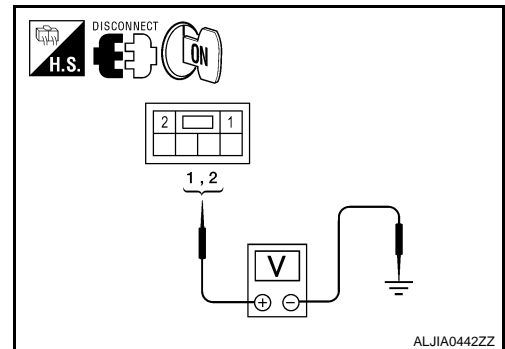

(+)		(-)	Condition	Voltage (V) (Approx.)	
Telescopic motor					
Connector	Terminals				
M73	1	Ground	TELE-SCOPIC MOTOR	OFF	0
			FR (forward)	0	
			RR (backward)	Battery voltage	
	2		OFF	0	
			FR (forward)	Battery voltage	
			RR (backward)	0	

Is the inspection result normal?

YES >> Replace telescopic motor. (Built in steering column assembly). Refer to [ST-19, "Exploded View"](#).

NO >> GO TO 2

#### 2. CHECK TELESCOPIC MOTOR CIRCUIT

# TELESCOPIC MOTOR

## < COMPONENT DIAGNOSIS >

1. Turn ignition switch OFF.
2. Disconnect automatic drive positioner control unit.
3. Check continuity between automatic drive positioner control unit harness connector and telescopic motor harness connector.

Automatic drive positioner control unit		Telescopic motor		Continuity
Connector	Terminal	Connector	Terminal	
M67 (A)	29	M73 (B)	2	Yes
	26		1	

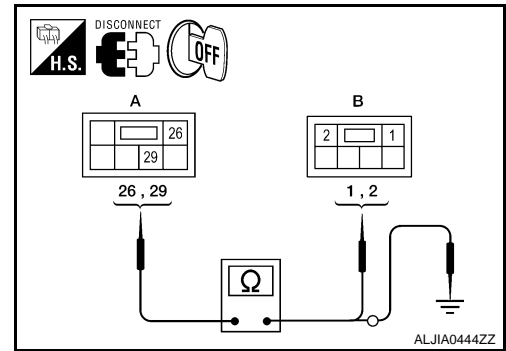

4. Check continuity between automatic drive positioner control unit harness connector and ground.

Automatic drive positioner control unit		Ground	Continuity
Connector	Terminal		
M67 (A)	29		No
	26		

Is the inspection result normal?

- YES >> Replace automatic drive positioner control unit. Refer to [ADP-194. "Removal and Installation"](#).  
 NO >> Repair or replace harness.

# DOOR MIRROR MOTOR

< COMPONENT DIAGNOSIS >

## DOOR MIRROR MOTOR

### Description

INFOID:000000003900372

It makes mirror face operate from side to side and up and down with the electric power that automatic drive positioner control unit supplies.

### Component Function Check

INFOID:000000003900373

#### 1. CHECK DOOR MIRROR MOTOR FUNCTION

Check the operation with "MIRROR MOTOR RH" and "MIRROR MOTOR LH" in "ACTIVE TEST" mode with CONSULT-III

Refer to [ADP-34, "CONSULT-III Function \(AUTO DRIVE POS.\)"](#).

Is the inspection result normal?

YES >> Door mirror motor function is OK.

NO >> Refer to [ADP-107, "Diagnosis Procedure"](#).

### Diagnosis Procedure

INFOID:000000003900374

#### 1. CHECK DOOR MIRROR MOTOR INPUT SIGNAL

1. Turn ignition switch ON.
2. Check voltage between door mirror connector and ground.

Terminals		(-)	Door mirror remote control switch condition	Voltage (V) (Approx.)
(+)	Terminal			
Door mirror connector	1	Ground	UP	Battery voltage
			Other than above	0
	2		LEFT	Battery voltage
			Other than above	0
	3		DOWN / RIGHT	Battery voltage
			Other than above	0

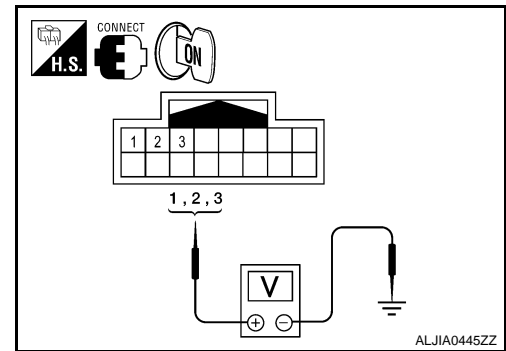

Is the inspection result normal?

YES >> Refer to [ADP-109, "Component Inspection"](#).

NO >> GO TO 2

#### 2. CHECK HARNESS CONTINUITY

1. Turn ignition switch OFF.
2. Disconnect automatic drive positioner control unit and door mirror.
3. Check continuity between automatic drive positioner control unit connector and door mirror connector.

Door mirror LH

Automatic drive positioner control unit connector	Terminal	Door mirror LH connector	Terminal	Continuity
M63 (A)	12	D4 (B)	3	Yes
	23		1	
	24		2	

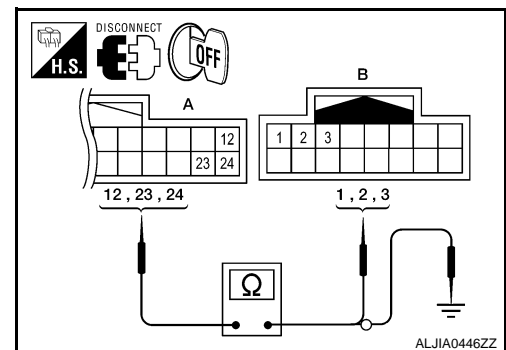

# DOOR MIRROR MOTOR

## < COMPONENT DIAGNOSIS >

Door mirror RH

Automatic drive positioner control unit connector	Terminal	Door mirror RH connector	Terminal	Continuity
M63 (A)	10	D107 (B)	1	Yes
	11		2	
	22		3	

4. Check continuity between automatic drive positioner control unit connector and ground.

Door mirror LH

Automatic drive positioner control unit connector	Terminal	Ground	Continuity
M63 (A)	12	Ground	No
	23		
	24		

Door mirror RH

Automatic drive positioner control unit connector	Terminal	Ground	Continuity
M63 (A)	10	Ground	No
	11		
	22		

Is the inspection result normal?

YES >> GO TO 3

NO >> Repair or replace harness.

### 3. CHECK AUTOMATIC DRIVE POSITIONER CONTROL UNIT OUTPUT SIGNAL

1. Connect automatic drive positioner control unit.
2. Turn ignition switch ON.
3. Check voltage between automatic drive positioner control unit connector and ground.

Door mirror LH

Terminals		(-)	Mirror switch condition	Voltage (V) (Approx.)
(+)	Terminal			
Automatic drive positioner control unit connector	M63	Ground	DOWN / RIGHT	Battery voltage
			Other than above	0
			UP	Battery voltage
			Other than above	0
			LEFT	Battery voltage
			Other than above	0

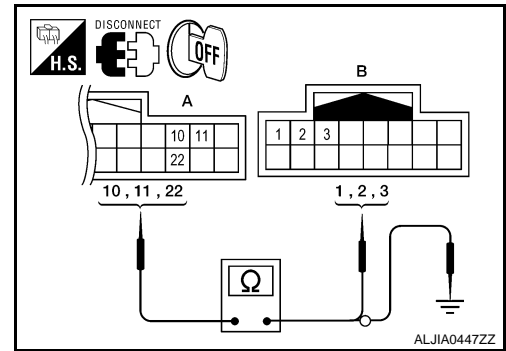

ALJIA0447ZZ

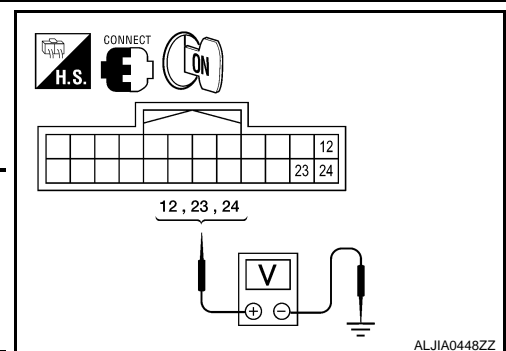

ALJIA0448ZZ

# DOOR MIRROR MOTOR

## < COMPONENT DIAGNOSIS >

Door mirror RH				
Terminals		(-)	Mirror switch condition	Voltage (V) (Approx.)
(+)	Terminal			
Automatic drive positioner control unit connector  M63	10	Ground	UP	Battery voltage
			Other than above	0
	11		LEFT	Battery voltage
			Other than above	0
	22		DOWN / RIGHT	Battery voltage
			Other than above	0

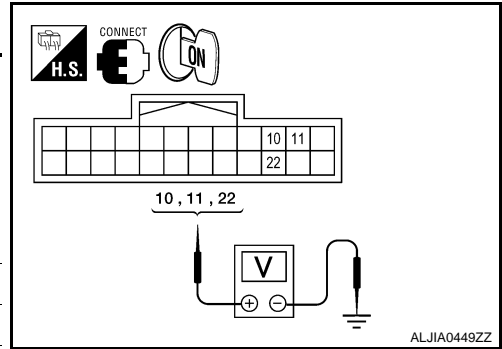

Is the inspection result normal?

YES >> GO TO 4

NO >> Replace automatic drive positioner control unit. Refer to [ADP-194. "Removal and Installation"](#).

### 4. CHECK DOOR MIRROR MOTOR

Check door mirror motor.

Refer to [ADP-109. "Component Inspection"](#).

Is the inspection result normal?

YES >> Refer to [GI-39. "Intermittent Incident"](#).

NO >> Replace door mirror actuator. Refer to [MIR-19. "Removal and Installation"](#).

## Component Inspection

INFOID:000000003900375

### 1. CHECK DOOR MIRROR MOTOR-I

Check that door mirror motor does not trap foreign objects and does not have any damage.

Refer to [MIR-19. "Exploded View"](#).

Is the inspection result normal?

YES >> GO TO 2

NO >> Replace door mirror actuator. Refer to [MIR-19. "Removal and Installation"](#).

### 2. CHECK DOOR MIRROR MOTOR-II

1. Turn ignition switch OFF.
2. Disconnect door mirror.
3. Apply 12V to each power supply terminal of door mirror motor.

Door mirror connector	Terminal		Operational direction
	(+)	(-)	
D4 (LH) D107 (RH)	3	2	RIGHT
	2	3	LEFT
	1	3	UP
	3	1	DOWN

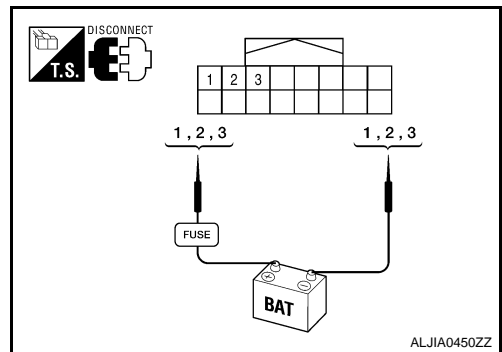

Is the inspection result normal?

YES >> Inspection End.

NO >> Replace door mirror actuator. Refer to [MIR-19. "Removal and Installation"](#).

# SEAT MEMORY INDICATOR LAMP

< COMPONENT DIAGNOSIS >

## SEAT MEMORY INDICATOR LAMP

### Description

INFOID:000000003900376

- Memory switch is equipped on the seat memory switch installed to the driver side door trim. The operation signal is input to the driver seat control unit when the memory switch is operated.
- The status of automatic drive positioner system can be checked according to the illuminating/flashing status.

### Component Function Check

INFOID:000000003900377

#### 1. CHECK FUNCTION

1. Select "MEMORY SW INDCTR" in "Active test" mode with CONSULT-III.
2. Check the memory indicator operation.

Test item		Description	
MEMORY SW INDCTR	OFF	Memory switch indicator	OFF
	ON-1		Indicator 1: ON
	ON-2		Indicator 2: ON

Is the operation of relevant parts normal?

YES >> Inspection End.

NO >> Perform diagnosis procedure. Refer to [ADP-110, "Diagnosis Procedure"](#).

### Diagnosis Procedure

INFOID:000000003900378

#### 1. CHECK SEAT MEMORY INDICATOR CIRCUIT

1. Turn ignition switch OFF.
2. Disconnect driver seat control unit and seat memory switch.
3. Check continuity between driver seat control unit harness connector and seat memory switch harness connector.

Driver seat control unit connector	Terminal	Seat memory switch connector	Terminal	Continuity
B203 (A)	7	D13 (B)	7	Yes
	23		6	

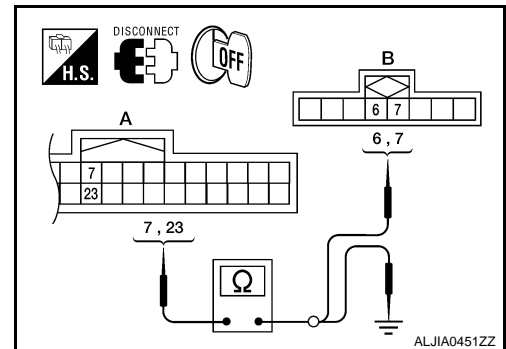

4. Check continuity between driver seat control unit harness connector and ground.

Driver seat control unit connector	Terminal	Ground	Continuity
B203 (A)	7	Ground	No
	23		

Is the inspection result normal?

YES >> GO TO 2

NO >> Repair or replace harness.

#### 2. CHECK MEMORY INDICATOR POWER SUPPLY

# SEAT MEMORY INDICATOR LAMP

## < COMPONENT DIAGNOSIS >

Check voltage between seat memory switch harness connector and ground.

Seat memory switch connector	Terminals		Voltage (V) (Approx.)
	(+)	(-)	
D13	5	Ground	Battery voltage

Is the inspection result normal?

YES >> GO TO 3

NO >> Check the following:

- Fuse
- Harness for open or short between memory indicator and fuse.

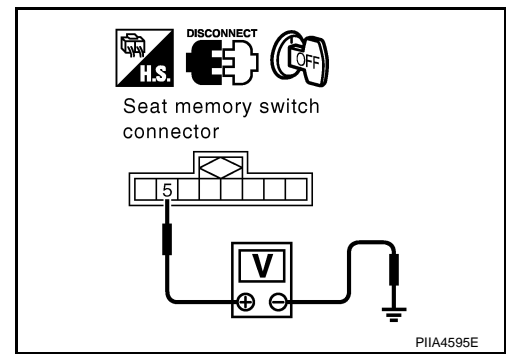

### 3. CHECK MEMORY INDICATOR

Refer to [ADP-111, "Component Inspection"](#).

Is the inspection result normal?

YES >> GO TO 4

NO >> Replace seat memory switch. Refer to [ADP-195, "Removal and Installation"](#).

### 4. CHECK INTERMITTENT INCIDENT

Refer to [GI-39, "Intermittent Incident"](#).

Is the inspection result normal?

YES >> Replace driver seat control unit. Refer to [ADP-193, "Removal and Installation"](#).

NO >> Repair or replace the malfunctioning part.

## Component Inspection

INFOID:000000003900379

### 1. CHECK SEAT MEMORY INDICATOR

1. Disconnect seat memory switch.
2. Check continuity between seat memory switch terminals.

Terminal		Continuity
Seat memory switch		
(+)	(-)	
6	5	Yes
7		

Is the inspection result normal?

YES >> Inspection End.

NO >> Replace seat memory switch. Refer to [ADP-195, "Removal and Installation"](#).

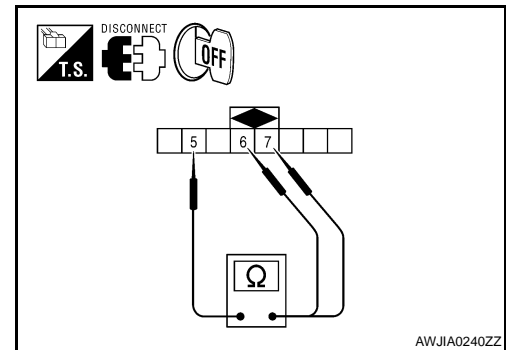

A  
B  
C  
D  
E  
F  
G  
H  
I  
K  
L  
M  
N  
O  
P

ADP

# DRIVER SEAT CONTROL UNIT

< ECU DIAGNOSIS >

## ECU DIAGNOSIS

### DRIVER SEAT CONTROL UNIT

Reference Value

INFOID:000000003900380

VALUES ON THE DIAGNOSIS TOOL

CONSULT-III MONITOR ITEM

Monitor Item	Condition	Value/Status	
SET SW	Set switch	Push	ON
		Release	OFF
MEMORY SW1	Memory switch 1	Push	ON
		Release	OFF
MEMORY SW2	Memory switch 2	Push	ON
		Release	OFF
SLIDE SW-FR	Sliding switch (forward)	Operate	ON
		Release	OFF
SLIDE SW-RR	Sliding switch (backward)	Operate	ON
		Release	OFF
RECLN SW-FR	Reclining switch (forward)	Operate	ON
		Release	OFF
RECLN SW-RR	Reclining switch (backward)	Operate	ON
		Release	OFF
LIFT FR SW-UP	Lifting switch front (up)	Operate	ON
		Release	OFF
LIFT FR SW-DN	Lifting switch front (down)	Operate	ON
		Release	OFF
LIFT RR SW-UP	Lifting switch rear (up)	Operate	ON
		Release	OFF
LIFT RR SW-DN	Lifting switch rear (down)	Operate	ON
		Release	OFF
MIR CON SW-UP	Mirror switch	Up	ON
		Other than above	OFF
MIR CON SW-DN	Mirror switch	Down	ON
		Other than above	OFF
MIR CON SW-RH	Mirror switch	Right	ON
		Other than above	OFF
MIR CON SW-LH	Mirror switch	Left	ON
		Other than above	OFF
MIR CHNG SW-R	Changeover switch	Right	ON
		Other than above	OFF
MIR CHNG SW-L	Changeover switch	Left	ON
		Other than above	OFF
TILT SW-UP	Tilt switch	Upward	ON
		Other than above	OFF
TILT SW-DOWN	Tilt switch	Downward	ON
		Other than above	OFF



# DRIVER SEAT CONTROL UNIT

## < ECU DIAGNOSIS >

Monitor Item	Condition		Value/Status
TELESCO SW-FR	Telescopic switch	Forward	ON
		Other than above	OFF
TELESCO SW-RR	Telescopic switch	Backward	ON
		Other than above	OFF
DETENT SW	A/T selector lever	P position	OFF
		Other than above	ON
STARTER SW	Ignition position	Cranking	ON
		Other than above	OFF
SLIDE PULSE	Seat sliding	Forward	The numeral value decreases *
		Backward	The numeral value increases*
		Other than above	No change to numeral value*
RECLN PULSE	Seat reclining	Forward	The numeral value decreases*
		Backward	The numeral value increases *
		Other than above	No change to numeral value *
LIFT FR PULSE	Seat lifter (front)	Up	The numeral value decreases *
		Down	The numeral value increases *
		Other than above	No change to numeral value *
LIFT RR PULSE	Seat lifter (rear)	Up	The numeral value decreases *
		Down	The numeral value increases *
		Other than above	No change to numeral value *
MIR/SEN RH U-D	Door mirror (passenger side)		Change between 3.4 (close to peak) 0.6 (close to valley)
MIR/SEN RH R-L	Door mirror (passenger side)		Change between 3.4 (close to left edge) 0.6 (close to right edge)
MIR/SEN LH U-D	Door mirror (driver side)		Change between 3.4 (close to peak) 0.6 (close to valley)
MIR/SEN LH R-L	Door mirror (driver side)		Change between 0.6 (close to left edge) 3.4 (close to right edge)
TILT PULSE	Tilt position	Upward	The numeral value decreases *
		Downward	The numeral value increases *
		Other than above	No change to numeral value *
TELESCO PULSE	Telescopic position	Forward	The numeral value decreases *
		Backward	The numeral value increases *
		Other than above	No change to numeral value *
STEERING STATUS	Steering lock unit	LOCK	LOCK
		unlock	UNLOCK
VEHICLE SPEED	The condition of vehicle speed is displayed		km/h
P RANG SW CAN	CVT selector lever	P position	ON
		Other than above	OFF
R RANGE (CAN)	CVT selector lever	R position	ON
		Other than above	OFF
DOOR SW-FL	Driver door	Open	ON
		Close	OFF

A  
B  
C  
D  
E  
F  
G  
H  
I

ADP

K  
L  
M  
N  
O  
P

# DRIVER SEAT CONTROL UNIT

## < ECU DIAGNOSIS >

Monitor Item	Condition		Value/Status
DOOR SW-FR	Passenger door	Open	ON
		Close	OFF
IGN ON SW	Ignition switch	ON position	ON
		Other than above	OFF
ACC ON SW	Ignition switch	ACC or ON position	ON
		Other than above	OFF
KEY ON SW	Intelligent Key	Inserted in key slot	ON
		Not Inserted in key slot	OFF
KEYLESS ID	UNLOCK button of Intelligent Key is pressed		1, 2, 3, 4 or 5
KYL5 DR UNLK	Intelligent Key or driver side door request switch	ON	ON
		OFF	OFF
VHCL SPEED (ABS)	Can signal from ABS	Received	ON
		Not received	OFF

\*: The value at the position attained when the battery is connected is regarded as 32768.

## TERMINAL LAYOUT

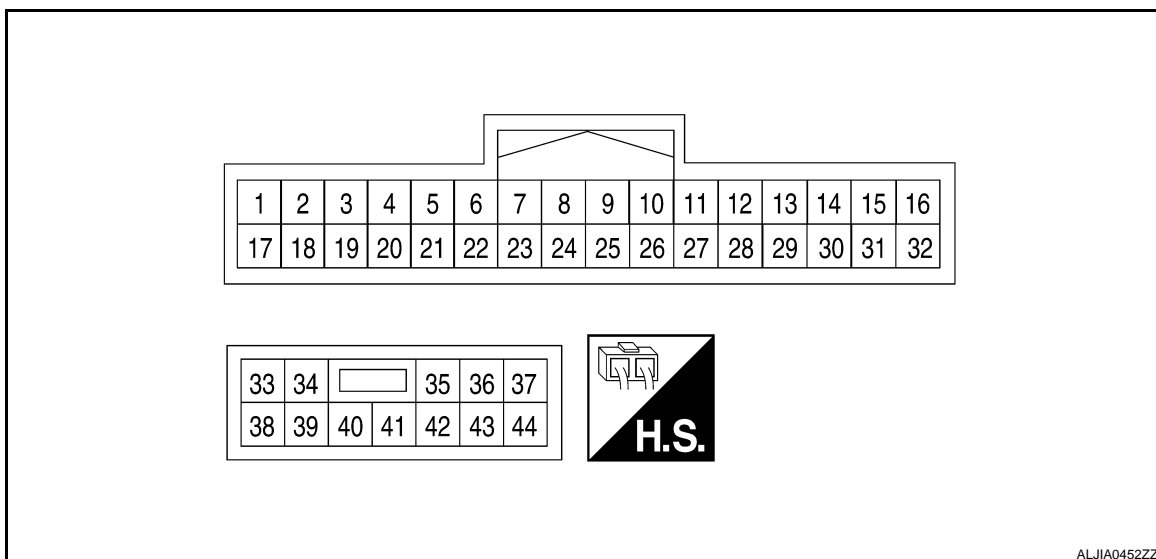

## PHYSICAL VALUES

Terminal No. (wire color)		Description		Condition	Voltage (V) (Approx)
+	-	Signal name	Input/Output		
1 (L)	—	CAN-H	—	—	—
2 (Y/L)	Ground	UART communication (TX/RX)	Input	Ignition switch ON	

# DRIVER SEAT CONTROL UNIT

## < ECU DIAGNOSIS >

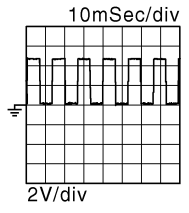
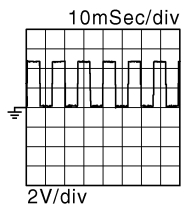
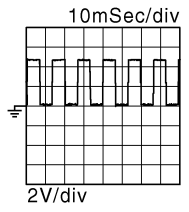
Terminal No. (wire color)		Description		Condition		Voltage (V) (Approx)
+	-	Signal name	Input/ Output			
4 (W)	Ground	Reclining sensor signal	Input	Seat reclining	Operate	
					Stop	
5 (P/Y)	Ground	Telescopic sensor signal	Input	Telescopic	Operate	0 or 5
					Other than above	
6 (O/B)	Ground	Memory switch 2 signal	Input	Memory switch 2	Press	0
					Other than above	5
7 (SB)	Ground	Memory indicator 2 signal	Output	Memory indicator 2	Illuminate	1
					Other than above	Battery voltage
8 (V)	Ground	Sliding switch backward signal	Input	Sliding switch	Operate (backward)	0
					Release	Battery voltage
9 (V)	Ground	Reclining switch backward signal	Input	Reclining switch	Operate (backward)	0
					Release	Battery voltage
10 (L)	Ground	Lifting switch (front) down signal	Input	Lifting switch (front)	Operate (down)	0
					Release	Battery voltage
11 (B)	Ground	Lifting switch (rear) down signal	Input	Lifting switch (rear)	Operate (down)	0
					Release	Battery voltage
12 (R/L)	Ground	Sensor power supply	Output	—	—	Battery voltage
17 (P)	—	CAN-L	—	—	—	—
18 (O)	Ground	Sliding sensor signal	Input	Seat sliding	Operate	
					Stop	
19 (W)	Ground	Lifting sensor (front) signal	Input	Seat lifting (front)	Operate	
					Stop	

A  
B  
C  
D  
E  
F  
G  
H  
I  
J  
K  
L  
M  
N  
O  
P

ADP

# DRIVER SEAT CONTROL UNIT

## < ECU DIAGNOSIS >

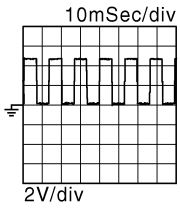
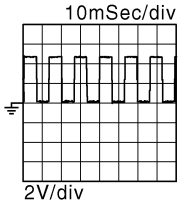
Terminal No. (wire color)		Description		Condition		Voltage (V) (Approx)
+	-	Signal name	Input/ Output			
20 (G)	Ground	Lifting sensor (rear) signal	Input	Seat lifting (rear)	Operate	 <small>10mSec/div</small> <small>2V/div</small>
					Stop	0 or 5
21 (L/R)	Ground	Tilt sensor signal	Input	Tilt	Operate	 <small>10mSec/div</small> <small>2V/div</small>
					Other than above	0 or 5
22 (V/W)	Ground	Memory switch 1 signal	Input	Memory switch 1	Press	0
					Other than above	5
23 (W/Y)	Ground	Memory indicator 1 signal	Output	Memory indicator 1	Illuminate	1
					Other than above	Battery voltage
24 (Y)	Ground	Sliding switch forward signal	Input	Sliding switch	Operate (forward)	0
					Release	Battery voltage
25 (GR)	Ground	Reclining switch forward signal	Input	Reclining switch	Operate (forward)	0
					Release	Battery voltage
26 (O)	Ground	Lifting switch (front) up signal	Input	Seat lifting switch (front)	Operate (up)	0
					Release	Battery voltage
27 (R)	Ground	Lifting switch (rear) up signal	Input	Seat lifting switch (rear)	Operate (up)	0
					Release	Battery voltage
28 (P/B)	Ground	Set switch signal	Input	Set switch	Press	0
					Other than above	5
33 (R/Y)	Ground	Power source	Input	—		Battery voltage
34 (V)	Ground	Sliding motor backward output signal	Output	Seat sliding	Operate (backward)	Battery voltage
					Stop	0
35 (GR)	Ground	Reclining motor forward output signal	Output	Seat reclining	Operate (forward)	Battery voltage
					Release	0
36 (L/G)	Ground	Lifting motor (front) down output signal	Output	Seat lifting (front)	Operate (down)	Battery voltage
					Stop	0

# DRIVER SEAT CONTROL UNIT

## < ECU DIAGNOSIS >

Terminal No. (wire color)		Description		Condition	Voltage (V) (Approx)	
+	-	Signal name	Input/ Output			
38 (Y)	Ground	Sliding motor forward out- put signal	Output	Seat sliding	Operate (forward)  Release	Battery voltage  0
				Seat reclining	Operate (backward)  Stop	Battery voltage  0
40 (O)	Ground	Lifting motor (front) up out- put signal	Output	Seat lifting (front)	Operate (up)  Stop	Battery voltage  0
				Seat lifting (rear)	Operate (up)  Stop	Battery voltage  0
41 (R)	Ground	Lifting motor (rear) up out- put signal	Output	Seat lifting (rear)	Operate (up)  Stop	Battery voltage  0
				Seat lifting (rear)	Operate (down)  Stop	Battery voltage  0
42 (B)	Ground	Lifting motor (rear) down output signal	Output	—	—	0
43 (B)	Ground	Ground (power)	—	—	—	0

A  
B  
C  
D  
E  
F  
G  
H  
I  
K  
L  
M  
N  
O  
P

ADP

# DRIVER SEAT CONTROL UNIT

< ECU DIAGNOSIS >

## Wiring Diagram

INFOID:000000004363684

### AUTOMATIC DRIVE POSITIONER

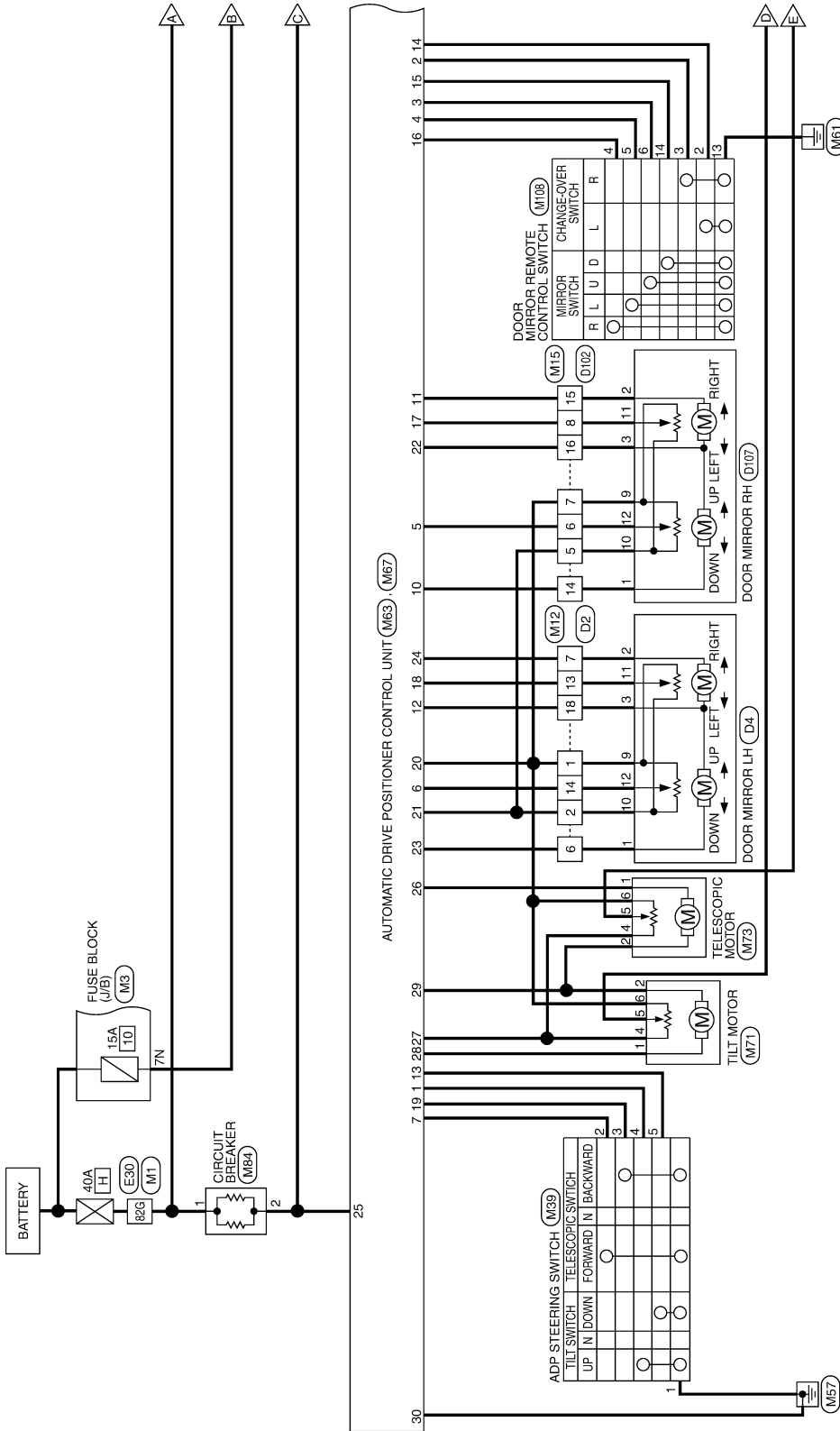

ABJWA0052GB

# DRIVER SEAT CONTROL UNIT

< ECU DIAGNOSIS >

◁LM▷: WITH POWER LUMBAR SUPPORT

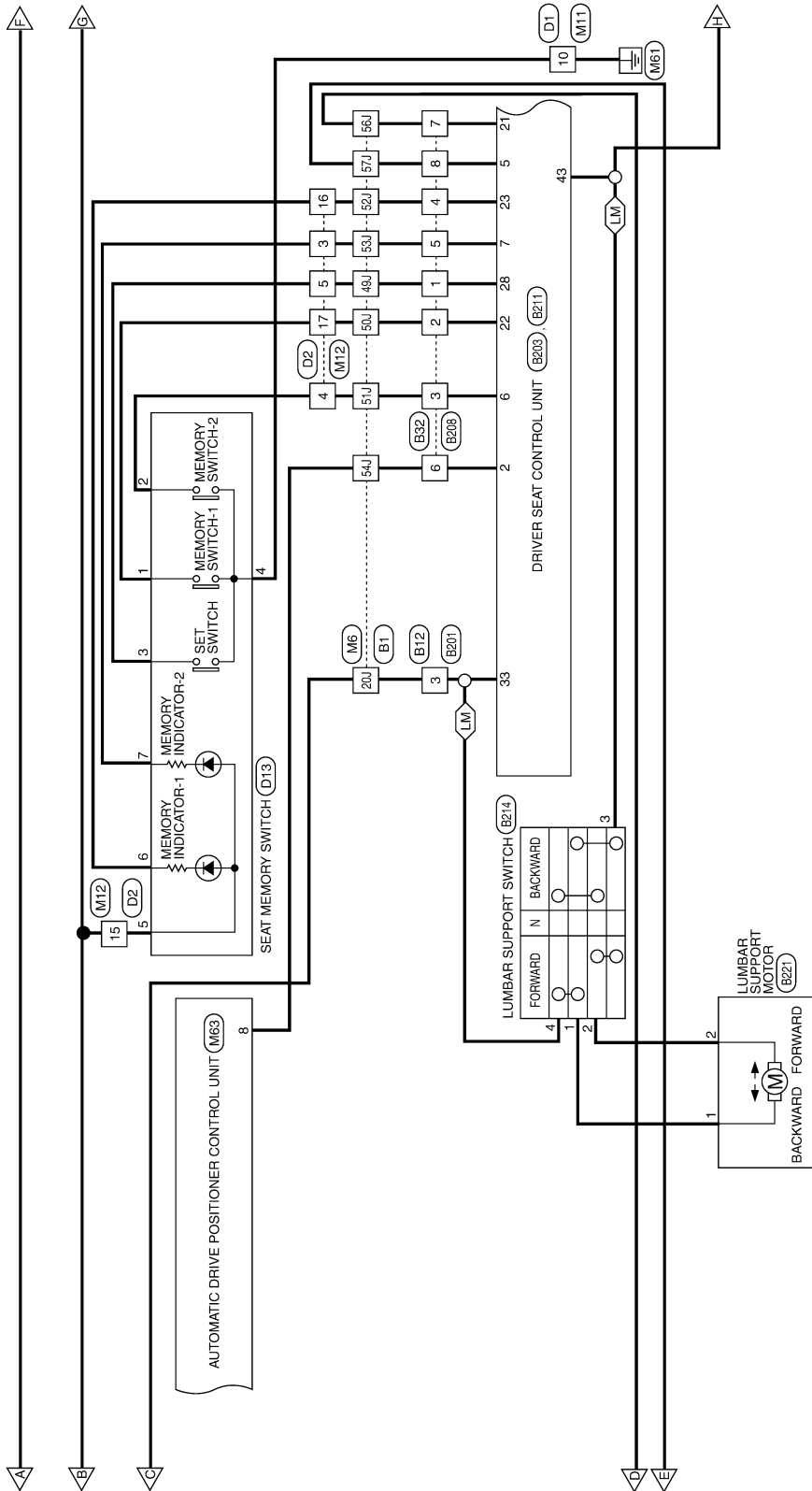

A  
B  
C  
D  
E  
F  
G  
H  
I  
ADP  
K  
L  
M  
N  
O  
P

ABJWA0053GB





# DRIVER SEAT CONTROL UNIT

< ECU DIAGNOSIS >

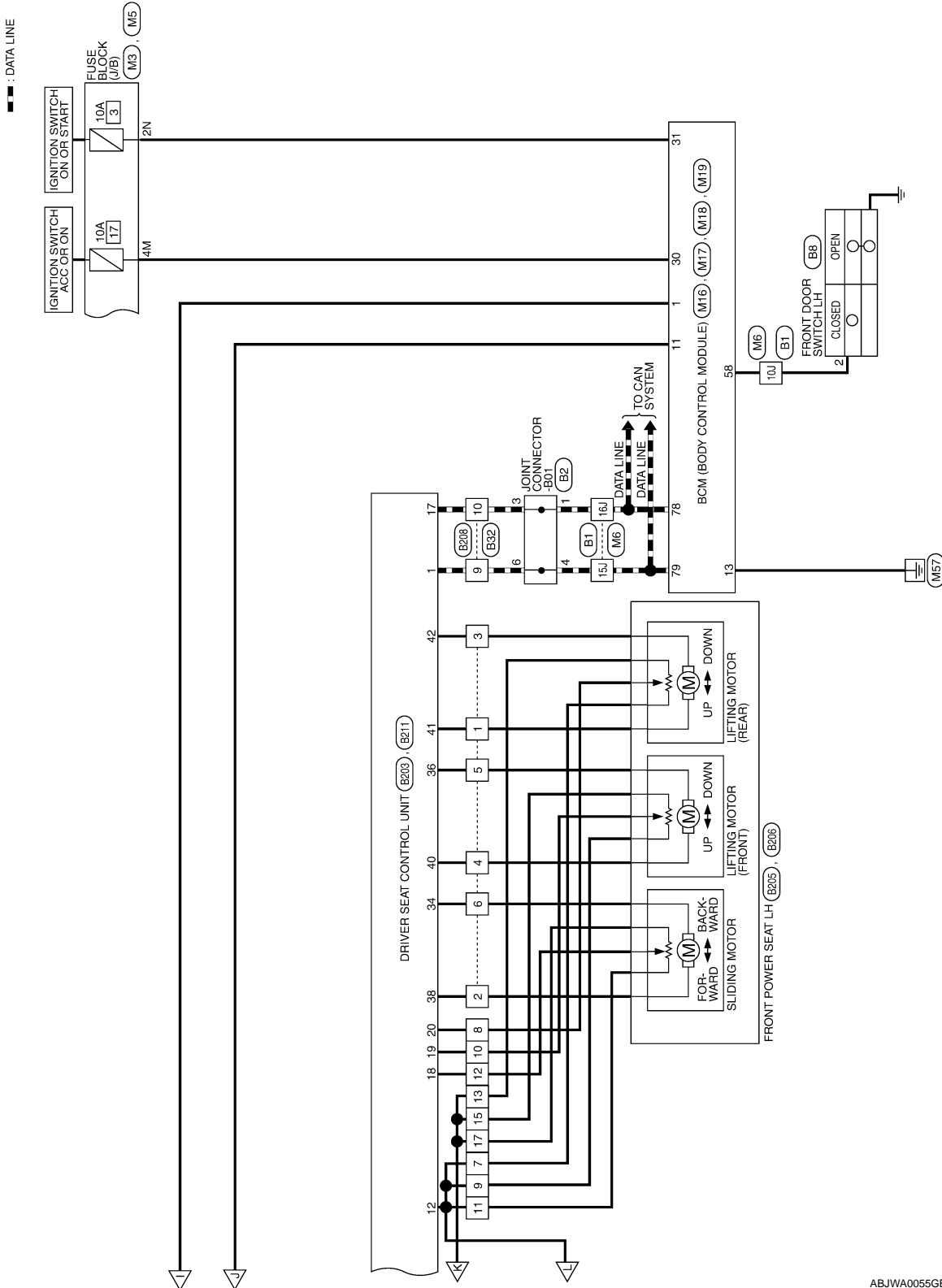

ABJWA0055GB

A  
B  
C  
D  
E  
F  
G  
H  
I  
K  
L  
M  
N  
O  
P

ADP

# DRIVER SEAT CONTROL UNIT

< ECU DIAGNOSIS >

## AUTOMATIC DRIVE POSITIONER CONNECTORS

Connector No.	M1
Connector Name	WIRE TO WIRE
Connector Color	WHITE

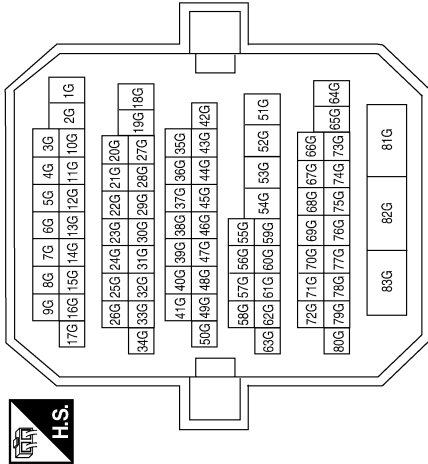

Terminal No.	Color of Wire	Signal Name
82G	W/B	-

Connector No.	M3
Connector Name	FUSE BLOCK (J/B)
Connector Color	WHITE

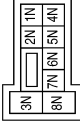

Terminal No.	Color of Wire	Signal Name
2N	G	-
7N	Y/R	-

Connector No.	M5
Connector Name	FUSE BLOCK (J/B)
Connector Color	WHITE



Terminal No.	Color of Wire	Signal Name
4M	V/Y	-

ABJIA0165GB

# DRIVER SEAT CONTROL UNIT

< ECU DIAGNOSIS >

Connector No.	M11
Connector Name	WIRE TO WIRE
Connector Color	WHITE

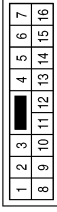

Terminal No.	Color of Wire	Signal Name
10	B	-

Terminal No.	Color of Wire	Signal Name
10J	SB	-
15J	L	-
16J	P	-
20J	R/Y	-
49J	LG	-
50J	GR	-
51J	SB	-
52J	O	-
53J	Y	-
54J	R	-
56J	V	-
57J	R	-

Connector No.	M6
Connector Name	WIRE TO WIRE
Connector Color	WHITE

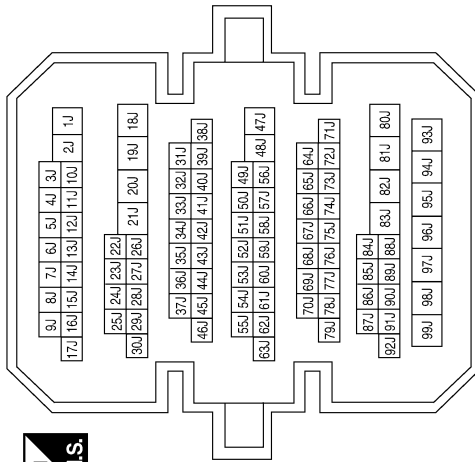

Connector No.	M15
Connector Name	WIRE TO WIRE
Connector Color	WHITE

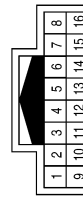

Terminal No.	Color of Wire	Signal Name
5	BR	-
6	GR	-
7	P	-
8	L	-
14	G	-
15	V	-
16	Y	-

Terminal No.	Color of Wire	Signal Name
7	V	-
12	R/L	-
13	L	-
14	W	-
15	Y/R	-
16	O	-
17	GR	-
18	Y	-

Connector No.	M12
Connector Name	WIRE TO WIRE
Connector Color	WHITE



Terminal No.	Color of Wire	Signal Name
1	P	-
2	BR	-
3	Y	-
4	SB	-
5	LG	-
6	GR	-

ABJIA0166GB

A  
B  
C  
D  
E  
F  
G  
H  
I  
ADP  
K  
L  
M  
N  
O  
P

# DRIVER SEAT CONTROL UNIT

< ECU DIAGNOSIS >

Connector No.	M16
Connector Name	BCM (BODY CONTROL MODULE)
Connector Color	BLACK



Terminal No.	Color of Wire	Signal Name
1	W/B	BAT POWER F/L

Connector No.	M17
Connector Name	BCM (BODY CONTROL MODULE)
Connector Color	WHITE

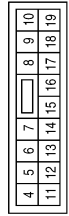

Terminal No.	Color of Wire	Signal Name
11	Y/R	BAT BCM FUSE
13	B	GND1

Connector No.	M18
Connector Name	BCM (BODY CONTROL MODULE)
Connector Color	GREEN



38	37	36	35	34	33	32	31	30	29	28	27	26	25	24	23	22	21	20	
59	58	57	56	55	54	53	52	51	50	49	48	47	46	45	44	43	42	41	40

Terminal No.	Color of Wire	Signal Name
30	V/Y	ACC F/B
31	G	IGN F/B
58	SB	DR DOOR SW

Connector No.	M19
Connector Name	BCM (BODY CONTROL MODULE)
Connector Color	BLACK



79	78	77	76	75	74	73	72	71	70	69	68	67	66	65	64	63	62	61	60
99	98	97	96	95	94	93	92	91	90	89	88	87	86	85	84	83	82	81	80

Terminal No.	Color of Wire	Signal Name
78	P	CAN-L
79	L	CAN-H

Connector No.	M39
Connector Name	ADP STEERING SWITCH
Connector Color	GRAY



Terminal No.	Color of Wire	Signal Name
1	B	-
2	P	-
3	G	-
4	Y	-
5	LG	-

ABJIA0167GB

# DRIVER SEAT CONTROL UNIT

< ECU DIAGNOSIS >

Terminal No.	Color of Wire	Signal Name
17	L	MIR SENS LEFT AND RIGHT RH
18	L	MIR SENS LEFT AND RIGHT LH
19	G	BACKWARD
20	P	SENS GND
21	BR	SENS PWR
22	Y	MIR MTR CMN RH
23	GR	MIR MTR UP DOWN LH
24	V	MIR MOTOR LEFT AND RIGHT LH

Terminal No.	Color of Wire	Signal Name
6	W	MIR SENS UP DOWN LH
7	P	FORWARD
8	R	UART
9	-	-
10	G	MIR MTR UP DOWN RH
11	V	MIR MTR LEFT AND RIGHT RH
12	Y	MIR MTR CMN LH
13	LG	DOWNWARD
14	O	SELECT LH
15	L/B	DOWNWARD
16	V	RIGHTWARD

Connector No.	M63
Connector Name	AUTOMATIC DRIVE POSITIONER CONTROL UNIT
Connector Color	WHITE

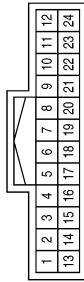

Terminal No.	Color of Wire	Signal Name
1	Y	UPWARD
2	V/W	SELECT RH
3	Y/B	UPWARD
4	V/W	LEFTWARD
5	GR	MIR SENS UP DOWN RH

Connector No.	M73
Connector Name	TELESCOPIC MOTOR
Connector Color	WHITE

Connector No.	M71
Connector Name	TILT MOTOR
Connector Color	WHITE

Connector No.	M67
Connector Name	AUTOMATIC DRIVE POSITIONER CONTROL UNIT
Connector Color	WHITE

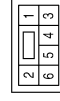

Terminal No.	Color of Wire	Signal Name
1	V	-
2	W/B	-
4	L	-
5	R	-
6	P	-

Terminal No.	Color of Wire	Signal Name
1	G	-
2	W/B	-
4	L	-
5	V	-
6	P	-

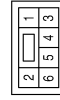

Terminal No.	Color of Wire	Signal Name
25	R/Y	BAT
26	V	BACKWARD
27	L	STRG SENS VCC
28	G	DOWNWARD
29	W/B	UPWARD/FORWARD
30	B	GND

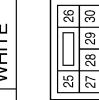

ABJIA0168GB

A  
B  
C  
D  
E  
F  
G  
H  
I  
ADP  
K  
L  
M  
N  
O  
P

# DRIVER SEAT CONTROL UNIT

< ECU DIAGNOSIS >

Terminal No.	Color of Wire	Signal Name
14	L/B	-

Connector No.	M108
Connector Name	DOOR MIRROR REMOTE CONTROL SWITCH (WITH AUTOMATIC DRIVE POSITIONER)
Connector Color	BROWN

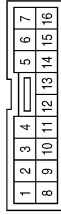

Terminal No.	Color of Wire	Signal Name
2	O	-
3	V/W	-
4	V	-
5	V/W	-
6	Y/B	-
13	B	-

Connector No.	M84
Connector Name	CIRCUIT BREAKER
Connector Color	WHITE



Terminal No.	Color of Wire	Signal Name
1	W/B	-
2	R/Y	-

Terminal No.	Color of Wire	Signal Name
82G	LG	-

Connector No.	E30
Connector Name	WIRE TO WIRE
Connector Color	WHITE

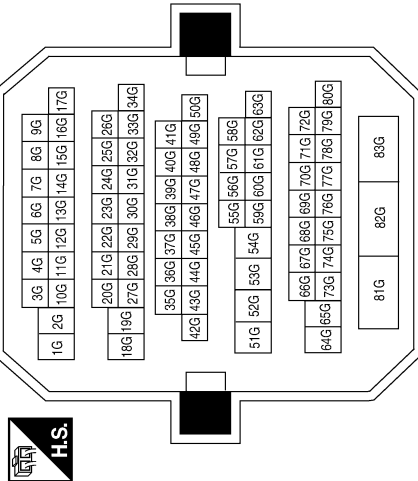

ABJIA0169GB

# DRIVER SEAT CONTROL UNIT

< ECU DIAGNOSIS >

Connector No.	B1
Connector Name	WIRE TO WIRE
Connector Color	WHITE

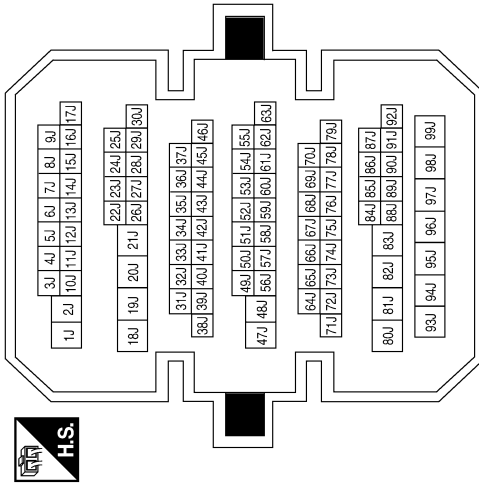

Terminal No.	Color of Wire	Signal Name
10J	SB	-
15J	L	-
16J	P	-
20J	BR	-
49J	W	-
50J	V	-
51J	BR	-
52J	SB	-
53J	LG	-
54J	P	-
56J	Y	-
57J	R	-

Connector No.	B2
Connector Name	JOINT CONNECTOR-B01
Connector Color	BLACK



Terminal No.	Color of Wire	Signal Name
1	P	-
3	P	-
4	L	-
6	L	-

Connector No.	B8
Connector Name	FRONT DOOR SWITCH LH
Connector Color	WHITE



Terminal No.	Color of Wire	Signal Name
2	SB	-

Connector No.	B12
Connector Name	WIRE TO WIRE
Connector Color	WHITE



Terminal No.	Color of Wire	Signal Name
3	BR	-
4	B/R	-(WITH AUTOMATIC DRIVE POSITIONER)

A  
B  
C  
D  
E  
F  
G  
H  
I  
ADP  
K  
L  
M  
N  
O  
P

# DRIVER SEAT CONTROL UNIT

< ECU DIAGNOSIS >

Connector No.	B201
Connector Name	WIRE TO WIRE
Connector Color	WHITE

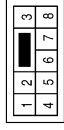

Terminal No.	Color of Wire	Signal Name
3	R/Y	-
4	B	-

Terminal No.	Color of Wire	Signal Name
1	W	-
2	V	-
3	BR	-
4	SB	-
5	LG	-
6	P	-
7	Y	-
8	R	-
9	L	-
10	P	-

Connector No.	B32
Connector Name	WIRE TO WIRE
Connector Color	WHITE

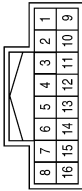

Connector No.	B203
Connector Name	DRIVER SEAT CONTROL UNIT
Connector Color	WHITE

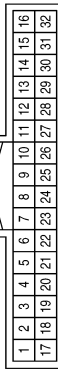

Terminal No.	Color of Wire	Signal Name
1	L	CAN-H
2	Y/L	UART TX/RX
3	-	-
4	W	PULSE RECLINER
5	P/Y	PULSE TELESCOPIC
6	O/B	ADDRESS 2

Terminal No.	Color of Wire	Signal Name
19	W	PULSE FRONT LIFTER
20	G	PULSE REAR LIFTER
21	L/R	PULSE TILT
22	V/W	ADDRESS 1
23	W/Y	IND 1
24	Y	SLIDE SW FORWARD
25	GR	RECLINER SW FORWARD
26	O	FRONT LIFTER SW UPWARD
27	R	REAR LIFTER SW UPWARD
28	P/B	SET SW
29	-	-
30	-	-
31	-	-
32	-	-

Terminal No.	Color of Wire	Signal Name
7	SB	IND 2
8	V	SLIDE SW BACKWARD
9	V	RECLINER SW BACKWARD
10	L	FRONT LIFTER SW DOWNWARD
11	B	REAR LIFTER SW DOWNWARD
12	R/L	POWER SUPPLY ENCODER
13	-	-
14	-	-
15	-	-
16	-	-
17	P	CAN-L
18	O	PULSE SLIDE

ABJIA0171GB



# DRIVER SEAT CONTROL UNIT

< ECU DIAGNOSIS >

Terminal No.	Color of Wire	Signal Name
13	B	-
14	-	-
15	B	-
16	-	-
17	B	-
18	-	-

Connector No.	B206
Connector Name	FRONT POWER SEAT LH (WITH AUTOMATIC DRIVE POSITIONER)
Connector Color	WHITE

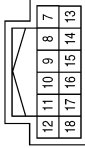

Terminal No.	Color of Wire	Signal Name
7	R/L	-
8	G	-
9	R/B	-
10	W	-
11	R	-
12	O	-

Connector No.	B205
Connector Name	FRONT POWER SEAT LH (WITH AUTOMATIC DRIVE POSITIONER)
Connector Color	WHITE

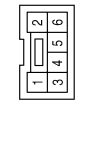

Terminal No.	Color of Wire	Signal Name
1	R	-
2	Y	-
3	B	-
4	O	-
5	L/G	-
6	V	-

Terminal No.	Color of Wire	Signal Name
37	-	-
38	Y	SLIDE MOTOR FORWARD
39	W	RECLINER MOTOR BACKWARD
40	O	FRONT LIFTER MOTOR UPWARD
41	R	REAR LIFTER MOTOR UPWARD
42	B	REAR LIFTER MOTOR DOWNWARD
43	B	GND
44	-	-

Connector No.	B211
Connector Name	DRIVER SEAT CONTROL UNIT
Connector Color	WHITE

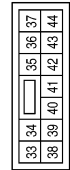

Terminal No.	Color of Wire	Signal Name
33	R/Y	BAT (PTC)
34	V	SLIDE MOTOR BACKWARD
35	GR	RECLINER MOTOR FORWARD
36	L/G	FRONT LIFTER MOTOR DOWNWARD

Connector No.	B208
Connector Name	WIRE TO WIRE
Connector Color	WHITE



Terminal No.	Color of Wire	Signal Name
1	W	-
2	V	-
3	BR	-
4	SB	-
5	LG	-
6	P	-
7	Y	-
8	R	-
9	L	-
10	P	-

ABJIA0172GB

A  
B  
C  
D  
E  
F  
G  
H  
I  
K  
L  
M  
N  
O  
P

ADP

# DRIVER SEAT CONTROL UNIT

< ECU DIAGNOSIS >

Connector No.	B213
Connector Name	POWER SEAT SWITCH LH (WITH AUTOMATIC DRIVE POSITIONER)
Connector Color	WHITE

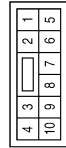

Terminal No.	Color of Wire	Signal Name
1	L	-
2	O	-
3	B	-
4	-	-
5	GR	-
6	V	-
7	Y	-
8	B	-
9	R	-
10	V	-

Connector No.	B214
Connector Name	LUMBAR SUPPORT SWITCH
Connector Color	WHITE

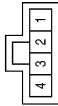

Terminal No.	Color of Wire	Signal Name
1	R/L	-
2	R/W	-
3	B	-
4	R/Y	-

Connector No.	B221
Connector Name	LUMBAR SUPPORT MOTOR
Connector Color	BLACK



Terminal No.	Color of Wire	Signal Name
1	R/L	-
2	R/W	-

Connector No.	B222
Connector Name	RECLINING MOTOR LH (WITH AUTOMATIC DRIVE POSITIONER)
Connector Color	WHITE

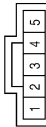

Terminal No.	Color of Wire	Signal Name
1	W	-
2	R	-
3	W	-
4	R/G	-
5	GR	-

Connector No.	D1
Connector Name	WIRE TO WIRE
Connector Color	WHITE

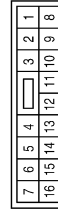

Terminal No.	Color of Wire	Signal Name
10	B	-

ABJIA0173GB

# DRIVER SEAT CONTROL UNIT

< ECU DIAGNOSIS >

Connector No.	D4
Connector Name	DOOR MIRROR LH
Connector Color	WHITE

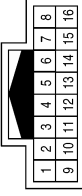

Terminal No.	Color of Wire	Signal Name
1	V	-
2	P	-
3	LG	-
9	Y	-
10	R	-
11	G	-
12	BR	-

Terminal No.	Color of Wire	Signal Name
15	GR	-
16	SB	-
17	V	-
18	LG	-

Connector No.	D2
Connector Name	WIRE TO WIRE
Connector Color	WHITE

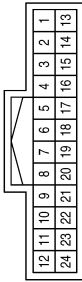

Terminal No.	Color of Wire	Signal Name
1	Y	-
2	R	-
3	LG	-
4	BR	-
5	W	-
6	V	-
7	P	-
13	G	-
14	BR	-

Connector No.	D107
Connector Name	DOOR MIRROR RH
Connector Color	WHITE

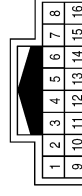

Terminal No.	Color of Wire	Signal Name
1	V	-
2	P	-
3	LG	-
9	W/B	-
10	R	-
11	G	-
12	BR	-

Connector No.	D102
Connector Name	WIRE TO WIRE
Connector Color	WHITE

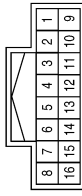

Terminal No.	Color of Wire	Signal Name
5	R	-
6	BR	-
7	W/B	-
8	G	-
14	V	-
15	P	-
16	LG	-

Connector No.	D13
Connector Name	SEAT MEMORY SWITCH
Connector Color	WHITE

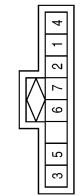

Terminal No.	Color of Wire	Signal Name
1	V	-
2	BR	-
3	W	-
4	B	-
5	GR	-
6	SB	-
7	LG	-
8	-	-

## Fail Safe

The fail-safe mode may be activated if the following symptoms are observed.

ABJIA0174GB

INFOID:000000004375811

A  
B  
C  
D  
E  
F  
G  
H  
I  
ADP  
K  
L  
M  
N  
O  
P

# DRIVER SEAT CONTROL UNIT

## < ECU DIAGNOSIS >

Operating in fail-safe mode	Malfunction Item	Related DTC	Diagnosis
Only manual functions operate normally.	CAN communication	U1000	<a href="#">ADP-37</a>
	CONTROL UNIT	U1010	<a href="#">ADP-38</a>
	EEPROM	B2130	<a href="#">ADP-39</a>
Only manual functions, except door mirror, operate normally.	UART communication	B2128	<a href="#">ADP-43</a>
Only manual functions, except seat sliding, operate normally.	Seat sliding output	B2112	<a href="#">ADP-40</a>
Only manual functions, except seat reclining, operate normally.	Seat reclining output	B2113	<a href="#">ADP-41</a>
Only manual functions, except steering tilt, operate normally.	Steering column tilt output	B2116	<a href="#">ADP-42</a>

## DTC Index

INFOID:000000004375812

CONSULT-III display	Timing <sup>*1</sup>		Item	Reference page
	Current malfunction	Previous malfunction		
CAN COMM CIRCUIT [U1000]	0	1-39	CAN communication	<a href="#">ADP-37</a>
CONTROL UNIT [U1010]	0	1-39	Control unit	<a href="#">ADP-38</a>
SEAT SLIDE [B2112]	0	1-39	Seat slide motor output	<a href="#">ADP-40</a>
SEAT RECLINING [B2113]	0	1-39	Seat reclining motor output	<a href="#">ADP-41</a>
STEERING TILT [B2116]	0	1-39	Tilt motor output	<a href="#">ADP-42</a>
UART COMM [B2128]	0	1-39	UART communication	<a href="#">ADP-43</a>
EEPROM [B2130]	0	1-39	EEPROM	<a href="#">ADP-39</a>

\*1:

- 0: Current malfunction is present
- 1-39: Displayed if any previous malfunction is present when current condition is normal. The numeral value increases by one at each IGN ON to OFF cycle from 1 to 39. The counter remains at 39 even if the number of cycles exceeds it. However, the counter is reset to 1 if any malfunction is detected again, the normal operation is resumed and the ignition switch is turned from OFF to ON.

# AUTOMATIC DRIVE POSITIONER CONTROL UNIT

< ECU DIAGNOSIS >

## AUTOMATIC DRIVE POSITIONER CONTROL UNIT

Reference Value

INFOID:000000003900384

### TERMINAL LAYOUT

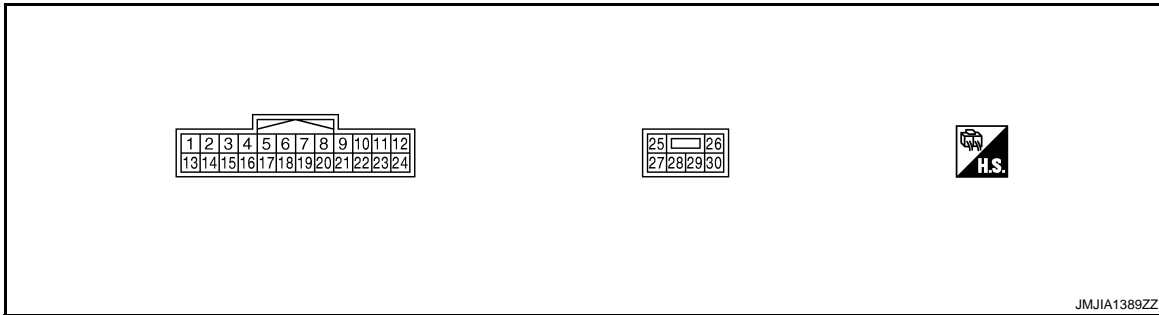

### PHYSICAL VALUES

Terminal No. (wire color)		Description		Condition		Voltage (V) (Approx.)
+	-	Signal name	Input/ Output			
1 (Y)	Ground	Tilt switch up signal	Input	Tilt switch	Operate (up)	0
					Other than above	5
2 (V/W)	Ground	Changeover switch RH signal	Input	Changeover switch position	RH	0
					Neutral or LH	5
3 (Y/B)	Ground	Mirror switch up signal	Input	Mirror switch	Operated (up)	0
					Other than above	5
4 (V/W)	Ground	Mirror switch left signal	Input	Mirror switch	Operated (left)	0
					Other than above	5
5 (GR)	Ground	Door mirror sensor (passenger side) up/down signal	Input	Door mirror RH position	Change between 3.4 (close to peak) 0.6 (close to valley)	
6 (W)	Ground	Door mirror sensor (driver side) up/down signal	Input	Door mirror LH position	Change between 3.4 (close to peak) 0.6 (close to valley)	
7 (P)	Ground	Telescopic switch forward signal	Input	Telescopic switch	Operate (forward)	0
					Other than above	5
8 (R)	Ground	UART communication (TX/RX)	Output	Ignition switch ON		

A  
B  
C  
D  
E  
F  
G  
H  
I  
K  
L  
M  
N  
O  
P

ADP

# AUTOMATIC DRIVE POSITIONER CONTROL UNIT

## < ECU DIAGNOSIS >

Terminal No. (wire color)		Description		Condition		Voltage (V) (Approx.)
+	-	Signal name	Input/ Output			
10 (G)	Ground	Door mirror motor (passenger side) up output signal	Output	Door mirror RH	Operate (up)	Battery voltage
					Other than above	0
11 (V)	Ground	Door mirror motor (passenger side) left output signal	Output	Door mirror RH	Operate (left)	Battery voltage
					Other than above	0
12 (Y)	Ground	Door mirror motor (driver side) down output signal	Output	Door mirror (LH)	Operate (down)	Battery voltage
					Other than above	0
		Door mirror motor (driver side) right output signal			Operate (right)	Battery voltage
					Other than above	0
13 (LG)	Ground	Tilt switch down signal	Input	Tilt switch	Operate (down)	0
					Other than above	5
14 (O)	Ground	Changeover switch LH signal	Input	Changeover switch position	LH	0
					Neutral or RH	5
15 (L/B)	Ground	Mirror switch down signal	Input	Mirror switch	Operate (down)	0
					Other than above	5
16 (V)	Ground	Mirror switch right signal	Input	Mirror switch	Operate (right)	0
					Other than above	5
17 (L)	Ground	Door mirror sensor (passenger side) left/right signal	Input	Door mirror RH position		Change between 3.4 (close to left edge) 0.6 (close to right edge)
18 (L)	Ground	Door mirror sensor (driver side) left/right signal	Input	Door mirror LH position		Change between 0.6 (close to left edge) 3.4 (close to right edge)
19 (G)	Ground	Telescopic switch backward signal	Input	Telescopic switch	Operate (backward)	0
					Other than above	5
20 (P)	Ground	Ground	—	—		0
21 (BR)	Ground	Door mirror motor sensor power supply	Input	—		5

# AUTOMATIC DRIVE POSITIONER CONTROL UNIT

## < ECU DIAGNOSIS >

Terminal No. (wire color)		Description		Condition	Voltage (V) (Approx.)	
+	-	Signal name	Input/ Output			
22 (Y)	Ground	Door mirror motor (passenger side) down output signal	Output	Door mirror (RH)	Operate (down)	Battery voltage
					Other than above	0
		Door mirror motor (passenger side) right output signal			Operate (right)	Battery voltage
					Other than above	0
23 (GR)	Ground	Door mirror motor (driver side)up output signal	Output	Door mirror (LH)	Operate (up)	Battery voltage
					Other than above	0
24 (V)	Ground	Door mirror motor (driver side)left output signal	Output	Door mirror (LH)	Operate (left)	Battery voltage
					Other than above	0
25 (R/Y)	Ground	Power source	Input	—	Battery voltage	
26 (V)	Ground	Telescopic motor backward output signal	Output	Steering telescopic	Operate (backward)	Battery voltage
					Other than above	0
27 (L)	Ground	Tilt&telescopic motor power source		—	Battery voltage	
28 (G)	Ground	Tilt motor down output signal	Output	Steering tilt	Operate (down)	Battery voltage
					Other than above	0
29 (W/B)	Ground	Tilt motor up output signal	Output	Steering tilt	Operate (up)	Battery voltage
					Other than above	0
		Telescopic motor forward output signal		Steering telescopic	Operate (forward)	Battery voltage
					Other than above	0
30 (B)	Ground	Ground	—	—	0	

A  
B  
C  
D  
E  
F  
G  
H  
I  
ADP  
K  
L  
M  
N  
O  
P

# AUTOMATIC DRIVE POSITIONER CONTROL UNIT

< ECU DIAGNOSIS >

## Wiring Diagram

INFOID:000000003900385

### AUTOMATIC DRIVE POSITIONER

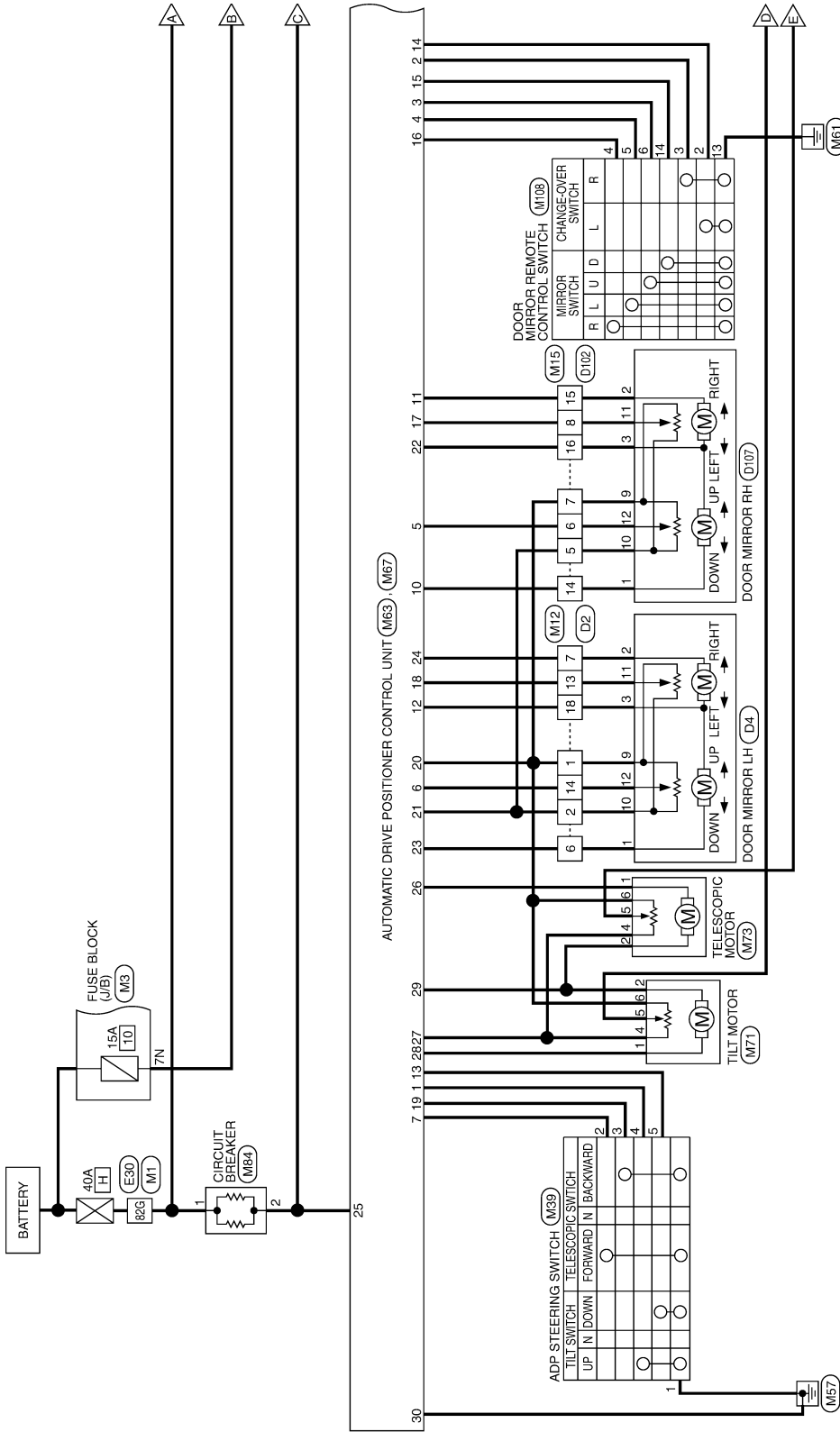

ABJWA0052GB



# AUTOMATIC DRIVE POSITIONER CONTROL UNIT

< ECU DIAGNOSIS >

◀LM▶: WITH POWER LUMBAR SUPPORT

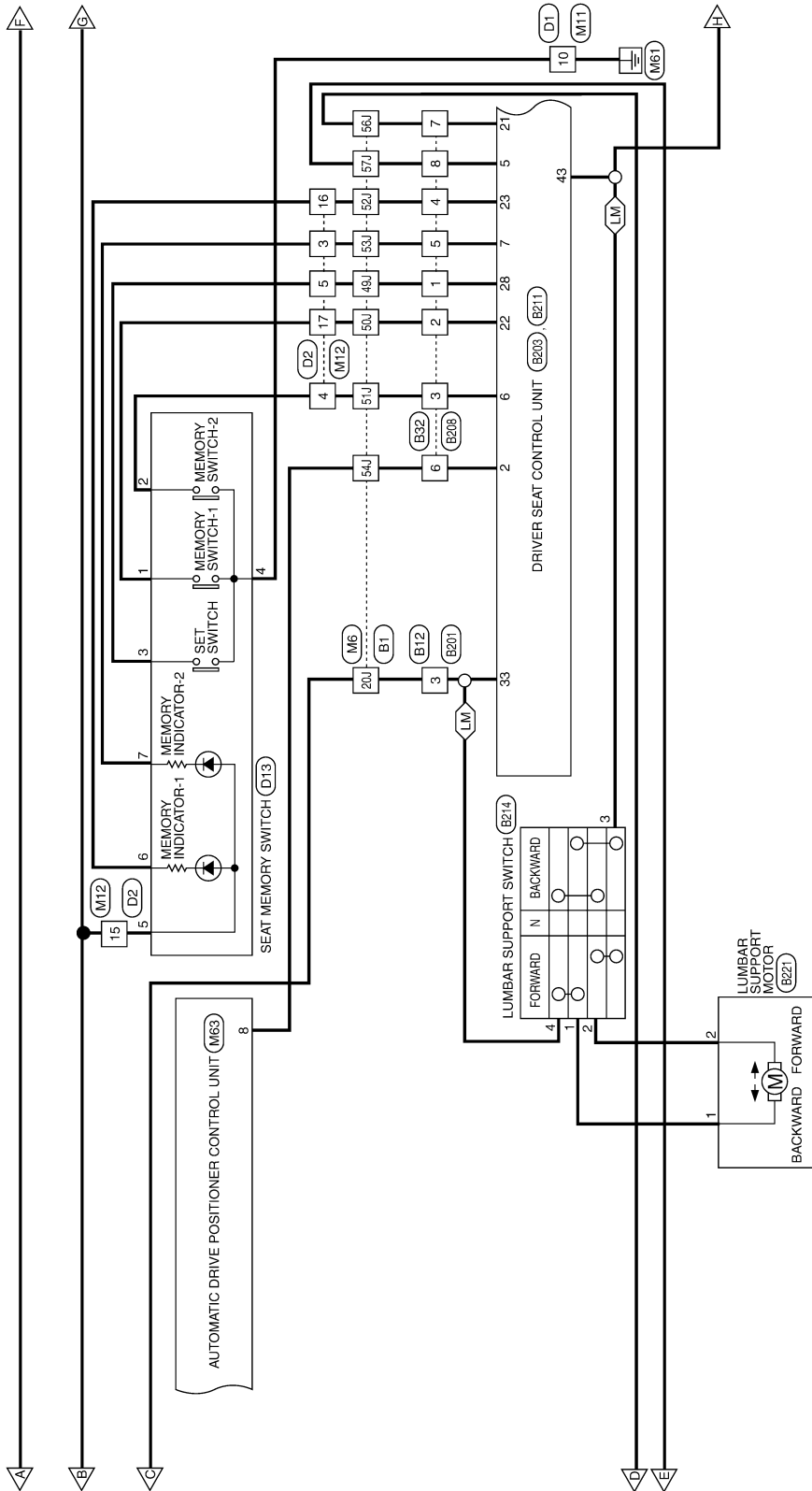

ABJWA0053GB

A  
B  
C  
D  
E  
F  
G  
H  
I  
ADP  
K  
L  
M  
N  
O  
P

# AUTOMATIC DRIVE POSITIONER CONTROL UNIT

< ECU DIAGNOSIS >

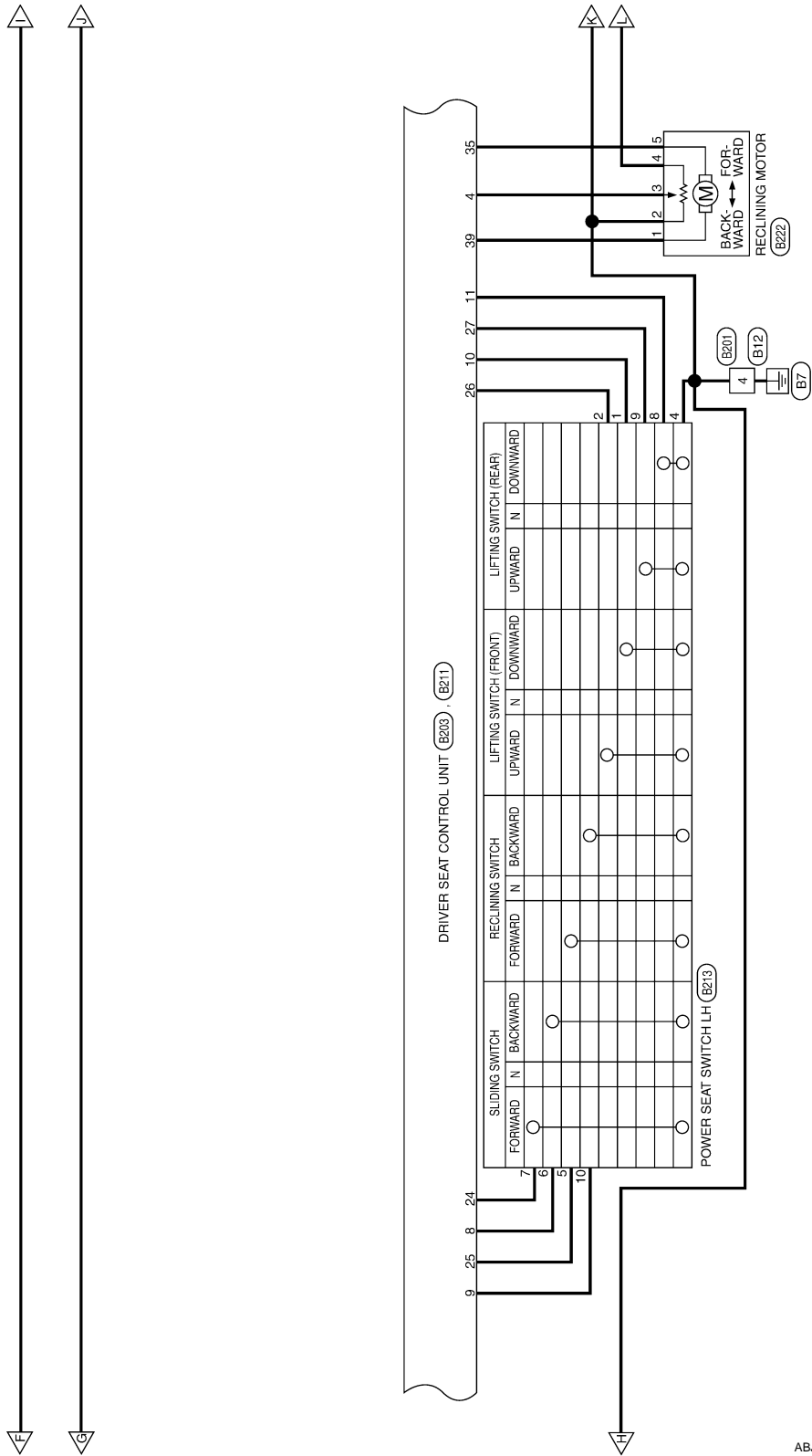

ABJWA0054GB

# AUTOMATIC DRIVE POSITIONER CONTROL UNIT

< ECU DIAGNOSIS >

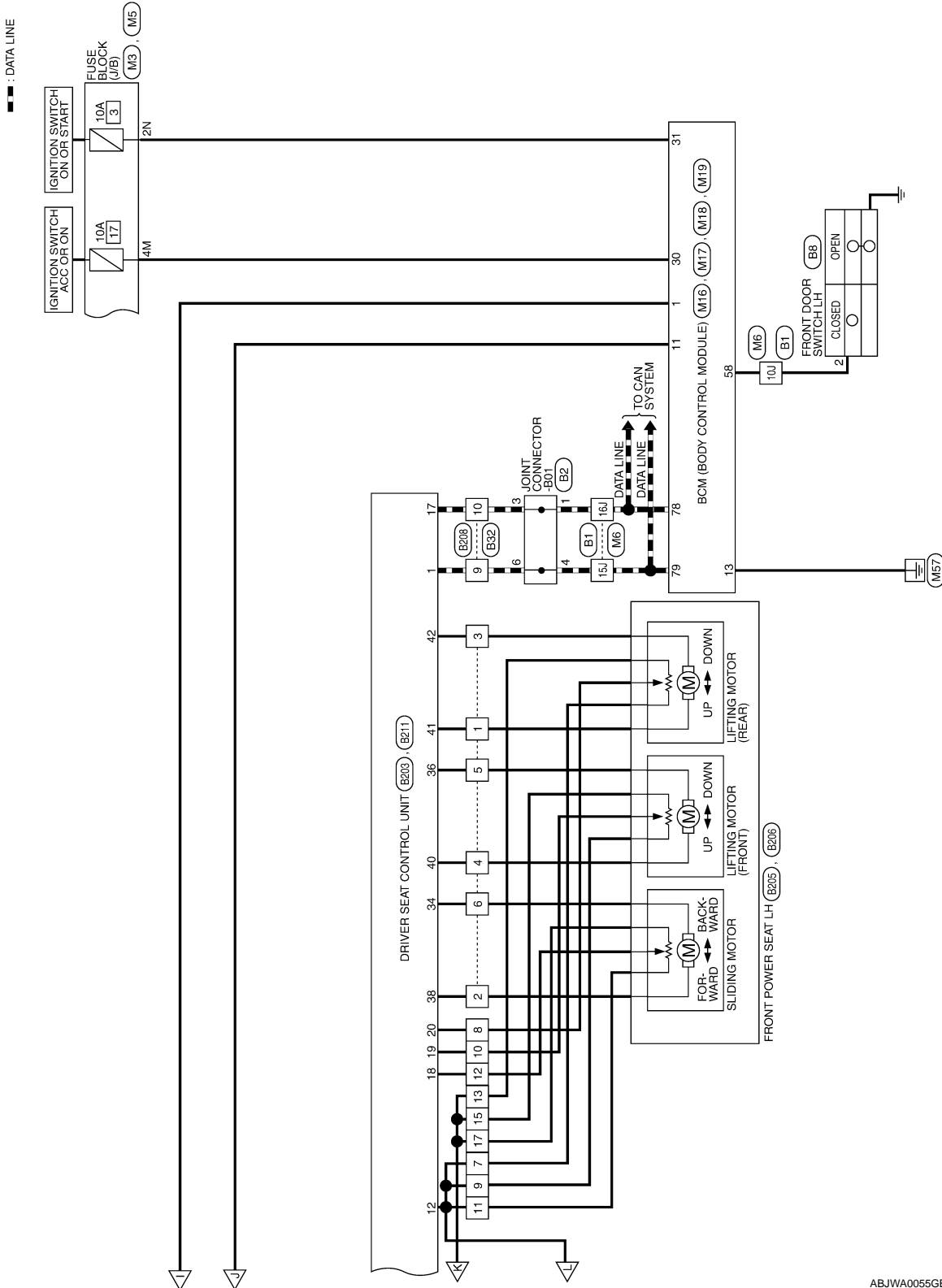

A  
B  
C  
D  
E  
F  
G  
H  
I  
K  
L  
M  
N  
O  
P

ADP

ABJWA0055GB

# AUTOMATIC DRIVE POSITIONER CONTROL UNIT

< ECU DIAGNOSIS >

## AUTOMATIC DRIVE POSITIONER CONNECTORS

Connector No.	M1
Connector Name	WIRE TO WIRE
Connector Color	WHITE

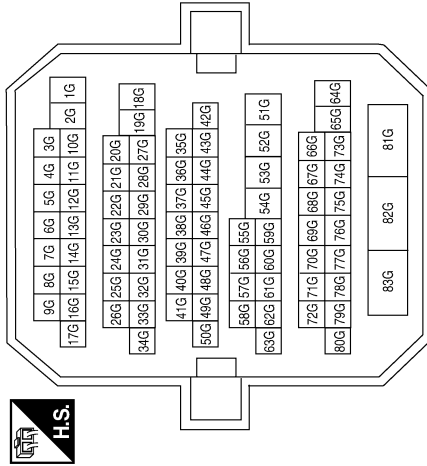

Terminal No.	Color of Wire	Signal Name
82G	W/B	-

Connector No.	M3
Connector Name	FUSE BLOCK (J/B)
Connector Color	WHITE

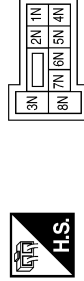

Terminal No.	Color of Wire	Signal Name
2N	G	-
7N	Y/R	-

Connector No.	M5
Connector Name	FUSE BLOCK (J/B)
Connector Color	WHITE



Terminal No.	Color of Wire	Signal Name
4M	V/Y	-

ABJIA0165GB

# AUTOMATIC DRIVE POSITIONER CONTROL UNIT

< ECU DIAGNOSIS >

Connector No.	M11
Connector Name	WIRE TO WIRE
Connector Color	WHITE

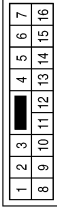

Terminal No.	Color of Wire	Signal Name
10	B	-

Terminal No.	Color of Wire	Signal Name
10J	SB	-
15J	L	-
16J	P	-
20J	R/Y	-
49J	LG	-
50J	GR	-
51J	SB	-
52J	O	-
53J	Y	-
54J	R	-
56J	V	-
57J	R	-

Connector No.	M6
Connector Name	WIRE TO WIRE
Connector Color	WHITE

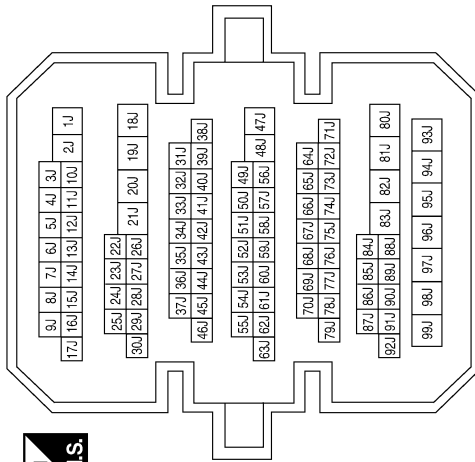

Connector No.	M15
Connector Name	WIRE TO WIRE
Connector Color	WHITE

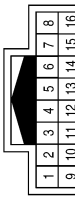

Terminal No.	Color of Wire	Signal Name
5	BR	-
6	GR	-
7	P	-
8	L	-
14	G	-
15	V	-
16	Y	-

Terminal No.	Color of Wire	Signal Name
7	V	-
12	R/L	-
13	L	-
14	W	-
15	Y/R	-
16	O	-
17	GR	-
18	Y	-

Connector No.	M12
Connector Name	WIRE TO WIRE
Connector Color	WHITE

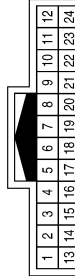

Terminal No.	Color of Wire	Signal Name
1	P	-
2	BR	-
3	Y	-
4	SB	-
5	LG	-
6	GR	-

ABJIA0166GB

A  
B  
C  
D  
E  
F  
G  
H  
I  
ADP  
K  
L  
M  
N  
O  
P

# AUTOMATIC DRIVE POSITIONER CONTROL UNIT

< ECU DIAGNOSIS >

Connector No.	M18
Connector Name	BCM (BODY CONTROL MODULE)
Connector Color	GREEN



39	38	37	36	35	34	33	32	31	30	29	28	27	26	25	24	23	22	21	20
59	58	57	56	55	54	53	52	51	50	49	48	47	46	45	44	43	42	41	40

Terminal No.	Color of Wire	Signal Name
30	V/Y	ACC F/B
31	G	IGN F/B
58	SB	DR DOOR SW

Connector No.	M17
Connector Name	BCM (BODY CONTROL MODULE)
Connector Color	WHITE



4	5	6	7	8	9	10		
11	12	13	14	15	16	17	18	19

Terminal No.	Color of Wire	Signal Name
11	Y/R	BAT BCM FUSE
13	B	GND1

Connector No.	M16
Connector Name	BCM (BODY CONTROL MODULE)
Connector Color	BLACK



1	2	3
---	---	---

Terminal No.	Color of Wire	Signal Name
1	W/B	BAT POWER F/L

Connector No.	M19
Connector Name	BCM (BODY CONTROL MODULE)
Connector Color	BLACK



79	78	77	76	75	74	73	72	71	70	69	68	67	66	65	64	63	62	61	60
99	98	97	96	95	94	93	92	91	90	89	88	87	86	85	84	83	82	81	80

Terminal No.	Color of Wire	Signal Name
78	P	CAN-L
79	L	CAN-H

Connector No.	M39
Connector Name	ADP STEERING SWITCH
Connector Color	GRAY



3	4	1	5	2
---	---	---	---	---

Terminal No.	Color of Wire	Signal Name
1	B	-
2	P	-
3	G	-
4	Y	-
5	LG	-

Connector No.	M17
Connector Name	BCM (BODY CONTROL MODULE)
Connector Color	WHITE



4	5	6	7	8	9	10		
11	12	13	14	15	16	17	18	19

Terminal No.	Color of Wire	Signal Name
11	Y/R	BAT BCM FUSE
13	B	GND1

ABJIA0167GB

# AUTOMATIC DRIVE POSITIONER CONTROL UNIT

< ECU DIAGNOSIS >

Connector No.	M63
Connector Name	AUTOMATIC DRIVE POSITIONER CONTROL UNIT
Connector Color	WHITE

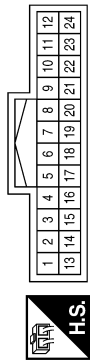

Terminal No.	Color of Wire	Signal Name
1	Y	UPWARD
2	V/W	SELECT RH
3	Y/B	UPWARD
4	V/W	LEFTWARD
5	GR	MIR SENS UP DOWN RH

Connector No.	M67
Connector Name	AUTOMATIC DRIVE POSITIONER CONTROL UNIT
Connector Color	WHITE



Terminal No.	Color of Wire	Signal Name
25	R/Y	BAT
26	V	BACKWARD
27	L	STRG SENS VCC
28	G	DOWNWARD
29	W/B	UPWARD/FORWARD
30	B	GND

Terminal No.	Color of Wire	Signal Name
6	W	MIR SENS UP DOWN LH
7	P	FORWARD
8	R	UART
9	-	-
10	G	MIR MTR UP DOWN RH
11	V	MIR MTR LEFT AND RIGHT RH
12	Y	MIR MTR CMN LH
13	LG	DOWNWARD
14	O	SELECT LH
15	L/B	DOWNWARD
16	V	RIGHTWARD

Connector No.	M71
Connector Name	TILT MOTOR
Connector Color	WHITE

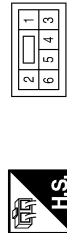

Terminal No.	Color of Wire	Signal Name
1	G	-
2	W/B	-
4	L	-
5	V	-
6	P	-

Terminal No.	Color of Wire	Signal Name
17	L	MIR SENS LEFT AND RIGHT RH
18	L	MIR SENS LEFT AND RIGHT LH
19	G	BACKWARD
20	P	SENS GND
21	BR	SENS PWR
22	Y	MIR MTR CMN RH
23	GR	MIR MTR UP DOWN LH
24	V	MIR MOTOR LEFT AND RIGHT LH

Connector No.	M73
Connector Name	TELESCOPIC MOTOR
Connector Color	WHITE

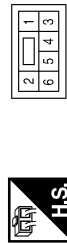

Terminal No.	Color of Wire	Signal Name
1	V	-
2	W/B	-
4	L	-
5	R	-
6	P	-

A  
B  
C  
D  
E  
F  
G  
H  
I  
ADP  
K  
L  
M  
N  
O  
P

# AUTOMATIC DRIVE POSITIONER CONTROL UNIT

< ECU DIAGNOSIS >

Terminal No.	Color of Wire	Signal Name
14	L/B	-

Connector No.	M108
Connector Name	DOOR MIRROR REMOTE CONTROL SWITCH (WITH AUTOMATIC DRIVE POSITIONER)
Connector Color	BROWN

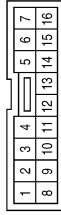

Terminal No.	Color of Wire	Signal Name
2	O	-
3	V/W	-
4	V	-
5	V/W	-
6	Y/B	-
13	B	-

Connector No.	M84
Connector Name	CIRCUIT BREAKER
Connector Color	WHITE



Terminal No.	Color of Wire	Signal Name
1	W/B	-
2	R/Y	-

Terminal No.	Color of Wire	Signal Name
82G	LG	-

Connector No.	E30
Connector Name	WIRE TO WIRE
Connector Color	WHITE

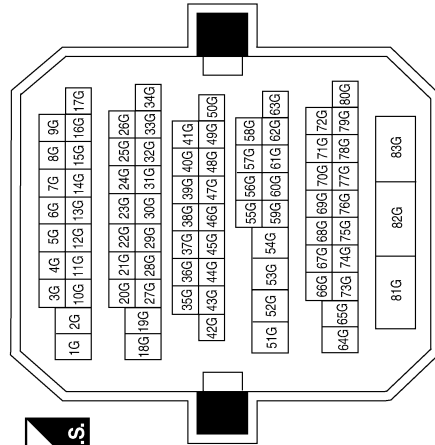

ABJIA0169GB



# AUTOMATIC DRIVE POSITIONER CONTROL UNIT

< ECU DIAGNOSIS >

Connector No.	B1
Connector Name	WIRE TO WIRE
Connector Color	WHITE

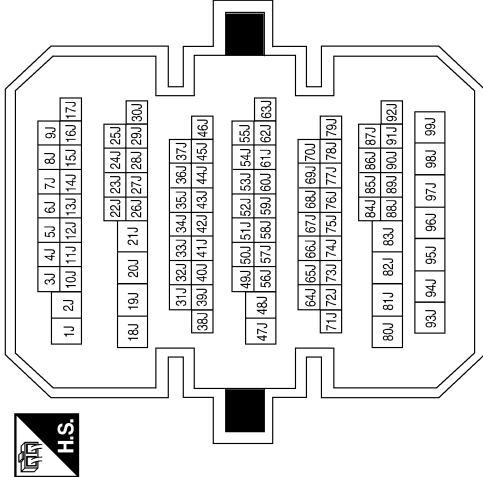

Connector No.	B8
Connector Name	FRONT DOOR SWITCH LH
Connector Color	WHITE

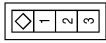

Terminal No.	Color of Wire	Signal Name
2	SB	-

Terminal No.	Color of Wire	Signal Name
10J	SB	-
15J	L	-
16J	P	-
20J	BR	-
49J	W	-
50J	V	-
51J	BR	-
52J	SB	-
53J	LG	-
54J	P	-
56J	Y	-
57J	R	-

Connector No.	B2
Connector Name	JOINT CONNECTOR-B01
Connector Color	BLACK

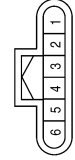

Terminal No.	Color of Wire	Signal Name
1	P	-
3	P	-
4	L	-
6	L	-

Connector No.	B12
Connector Name	WIRE TO WIRE
Connector Color	WHITE

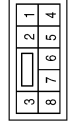

Terminal No.	Color of Wire	Signal Name
3	BR	-
4	B/R	-(WITH AUTOMATIC DRIVE POSITIONER)

A  
B  
C  
D  
E  
F  
G  
H  
I  
K  
L  
M  
N  
O  
P

ADP

# AUTOMATIC DRIVE POSITIONER CONTROL UNIT

< ECU DIAGNOSIS >

Connector No.	B201
Connector Name	WIRE TO WIRE
Connector Color	WHITE

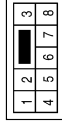

Terminal No.	Color of Wire	Signal Name
3	R/Y	-
4	B	-

Terminal No.	Color of Wire	Signal Name
1	W	-
2	V	-
3	BR	-
4	SB	-
5	LG	-
6	P	-
7	Y	-
8	R	-
9	L	-
10	P	-

Connector No.	B32
Connector Name	WIRE TO WIRE
Connector Color	WHITE

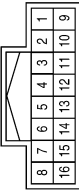

Connector No.	B203
Connector Name	DRIVER SEAT CONTROL UNIT
Connector Color	WHITE

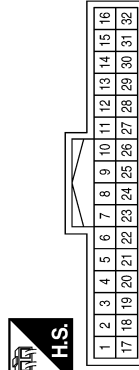

Terminal No.	Color of Wire	Signal Name
1	L	CAN-H
2	Y/L	UART TX/RX
3	-	-
4	W	PULSE RECLINER
5	P/Y	PULSE TELESCOPIC
6	O/B	ADDRESS 2

Terminal No.	Color of Wire	Signal Name
19	W	PULSE FRONT LIFTER
20	G	PULSE REAR LIFTER
21	L/R	PULSE TILT
22	V/W	ADDRESS 1
23	W/Y	IND 1
24	Y	SLIDE SW FORWARD
25	GR	RECLINER SW FORWARD
26	O	FRONT LIFTER SW UPWARD
27	R	REAR LIFTER SW UPWARD
28	P/B	SET SW
29	-	-
30	-	-
31	-	-
32	-	-

Terminal No.	Color of Wire	Signal Name
7	SB	IND 2
8	V	SLIDE SW BACKWARD
9	V	RECLINER SW BACKWARD
10	L	FRONT LIFTER SW DOWNWARD
11	B	REAR LIFTER SW DOWNWARD
12	R/L	POWER SUPPLY ENCODER
13	-	-
14	-	-
15	-	-
16	-	-
17	P	CAN-L
18	O	PULSE SLIDE

ABJIA0171GB

# AUTOMATIC DRIVE POSITIONER CONTROL UNIT

< ECU DIAGNOSIS >

Terminal No.	Color of Wire	Signal Name
13	B	-
14	-	-
15	B	-
16	-	-
17	B	-
18	-	-

Connector No.	B206
Connector Name	FRONT POWER SEAT LH (WITH AUTOMATIC DRIVE POSITIONER)
Connector Color	WHITE

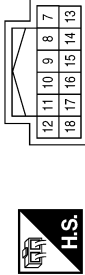

Terminal No.	Color of Wire	Signal Name
7	R/L	-
8	G	-
9	R/B	-
10	W	-
11	R	-
12	O	-

Connector No.	B205
Connector Name	FRONT POWER SEAT LH (WITH AUTOMATIC DRIVE POSITIONER)
Connector Color	WHITE

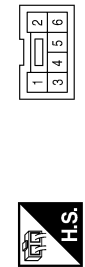

Terminal No.	Color of Wire	Signal Name
1	R	-
2	Y	-
3	B	-
4	O	-
5	L/G	-
6	V	-

Terminal No.	Color of Wire	Signal Name
37	-	-
38	Y	SLIDE MOTOR FORWARD
39	W	RECLINER MOTOR BACKWARD
40	O	FRONT LIFTER MOTOR UPWARD
41	R	REAR LIFTER MOTOR UPWARD
42	B	REAR LIFTER MOTOR DOWNWARD
43	B	GND
44	-	-

Connector No.	B211
Connector Name	DRIVER SEAT CONTROL UNIT
Connector Color	WHITE



Terminal No.	Color of Wire	Signal Name
33	R/Y	BAT (PTC)
34	V	SLIDE MOTOR BACKWARD
35	GR	RECLINER MOTOR FORWARD
36	L/G	FRONT LIFTER MOTOR DOWNWARD

Connector No.	B208
Connector Name	WIRE TO WIRE
Connector Color	WHITE

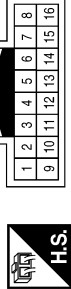

Terminal No.	Color of Wire	Signal Name
1	W	-
2	V	-
3	BR	-
4	SB	-
5	LG	-
6	P	-
7	Y	-
8	R	-
9	L	-
10	P	-

ABJIA0172GB

A  
B  
C  
D  
E  
F  
G  
H  
I  
K  
L  
M  
N  
O  
P

ADP

# AUTOMATIC DRIVE POSITIONER CONTROL UNIT

< ECU DIAGNOSIS >

Connector No.	B213
Connector Name	POWER SEAT SWITCH LH (WITH AUTOMATIC DRIVE POSITIONER)
Connector Color	WHITE

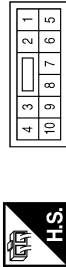

Terminal No.	Color of Wire	Signal Name
1	L	-
2	O	-
3	B	-
4	-	-
5	GR	-
6	V	-
7	Y	-
8	B	-
9	R	-
10	V	-

Connector No.	B214
Connector Name	LUMBAR SUPPORT SWITCH
Connector Color	WHITE



Terminal No.	Color of Wire	Signal Name
1	R/L	-
2	R/W	-
3	B	-
4	R/Y	-

Connector No.	B221
Connector Name	LUMBAR SUPPORT MOTOR
Connector Color	BLACK



Terminal No.	Color of Wire	Signal Name
1	R/L	-
2	R/W	-

Connector No.	B222
Connector Name	RECLINING MOTOR LH (WITH AUTOMATIC DRIVE POSITIONER)
Connector Color	WHITE



Terminal No.	Color of Wire	Signal Name
1	W	-
2	R	-
3	W	-
4	R/G	-
5	GR	-

Connector No.	D1
Connector Name	WIRE TO WIRE
Connector Color	WHITE

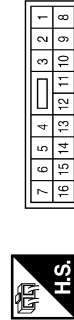

Terminal No.	Color of Wire	Signal Name
10	B	-

ABJIA0173GB

# AUTOMATIC DRIVE POSITIONER CONTROL UNIT

< ECU DIAGNOSIS >

Connector No.	D4
Connector Name	DOOR MIRROR LH
Connector Color	WHITE

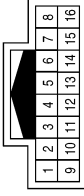

Terminal No.	Color of Wire	Signal Name
1	V	-
2	P	-
3	LG	-
9	Y	-
10	R	-
11	G	-
12	BR	-

Terminal No.	Color of Wire	Signal Name
15	GR	-
16	SB	-
17	V	-
18	LG	-

Connector No.	D2
Connector Name	WIRE TO WIRE
Connector Color	WHITE

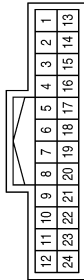

Terminal No.	Color of Wire	Signal Name
1	Y	-
2	R	-
3	LG	-
4	BR	-
5	W	-
6	V	-
7	P	-
13	G	-
14	BR	-

Connector No.	D107
Connector Name	DOOR MIRROR RH
Connector Color	WHITE

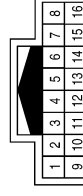

Terminal No.	Color of Wire	Signal Name
1	V	-
2	P	-
3	LG	-
9	W/B	-
10	R	-
11	G	-
12	BR	-

Connector No.	D102
Connector Name	WIRE TO WIRE
Connector Color	WHITE

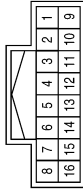

Terminal No.	Color of Wire	Signal Name
5	R	-
6	BR	-
7	W/B	-
8	G	-
14	V	-
15	P	-
16	LG	-

Connector No.	D13
Connector Name	SEAT MEMORY SWITCH
Connector Color	WHITE

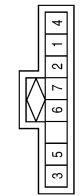

Terminal No.	Color of Wire	Signal Name
1	V	-
2	BR	-
3	W	-
4	B	-
5	GR	-
6	SB	-
7	LG	-
8	-	-

ABJIA0174GB

A  
B  
C  
D  
E  
F  
G  
H  
I  
K  
L  
M  
N  
O  
P

ADP

# BCM (BODY CONTROL MODULE)

< ECU DIAGNOSIS >

## BCM (BODY CONTROL MODULE)

Reference Value

INFOID:000000004375877

### VALUES ON THE DIAGNOSIS TOOL

Monitor Item	Condition	Value/Status
FR WIPER HI	Other than front wiper switch HI	OFF
	Front wiper switch HI	ON
FR WIPER LOW	Other than front wiper switch LO	OFF
	Front wiper switch LO	ON
FR WASHER SW	Front washer switch OFF	OFF
	Front washer switch ON	ON
FR WIPER INT	Other than front wiper switch INT	OFF
	Front wiper switch INT	ON
FR WIPER STOP	Front wiper is not in STOP position	OFF
	Front wiper is in STOP position	ON
INT VOLUME	Wiper intermittent dial is in a dial position 1 - 7	Wiper intermittent dial position
TURN SIGNAL R	Other than turn signal switch RH	OFF
	Turn signal switch RH	ON
TURN SIGNAL L	Other than turn signal switch LH	OFF
	Turn signal switch LH	ON
TAIL LAMP SW	Other than lighting switch 1ST and 2ND	OFF
	Lighting switch 1ST or 2ND	ON
HI BEAM SW	Other than lighting switch HI	OFF
	Lighting switch HI	ON
HEAD LAMP SW 1	Other than lighting switch 2ND	OFF
	Lighting switch 2ND	ON
HEAD LAMP SW 2	Other than lighting switch 2ND	OFF
	Lighting switch 2ND	ON
PASSING SW	Other than lighting switch PASS	OFF
	Lighting switch PASS	ON
AUTO LIGHT SW	Other than lighting switch AUTO	OFF
	Lighting switch AUTO	ON
FR FOG SW	Front fog lamp switch OFF	OFF
	Front fog lamp switch ON	ON
DOOR SW-DR	Driver door closed	OFF
	Driver door opened	ON
DOOR SW-AS	Passenger door closed	OFF
	Passenger door opened	ON
DOOR SW-RR	Rear door RH closed	OFF
	Rear door RH opened	ON
DOOR SW-RL	Rear door LH closed	OFF
	Rear door LH opened	ON
DOOR SW-BK	<b>NOTE:</b> This item is displayed, but cannot be monitored.	OFF

## BCM (BODY CONTROL MODULE)

### < ECU DIAGNOSIS >

Monitor Item	Condition	Value/Status	
CDL LOCK SW	Other than power door lock switch LOCK	OFF	A
	Power door lock switch LOCK	ON	
CDL UNLOCK SW	Other than power door lock switch UNLOCK	OFF	B
	Power door lock switch UNLOCK	ON	
KEY CYL LK-SW	Other than driver door key cylinder LOCK position	OFF	C
	Driver door key cylinder LOCK position	ON	
KEY CYL UN-SW	Other than driver door key cylinder UNLOCK position	OFF	D
	Driver door key cylinder UNLOCK position	ON	
KEY CYL SW-TR	<b>NOTE:</b> This item is displayed, but cannot be monitored.	OFF	
HAZARD SW	When hazard switch is not pressed	OFF	E
	When hazard switch is pressed	ON	
REAR DEF SW	When rear window defogger switch is pressed	ON	
TR CANCEL SW	Trunk lid opener cancel switch OFF	OFF	F
	Trunk lid opener cancel switch ON	ON	
TR/BD OPEN SW	Trunk lid opener switch OFF	OFF	G
	While the trunk lid opener switch is turned ON	ON	
TRNK/HAT MNTR	Trunk lid closed	OFF	H
	Trunk lid opened	ON	
RKE-LOCK	When LOCK button of Intelligent Key is not pressed	OFF	I
	When LOCK button of Intelligent Key is pressed	ON	
RKE-UNLOCK	When UNLOCK button of Intelligent Key is not pressed	OFF	
	When UNLOCK button of Intelligent Key is pressed	ON	
RKE-TR/BD	When TRUNK OPEN button of Intelligent Key is not pressed	OFF	ADP
	When TRUNK OPEN button of Intelligent Key is pressed	ON	
RKE-PANIC	When PANIC button of Intelligent Key is not pressed	OFF	K
	When PANIC button of Intelligent Key is pressed	ON	
RKE-P/W OPEN	When UNLOCK button of Intelligent Key is not pressed and held	OFF	L
	When UNLOCK button of Intelligent Key is pressed and held	ON	
RKE-MODE CHG	When LOCK/UNLOCK button of Intelligent Key is not pressed and held simultaneously	OFF	M
	When LOCK/UNLOCK button of Intelligent Key is pressed and held simultaneously	ON	
OPTICAL SENSOR	When outside of the vehicle is bright	Close to 5 V	N
	When outside of the vehicle is dark	Close to 0 V	
REQ SW-DR	When front door request switch is not pressed (driver side)	OFF	O
	When front door request switch is pressed (driver side)	ON	
REQ SW-AS	When front door request switch is not pressed (passenger side)	OFF	P
	When front door request switch is pressed (passenger side)	ON	
REQ SW-RL	When rear door request switch is not pressed (driver side)	OFF	
	When rear door request switch is pressed (driver side)	ON	
REQ SW-RR	When rear door request switch is not pressed (passenger side)	OFF	
	When rear door request switch is pressed (passenger side)	ON	
REQ SW-BD/TR	When trunk request switch is not pressed	OFF	
	When trunk request switch is pressed	ON	

## BCM (BODY CONTROL MODULE)

### < ECU DIAGNOSIS >

Monitor Item	Condition	Value/Status
PUSH SW	When engine switch (push switch) is not pressed	OFF
	When engine switch (push switch) is pressed	ON
IGN RLY 2-F/B	Ignition switch OFF or ACC	OFF
	Ignition switch ON	ON
ACC RLY-F/B	Ignition switch OFF	OFF
	Ignition switch ACC or ON	ON
CLUTCH SW	<b>NOTE:</b> This item is displayed, but cannot be monitored.	OFF
BRAKE SW 1	When the brake pedal is not depressed	ON
	When the brake pedal is depressed	OFF
DETE/CANCL SW	When selector lever is in P position	OFF
	When selector lever is in any position other than P	ON
SFT PN/N SW	When selector lever is in any position other than P or N	OFF
	When selector lever is in P or N position	ON
S/L-LOCK	Electronic steering column lock LOCK status	OFF
	Electronic steering column lock UNLOCK status	ON
S/L-UNLOCK	Electronic steering column lock UNLOCK status	OFF
	Electronic steering column lock LOCK status	ON
S/L RELAY-F/B	Ignition switch OFF or ACC	OFF
	Ignition switch ON	ON
UNLK SEN-DR	Driver door UNLOCK status	OFF
	Driver door LOCK status	ON
PUSH SW-IPDM	When engine switch (push switch) is not pressed	OFF
	When engine switch (push switch) is pressed	ON
IGN RLY1 F/B	Ignition switch OFF or ACC	OFF
	Ignition switch ON	ON
DETE SW -IPDM	When selector lever is in P position	OFF
	When selector lever is in any position other than P	ON
SFT PN -IPDM	When selector lever is in any position other than P or N	OFF
	When selector lever is in P or N position	ON
SFT P-MET	When selector lever is in any position other than P	OFF
	When selector lever is in P position	ON
SFT N-MET	When selector lever is in any position other than N	OFF
	When selector lever is in N position	ON
ENGINE STATE	Engine stopped	STOP
	While the engine stalls	STALL
	At engine cranking	CRANK
	Engine running	RUN
S/L LOCK-IPDM	Electronic steering column lock LOCK status	OFF
	Electronic steering column lock UNLOCK status	ON
S/L UNLCK-IPDM	Electronic steering column lock UNLOCK status	OFF
	Electronic steering column lock LOCK status	ON
S/L RELAY-REQ	Ignition switch OFF or ACC	OFF
	Ignition switch ON	ON
VEH SPEED 1	While driving	Equivalent to speedometer reading



## BCM (BODY CONTROL MODULE)

### < ECU DIAGNOSIS >

Monitor Item	Condition	Value/Status	
VEH SPEED 2	While driving	Equivalent to speedometer reading	A
DOOR STAT-DR	Driver door LOCK status	LOCK	B
	Wait with selective UNLOCK operation (5 seconds)	READY	
	Driver door UNLOCK status	UNLK	
DOOR STAT-AS	Passenger door LOCK status	LOCK	C
	Wait with selective UNLOCK operation (5 seconds)	READY	
	Passenger door UNLOCK status	UNLK	
ID OK FLAG	Ignition switch ACC or ON	RESET	D
	Ignition switch OFF	SET	
PRMT ENG STAT	When the engine start is prohibited	RESET	E
	When the engine start is permitted	SET	
PRMT RKE STAT	<b>NOTE:</b> This item is displayed, but cannot be monitored.	RESET	
KEY SW -SLOT	When Intelligent Key is not inserted into key slot	OFF	F
	When Intelligent Key is inserted into key slot	ON	
RKE OPE COUN1	During the operation of Intelligent Key	Operation frequency of Intelligent Key	G
RKE OPE COUN2	<b>NOTE:</b> This item is displayed, but cannot be monitored.	Operation frequency of Intelligent Key	
CONFIRM ID ALL	The key ID that the key slot receives does not accord with any key ID registered to BCM.	YET	H
	The key ID that the key slot receives accords with any key ID registered to BCM.	DONE	
CONFIRM ID4	The key ID that the key slot receives does not accord with the fourth key ID registered to BCM.	YET	I
	The key ID that the key slot receives accords with the fourth key ID registered to BCM.	DONE	
CONFIRM ID3	The key ID that the key slot receives does not accord with the third key ID registered to BCM.	YET	K
	The key ID that the key slot receives accords with the third key ID registered to BCM.	DONE	
CONFIRM ID2	The key ID that the key slot receives does not accord with the second key ID registered to BCM.	YET	L
	The key ID that the key slot receives accords with the second key ID registered to BCM.	DONE	
CONFIRM ID1	The key ID that the key slot receives does not accord with the first key ID registered to BCM.	YET	M
	The key ID that the key slot receives accords with the first key ID registered to BCM.	DONE	
TP 4	The ID of fourth key is not registered to BCM	YET	O
	The ID of fourth key is registered to BCM	DONE	
TP 3	The ID of third key is not registered to BCM	YET	P
	The ID of third key is registered to BCM	DONE	
TP 2	The ID of second key is not registered to BCM	YET	P
	The ID of second key is registered to BCM	DONE	
TP 1	The ID of first key is not registered to BCM	YET	P
	The ID of first key is registered to BCM	DONE	
AIR PRESS FL	Ignition switch ON (only when the signal from the transmitter is received)	Air pressure of front LH tire	

ADP

## BCM (BODY CONTROL MODULE)

### < ECU DIAGNOSIS >

Monitor Item	Condition	Value/Status
AIR PRESS FR	Ignition switch ON (only when the signal from the transmitter is received)	Air pressure of front RH tire
AIR PRESS RR	Ignition switch ON (only when the signal from the transmitter is received)	Air pressure of rear RH tire
AIR PRESS RL	Ignition switch ON (only when the signal from the transmitter is received)	Air pressure of rear LH tire
ID REGST FL1	When ID of front LH tire transmitter is registered	DONE
	When ID of front LH tire transmitter is not registered	YET
ID REGST FR1	When ID of front RH tire transmitter is registered	DONE
	When ID of front RH tire transmitter is not registered	YET
ID REGST RR1	When ID of rear RH tire transmitter is registered	DONE
	When ID of rear RH tire transmitter is not registered	YET
ID REGST RL1	When ID of rear LH tire transmitter is registered	DONE
	When ID of rear LH tire transmitter is not registered	YET
WARNING LAMP	Tire pressure indicator OFF	OFF
	Tire pressure indicator ON	ON
BUZZER	Tire pressure warning alarm is not sounding	OFF
	Tire pressure warning alarm is sounding	ON

# BCM (BODY CONTROL MODULE)

< ECU DIAGNOSIS >

## Terminal Layout

INFOID:000000004375878

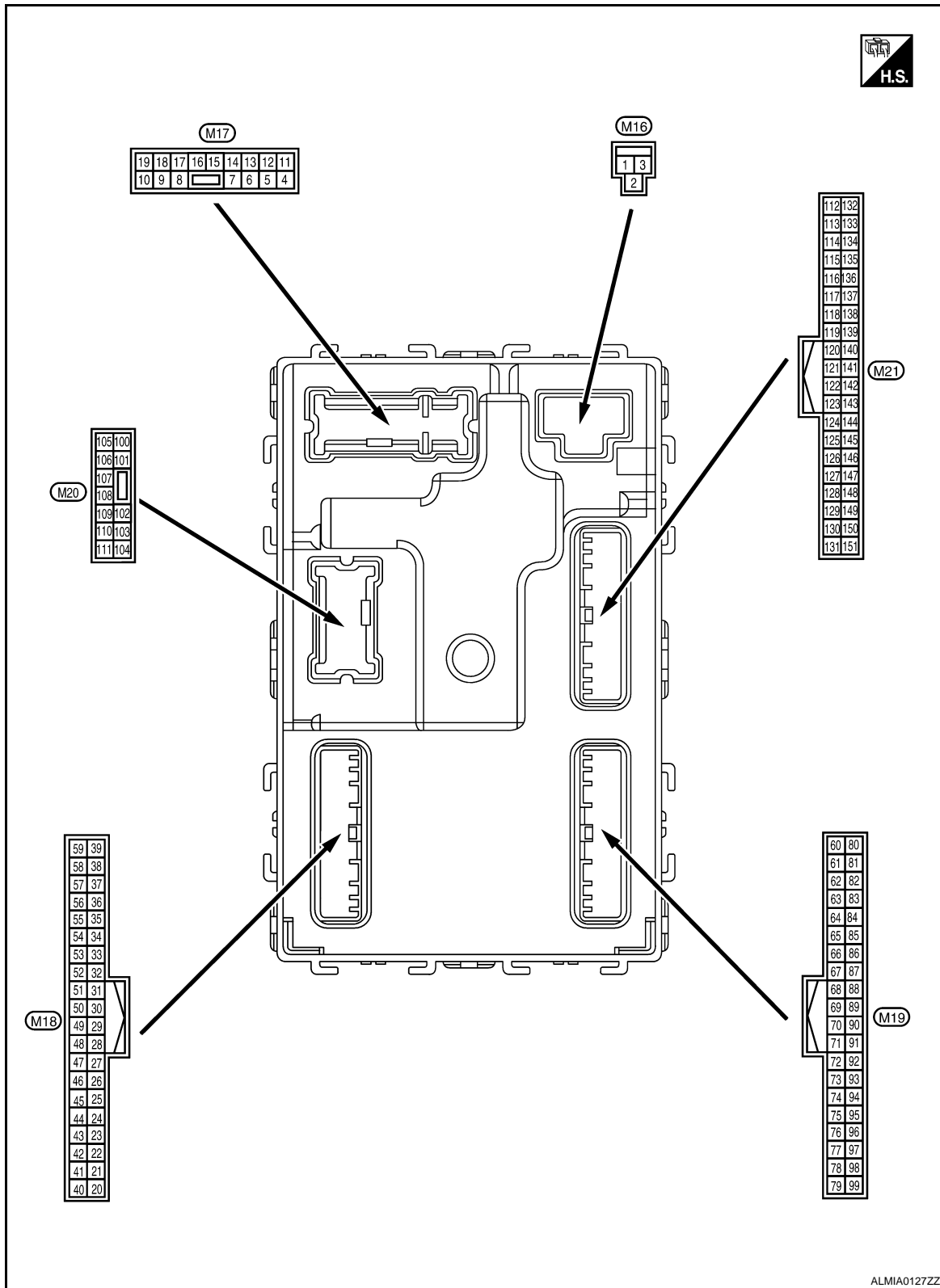

A  
B  
C  
D  
E  
F  
G  
H  
I  
K  
L  
M  
N  
O  
P

ADP

Physical Values

INFOID:000000004375879

# BCM (BODY CONTROL MODULE)

## < ECU DIAGNOSIS >

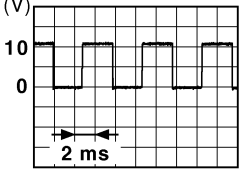
Terminal No. (Wire color)		Description		Condition		Value (Approx.)
		Signal name	Input/ Output			
(+)	(-)					
1 (W/B)	Ground	Battery power supply	Input	Ignition switch OFF		Battery voltage
2 (R/Y)	Ground	Battery power supply output	Output	Ignition switch OFF		Battery voltage
3 (L/W)	Ground	Ignition power supply output	Output	Ignition switch ON		Battery voltage
4 (P/W)	Ground	Interior room lamp power supply	Output	After passing the interior room lamp battery saver operation time		0V
				Any other time after passing the interior room lamp battery saver operation time		Battery voltage
5 (G)	Ground	Front door RH UNLOCK	Output	Front door RH	UNLOCK (actuator is activated)	Battery voltage
					Other than UNLOCK (actuator is not activated)	0V
7 (R/W)	Ground	Step lamp	Output	Step lamp	ON	0V
					OFF	Battery voltage
8 (V)	Ground	All doors LOCK	Output	All doors	LOCK (actuator is activated)	Battery voltage
					Other than LOCK (actuator is not activated)	0V
9 (L)	Ground	Front door LH UNLOCK	Output	Front door LH	UNLOCK (actuator is activated)	Battery voltage
					Other than UNLOCK (actuator is not activated)	0V
10 (G)	Ground	Rear door RH and rear door LH UNLOCK	Output	Rear door RH and rear door LH	UNLOCK (actuator is activated)	Battery voltage
					Other than UNLOCK (actuator is not activated)	0V
11 (Y/R)	Ground	Battery power supply	Input	Ignition switch OFF		Battery voltage
13 (B)	Ground	Ground	—	Ignition switch ON		0V
14 (GR/W)	Ground	Engine switch (push switch) illumination ground	Input	Tail lamp	OFF	0V
					ON	<p><b>NOTE:</b> When the illumination brightening/dimming level is in the neutral position</p>  <p style="text-align: right;">JSNIA0010GB</p>
15 (Y/L)	Ground	ACC indicator lamp	Output	Ignition switch	OFF	Battery voltage
					ACC or ON	0V

# BCM (BODY CONTROL MODULE)

## < ECU DIAGNOSIS >

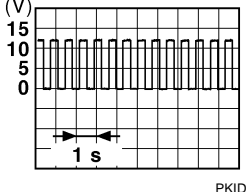
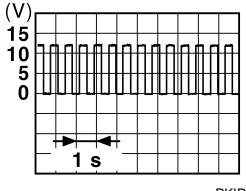
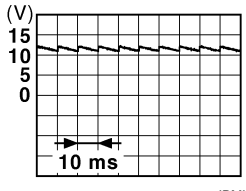

Terminal No. (Wire color)		Description		Condition		Value (Approx.)
(+)	(-)	Signal name	Input/ Output			
17 (G/B)	Ground	Turn signal (RH)	Output	Ignition switch ON	Turn signal switch OFF	0V
					Turn signal switch RH	
18 (G/Y)	Ground	Turn signal (LH)	Output	Ignition switch ON	Turn signal switch OFF	0V
					Turn signal switch LH	
19 (Y)	Ground	Room lamp timer control	Output	Interior room lamp	OFF	Battery voltage
					ON	0V
21 (P/B)	Ground	Optical sensor signal	Input	Ignition switch ON	When outside of the vehi- cle is bright	Close to 5V
					When outside of the vehi- cle is dark	Close to 0V
24 (R/W)	Ground	Stop lamp switch 1	Input	—	Battery voltage	
26 (O/L)	Ground	Stop lamp switch 2	Input	Stop lamp switch	OFF (brake pedal is not de- pressed)	0V
					ON (brake pedal is de- pressed)	Battery voltage
27 (O)	Ground	Front door lock as- sembly LH (unlock sensor)	Input	Front door LH	LOCK status	
					UNLOCK status	0V
29 (Y)	Ground	Key slot switch	Input	When Intelligent Key is inserted into key slot	Battery voltage	
				When Intelligent Key is not inserted into key slot	0V	
30 (V/Y)	Ground	ACC feedback signal	Input	Ignition switch	OFF	0
				ACC or ON	Battery voltage	
31 (G)	Ground	Rear window defog- ger feedback signal	Input	Rear window de- fogger switch	OFF	0V
				ON	Battery voltage	

A  
B  
C  
D  
E  
F  
G  
H  
I  
K  
L  
M  
N  
O  
P

ADP

# BCM (BODY CONTROL MODULE)

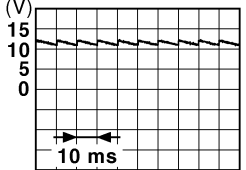
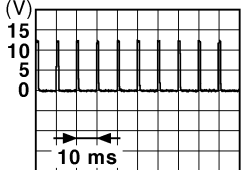
## < ECU DIAGNOSIS >

Terminal No. (Wire color)		Description		Condition		Value (Approx.)
(+)	(-)	Signal name	Input/ Output			
32 (R/B)	Ground	Front door RH switch	Input	Front door RH switch	OFF (when front door RH closes)	 <p style="text-align: right; font-size: small;">JPMIA0011GB</p> <p style="text-align: center;">11.8 V</p>
					ON (when front door RH opens)	0V
37 (O)	Ground	Trunk lid opener cancel switch	Input	Trunk lid opener cancel switch	CANCEL	 <p style="text-align: right; font-size: small;">JPMIA0012GB</p> <p style="text-align: center;">1.1V</p>
					ON	0V
38 (GR/W)	Ground	Rear window defogger ON signal	Input	Rear window defogger switch	OFF	5V
					ON	0V
40 (Y/G)	Ground	Power window serial link	Input/ Output	Ignition switch ON	 <p style="text-align: right; font-size: small;">JPMIA0013GB</p> <p style="text-align: center;">10.2V</p>	
				Ignition switch OFF or ACC	0V	
41 (W)	Ground	Engine switch (push switch) illumination	Output	Engine switch (push switch) illumination	ON	5.5V
					OFF	0V
42 (R)	Ground	LOCK indicator lamp	Output	LOCK indicator lamp	ON	0V
					OFF	Battery voltage
45 (P)	Ground	Receiver & sensor ground	Input	Ignition switch ON		0V
46 (V/W)	Ground	Receiver & sensor power supply output	Output	Ignition switch	OFF	0V
					ACC or ON	5.0V

# BCM (BODY CONTROL MODULE)

## < ECU DIAGNOSIS >

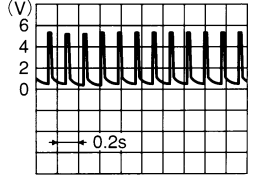
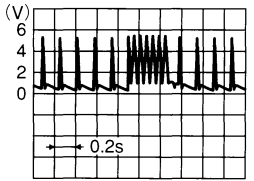
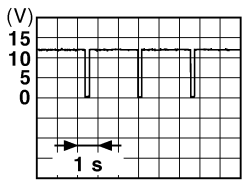
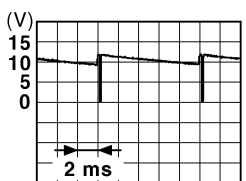
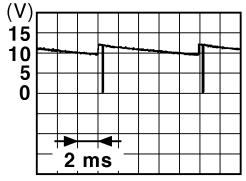
Terminal No. (Wire color)		Description		Condition	Value (Approx.)
(+)	(-)	Signal name	Input/ Output		
47 (G/O)	Ground	Tire pressure receiver signal	Input/ Output	Ignition switch ON	Standby state  OCC3881D
				When receiving the signal from the transmitter  OCC3880D	
48 (R/G)	Ground	Selector lever P/N position signal	Input	Selector lever	P or N position 12.0V
				Except P and N positions 0V	
49 (L/O)	Ground	Security indicator signal	Output	Security indicator	ON 0V
				Blinking  11.3V JPMIA0014GB	
50 (LG/B)	Ground	Combination switch OUTPUT 5	Output	Combination switch (Wiper intermittent dial 4)	All switch OFF 0V
				Lighting switch 1ST	 10.7V JPMIA0031GB
				Lighting switch high-beam	
				Lighting switch 2ND	
Turn signal switch RH					
51 (L/W)	Ground	Combination switch OUTPUT 1	Output	Combination switch	All switch OFF (Wiper intermittent dial 4) 0V
				Front wiper switch HI (Wiper intermittent dial 4)	 10.7V JPMIA0032GB
				Any of the conditions below with all switch OFF <ul style="list-style-type: none"> <li>• Wiper intermittent dial 1</li> <li>• Wiper intermittent dial 2</li> <li>• Wiper intermittent dial 3</li> <li>• Wiper intermittent dial 6</li> <li>• Wiper intermittent dial 7</li> </ul>	

A  
B  
C  
D  
E  
F  
G  
H  
I  
K  
L  
M  
N  
O  
P

ADP

# BCM (BODY CONTROL MODULE)

## < ECU DIAGNOSIS >

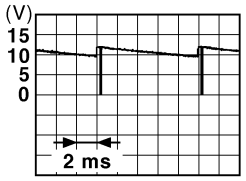
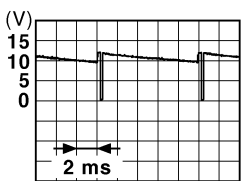
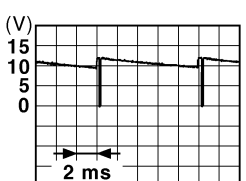
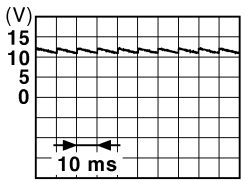
Terminal No. (Wire color)		Description		Condition	Value (Approx.)	
(+)	(-)	Signal name	Input/ Output			
52 (G/B)	Ground	Combination switch OUTPUT 2	Output	Combination switch	All switch OFF (Wiper intermittent dial 4)	0V
					Front washer switch ON (Wiper intermittent dial 4)	
					Any of the conditions below with all switch OFF	
					<ul style="list-style-type: none"> <li>• Wiper intermittent dial 1</li> <li>• Wiper intermittent dial 5</li> <li>• Wiper intermittent dial 6</li> </ul>	
					10.7V	
53 (LG/ R)	Ground	Combination switch OUTPUT 3	Output	Combination switch (Wiper intermit- tent dial 4)	All switch OFF	0V
					Front wiper switch INT	
					Front wiper switch LO	
					Lighting switch AUTO	
					10.7V	
54 (G/Y)	Ground	Combination switch OUTPUT 4	Output	Combination switch (Wiper intermit- tent dial 4)	All switch OFF	0V
					Front fog lamp switch ON	
					Lighting switch 2ND	
					Lighting switch flash-to- pass	
					10.7V	
57 (W)	Ground	Tire pressure warn- ing check switch	Input	—	5V	
58 (SB)	Ground	Front door LH switch	Input	Front door LH switch	OFF (front door LH CLOSE)	
					ON (front door LH OPEN)	
59 (G/R)	Ground	Rear window defog- ger relay	Output	Rear window de- fogger	Active	Battery voltage
					Not activated	0V



# BCM (BODY CONTROL MODULE)

## < ECU DIAGNOSIS >

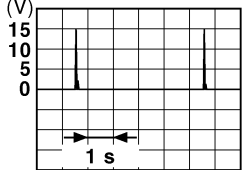
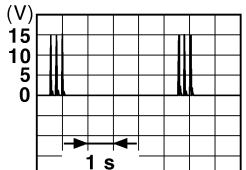
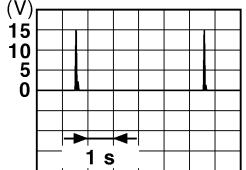
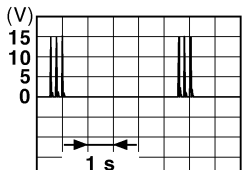
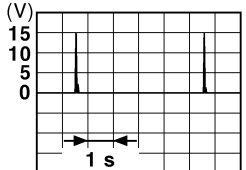
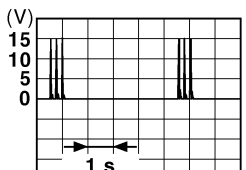
Terminal No. (Wire color)		Description		Condition	Value (Approx.)
(+)	(-)	Signal name	Input/ Output		
60 (B/R)	Ground	Front console antenna 2 (-)	Output	When Intelligent Key is in the passenger compartment	 <p style="text-align: right; font-size: small;">JMKIA0062GB</p>
				When Intelligent Key is not in the passenger compartment	 <p style="text-align: right; font-size: small;">JMKIA0063GB</p>
61 (W/R)	Ground	Center console antenna 2 (+)	Output	When Intelligent Key is in the passenger compartment	 <p style="text-align: right; font-size: small;">JMKIA0062GB</p>
				When Intelligent Key is not in the passenger compartment	 <p style="text-align: right; font-size: small;">JMKIA0063GB</p>
62 (V)	Ground	Front outside handle RH antenna (-)	Output	When the front door RH request switch is operated with ignition switch OFF	 <p style="text-align: right; font-size: small;">JMKIA0062GB</p>
				When Intelligent Key is not in the antenna detection area	 <p style="text-align: right; font-size: small;">JMKIA0063GB</p>

A  
B  
C  
D  
E  
F  
G  
H  
I  
ADP  
K  
L  
M  
N  
O  
P

# BCM (BODY CONTROL MODULE)

## < ECU DIAGNOSIS >

Terminal No. (Wire color)		Description		Condition	Value (Approx.)
(+)	(-)	Signal name	Input/ Output		
63 (P)	Ground	Front outside handle RH antenna (+)	Output	When the front door RH request switch is operated with ignition switch OFF	<p style="text-align: right; font-size: small;">JMKIA0062GB</p>
				When Intelligent Key is not in the antenna detection area	<p style="text-align: right; font-size: small;">JMKIA0063GB</p>
64 (V)	Ground	Front outside handle LH antenna (-)	Output	When the front door LH request switch is operated with ignition switch OFF	<p style="text-align: right; font-size: small;">JMKIA0062GB</p>
				When Intelligent Key is not in the antenna detection area	<p style="text-align: right; font-size: small;">JMKIA0063GB</p>
65 (P)	Ground	Front outside handle LH antenna (+)	Output	When the front door LH request switch is operated with ignition switch OFF	<p style="text-align: right; font-size: small;">JMKIA0062GB</p>
				When Intelligent Key is not in the antenna detection area	<p style="text-align: right; font-size: small;">JMKIA0063GB</p>

# BCM (BODY CONTROL MODULE)





## < ECU DIAGNOSIS >

Terminal No. (Wire color)		Description		Condition	Value (Approx.)
(+)	(-)	Signal name	Input/ Output		
66 (R)	Ground	Instrument panel antenna (-)	Output	Ignition switch OFF	<p style="text-align: right; font-size: small;">JMKIA0062GB</p>
				When Intelligent Key is not in the passenger compartment	<p style="text-align: right; font-size: small;">JMKIA0063GB</p>
67 (G)	Ground	Instrument panel antenna (+)	Output	Ignition switch OFF	<p style="text-align: right; font-size: small;">JMKIA0062GB</p>
				When Intelligent Key is not in the passenger compartment	<p style="text-align: right; font-size: small;">JMKIA0063GB</p>
68 (G/O)	Ground	NATS antenna amp (built in key slot)	Input/ Output	During waiting	Ignition switch is pressed while inserting the Intelligent Key into the key slot. Just after pressing ignition switch. Pointer of tester should move.
69 (O)	Ground	NATS antenna amp (built in key slot)	Input/ Output	During waiting	Ignition switch is pressed while inserting the Intelligent Key into the key slot. Just after pressing ignition switch. Pointer of tester should move.
70 (R/B)	Ground	Ignition relay-2 control	Output	Ignition switch OFF or ACC	0V
				ON	Battery voltage

A  
B  
C  
D  
E  
F  
G  
H  
I  
ADP  
K  
L  
M  
N  
O  
P

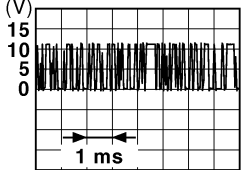
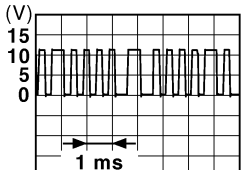

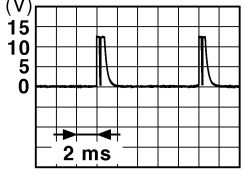
# BCM (BODY CONTROL MODULE)

## < ECU DIAGNOSIS >

Terminal No. (Wire color)		Description		Condition	Value (Approx.)
(+)	(-)	Signal name	Input/ Output		
71 (L/O)	Ground	Remote keyless entry receiver signal	Input/ Output	During waiting	 <p style="text-align: right; font-size: small;">JMKIA0064GB</p>
				When operating either button on Intelligent Key	 <p style="text-align: right; font-size: small;">JMKIA0065GB</p>
75 (R/Y)	Ground	Combination switch INPUT 5	Input	Combination switch	<p>All switch OFF (Wiper intermittent dial 4)</p>  <p style="text-align: right; font-size: small;">JPMIA0041GB</p> <p style="text-align: center;">1.4V</p>
				Combination switch	<p>Front fog lamp switch ON (Wiper intermittent dial 4)</p>  <p style="text-align: right; font-size: small;">JPMIA0037GB</p> <p style="text-align: center;">1.3V</p>
				Combination switch	<p>Any of the conditions below with all switch OFF</p> <ul style="list-style-type: none"> <li>• Wiper intermittent dial 1</li> <li>• Wiper intermittent dial 2</li> <li>• Wiper intermittent dial 6</li> <li>• Wiper intermittent dial 7</li> </ul>  <p style="text-align: right; font-size: small;">JPMIA0040GB</p> <p style="text-align: center;">1.3V</p>

# BCM (BODY CONTROL MODULE)

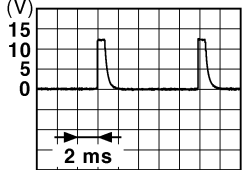
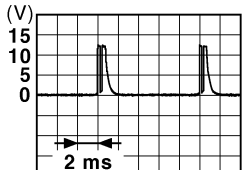
## < ECU DIAGNOSIS >

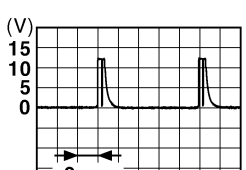
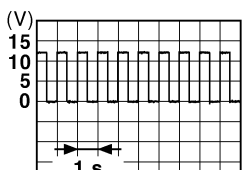
Terminal No. (Wire color)		Description		Condition	Value (Approx.)	
		Signal name	Input/ Output			
(+)	(-)					
76 (R/G)	Ground	Combination switch INPUT 3	Input	Combination switch	All switch OFF (Wiper intermittent dial 4)	 <small>JPMIA0041GB</small> 1.4V
					Lighting switch high-beam (Wiper intermittent dial 4)	 <small>JPMIA0036GB</small> 1.3V
					Lighting switch 2ND (Wiper intermittent dial 4)	 <small>JPMIA0037GB</small> 1.3V
					Any of the conditions below with all switch OFF <ul style="list-style-type: none"> <li>• Wiper intermittent dial 1</li> <li>• Wiper intermittent dial 2</li> <li>• Wiper intermittent dial 3</li> </ul>	 <small>JPMIA0040GB</small> 1.3V
77 (BR)	Ground	Engine switch (push switch)	Input	Engine switch (push switch)	Pressed	0V
					Not pressed	Battery voltage
78 (P)	Ground	CAN-L	Input/ Output	—	—	
79 (L)	Ground	CAN-H	Input/ Output	—	—	
80 (R/L)	Ground	Key slot illumination	Output	Key slot illumina- tion	OFF	0V
					Blinking	 <small>JPMIA0015GB</small> 6.5V
					ON	Battery voltage

A  
B  
C  
D  
E  
F  
G  
H  
I  
K  
L  
M  
N  
O  
P

ADP



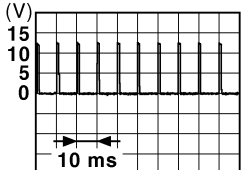
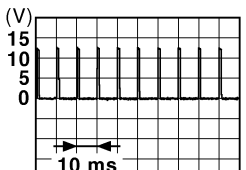

# BCM (BODY CONTROL MODULE)

## < ECU DIAGNOSIS >

Terminal No. (Wire color)		Description		Condition		Value (Approx.)
(+)	(-)	Signal name	Input/ Output			
81 (Y/L)	Ground	ON indicator lamp	Output	Ignition switch	OFF or ACC	0V
					ON	Battery voltage
83 (L)	Ground	ACC relay control	Output	Ignition switch	OFF	0V
					ACC or ON	Battery voltage
84 (Y/R)	Ground	A/T device	Output	—		Battery voltage
85 (L/O)	Ground	Electronic steering column lock condition No. 1	Input	Electronic steer- ing column lock	Lock status	0V
					Unlock status	Battery voltage
86 (G/R)	Ground	Electronic steering column lock condition No. 2	Input	Electronic steer- ing column lock	Lock status	Battery voltage
					Unlock status	0V
87 (G/B)	Ground	Selector lever P posi- tion switch	Input	Selector lever	P position	0V
					Any position other than P	Battery voltage
88 (R)	Ground	Front door RH re- quest switch	Input	Front door RH re- quest switch	ON (pressed)	0V
					OFF (not pressed)	 <p style="text-align: right; margin-right: 50px;">JPMA0016GB</p> <p style="text-align: center;">1.0V</p>
89 (R)	Ground	Front door LH re- quest switch	Input	Front door LH re- quest switch	ON (pressed)	0V
					OFF (not pressed)	 <p style="text-align: right; margin-right: 50px;">JPMA0016GB</p> <p style="text-align: center;">1.0V</p>
90 (Y)	Ground	Blower fan motor re- lay control	Output	Ignition switch	OFF or ACC	0V
					ON	Battery voltage
91 (L/R)	Ground	Remote keyless entry receiver power sup- ply	Output	Ignition switch OFF		Battery voltage
94 (G/Y)	Ground	Steering wheel lock unit power supply	Output	Ignition switch	OFF or ACC	Battery voltage
					ON	0V

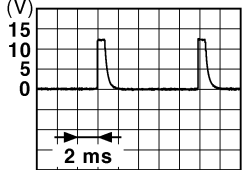
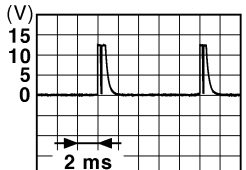
# BCM (BODY CONTROL MODULE)

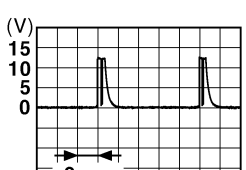
## < ECU DIAGNOSIS >

Terminal No. (Wire color)		Description		Condition	Value (Approx.)	
(+)	(-)	Signal name	Input/ Output			
95 (R/W)	Ground	Combination switch INPUT 1	Input	Combination switch (Wiper intermittent dial 4)	All switch OFF	 <p style="text-align: right; margin-right: 50px;">1.4V</p>
					Turn signal switch LH	 <p style="text-align: right; margin-right: 50px;">1.3V</p>
					Turn signal switch RH	 <p style="text-align: right; margin-right: 50px;">1.3V</p>
					Front wiper switch LO	 <p style="text-align: right; margin-right: 50px;">1.3V</p>
					Front washer switch ON	 <p style="text-align: right; margin-right: 50px;">1.3V</p>

A  
B  
C  
D  
E  
F  
G  
H  
I  
ADP  
K  
L  
M  
N  
O  
P

# BCM (BODY CONTROL MODULE)



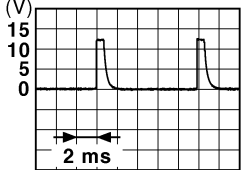
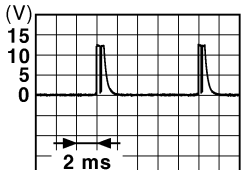
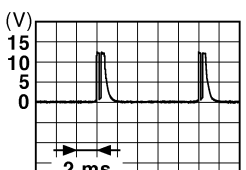
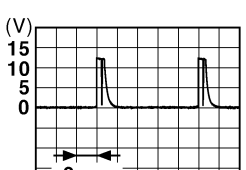

## < ECU DIAGNOSIS >

Terminal No. (Wire color)		Description		Condition	Value (Approx.)
(+)	(-)	Signal name	Input/ Output		
96 (P/B)	Ground	Combination switch INPUT 4	Input	Combination switch	All switch OFF (Wiper intermittent dial 4)  <p style="text-align: right; font-size: small;">JPMIA0041GB</p> <p style="text-align: center;">1.4V</p>
					Lighting switch AUTO (Wiper intermittent dial 4)  <p style="text-align: right; font-size: small;">JPMIA0038GB</p> <p style="text-align: center;">1.3V</p>
					Lighting switch 1ST (Wiper intermittent dial 4)  <p style="text-align: right; font-size: small;">JPMIA0036GB</p> <p style="text-align: center;">1.3V</p>
					Any of the conditions below with all switch OFF <ul style="list-style-type: none"> <li>• Wiper intermittent dial 1</li> <li>• Wiper intermittent dial 5</li> <li>• Wiper intermittent dial 6</li> </ul>  <p style="text-align: right; font-size: small;">JPMIA0039GB</p> <p style="text-align: center;">1.3V</p>

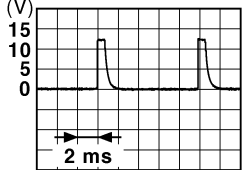
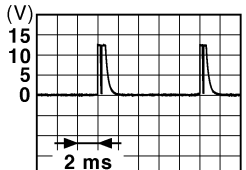

# BCM (BODY CONTROL MODULE)

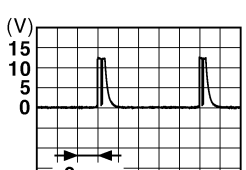
## < ECU DIAGNOSIS >

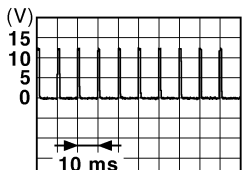
Terminal No. (Wire color)		Description		Condition	Value (Approx.)	
(+)	(-)	Signal name	Input/ Output			
97 (R/B)	Ground	Combination switch INPUT 2	Input	Combination switch (Wiper intermittent dial 4)	All switch OFF	 <p style="text-align: right;">1.4V</p>
					Lighting switch flash-to-pass	 <p style="text-align: right;">1.3V</p>
					Lighting switch 2ND	 <p style="text-align: right;">1.3V</p>
					Front wiper switch INT	 <p style="text-align: right;">1.3V</p>
					Front wiper switch HI	 <p style="text-align: right;">1.3V</p>
					Pressed	0 V
98 (G/O)	Ground	Hazard switch	Input	Hazard switch	Not pressed	 <p style="text-align: right;">1.1V</p>

A  
B  
C  
D  
E  
F  
G  
H  
I  
ADP  
K  
L  
M  
N  
O  
P

# BCM (BODY CONTROL MODULE)

## < ECU DIAGNOSIS >

Terminal No. (Wire color)		Description		Condition	Value (Approx.)	
(+)	(-)	Signal name	Input/ Output			
99 (L/Y)	Ground	Electronic steering column lock unit com- munication	Input/ Output	Electronic steer- ing column lock	LOCK status	Battery voltage
					LOCK or UNLOCK	<p style="text-align: right; font-size: small;">JMKIA0066GB</p>
					For 15 seconds after UN- LOCK	Battery voltage
					15 seconds or later after UNLOCK	0V
103 (V)	Ground	Trunk lid opening.	Output	Trunk lid	Open (trunk lid opener ac- tuator is activated)	Battery voltage
					Close (trunk lid opener ac- tuator is not activated)	0V
110 (V/W)	Ground	Trunk room lamp	Output	Trunk room lamp	ON	0V
					OFF	Battery voltage
114 (B)	Ground	Trunk room antenna 1 (-)	Output	Ignition switch OFF	When Intelligent Key is in the passenger compart- ment	<p style="text-align: right; font-size: small;">JMKIA0062GB</p>
					When Intelligent Key is not in the passenger compart- ment	<p style="text-align: right; font-size: small;">JMKIA0063GB</p>

# BCM (BODY CONTROL MODULE)

## < ECU DIAGNOSIS >

Terminal No. (Wire color)		Description		Condition	Value (Approx.)
(+)	(-)	Signal name	Input/ Output		
115 (W)	Ground	Trunk room antenna 1 (+)	Output	Ignition switch OFF	<p>JMKIA0062GB</p>
				When Intelligent Key is not in the passenger compart- ment	<p>JMKIA0063GB</p>
118 (L/O)	Ground	Rear bumper anten- na (-)	Output	When the trunk lid request switch is operated with ignition switch OFF	<p>JMKIA0062GB</p>
				When Intelligent Key is not in the antenna detection area	<p>JMKIA0063GB</p>
119 (BR/ W)	Ground	Rear bumper anten- na (+)	Output	When the trunk lid request switch is operated with ignition switch OFF	<p>JMKIA0062GB</p>
				When Intelligent Key is not in the antenna detection area	<p>JMKIA0063GB</p>

A  
B  
C  
D  
E  
F  
G  
H  
I  
K  
L  
M  
N  
O  
P

ADP

# BCM (BODY CONTROL MODULE)

## < ECU DIAGNOSIS >

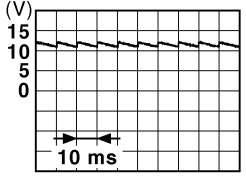
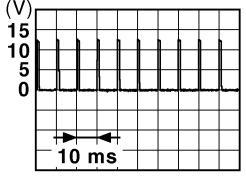
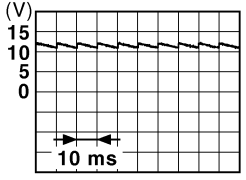
Terminal No. (Wire color)		Description		Condition	Value (Approx.)	
(+)	(-)	Signal name	Input/ Output			
127 (BR/ W)	Ground	Ignition relay (IPDM E/R) control	Output	Ignition switch	OFF or ACC	Battery voltage
					ON	0V
130 (W)	Ground	Trunk room lamp switch	Input	Trunk room lamp switch	OFF (trunk is closed)	 <p style="text-align: right; margin-right: 50px;">11.8V</p>
					ON (trunk is open)	0V
132 (R)	Ground	Starter motor relay control	Output	Ignition switch OFF (M/T vehi- cle)	When the clutch pedal is depressed	Battery voltage
					When the clutch pedal is not depressed	0V
				Ignition switch ON (other than M/ T vehicle)	When selector lever is in P or N position and the brake is depressed	Battery voltage
					When selector lever is in P or N position and the brake is not depressed	0V
141 (BR)	Ground	Trunk request switch	Input	Trunk request switch	ON (pressed)	0V
					OFF (not pressed)	 <p style="text-align: right; margin-right: 50px;">1.0V</p>
144 (GR)	Ground	Request switch buzz- er	Output	Request switch buzzer	Sounding	0V
					Not sounding	Battery voltage
147 (L/R)	Ground	Trunk lid opener switch	Input	Trunk lid opener switch	Pressed	0V
					Not pressed	Battery voltage
148 (R/W)	Ground	Rear door RH switch	Input	Rear door RH switch	OFF (when rear door RH closes)	 <p style="text-align: right; margin-right: 50px;">11.8V</p>
					ON (when rear door RH opens)	0V

# BCM (BODY CONTROL MODULE)

## < ECU DIAGNOSIS >

Terminal No. (Wire color)		Description		Condition	Value (Approx.)
		Signal name	Input/ Output		
(+)	(-)				
149 (R/B)	Ground	Rear door LH switch	Input	Rear door LH switch	OFF (when rear door LH closes)
				ON (when rear door LH opens)	0V

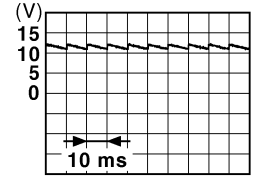

JPMIA0011GB

A  
B  
C  
D  
E  
F  
G  
H  
I  
K  
L  
M  
N  
O  
P

ADP

# BCM (BODY CONTROL MODULE)

< ECU DIAGNOSIS >

## Wiring Diagram

INFOID:000000004375880

### BCM (BODY CONTROL MODULE)

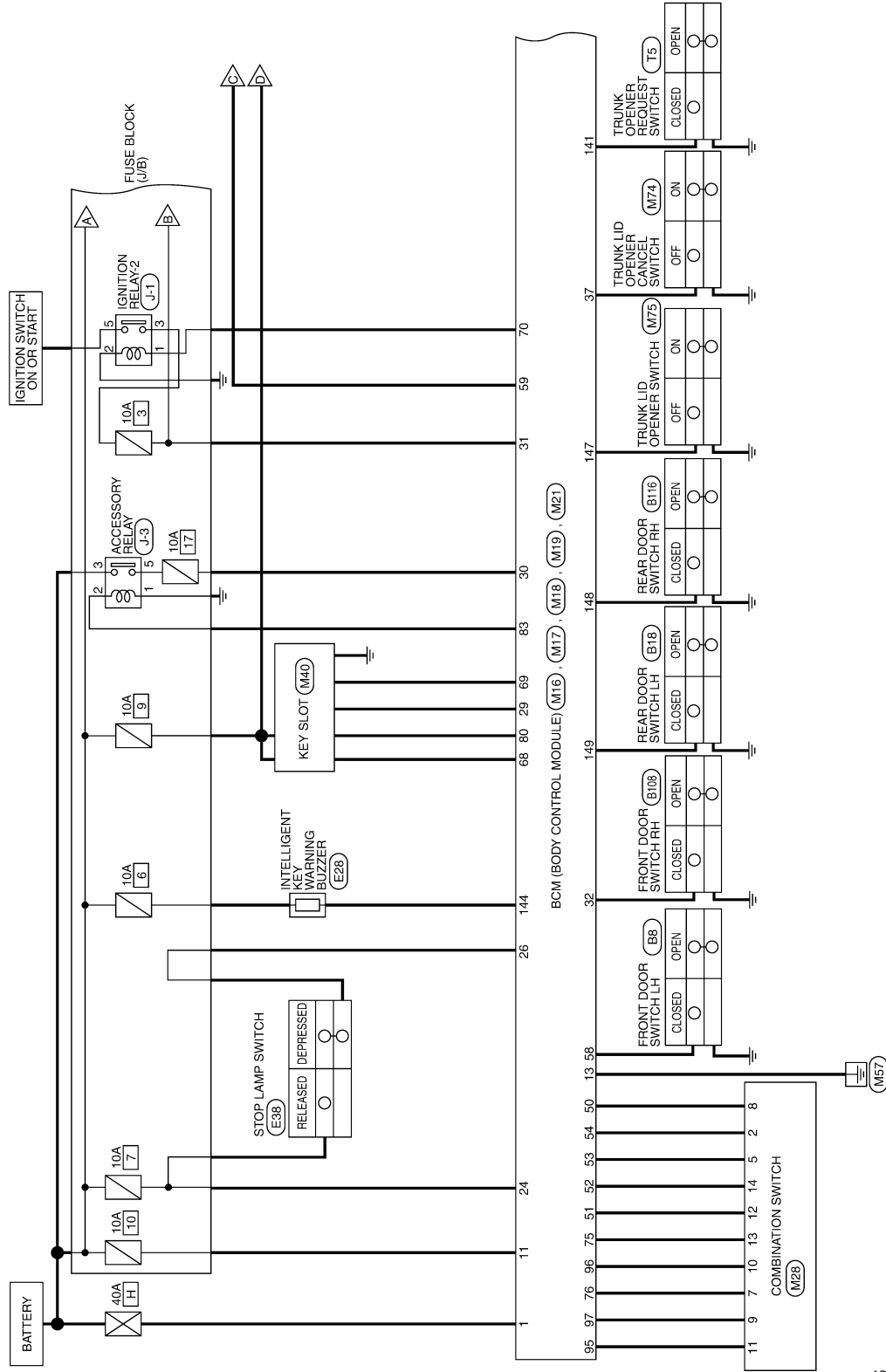

ABMWA0077GI

# BCM (BODY CONTROL MODULE)

< ECU DIAGNOSIS >

--- : DATA LINE

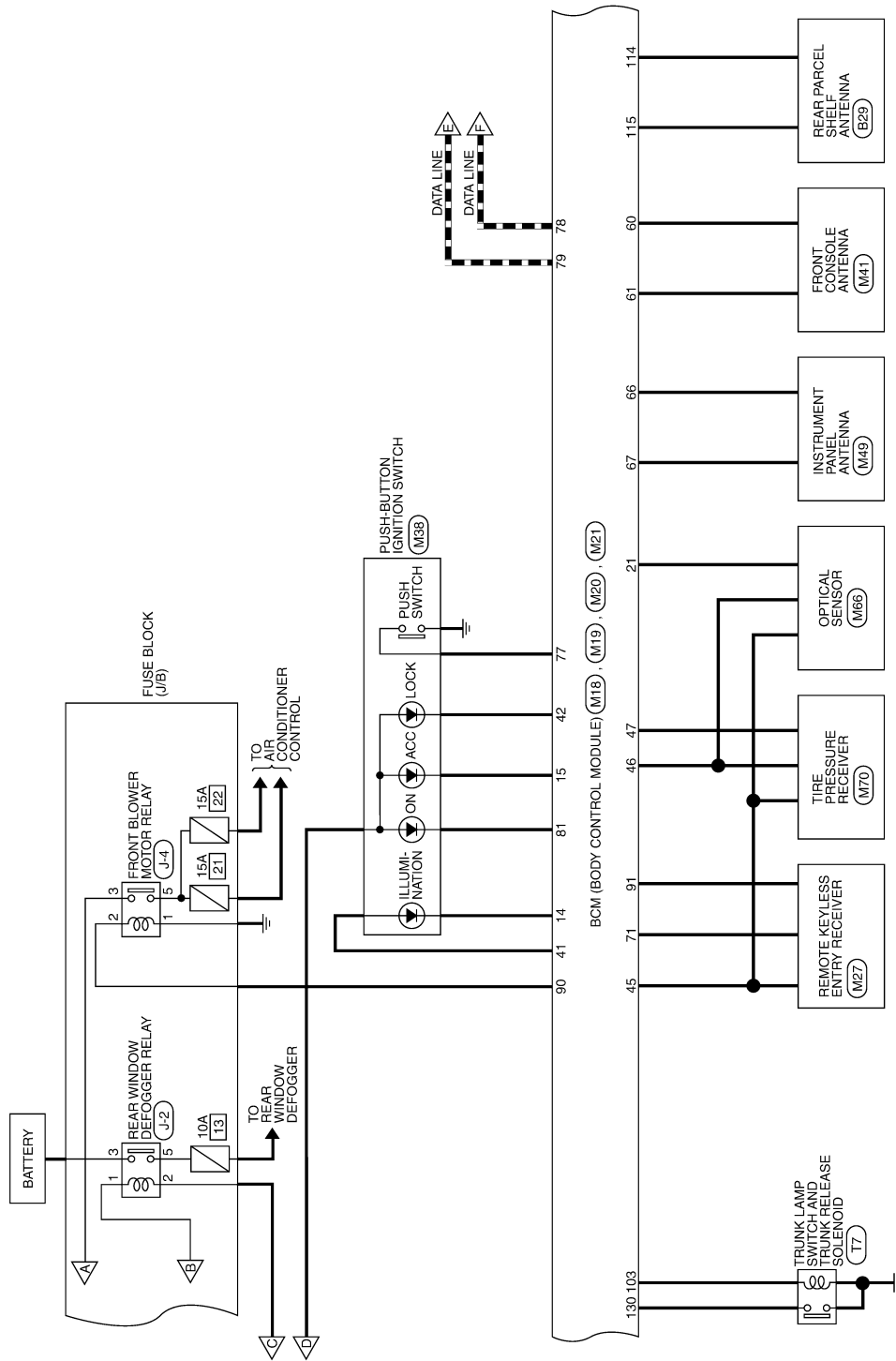

ABMWA0078GI

A  
B  
C  
D  
E  
F  
G  
H  
I  
ADP  
K  
L  
M  
N  
O  
P

# BCM (BODY CONTROL MODULE)

< ECU DIAGNOSIS >

■ : DATA LINE  
 <AD> : WITH AUTOMATIC DRIVE POSITIONER  
 <EN> : WITHOUT NAVI  
 <NV> : WITH NAVI

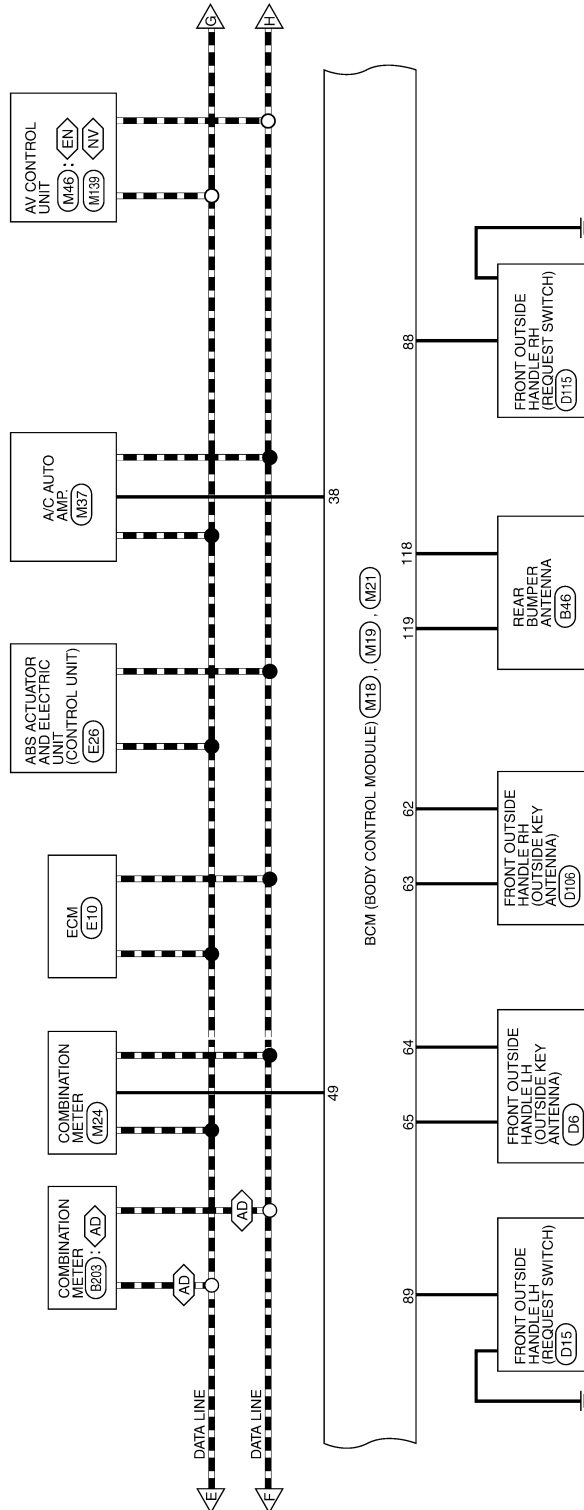

ABMWA0079GI



# BCM (BODY CONTROL MODULE)

< ECU DIAGNOSIS >

--- : DATA LINE

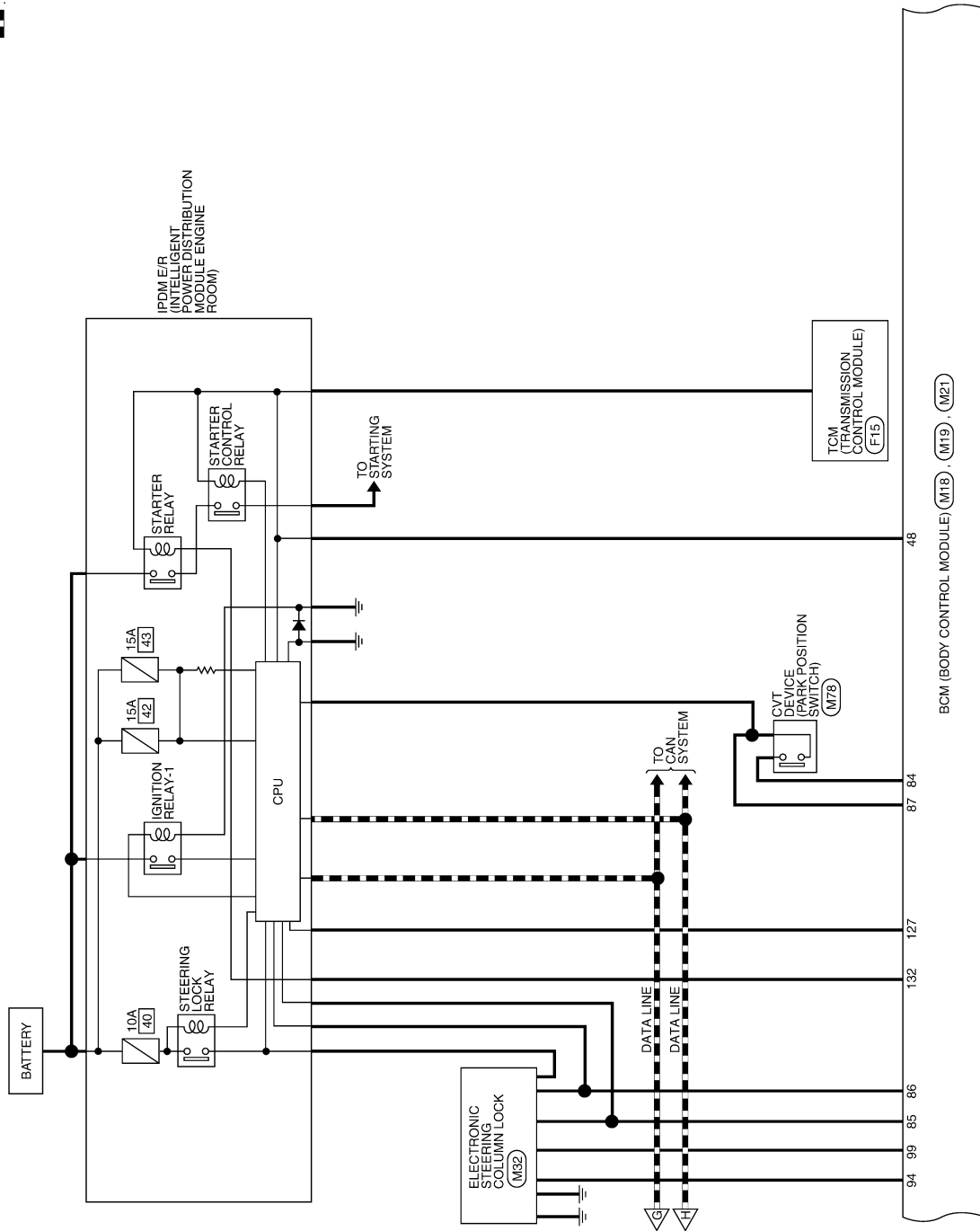

ABMWA0080GI

A  
B  
C  
D  
E  
F  
G  
H  
I  
ADP  
K  
L  
M  
N  
O  
P

# BCM (BODY CONTROL MODULE)

## < ECU DIAGNOSIS >

- $\langle A2 \rangle$  : WITH LEFT AND RIGHT FRONT POWER WINDOW ANTI-PINCH SYSTEM
- $\langle A3 \rangle$  : WITH FRONT AND REAR POWER WINDOW ANTI-PINCH SYSTEM
- $\langle DP \rangle$  : WITH DUAL PANEL SUNROOF
- $\langle DW \rangle$  : WITHOUT DUAL PANEL SUNROOF

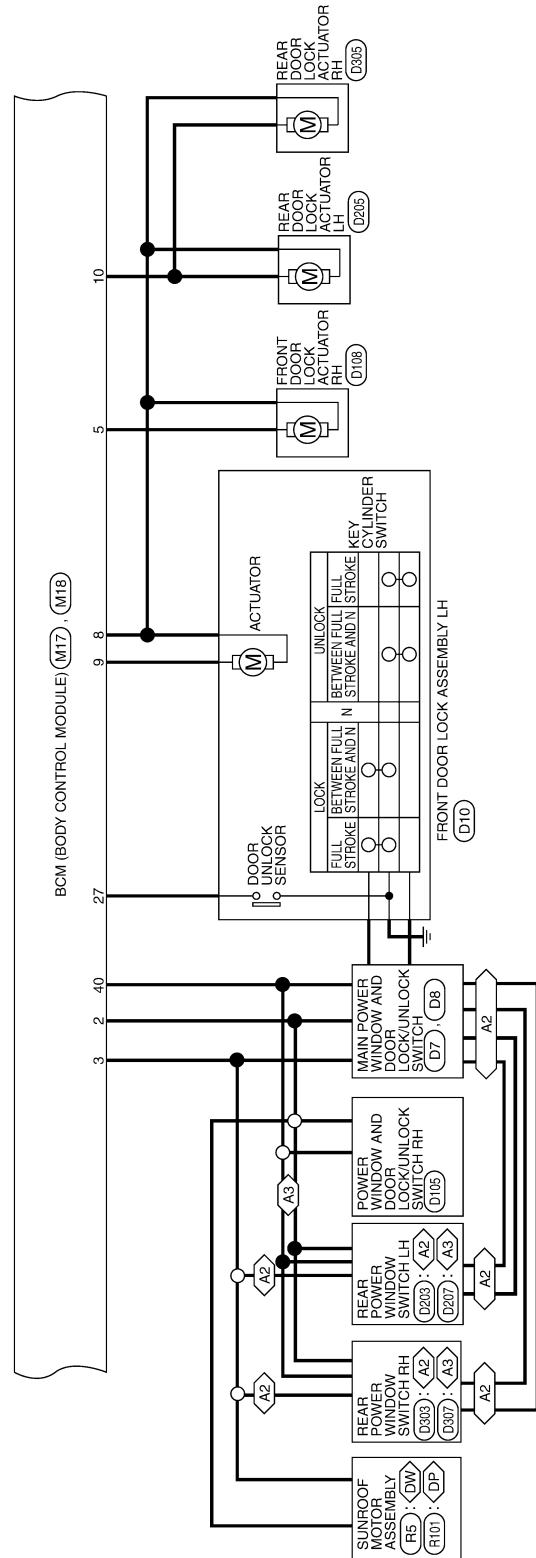

ABMWA0081G1

# BCM (BODY CONTROL MODULE)

< ECU DIAGNOSIS >

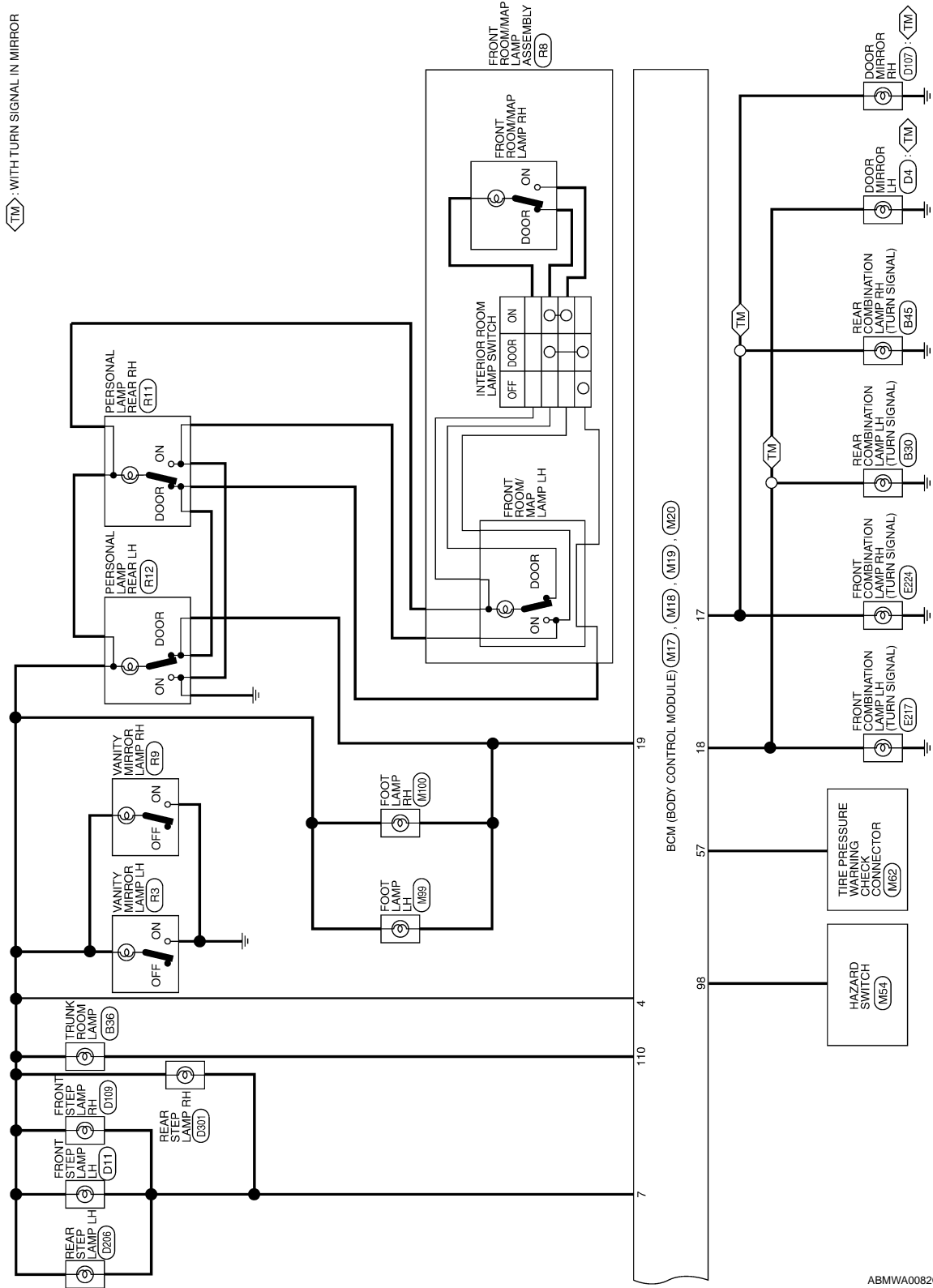

A  
B  
C  
D  
E  
F  
G  
H  
I  
K  
L  
M  
N  
O  
P

ADP

# BCM (BODY CONTROL MODULE)

< ECU DIAGNOSIS >

## BCM (BODY CONTROL MODULE) CONNECTORS

Connector No.	M16
Connector Name	BCM (BODY CONTROL MODULE)
Connector Color	BLACK



Terminal No.	Color of Wire	Signal Name
1	W/B	BAT POWER F/L
2	R/Y	P/W POWER SUPPLY PERM
3	L/W	P/W POWER SUPPLY IGN

Connector No.	M17
Connector Name	BCM (BODY CONTROL MODULE)
Connector Color	WHITE

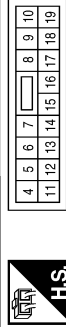

Terminal No.	Color of Wire	Signal Name
4	P/W	R/L POWER SUPPLY
5	G	DOOR UNLOCK OUTPUT AS
6	-	-
7	R/W	STEP LAMP CONT
8	V	DOOR UNLOCK OUTPUT ALL
9	L	DOOR UNLOCK OUTPUT (DR/FL)

Terminal No.	Color of Wire	Signal Name
10	G	DOOR UNLOCK OUTPUT (RR/RL)
11	Y/R	BAT BCM FUSE
12	-	-
13	B	GND1
14	GR/W	LOW SIDE PUSH LED
15	Y/L	ACC LED
16	-	-
17	G/B	FR FLASHER
18	G/Y	FL FLASHER
19	Y	ROOM LAMP CONT

Connector No.	M18
Connector Name	BCM (BODY CONTROL MODULE)
Connector Color	GREEN



Terminal No.	Color of Wire	Signal Name
20	-	-
21	P/B	A/L SIGNAL TYPE 1
22	-	-
23	-	-
24	R/W	BRAKE SW1
25	-	-
26	O/L	BRAKE SW2

Terminal No.	Color of Wire	Signal Name
27	O	DOOR LOCK STATUS DR
28	-	-
29	Y	FOB IN SW 1
30	V/Y	ACC F/B
31	G	IGN F/B
32	R/B	AS DOOR SW 1
33	-	-
34	-	-
35	-	-
36	-	-
37	O	TRUNK CANCEL SW
38	GR/W	REAR DEFOGGER SW
39	-	-
40	Y/G	PW K-LINE
41	W	PUSH LED
42	R	S/L LOCK LED
43	-	-
44	-	-

Terminal No.	Color of Wire	Signal Name
45	P	GND RF2 A/L
46	V/W	A/L POWER SUPPLY 5V
47	G/O	RF2 TUNER SIGNAL
48	R/G	SHIFT N/P/NEUTRAL SW
49	L/O	IMMO_LED (SECURITY INDICATOR)
50	LG/B	COMBI SW OUT 5
51	L/W	COMBI SW OUT 1
52	G/B	COMBI SW OUT 2
53	LG/R	COMBI SW OUT 3
53	G/Y	COMBI SW OUT 4
54	-	-
55	-	-
56	W	TPMS MODE
58	SB	DR DOOR SW
59	G/R	REAR DEFOGGER

ABMIA0177GB

# BCM (BODY CONTROL MODULE)

< ECU DIAGNOSIS >

Connector No.	M19
Connector Name	BCM (BODY CONTROL MODULE)
Connector Color	BLACK



79	78	77	76	75	74	73	72	71	70	69	68	67	66	65	64	63	62	61	60
----	----	----	----	----	----	----	----	----	----	----	----	----	----	----	----	----	----	----	----

Terminal No.	Color of Wire	Signal Name
60	B/R	ROOM ANT 2 B
61	W/R	ROOM ANT 2 A
62	V	AS DOOR ANT B
63	P	AS DOOR ANT A
64	V	DR DOOR ANT B
65	P	DR DOOR ANT A
66	R	ROOM ANT 1 B



100	101	102	103	104		
105	106	107	108	109	110	111

Terminal No.	Color of Wire	Signal Name
100	-	-
101	-	-
102	-	-
103	V	CDL BACK TRUNK

Terminal No.	Color of Wire	Signal Name
67	G	ROOM ANT 1 A
68	G/O	FOB READER CLOCK
69	O	FOB READER DATA
70	R/B	IGN REL OUTPUT 2
71	L/O	RF1 TUNER SIGNAL
72	-	-
73	-	-
74	-	-
75	R/Y	COMBI SW IN 5
76	R/G	COMBI SW IN 3
77	BR	ENG START SW
78	P	CAN-L
79	L	CAN-H
80	R/L	FOB SLOT ILLUMINATION
81	Y/L	IGN ON LED
82	-	-
83	L	ACC CONT

Terminal No.	Color of Wire	Signal Name
84	Y/R	AT DEVICE OUT
85	L/O	S/L CONDITION 1
86	G/R	S/L CONDITION 2
87	G/B	SHIFT P/ASCD CANCEL SW
88	R	AS REQUEST SW
89	R	DR REQUEST SW
90	Y	BLOWER FAN RELAY
91	L/R	RF POWER SUPPLY 12V
92	-	-
93	-	-
94	G/Y	S/L POWER SUPPLY 12V
95	R/W	COMBI SW IN 1
96	P/B	COMBI SW IN 4
97	R/B	COMBI SW IN 2
98	G/O	HAZARD SW
99	L/Y	S/L K-LINE

Terminal No.	Color of Wire	Signal Name
104	-	-
105	-	-
106	-	-
107	-	-
108	-	-
109	-	-
110	V/W	TRUNK LAMP CONT
111	-	-

Connector No.	M20
Connector Name	BCM (BODY CONTROL MODULE)
Connector Color	WHITE

ABMIA0178GB

A  
B  
C  
D  
E  
F  
G  
H  
I  
ADP  
K  
L  
M  
N  
O  
P

# BCM (BODY CONTROL MODULE)

< ECU DIAGNOSIS >

Terminal No.	Color of Wire	Signal Name
136	-	-
137	-	-
138	-	-
139	-	-
140	-	-
141	BR	TRUNK REQUEST SW
142	-	-
143	-	-
144	GR	BUZZER
145	-	-
146	-	-
147	L/R	BACK TRUNK OPENER
148	R/W	RR DOOR SW
149	R/B	RL DOOR SW
150	-	-
151	-	-

Terminal No.	Color of Wire	Signal Name
119	BR/W	BACK DOOR ANT A
120	-	-
121	-	-
122	-	-
123	-	-
124	-	-
125	-	-
126	-	-
127	BR/W	IGN RELAY OUTPUT
128	-	-
129	-	-
130	W	TRUNK SW
131	-	-
132	R	ST RELAY OUTPUT
133	-	-
134	-	-
135	-	-

Connector No.	M21
Connector Name	BCM (BODY CONTROL MODULE)
Connector Color	GRAY

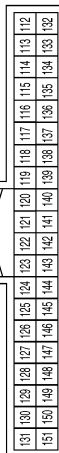

Terminal No.	Color of Wire	Signal Name
112	-	-
113	-	-
114	B	TRUNK ANT 1 B
115	W	TRUNK ANT 1 A
116	-	-
117	-	-
118	L/O	BACK DOOR ANT B

ABMIA0179GB

INFOID:000000004375881

## Fail Safe

Display contents of CONSULT	Fail-safe	Cancellation
B2013: ID DISCORD BCM-S/L	Inhibit engine cranking	Erase DTC
B2014: CHAIN OF S/L-BCM	Inhibit engine cranking	Erase DTC
B2190: NATS ANTENNA AMP	Inhibit engine cranking	Erase DTC

## BCM (BODY CONTROL MODULE)

### < ECU DIAGNOSIS >

Display contents of CONSULT	Fail-safe	Cancellation	
B2191: DIFFERENCE OF KEY	Inhibit engine cranking	Erase DTC	A
B2192: ID DISCORD BCM-ECM	Inhibit engine cranking	Erase DTC	
B2193: CHAIN OF BCM-ECM	Inhibit engine cranking	Erase DTC	B
B2195: ANTI-SCANNING	Inhibit engine cranking	Erase DTC	
B2557: VEHICLE SPEED	Inhibit electronic steering column lock	When normal vehicle speed signals have been received from ABS actuator and electric unit (control unit) for 500 ms	C
B2560: STARTER CONT RELAY	Inhibit engine cranking	500 ms after the following CAN signal communication status has become consistent <ul style="list-style-type: none"> <li>• Starter control relay signal</li> <li>• Starter relay status signal</li> </ul>	D
B2562: LO VOLTAGE	<ul style="list-style-type: none"> <li>• Inhibit engine cranking</li> <li>• Inhibit electronic steering column lock</li> </ul>	100 ms after the power supply voltage increases to more than 8.8 V	E
B2601: SHIFT POSITION	Inhibit electronic steering column lock	500 ms after the following signal reception status becomes consistent <ul style="list-style-type: none"> <li>• Selector lever P position switch signal</li> <li>• P range signal (CAN)</li> </ul>	F
B2602: SHIFT POSITION	Inhibit electronic steering column lock	5 seconds after the following BCM recognition conditions are fulfilled <ul style="list-style-type: none"> <li>• Ignition switch is in the ON position</li> <li>• Selector lever P position switch signal: Except P position (battery voltage)</li> <li>• Vehicle speed: 4 km/h or more</li> </ul>	G
B2603: SHIFT POSI STATUS	Inhibit electronic steering column lock	500 ms after the following BCM recognition conditions are fulfilled <ul style="list-style-type: none"> <li>• Ignition switch is in the ON position</li> <li>• Selector lever P position switch signal: Except P position (battery voltage)</li> <li>• Selector lever P/N position signal: Except P and N positions (0 V)</li> </ul>	H
B2604: PNP SW	Inhibit electronic steering column lock	500 ms after any of the following BCM recognition conditions is fulfilled <ul style="list-style-type: none"> <li>• Status 1               <ul style="list-style-type: none"> <li>- Ignition switch is in the ON position</li> <li>- Selector lever P/N position signal: P and N position (battery voltage)</li> <li>- P range signal or N range signal (CAN): ON</li> </ul> </li> <li>• Status 2               <ul style="list-style-type: none"> <li>- Ignition switch is in the ON position</li> <li>- Selector lever P/N position signal: Except P and N positions (0 V)</li> <li>- P range signal and N range signal (CAN): OFF</li> </ul> </li> </ul>	I <b>ADP</b>
B2605: PNP SW	Inhibit electronic steering column lock	500 ms after any of the following BCM recognition conditions is fulfilled <ul style="list-style-type: none"> <li>• Ignition switch is in the ON position               <ul style="list-style-type: none"> <li>- Power position: IGN</li> <li>- Selector lever P/N position signal: Except P and N positions (0 V)</li> <li>- Interlock/PNP switch signal (CAN): OFF</li> </ul> </li> <li>• Status 2               <ul style="list-style-type: none"> <li>- Ignition switch is in the ON position</li> <li>- Selector lever P/N position signal: P or N position (battery voltage)</li> <li>- PNP switch signal (CAN): ON</li> </ul> </li> </ul>	J K L
B2606: S/L RELAY	Inhibit engine cranking	500 ms after the following CAN signal communication status has become consistent <ul style="list-style-type: none"> <li>• Electronic steering column lock relay signal (Request signal)</li> <li>• Electronic steering column lock relay signal (Condition signal)</li> </ul>	M N O
B2607: S/L RELAY	Inhibit engine cranking	500 ms after the following CAN signal communication status has become consistent <ul style="list-style-type: none"> <li>• Electronic steering column lock relay signal (Request signal)</li> <li>• Electronic steering column lock relay signal (Condition signal)</li> </ul>	P

# BCM (BODY CONTROL MODULE)

## < ECU DIAGNOSIS >

Display contents of CONSULT	Fail-safe	Cancellation
B2608: STARTER RELAY	Inhibit engine cranking	500 ms after the following signal communication status becomes consistent <ul style="list-style-type: none"> <li>• Starter motor relay control signal</li> <li>• Starter relay status signal (CAN)</li> </ul>
B2609: S/L STATUS	<ul style="list-style-type: none"> <li>• Inhibit engine cranking</li> <li>• Inhibit electronic steering column lock</li> </ul>	When the following electronic steering column lock conditions agree <ul style="list-style-type: none"> <li>• BCM electronic steering column lock control status</li> <li>• Electronic steering column lock condition No. 1 signal status</li> <li>• Electronic steering column lock condition No. 2 signal status</li> </ul>
B260A: IGNITION RELAY	Inhibit engine cranking	500 ms after the following conditions are fulfilled <ul style="list-style-type: none"> <li>• IGN relay (IPDM E/R) control signal: OFF (Battery voltage)</li> <li>• Ignition ON signal (CAN to IPDM E/R): OFF (Request signal)</li> <li>• Ignition ON signal (CAN from IPDM E/R): OFF (Condition signal)</li> </ul>
B260F: ENG STATE SIG LOST	Maintains the power supply position attained at the time of DTC detection	When any of the following conditions is fulfilled <ul style="list-style-type: none"> <li>• Power position changes to ACC</li> <li>• Receives engine status signal (CAN)</li> </ul>
B2612: S/L STATUS	<ul style="list-style-type: none"> <li>• Inhibit engine cranking</li> <li>• Inhibit electronic steering column lock</li> </ul>	When any of the following conditions is fulfilled <ul style="list-style-type: none"> <li>• Electronic steering column lock unit status signal (CAN) is received normally</li> <li>• The BCM electronic steering column lock control status matches the electronic steering column lock status recognized by the electronic steering column lock unit status signal (CAN from IPDM E/R)</li> </ul>
B2617: STARTER RELAY CIRC	Inhibit engine cranking	1 second after the starter motor relay control inside BCM becomes normal
B2618: BCM	Inhibit engine cranking	1 second after the ignition relay (IPDM E/R) control inside BCM becomes normal
B2619: BCM	Inhibit engine cranking	1 second after the electronic steering column lock unit power supply output control inside BCM becomes normal
B26E1: ENG STATE NO RECIV	Inhibit engine cranking	When any of the following conditions are fulfilled <ul style="list-style-type: none"> <li>• Power position changes to ACC</li> <li>• Receives engine status signal (CAN)</li> </ul>

## DTC Inspection Priority Chart

INFOID:000000004375882

If some DTCs are displayed at the same time, perform inspections one by one based on the following priority chart.

Priority	DTC
1	<ul style="list-style-type: none"> <li>• B2562: LO VOLTAGE</li> </ul>
2	<ul style="list-style-type: none"> <li>• U1000: CAN COMM CIRCUIT</li> <li>• U1010: CONTROL UNIT (CAN)</li> </ul>
3	<ul style="list-style-type: none"> <li>• B2190: NATS ANTENNA AMP</li> <li>• B2191: DIFFERENCE OF KEY</li> <li>• B2192: ID DISCORD BCM-ECM</li> <li>• B2193: CHAIN OF BCM-ECM</li> </ul>



# BCM (BODY CONTROL MODULE)

## < ECU DIAGNOSIS >

Priority	DTC	A	
4	<ul style="list-style-type: none"> <li>• B2013: ID DISCORD BCM-S/L</li> <li>• B2014: CHAIN OF S/L-BCM</li> <li>• B2553: IGNITION RELAY</li> <li>• B2555: STOP LAMP</li> <li>• B2556: PUSH-BTN IGN SW</li> <li>• B2557: VEHICLE SPEED</li> <li>• B2560: STARTER CONT RELAY</li> <li>• B2601: SHIFT POSITION</li> <li>• B2602: SHIFT POSITION</li> <li>• B2603: SHIFT POSI STATUS</li> <li>• B2604: PNP SW</li> <li>• B2605: PNP SW</li> <li>• B2606: S/L RELAY</li> <li>• B2607: S/L RELAY</li> <li>• B2608: STARTER RELAY</li> <li>• B2609: S/L STATUS</li> <li>• B260A: IGNITION RELAY</li> <li>• B260B: STEERING LOCK UNIT</li> <li>• B260C: STEERING LOCK UNIT</li> <li>• B260D: STEERING LOCK UNIT</li> <li>• B260F: ENG STATE SIG LOST</li> <li>• B2612: S/L STATUS</li> <li>• B2614: ACC RELAY CIRC</li> <li>• B2615: BLOWER RELAY CIRC</li> <li>• B2616: IGN RELAY CIRC</li> <li>• B2617: STARTER RELAY CIRC</li> <li>• B2618: BCM</li> <li>• B2619: BCM</li> <li>• B261A: PUSH-BTN IGN SW</li> <li>• B26E1: ENG STATE NO RECIV</li> <li>• C1729: VHCL SPEED SIG ERR</li> <li>• U0415: VEHICLE SPEED SIG</li> </ul>	A B C D E F G H I	
	<ul style="list-style-type: none"> <li>• C1704: LOW PRESSURE FL</li> <li>• C1705: LOW PRESSURE FR</li> <li>• C1706: LOW PRESSURE RR</li> <li>• C1707: LOW PRESSURE RL</li> <li>• C1708: [NO DATA] FL</li> <li>• C1709: [NO DATA] FR</li> <li>• C1710: [NO DATA] RR</li> <li>• C1711: [NO DATA] RL</li> <li>• C1712: [CHECKSUM ERR] FL</li> <li>• C1713: [CHECKSUM ERR] FR</li> <li>• C1714: [CHECKSUM ERR] RR</li> <li>• C1715: [CHECKSUM ERR] RL</li> <li>• C1716: [PRESSDATA ERR] FL</li> <li>• C1717: [PRESSDATA ERR] FR</li> <li>• C1718: [PRESSDATA ERR] RR</li> <li>• C1719: [PRESSDATA ERR] RL</li> <li>• C1720: [CODE ERR] FL</li> <li>• C1721: [CODE ERR] FR</li> <li>• C1722: [CODE ERR] RR</li> <li>• C1723: [CODE ERR] RL</li> <li>• C1724: [BATT VOLT LOW] FL</li> <li>• C1725: [BATT VOLT LOW] FR</li> <li>• C1726: [BATT VOLT LOW] RR</li> <li>• C1727: [BATT VOLT LOW] RL</li> <li>• C1734: CONTROL UNIT</li> </ul>	ADP K L M N O P	
	5		
	6	<ul style="list-style-type: none"> <li>• B2621: INSIDE ANTENNA</li> <li>• B2622: INSIDE ANTENNA</li> <li>• B2623: INSIDE ANTENNA</li> </ul>	

DTC Index

INFOID:000000004375883

NOTE:

## BCM (BODY CONTROL MODULE)

### < ECU DIAGNOSIS >

Details of time display

- CRNT: Displays when there is a malfunction now or after returning to the normal condition until turning ignition switch OFF → ON again.
- 1 - 39: Displayed if any previous malfunction is present when current condition is normal. It increases 1 → 2 → 3...38 → 39 after returning to the normal condition whenever ignition switch OFF → ON. The counter remains at 39 even if the number of cycles exceeds it. It is counted from 1 again when turning ignition switch OFF → ON after returning to the normal condition if the malfunction is detected again.

CONSULT display	Fail-safe	Intelligent Key warning lamp ON	Tire pressure monitor warning lamp ON	Reference page
No DTC is detected. further testing may be required.	—	—	—	—
U1000: CAN COMM CIRCUIT	—	—	—	<a href="#">BCS-37</a>
U1010: CONTROL UNIT (CAN)	—	—	—	<a href="#">BCS-38</a>
U0415: VEHICLE SPEED SIG	—	—	—	<a href="#">BCS-39</a>
B2013: ID DISCORD BCM-S/L	×	—	—	<a href="#">SEC-30</a>
B2014: CHAIN OF S/L-BCM	×	—	—	<a href="#">SEC-31</a>
B2190: NATS ANTENNA AMP	×	—	—	<a href="#">SEC-34</a>
B2191: DIFFERENCE OF KEY	×	—	—	<a href="#">SEC-37</a>
B2192: ID DISCORD BCM-ECM	×	—	—	<a href="#">SEC-38</a>
B2193: CHAIN OF BCM-ECM	×	—	—	<a href="#">SEC-39</a>
B2553: IGNITION RELAY	—	—	—	<a href="#">PCS-54</a>
B2555: STOP LAMP	—	—	—	<a href="#">SEC-40</a>
B2556: PUSH-BTN IGN SW	—	×	—	<a href="#">SEC-42</a>
B2557: VEHICLE SPEED	×	×	—	<a href="#">SEC-44</a>
B2560: STARTER CONT RELAY	×	×	—	<a href="#">SEC-45</a>
B2562: LOW VOLTAGE	—	—	—	<a href="#">BCS-40</a>
B2601: SHIFT POSITION	×	×	—	<a href="#">SEC-46</a>
B2602: SHIFT POSITION	×	×	—	<a href="#">SEC-49</a>
B2603: SHIFT POSI STATUS	×	×	—	<a href="#">SEC-51</a>
B2604: PNP SW	×	×	—	<a href="#">SEC-54</a>
B2605: PNP SW	×	×	—	<a href="#">SEC-56</a>
B2606: S/L RELAY	×	×	—	<a href="#">SEC-58</a>
B2607: S/L RELAY	×	×	—	<a href="#">SEC-59</a>
B2608: STARTER RELAY	×	×	—	<a href="#">SEC-61</a>
B2609: S/L STATUS	×	×	—	<a href="#">SEC-63</a>
B260A: IGNITION RELAY	×	×	—	<a href="#">PCS-56</a>
B260B: STEERING LOCK UNIT	—	×	—	<a href="#">SEC-67</a>
B260C: STEERING LOCK UNIT	—	×	—	<a href="#">SEC-68</a>
B260D: STEERING LOCK UNIT	—	×	—	<a href="#">SEC-69</a>
B260F: ENG STATE SIG LOST	×	×	—	<a href="#">SEC-70</a>
B2612: S/L STATUS	×	×	—	<a href="#">SEC-72</a>
B2614: ACC RELAY CIRC	—	×	—	<a href="#">PCS-58</a>
B2615: BLOWER RELAY CIRC	—	×	—	<a href="#">PCS-61</a>
B2616: IGN RELAY CIRC	—	×	—	<a href="#">PCS-64</a>
B2617: STARTER RELAY CIRC	×	×	—	<a href="#">PCS-64</a>
B2618: BCM	×	×	—	<a href="#">PCS-67</a>

## BCM (BODY CONTROL MODULE)

### < ECU DIAGNOSIS >

CONSULT display	Fail-safe	Intelligent Key warning lamp ON	Tire pressure monitor warning lamp ON	Reference page	
B2619: BCM	×	×	—	<a href="#">SEC-78</a>	A
B261A: PUSH-BTN IGN SW	—	×	—	<a href="#">SEC-79</a>	B
B2621: INSIDE ANTENNA	—	—	—	<a href="#">DLK-57</a>	
B2622: INSIDE ANTENNA	—	—	—	<a href="#">DLK-60</a>	C
B2623: INSIDE ANTENNA	—	—	—	<a href="#">DLK-63</a>	
B26E1: ENG STATE NO RES	×	×	—	<a href="#">SEC-71</a>	
C1704: LOW PRESSURE FL	—	—	×	<a href="#">WT-48</a>	D
C1705: LOW PRESSURE FR	—	—	×	<a href="#">WT-48</a>	
C1706: LOW PRESSURE RR	—	—	×	<a href="#">WT-48</a>	E
C1707: LOW PRESSURE RL	—	—	×	<a href="#">WT-48</a>	
C1708: [NO DATA] FL	—	—	×	<a href="#">WT-13</a>	F
C1709: [NO DATA] FR	—	—	×	<a href="#">WT-13</a>	
C1710: [NO DATA] RR	—	—	×	<a href="#">WT-13</a>	G
C1711: [NO DATA] RL	—	—	×	<a href="#">WT-13</a>	
C1712: [CHECKSUM ERR] FL	—	—	×	<a href="#">WT-15</a>	H
C1713: [CHECKSUM ERR] FR	—	—	×	<a href="#">WT-15</a>	
C1714: [CHECKSUM ERR] RR	—	—	×	<a href="#">WT-15</a>	I
C1715: [CHECKSUM ERR] RL	—	—	×	<a href="#">WT-15</a>	
C1716: [PRESSDATA ERR] FL	—	—	×	<a href="#">WT-17</a>	ADP
C1717: [PRESSDATA ERR] FR	—	—	×	<a href="#">WT-17</a>	
C1718: [PRESSDATA ERR] RR	—	—	×	<a href="#">WT-17</a>	K
C1719: [PRESSDATA ERR] RL	—	—	×	<a href="#">WT-17</a>	
C1720: [CODE ERR] FL	—	—	×	<a href="#">WT-15</a>	L
C1721: [CODE ERR] FR	—	—	×	<a href="#">WT-15</a>	
C1722: [CODE ERR] RR	—	—	×	<a href="#">WT-15</a>	M
C1723: [CODE ERR] RL	—	—	×	<a href="#">WT-15</a>	
C1724: [BATT VOLT LOW] FL	—	—	×	<a href="#">WT-15</a>	N
C1725: [BATT VOLT LOW] FR	—	—	×	<a href="#">WT-15</a>	
C1726: [BATT VOLT LOW] RR	—	—	×	<a href="#">WT-15</a>	O
C1727: [BATT VOLT LOW] RL	—	—	×	<a href="#">WT-15</a>	
C1729: VHCL SPEED SIG ERR	—	—	×	<a href="#">WT-18</a>	P
C1734: CONTROL UNIT	—	—	×	<a href="#">WT-19</a>	

# ADP SYSTEM SYMPTOMS

< SYMPTOM DIAGNOSIS >

## SYMPTOM DIAGNOSIS

### ADP SYSTEM SYMPTOMS

#### Symptom Table

INFOID:000000003900390

**NOTE:**

Always perform the “Basic Inspection” before performing diagnosis in the following table. Refer to [ADP-5](#), “[Work Flow](#)”.

#### SYMPTOM 1

Symptom	Diagnosis procedure	Reference page
Manual functions (for specific part) do not operate	Sliding operation	Check sliding switch. <a href="#">ADP-48</a>
	Reclining operation	Check reclining switch. <a href="#">ADP-50</a>
	Lifting operation (front)	Check lifting switch (front). <a href="#">ADP-52</a>
	Lifting operation (rear)	Check lifting switch (rear). <a href="#">ADP-54</a>
	Tilt operation	Check tilt switch. <a href="#">ADP-56</a>
	Telescopic sensor	Check telescopic switch. <a href="#">ADP-58</a>
	Door mirror operation	1. Changeover switch. <a href="#">ADP-62</a>
		2. Mirror switch <a href="#">ADP-64</a>
All parts of seat	Check power seat switch ground circuit. <a href="#">ADP-68</a>	

#### SYMPTOM 2

Symptom	Diagnosis procedure	Reference page
Memory functions (for specific part) do not operate	Sliding operation	Check sliding sensor. <a href="#">ADP-72</a>
	Reclining operation	Check reclining sensor. <a href="#">ADP-75</a>
	Lifting operation (front)	Check lifting sensor (front). <a href="#">ADP-78</a>
	Lifting operation (rear)	Check lifting sensor (rear). <a href="#">ADP-81</a>
	Tilt operation	Check tilt sensor. <a href="#">ADP-84</a>
	Telescopic operation	Check telescopic sensor. <a href="#">ADP-87</a>
	Door mirror operation	Check door mirror sensor. Driver side: <a href="#">ADP-90</a> Passenger side: <a href="#">ADP-92</a>

#### SYMPTOM 3

Symptom	Diagnosis procedure	Reference page
Memory functions and manual functions (for specific part) do not operate	Sliding operation	Check sliding motor. <a href="#">ADP-95</a>
	Reclining operation	Check reclining motor. <a href="#">ADP-97</a>
	Lifting operation (front)	Check lifting motor (front). <a href="#">ADP-99</a>
	Lifting operation (rear)	Check lifting motor (rear). <a href="#">ADP-101</a>
	Tilt operation	Check tilt motor. <a href="#">ADP-103</a>
	Telescopic operation	Check telescopic motor. <a href="#">ADP-105</a>
	Door mirror operation	Check door mirror motor. <a href="#">ADP-107</a>

# ADP SYSTEM SYMPTOMS

## < SYMPTOM DIAGNOSIS >

### SYMPTOM 4

Symptom	Diagnosis procedure	Reference page
Entry/Exit assist function does not operate.	1. Check system setting.	<a href="#">ADP-22</a>
	2. Perform initialization.	<a href="#">ADP-25</a>
	3. Check front door switch (driver side).	<a href="#">ADP-70</a>
Intelligent Key interlock function does not operate. (Other automatic operations and Intelligent Key system are normal)	1. Check door lock function.	<a href="#">DLK-13</a>
	2. Perform memory storing.	<a href="#">ADP-8</a>

### SYMPTOM 5

Symptom	Diagnosis procedure	Reference page
Memory indicators 1 and/or 2 do not illuminate.	1. Check seat memory switch.	<a href="#">ADP-60</a>
	2. Check seat memory indicator.	<a href="#">ADP-110</a>

A

B

C

D

E

F

G

H

I

ADP

K

L

M

N

O

P

## NORMAL OPERATING CONDITION

< SYMPTOM DIAGNOSIS >

### NORMAL OPERATING CONDITION

#### Description

INFOID:000000003900391

The following symptoms are normal operations, and they do not indicate a malfunction.

Symptom	Cause	Action to take	Reference page
Entry/Exit assist function does not operate.	No initialization has been performed.	Perform initialization.	<a href="#">ADP-22</a>
	Entry/exit assist function is disabled. <b>NOTE:</b> The entry/exit assist function is disabled before delivery (initial setting).	Change the settings.	<a href="#">ADP-26</a>
Entry assist function does not operate.	Manual operation with power seat switch was performed after exit assist function execution.	Perform the memory function.	<a href="#">ADP-26</a>
Memory function, entry/exit assist function or Intelligent Key interlock function does not operate.	The operating conditions are not fulfilled.	Fulfill the operation conditions.	Memory function: <a href="#">ADP-18</a>
			Exit assist function: <a href="#">ADP-22</a>
			Entry assist function: <a href="#">ADP-26</a>
			Intelligent Key interlock function: <a href="#">ADP-30</a>

# PRECAUTIONS

< PRECAUTION >

## PRECAUTION

### PRECAUTIONS

#### Precaution for Supplemental Restraint System (SRS) "AIR BAG" and "SEAT BELT PRE-TENSIONER"

INFOID:000000003900392

The Supplemental Restraint System such as "AIR BAG" and "SEAT BELT PRE-TENSIONER", used along with a front seat belt, helps to reduce the risk or severity of injury to the driver and front passenger for certain types of collision. This system includes seat belt switch inputs and dual stage front air bag modules. The SRS system uses the seat belt switches to determine the front air bag deployment, and may only deploy one front air bag, depending on the severity of a collision and whether the front occupants are belted or unbelted. Information necessary to service the system safely is included in the SR and SB section of this Service Manual.

#### **WARNING:**

- To avoid rendering the SRS inoperative, which could increase the risk of personal injury or death in the event of a collision which would result in air bag inflation, all maintenance must be performed by an authorized NISSAN/INFINITI dealer.
- Improper maintenance, including incorrect removal and installation of the SRS, can lead to personal injury caused by unintentional activation of the system. For removal of Spiral Cable and Air Bag Module, see the SR section.
- Do not use electrical test equipment on any circuit related to the SRS unless instructed to in this Service Manual. SRS wiring harnesses can be identified by yellow and/or orange harnesses or harness connectors.

#### Precautions Necessary for Steering Wheel Rotation after Battery Disconnect

INFOID:000000004394048

#### **NOTE:**

- Before removing and installing any control units, first turn the push-button ignition switch to the LOCK position, then disconnect both battery cables.
- After finishing work, confirm that all control unit connectors are connected properly, then re-connect both battery cables.
- Always use CONSULT-III to perform self-diagnosis as a part of each function inspection after finishing work. If a DTC is detected, perform trouble diagnosis according to self-diagnosis results.

This vehicle is equipped with a push-button ignition switch and a steering lock unit.

If the battery is disconnected or discharged, the steering wheel will lock and cannot be turned.

If turning the steering wheel is required with the battery disconnected or discharged, follow the procedure below before starting the repair operation.

#### OPERATION PROCEDURE

1. Connect both battery cables.

#### **NOTE:**

Supply power using jumper cables if battery is discharged.

2. Carry the Intelligent Key or insert it to the key slot and turn the push-button ignition switch to ACC position. (At this time, the steering lock will be released.)
3. Disconnect both battery cables. The steering lock will remain released with both battery cables disconnected and the steering wheel can be turned.
4. Perform the necessary repair operation.
5. When the repair work is completed, re-connect both battery cables. With the brake pedal released, turn the push-button ignition switch from ACC position to ON position, then to LOCK position. (The steering wheel will lock when the push-button ignition switch is turned to LOCK position.)
6. Perform self-diagnosis check of all control units using CONSULT-III.

#### Precaution for Work

INFOID:000000003900393

- When removing or disassembling each component, be careful not to damage or deform it. If a component may be subject to interference, be sure to protect it with a shop cloth.
- When removing (disengaging) components with a screwdriver or similar tool, be sure to wrap the component with a shop cloth or vinyl tape to protect it.

A  
B  
C  
D  
E  
F  
G  
H  
I  
K  
L  
M  
N  
O  
P

ADP

## PRECAUTIONS

### < PRECAUTION >

---

- Protect the removed parts with a shop cloth and keep them.
- Replace a deformed or damaged clip.
- If a part is specified as a non-reusable part, always replace it with new one.
- Be sure to tighten bolts and nuts securely to the specified torque.
- After re-installation is completed, be sure to check that each part works normally.
- Follow the steps below to clean components.
- Water soluble foul: Dip a soft cloth into lukewarm water, and wring the water out of the cloth to wipe the fouled area.  
Then rub with a soft and dry cloth.
- Oily foul: Dip a soft cloth into lukewarm water with mild detergent (concentration: within 2 to 3%), and wipe the fouled area.  
Then dip a cloth into fresh water, and wring the water out of the cloth to wipe the detergent off. Then rub with a soft and dry cloth.
- Do not use organic solvent such as thinner, benzene, alcohol, or gasoline.
- For genuine leather seats, use a genuine leather seat cleaner.



# DRIVER SEAT CONTROL UNIT

< ON-VEHICLE REPAIR >

## ON-VEHICLE REPAIR

### DRIVER SEAT CONTROL UNIT

#### Removal and Installation

INFOID:000000004193566

**CAUTION:**

**When removing and installing, use shop cloths to protect parts from damage.**

#### REMOVAL

**NOTE:**

The driver seat control unit is part of the driver seat.

For removal of the driver seat control unit, refer to [SE-64. "Removal and Installation"](#) (with climate controlled seats), [SE-106. "Removal and Installation"](#) (without climate controlled seats).

#### INSTALLATION

Installation is in the reverse order of removal.

**CAUTION:**

**Be sure to install the harness in the right place.**

**NOTE:**

After installing the driver seat, perform additional service when replacing control unit. Refer to [ADP-8. "Special Repair Requirement"](#).

A  
B  
C  
D  
E  
F  
G  
H  
I  
K  
L  
M  
N  
O  
P

ADP

# AUTOMATIC DRIVE POSITIONER CONTROL UNIT

< ON-VEHICLE REPAIR >

## AUTOMATIC DRIVE POSITIONER CONTROL UNIT

### Removal and Installation

INFOID:000000004193568

#### **CAUTION:**

**When removing and installing, use shop cloths to protect parts from damage.**

#### REMOVAL

1. Remove cluster lid D from instrument panel. Refer to [IP-12, "Removal and Installation"](#).
2. Remove audio unit. Refer to [AV-64, "Removal and Installation"](#).
3. Remove the screw (A).
4. Remove automatic drive positioner control unit (1).

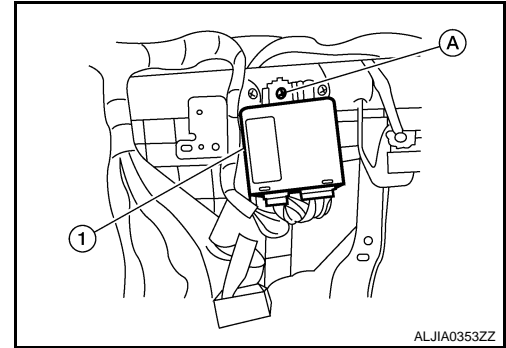

#### INSTALLATION

Installation is in the reverse order of removal.

#### **CAUTION:**

**Be sure to install the harness in the right place.**

# SEAT MEMORY SWITCH

< ON-VEHICLE REPAIR >

## SEAT MEMORY SWITCH

### Removal and Installation

INFOID:000000004193570

#### **CAUTION:**

**When removing and installing, use shop cloths to protect parts from damage.**

#### REMOVAL

1. Remove the seat memory finisher (1). Refer to [INT-18, "Removal and Installation"](#).
2. Press pawls and remove seat memory switch (2) from seat memory finisher (1).

 : Pawl

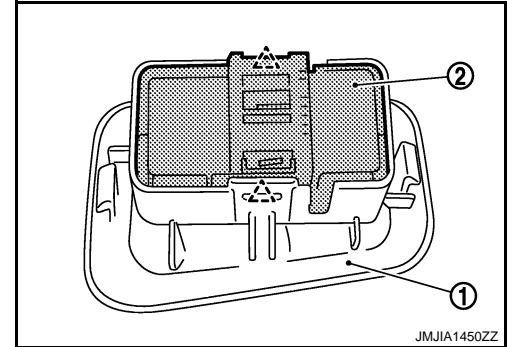

#### INSTALLATION

Installation is in the reverse order of removal.

#### **CAUTION:**

**Be sure to install the harness in the right place.**

A  
B  
C  
D  
E  
F  
G  
H  
I  
K  
L  
M  
N  
O  
P

ADP

# TILT&TELESCOPIC SWITCH

< ON-VEHICLE REPAIR >

## TILT&TELESCOPIC SWITCH

### Removal and Installation

INFOID:000000004193574

#### **CAUTION:**

**When removing and installing, use shop cloths to protect parts from damage.**

#### REMOVAL

1. Remove the steering column cover (1). Refer to [IP-12, "Removal and Installation"](#).
2. Press pawls and remove tilt & telescopic switch (2) from the steering column mask (1).

 : Pawl

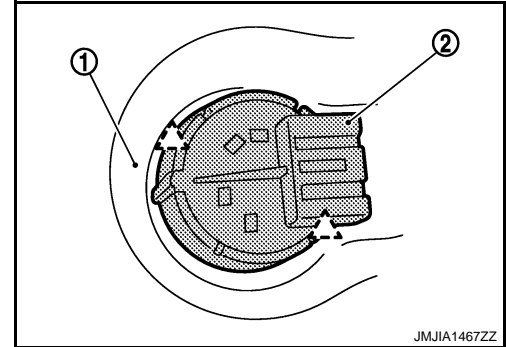

#### INSTALLATION

Installation is in the reverse order of removal.

#### **CAUTION:**

**Be sure to install the harness in the right place.**