

SECTION **LAN**
LAN SYSTEM

A
B
C
D
E
F
G
H
I
J
K
L

CONTENTS

CAN FUNDAMENTAL		PRECAUTIONS	21
PRECAUTION	5	Precaution for Supplemental Restraint System (SRS) "AIR BAG" and "SEAT BELT PRE-TENSIONER"	21
PRECAUTIONS	5	Precautions Necessary for Steering Wheel Rotation after Battery Disconnect (Early Production, With Electronic Steering Column Lock)	21
Precautions for Trouble Diagnosis	5	Precautions for Trouble Diagnosis	22
Precautions for Harness Repair	5	Precautions for Harness Repair	22
SYSTEM DESCRIPTION	6	BASIC INSPECTION	23
CAN COMMUNICATION SYSTEM	6	DIAGNOSIS AND REPAIR WORKFLOW	23
System Description	6	Interview Sheet	23
System Diagram	6	SYSTEM DESCRIPTION	24
CAN Communication Control Circuit	7	CAN COMMUNICATION SYSTEM	24
DIAG ON CAN	8	CAN System Specification Chart	24
Description	8	CAN Communication Signal Chart	24
System Diagram	8	WIRING DIAGRAM	28
TROUBLE DIAGNOSIS	9	CAN SYSTEM	28
Condition of Error Detection	9	Wiring Diagram	28
Symptom When Error Occurs in CAN Communication System	9	DTC/CIRCUIT DIAGNOSIS	36
CAN Diagnosis with CONSULT-III	12	CAN COMMUNICATION SYSTEM	36
Self-Diagnosis	12	Component Parts Location	36
CAN Diagnostic Support Monitor	12	MALFUNCTION AREA CHART	37
How to Use CAN Communication Signal Chart	14	Main Line	37
BASIC INSPECTION	15	Branch Line	37
DIAGNOSIS AND REPAIR WORKFLOW	15	Short Circuit	37
Trouble Diagnosis Flow Chart	15	MAIN LINE BETWEEN ADP AND DLC CIRCUIT	38
Trouble Diagnosis Procedure	15	Diagnosis Procedure	38
CAN		MAIN LINE BETWEEN DLC AND HVAC CIRCUIT	39
HOW TO USE THIS MANUAL	20	Diagnosis Procedure	39
HOW TO USE THIS SECTION	20		
Caution	20		
Abbreviation List	20		
PRECAUTION	21		

LAN

N
O
P

MAIN LINE BETWEEN HVAC AND ABS CIRCUIT	40
Diagnosis Procedure	40
MAIN LINE BETWEEN HVAC AND A-BAG CIRCUIT	41
Diagnosis Procedure	41
MAIN LINE BETWEEN A-BAG AND ABS CIRCUIT	42
Diagnosis Procedure	42
ECM BRANCH LINE CIRCUIT	43
Diagnosis Procedure	43
ADP BRANCH LINE CIRCUIT	44
Diagnosis Procedure	44
BCM BRANCH LINE CIRCUIT	45
Diagnosis Procedure	45
DLC BRANCH LINE CIRCUIT	46
Diagnosis Procedure	46
M&A BRANCH LINE CIRCUIT	47
Diagnosis Procedure	47
AV BRANCH LINE CIRCUIT	48
Diagnosis Procedure	48
HVAC BRANCH LINE CIRCUIT	49
Diagnosis Procedure	49
STRG BRANCH LINE CIRCUIT	50
Diagnosis Procedure	50
A-BAG BRANCH LINE CIRCUIT	51
Diagnosis Procedure	51
ABS BRANCH LINE CIRCUIT	52
Diagnosis Procedure	52
TCM BRANCH LINE CIRCUIT	53
Diagnosis Procedure	53
IPDM-E BRANCH LINE CIRCUIT	54
Diagnosis Procedure	54
CAN COMMUNICATION CIRCUIT	55
Diagnosis Procedure	55
CAN SYSTEM (TYPE 1)	
DTC/CIRCUIT DIAGNOSIS	57
MAIN LINE BETWEEN DLC AND HVAC CIRCUIT	57
Diagnosis Procedure	57
MAIN LINE BETWEEN HVAC AND A-BAG CIRCUIT	58
Diagnosis Procedure	58

MAIN LINE BETWEEN A-BAG AND ABS CIRCUIT	59
Diagnosis Procedure	59
ECM BRANCH LINE CIRCUIT	60
Diagnosis Procedure	60
BCM BRANCH LINE CIRCUIT	61
Diagnosis Procedure	61
DLC BRANCH LINE CIRCUIT	62
Diagnosis Procedure	62
M&A BRANCH LINE CIRCUIT	63
Diagnosis Procedure	63
HVAC BRANCH LINE CIRCUIT	64
Diagnosis Procedure	64
STRG BRANCH LINE CIRCUIT	65
Diagnosis Procedure	65
A-BAG BRANCH LINE CIRCUIT	66
Diagnosis Procedure	66
ABS BRANCH LINE CIRCUIT	67
Diagnosis Procedure	67
TCM BRANCH LINE CIRCUIT	68
Diagnosis Procedure	68
IPDM-E BRANCH LINE CIRCUIT	69
Diagnosis Procedure	69
CAN COMMUNICATION CIRCUIT	70
Diagnosis Procedure	70
CAN SYSTEM (TYPE 2)	
DTC/CIRCUIT DIAGNOSIS	72
MAIN LINE BETWEEN ADP AND DLC CIRCUIT	72
Diagnosis Procedure	72
MAIN LINE BETWEEN DLC AND HVAC CIRCUIT	73
Diagnosis Procedure	73
MAIN LINE BETWEEN HVAC AND A-BAG CIRCUIT	74
Diagnosis Procedure	74
MAIN LINE BETWEEN A-BAG AND ABS CIRCUIT	75
Diagnosis Procedure	75
ECM BRANCH LINE CIRCUIT	76
Diagnosis Procedure	76
ADP BRANCH LINE CIRCUIT	77
Diagnosis Procedure	77
BCM BRANCH LINE CIRCUIT	78

Diagnosis Procedure	78	Diagnosis Procedure	98	A
DLC BRANCH LINE CIRCUIT	79	A-BAG BRANCH LINE CIRCUIT	99	B
Diagnosis Procedure	79	Diagnosis Procedure	99	
M&A BRANCH LINE CIRCUIT	80	ABS BRANCH LINE CIRCUIT	100	B
Diagnosis Procedure	80	Diagnosis Procedure	100	
HVAC BRANCH LINE CIRCUIT	81	TCM BRANCH LINE CIRCUIT	101	C
Diagnosis Procedure	81	Diagnosis Procedure	101	
STRG BRANCH LINE CIRCUIT	82	IPDM-E BRANCH LINE CIRCUIT	102	D
Diagnosis Procedure	82	Diagnosis Procedure	102	
A-BAG BRANCH LINE CIRCUIT	83	CAN COMMUNICATION CIRCUIT	103	E
Diagnosis Procedure	83	Diagnosis Procedure	103	
ABS BRANCH LINE CIRCUIT	84	CAN SYSTEM (TYPE 4)		E
Diagnosis Procedure	84	DTC/CIRCUIT DIAGNOSIS	105	F
TCM BRANCH LINE CIRCUIT	85	MAIN LINE BETWEEN ADP AND DLC CIR-		F
Diagnosis Procedure	85	CUIT	105	
IPDM-E BRANCH LINE CIRCUIT	86	Diagnosis Procedure	105	G
Diagnosis Procedure	86	MAIN LINE BETWEEN DLC AND HVAC CIR-		
CAN COMMUNICATION CIRCUIT	87	CUIT	106	H
Diagnosis Procedure	87	Diagnosis Procedure	106	
CAN SYSTEM (TYPE 3)		MAIN LINE BETWEEN HVAC AND A-BAG		
DTC/CIRCUIT DIAGNOSIS	89	CIRCUIT	107	I
MAIN LINE BETWEEN DLC AND HVAC CIR-		Diagnosis Procedure	107	
CUIT	89	MAIN LINE BETWEEN A-BAG AND ABS		
Diagnosis Procedure	89	CIRCUIT	108	J
MAIN LINE BETWEEN HVAC AND A-BAG		Diagnosis Procedure	108	
CIRCUIT	90	ECM BRANCH LINE CIRCUIT	109	K
Diagnosis Procedure	90	Diagnosis Procedure	109	
MAIN LINE BETWEEN A-BAG AND ABS		ADP BRANCH LINE CIRCUIT	110	L
CIRCUIT	91	Diagnosis Procedure	110	
Diagnosis Procedure	91	BCM BRANCH LINE CIRCUIT	111	LAN
ECM BRANCH LINE CIRCUIT	92	Diagnosis Procedure	111	
Diagnosis Procedure	92	DLC BRANCH LINE CIRCUIT	112	N
BCM BRANCH LINE CIRCUIT	93	Diagnosis Procedure	112	
Diagnosis Procedure	93	M&A BRANCH LINE CIRCUIT	113	O
DLC BRANCH LINE CIRCUIT	94	Diagnosis Procedure	113	
Diagnosis Procedure	94	AV BRANCH LINE CIRCUIT	114	O
M&A BRANCH LINE CIRCUIT	95	Diagnosis Procedure	114	
Diagnosis Procedure	95	HVAC BRANCH LINE CIRCUIT	115	P
AV BRANCH LINE CIRCUIT	96	Diagnosis Procedure	115	
Diagnosis Procedure	96	STRG BRANCH LINE CIRCUIT	116	
HVAC BRANCH LINE CIRCUIT	97	Diagnosis Procedure	116	
Diagnosis Procedure	97	A-BAG BRANCH LINE CIRCUIT	117	
STRG BRANCH LINE CIRCUIT	98	Diagnosis Procedure	117	

ABS BRANCH LINE CIRCUIT	118	CAN COMMUNICATION CIRCUIT	134
Diagnosis Procedure	118	Diagnosis Procedure	134
TCM BRANCH LINE CIRCUIT	119	CAN SYSTEM (TYPE 6)	
Diagnosis Procedure	119	DTC/CIRCUIT DIAGNOSIS	136
IPDM-E BRANCH LINE CIRCUIT	120	MAIN LINE BETWEEN ADP AND DLC CIR-	
Diagnosis Procedure	120	CUIT	136
CAN COMMUNICATION CIRCUIT	121	Diagnosis Procedure	136
Diagnosis Procedure	121	MAIN LINE BETWEEN DLC AND HVAC CIR-	
CAN SYSTEM (TYPE 5)		CUIT	137
DTC/CIRCUIT DIAGNOSIS	123	Diagnosis Procedure	137
MAIN LINE BETWEEN DLC AND HVAC CIR-		MAIN LINE BETWEEN HVAC AND ABS CIR-	
CUIT	123	CUIT	138
Diagnosis Procedure	123	Diagnosis Procedure	138
MAIN LINE BETWEEN HVAC AND ABS CIR-		ECM BRANCH LINE CIRCUIT	139
CUIT	124	Diagnosis Procedure	139
Diagnosis Procedure	124	ADP BRANCH LINE CIRCUIT	140
ECM BRANCH LINE CIRCUIT	125	Diagnosis Procedure	140
Diagnosis Procedure	125	BCM BRANCH LINE CIRCUIT	141
BCM BRANCH LINE CIRCUIT	126	Diagnosis Procedure	141
Diagnosis Procedure	126	DLC BRANCH LINE CIRCUIT	142
DLC BRANCH LINE CIRCUIT	127	Diagnosis Procedure	142
Diagnosis Procedure	127	M&A BRANCH LINE CIRCUIT	143
M&A BRANCH LINE CIRCUIT	128	Diagnosis Procedure	143
Diagnosis Procedure	128	HVAC BRANCH LINE CIRCUIT	144
HVAC BRANCH LINE CIRCUIT	129	Diagnosis Procedure	144
Diagnosis Procedure	129	STRG BRANCH LINE CIRCUIT	145
STRG BRANCH LINE CIRCUIT	130	Diagnosis Procedure	145
Diagnosis Procedure	130	ABS BRANCH LINE CIRCUIT	146
ABS BRANCH LINE CIRCUIT	131	Diagnosis Procedure	146
Diagnosis Procedure	131	TCM BRANCH LINE CIRCUIT	147
TCM BRANCH LINE CIRCUIT	132	Diagnosis Procedure	147
Diagnosis Procedure	132	IPDM-E BRANCH LINE CIRCUIT	148
IPDM-E BRANCH LINE CIRCUIT	133	Diagnosis Procedure	148
Diagnosis Procedure	133	CAN COMMUNICATION CIRCUIT	149
		Diagnosis Procedure	149

PRECAUTION

PRECAUTIONS

Precautions for Trouble Diagnosis

INFOID:000000006234254

CAUTION:

- Never apply 7.0 V or more to the measurement terminal.
- Use a tester with open terminal voltage of 7.0 V or less.
- Turn the ignition switch OFF and disconnect the battery cable from the negative terminal when checking the harness.

Precautions for Harness Repair

INFOID:000000006234255

- Solder the repaired area and wrap tape around the soldered area.

NOTE:

A fray of twisted lines must be within 110 mm (4.33 in).

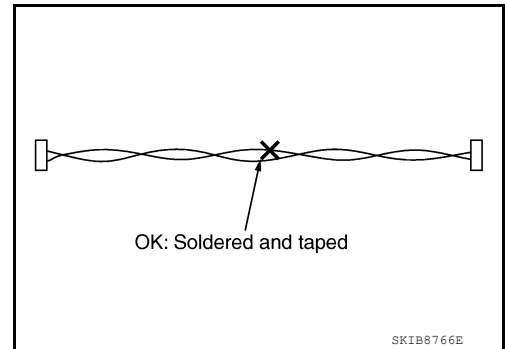

- Bypass connection is never allowed at the repaired area.

NOTE:

Bypass connection may cause CAN communication error. The spliced wire becomes separated and the characteristics of twisted line are lost.

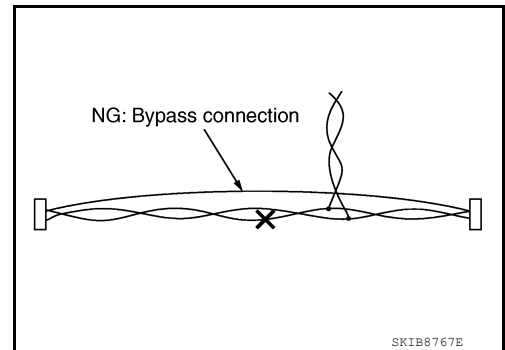

- Replace the applicable harness as an assembly if error is detected on the shield lines of CAN communication line.

A
B
C
D
E
F
G
H
I
J
K
L

LAN

SYSTEM DESCRIPTION

CAN COMMUNICATION SYSTEM

System Description

INFOID:000000006234256

- CAN communication is a multiplex communication system. This enables the system to transmit and receive large quantities of data at high speed by connecting control units with two communication lines (CAN-H and CAN-L).
- Control units on the CAN network transmit signals using the CAN communication control circuit. They receive only necessary signals from other control units to operate various functions.
- CAN communication lines adopt twisted-pair line style (two lines twisted) for noise immunity.

System Diagram

INFOID:000000006234257

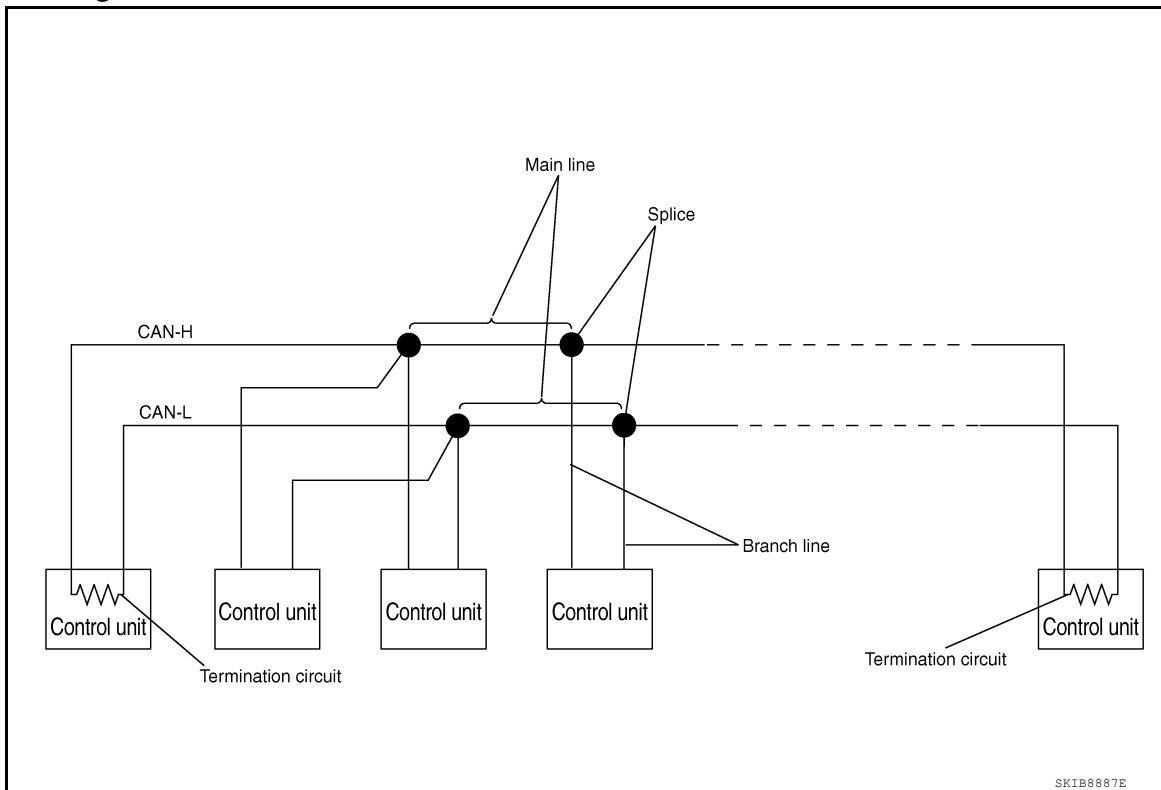

Each control unit passes an electric current to the termination circuits when transmitting CAN communication signal. The termination circuits produce an electrical potential difference between CAN-H and CAN-L. CAN communication system transmits and receives CAN communication signals by the potential difference.

Component	Description
Main line	CAN communication line between splices
Branch line	CAN communication line between splice and a control unit
Splice	A point connecting a branch line with a main line
Termination circuit	Refer to LAN-7, "CAN Communication Control Circuit" .

CAN COMMUNICATION SYSTEM

< SYSTEM DESCRIPTION >

[CAN FUNDAMENTAL]

CAN Communication Control Circuit

INFOID:000000006234258

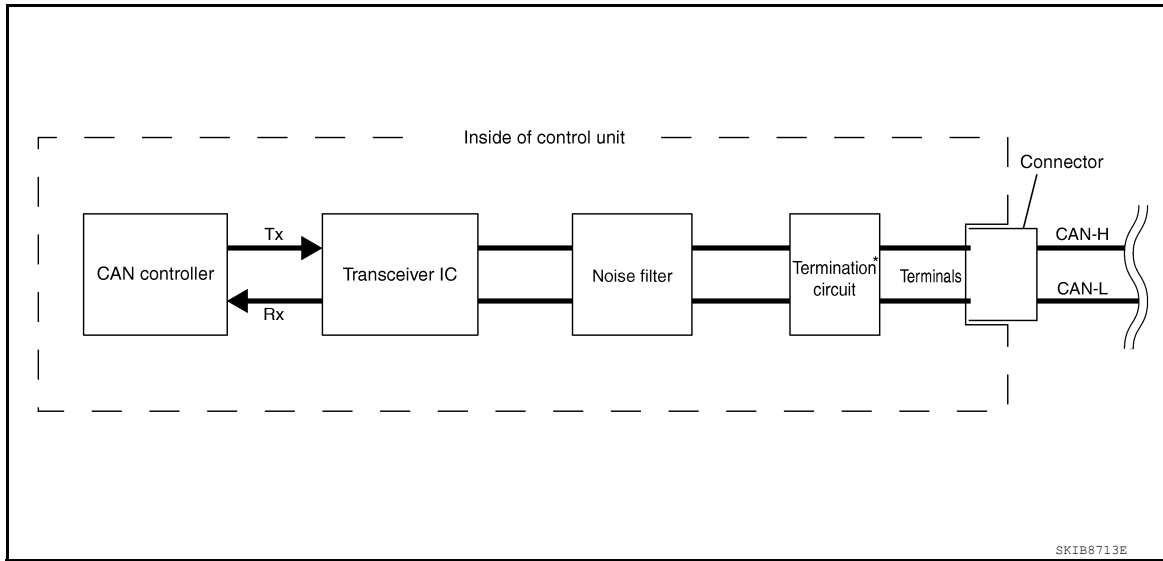

Component	System description
CAN controller	It controls CAN communication signal transmission and reception, error detection, etc.
Transceiver IC	It converts digital signal into CAN communication signal, and CAN communication signal into digital signal.
Noise filter	It eliminates noise of CAN communication signal.
Termination circuit* (Resistance of approx. 120 Ω)	It produces potential difference.

*: These are the only control units wired with both ends of CAN communication system.

A
B
C
D
E
F
G
H
I
J
K
L

LAN

N
O
P

DIAG ON CAN

Description

INFOID:000000006234259

“Diag on CAN” is a diagnosis using CAN communication instead of previous DDL1 and DDL2 communication lines, between control units and diagnosis unit.

System Diagram

INFOID:000000006234260

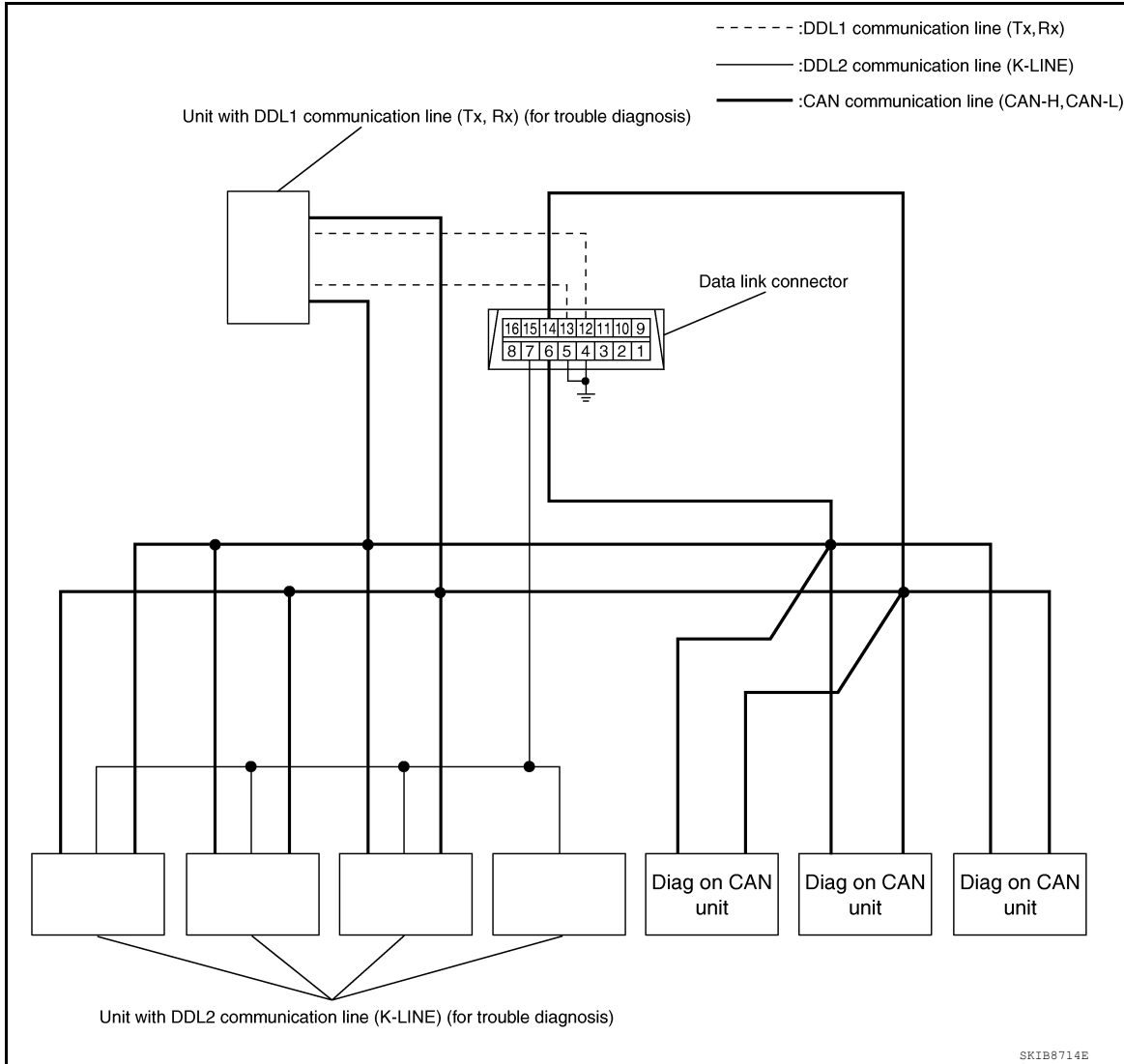

Name	Harness	Description
DDL1	Tx Rx	It is used for trouble diagnosis. (CAN-H and CAN-L are used for controlling)
DDL2	K-LINE	It is used for trouble diagnosis. (CAN-H and CAN-L are used for controlling)
Diag on CAN	CAN-H CAN-L	It is used for trouble diagnosis and control.

TROUBLE DIAGNOSIS

Condition of Error Detection

INFOID:000000006538824

DTC (e.g. U1000 and U1001) of CAN communication is indicated on SELF-DIAG RESULTS on CONSULT-III if a CAN communication signal is not transmitted or received between units for 2 seconds or more.

CAN COMMUNICATION SYSTEM ERROR

- CAN communication line open (CAN-H, CAN-L, or both)
- CAN communication line short (ground, between CAN communication lines, other harnesses)
- Error of CAN communication control circuit of the unit connected to CAN communication line

WHEN DTC OF CAN COMMUNICATION IS INDICATED EVEN THOUGH CAN COMMUNICATION SYSTEM IS NORMAL

- Removal/installation of parts: Error may be detected when removing and installing CAN communication unit and related parts while turning the ignition switch ON. (A DTC except for CAN communication may be detected.)
- Fuse blown out (removed): CAN communication of the unit may cease.
- Voltage drop: Error may be detected if voltage drops due to discharged battery when turning the ignition switch ON (Depending on the control unit which carries out CAN communication).
- Error may be detected if the power supply circuit of the control unit, which carries out CAN communication, malfunctions (Depending on the control unit which carries out CAN communication).
- Error may be detected if reprogramming is not completed normally.

CAUTION:

CAN communication system is normal if DTC of CAN communication is indicated on SELF-DIAG RESULTS of CONSULT-III under the above conditions. Erase the memory of the self-diagnosis of each unit.

Symptom When Error Occurs in CAN Communication System

INFOID:0000000006234262

In CAN communication system, multiple units mutually transmit and receive signals. Each unit cannot transmit and receive signals if any error occurs on CAN communication line. Under this condition, multiple control units related to the root cause malfunction or go into fail-safe mode.

ERROR EXAMPLE

NOTE:

- Each vehicle differs in symptom of each unit under fail-safe mode and CAN communication line wiring.
- Refer to [LAN-20, "Abbreviation List"](#) for the unit abbreviation.

Example: TCM branch line open circuit

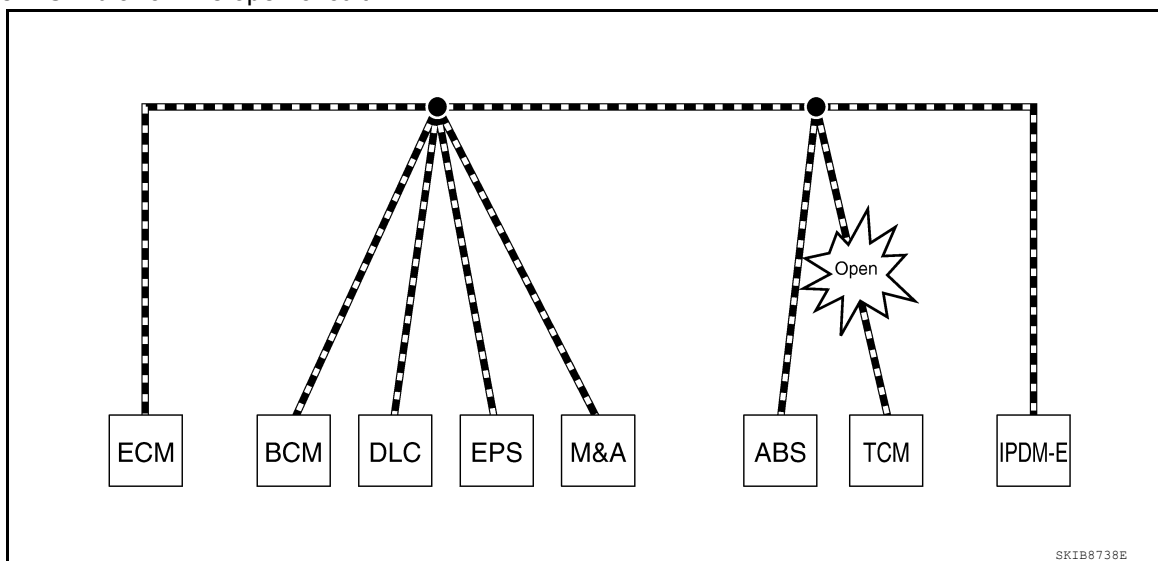

Unit name	Symptom
ECM	Engine torque limiting is affected, and shift harshness increases.
BCM	Reverse warning chime does not sound.

A
B
C
D
E
F
G
H
I
J
K
L
N
O
P

LAN

TROUBLE DIAGNOSIS

< SYSTEM DESCRIPTION >

[CAN FUNDAMENTAL]

Unit name	Symptom
EPS control unit	Normal operation.
Combination meter	<ul style="list-style-type: none"> Shift position indicator and OD OFF indicator turn OFF. Warning lamps turn ON.
ABS actuator and electric unit (control unit)	Normal operation.
TCM	No impact on operation.
IPDM E/R	Normal operation.

Example: Data link connector branch line open circuit

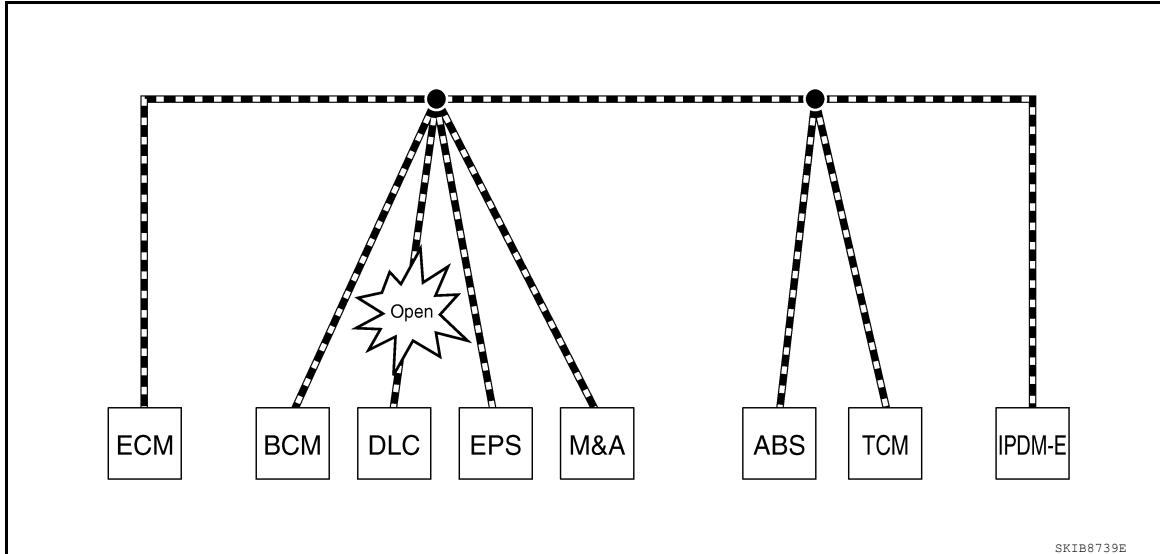

Unit name	Symptom
ECM	Normal operation.
BCM	
EPS control unit	
Combination meter	
ABS actuator and electric unit (control unit)	
TCM	
IPDM E/R	

NOTE:

- When data link connector branch line is open, transmission and reception of CAN communication signals are not affected. Therefore, no symptoms occur. However, be sure to repair malfunctioning circuit.
- The model (all units on CAN communication system are Diag on CAN) cannot perform CAN diagnosis with CONSULT-III if the following error occurs. The error is judged by the symptom.

Error	Difference of symptom
Data link connector branch line open circuit	Normal operation.
CAN-H, CAN-L harness short-circuit	Most of the units which are connected to the CAN communication system enter fail-safe mode or are deactivated.

TROUBLE DIAGNOSIS

< SYSTEM DESCRIPTION >

[CAN FUNDAMENTAL]

Example: Main Line Between Data Link Connector and ABS Actuator and Electric Unit (Control Unit) Open Circuit

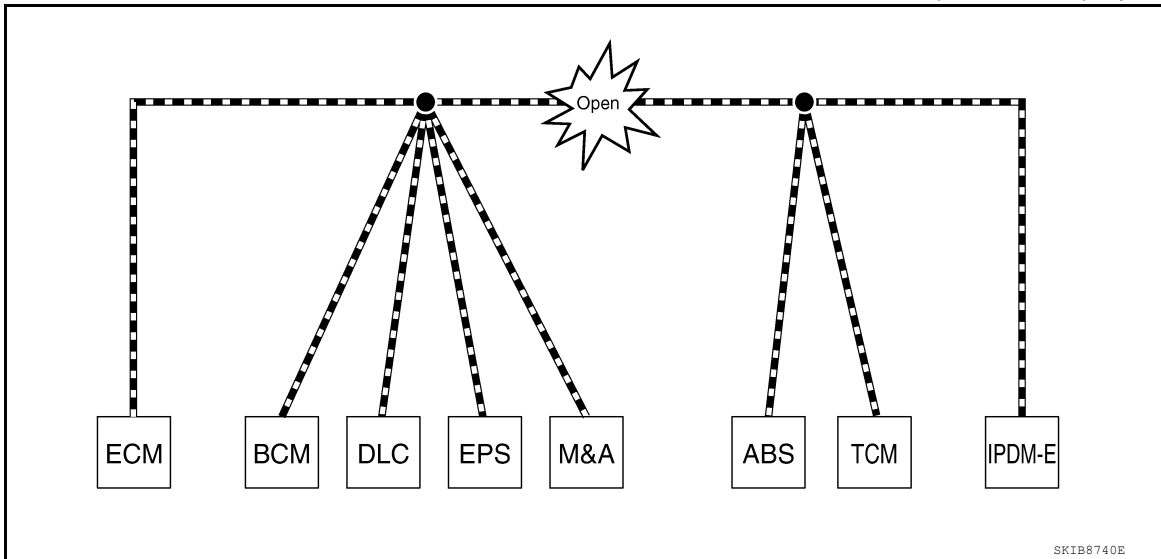

Unit name	Symptom
ECM	Engine torque limiting is affected, and shift harshness increases.
BCM	<ul style="list-style-type: none"> • Reverse warning chime does not sound. • The front wiper moves under continuous operation mode even though the front wiper switch being in the intermittent position.
EPS control unit	The steering effort increases.
Combination meter	<ul style="list-style-type: none"> • The shift position indicator and OD OFF indicator turn OFF. • The speedometer is inoperative. • The odo/trip meter stops.
ABS actuator and electric unit (control unit)	Normal operation.
TCM	No impact on operation.
IPDM E/R	When the ignition switch is ON, <ul style="list-style-type: none"> • The headlamps (Lo) turn ON. • The cooling fan continues to rotate.

Example: CAN-H, CAN-L Harness Short Circuit

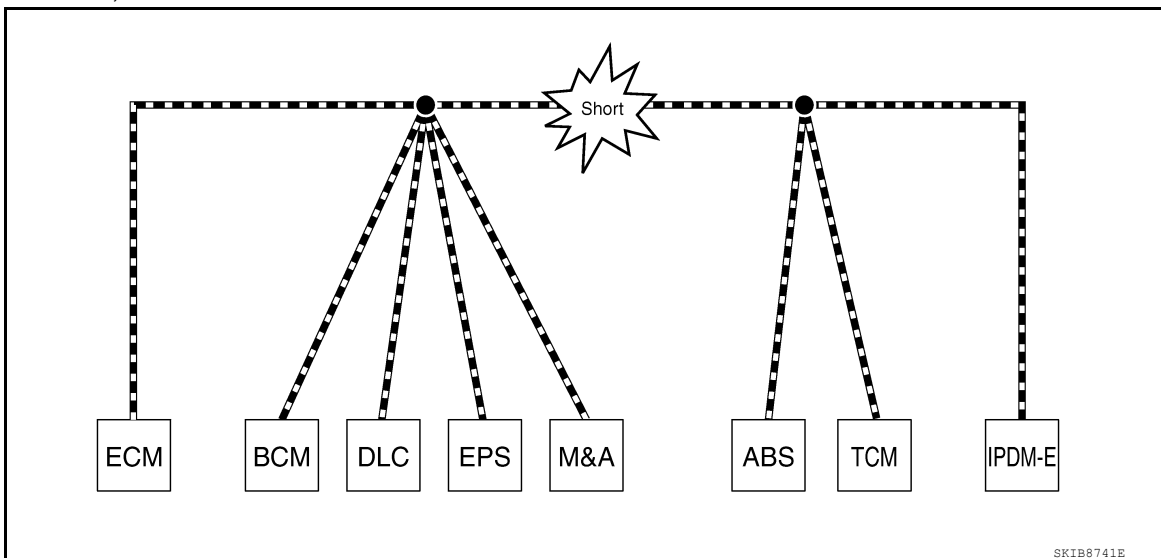

A
B
C
D
E
F
G
H
I
J
K
L
N
O
P

LAN

TROUBLE DIAGNOSIS

< SYSTEM DESCRIPTION >

[CAN FUNDAMENTAL]

Unit name	Symptom
ECM	<ul style="list-style-type: none"> Engine torque limiting is affected, and shift harshness increases. Engine speed drops.
BCM	<ul style="list-style-type: none"> Reverse warning chime does not sound. The front wiper moves under continuous operation mode even though the front wiper switch being in the intermittent position. The room lamp does not turn ON. The engine does not start (if an error or malfunction occurs while turning the ignition switch OFF.) The steering lock does not release (if an error or malfunction occurs while turning the ignition switch OFF.)
EPS control unit	The steering effort increases.
Combination meter	<ul style="list-style-type: none"> The tachometer and the speedometer do not move. Warning lamps turn ON. Indicator lamps do not turn ON.
ABS actuator and electric unit (control unit)	Normal operation.
TCM	No impact on operation.
IPDM E/R	When the ignition switch is ON, <ul style="list-style-type: none"> The headlamps (Lo) turn ON. The cooling fan continues to rotate.

CAN Diagnosis with CONSULT-III

INFOID:000000006234263

CAN diagnosis on CONSULT-III extracts the root cause by receiving the following information.

- Response to the system call
- Control unit diagnosis information
- Self-diagnosis
- CAN diagnostic support monitor

Self-Diagnosis

INFOID:000000006538825

If communication signals cannot be transmitted or received among units communicating via CAN communication line, CAN communication-related DTC is displayed on the CONSULT-III "Self Diagnostic Result" screen.

NOTE:

The following table shows examples of CAN communication-related DTC. For other DTC, refer to the applicable sections.

DTC	Self-diagnosis item (CONSULT-III indication)	DTC detection condition		Inspection/Action
U1000	CAN COMM CIRCUIT	ECM	When ECM is not transmitting or receiving CAN communication signal of OBD (emission-related diagnosis) for 2 seconds or more.	Start the inspection. Refer to the applicable section of the indicated control unit.
		Except for ECM	When a control unit (except for ECM) is not transmitting or receiving CAN communication signal for 2 seconds or more.	
U1001	CAN COMM CIRCUIT	When ECM is not transmitting or receiving CAN communication signal other than OBD (emission-related diagnosis) for 2 seconds or more.		
U1002	SYSTEM COMM	When a control unit is not transmitting or receiving CAN communication signal for 2 seconds or less.		
U1010	CONTROL UNIT(CAN)	When an error is detected during the initial diagnosis for CAN controller of each control unit.		

CAN Diagnostic Support Monitor

INFOID:000000006234265

MONITOR ITEM (CONSULT-III)

TROUBLE DIAGNOSIS

< SYSTEM DESCRIPTION >

[CAN FUNDAMENTAL]

Example: CAN DIAG SUPPORT MNTR indication

Without PAST			With PAST		
ECM			ECM		
	PRSNT	PAST		PRSNT	PAST
INITIAL DIAG	OK		TRANSMIT DIAG	OK	OK
TRANSMIT DIAG	OK		VDC/TCS/ABS	-	-
TCM	OK		METER/M&A	OK	OK
VDC/TCS/ABS	UNKWN		BCM/SEC	OK	OK
METER/M&A	OK		ICC	-	-
ICC	UNKWN		HVAC	-	-
BCM/SEC	OK		TCM	OK	OK
IPDM E/R	OK		EPS	-	-
			IPDM E/R	OK	OK
			e4WD	-	-
			AWD/4WD	OK	OK

JSMIA0015GB

Without PAST

Item	PRSNT	Description
Initial diagnosis	OK	Normal at present
	NG	Control unit error (Except for some control units)
Transmission diagnosis	OK	Normal at present
	UNKWN	Unable to transmit signals for 2 seconds or more. Diagnosis not performed
Control unit name (Reception diagnosis)	OK	Normal at present
	UNKWN	Unable to receive signals for 2 seconds or more. Diagnosis not performed
	UNKWN	No control unit for receiving signals. (No applicable optional parts)

With PAST

Item	PRSNT	PAST	Description
Transmission diagnosis	OK	OK	Normal at present and in the past
		1 – 39	Normal at present, but unable to transmit signals for 2 seconds or more in the past. (The number indicates the number of ignition switch cycles from OFF to ON.)
	UNKWN	0	Unable to transmit signals for 2 seconds or more at present.
Control unit name (Reception diagnosis)	OK	OK	Normal at present and in the past
		1 – 39	Normal at present, but unable to receive signals for 2 seconds or more in the past. (The number indicates the number of ignition switch cycles from OFF to ON.)
	UNKWN	0	Unable to receive signals for 2 seconds or more at present.
	-	-	Diagnosis not performed. No control unit for receiving signals. (No applicable optional parts)

MONITOR ITEM (ON-BOARD DIAGNOSIS)

NOTE:

For some models, CAN communication diagnosis result is received from the vehicle monitor.

TROUBLE DIAGNOSIS

[CAN FUNDAMENTAL]

< SYSTEM DESCRIPTION >

Example: Vehicle Display

Item	Result indicated	Error counter	Description
CAN_COMM (Initial diagnosis)	OK	0	Normal at present
	NG	1 – 50	Control unit error (The number indicates how many times diagnosis has been run.)
CAN_CIRC_1 (Transmission diagnosis)	OK	0	Normal at present
	UNKWN	1 – 50	Unable to transmit for 2 seconds or more at present. (The number indicates how many times diagnosis has been run.)
CAN_CIRC_2 – 9 (Reception diagnosis of each unit)	OK	0	Normal at present
	UNKWN	1 – 50	Unable to transmit for 2 seconds or more at present. (The number indicates how many times diagnosis has been run.)
	UNKWN	1 – 50	Diagnosis not performed. No control unit for receiving signals. (No applicable optional parts)

How to Use CAN Communication Signal Chart

INFOID:000000006234266

The CAN communication signal chart lists the signals needed for trouble diagnosis. It is useful for detecting the root cause by finding a signal related to the symptom, and by checking transmission and reception unit.

Example: Tachometer does not move even though the engine rotates.

T: Transmit R: Receive

Signal name/Connecting unit	ECM	BCM	M&A	STRG	ABS	IPDM-E
A/C compressor feedback signal	T		R			
A/C compressor request signal	T					R
Accelerator pedal position signal	T				R	
Cooling fan motor operation signal	T					R
Engine coolant temperature signal	T		R			
Engine speed signal	T		R		R	
Fuel consumption monitor signal	T		R			
Malfunction indicator lamp signal	T		R			
A/C switch signal	R	T				
Ignition switch signal		T				R
Sleep/wake up signal		T	R			R

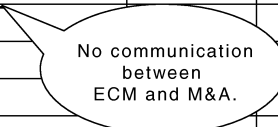

It indicates that an error occurs between ECM and M&A (Shaded area).

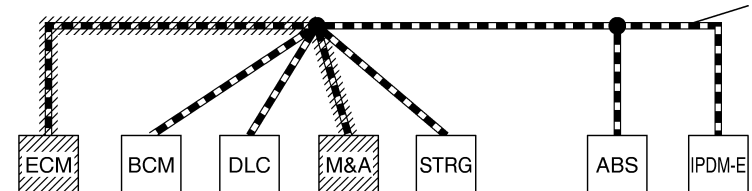

SKIB8715E

BASIC INSPECTION

DIAGNOSIS AND REPAIR WORKFLOW

Trouble Diagnosis Flow Chart

INFOID:000000006234267

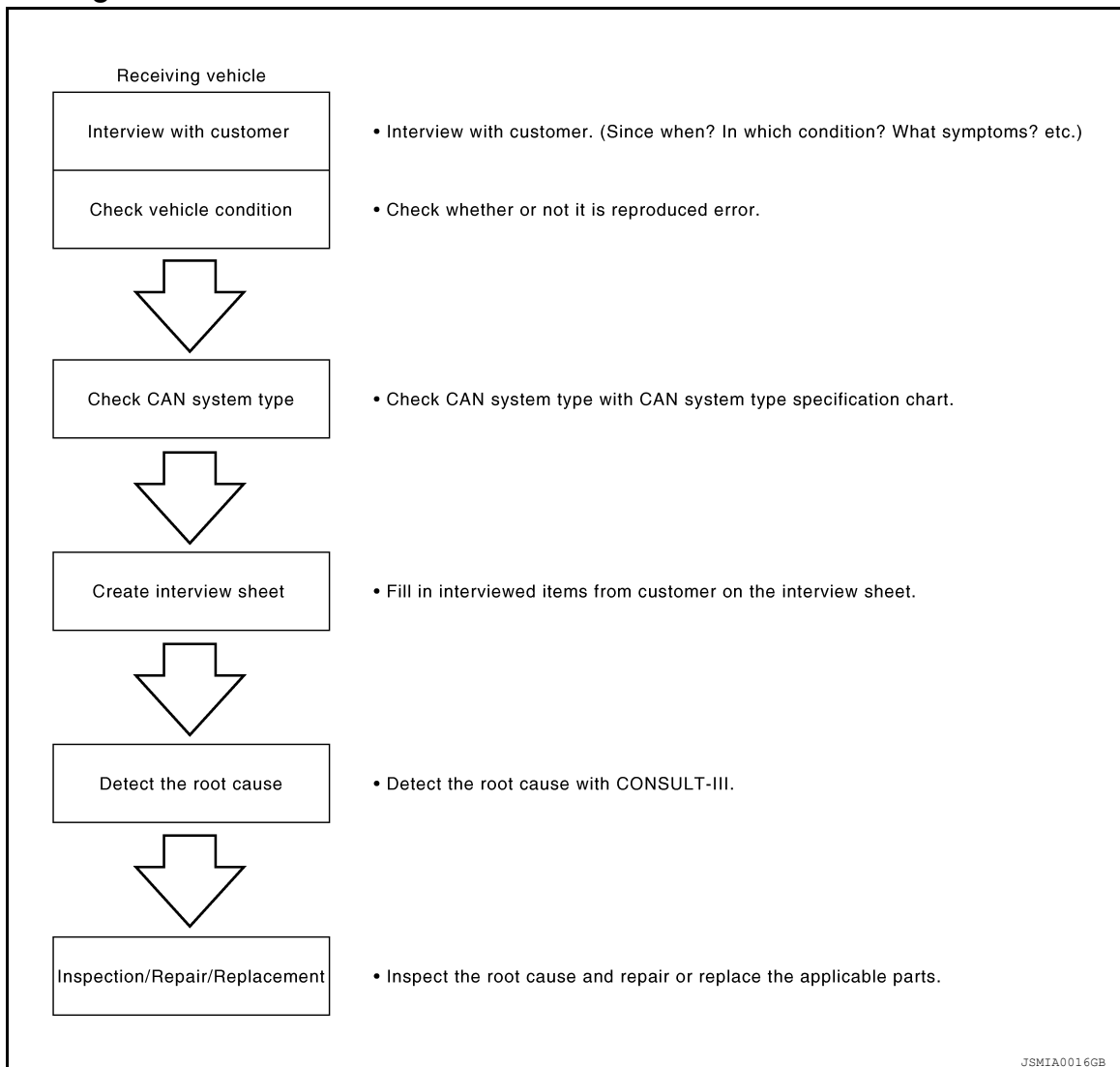

Trouble Diagnosis Procedure

INFOID:000000006234268

INTERVIEW WITH CUSTOMER

Interview with the customer is important to detect the root cause of CAN communication system errors and to understand vehicle condition and symptoms for proper trouble diagnosis.

Points in interview

- What: Parts name, system name
- When: Date, Frequency
- Where: Road condition, Place
- In what condition: Driving condition/environment
- Result: Symptom

NOTE:

- Check normal units as well as error symptoms.
- Example: Circuit between ECM and the combination meter is judged normal if the customer indicates tachometer functions normally.
- When a CAN communication system error is present, multiple control units may malfunction or go into fail-safe mode.

A
B
C
D
E
F
G
H
I
J
K
L

LAN

N
O
P

DIAGNOSIS AND REPAIR WORKFLOW

< BASIC INSPECTION >

[CAN FUNDAMENTAL]

- Indication of the combination meter is important to detect the root cause because it is the most obvious to the customer, and it performs CAN communication with many units.

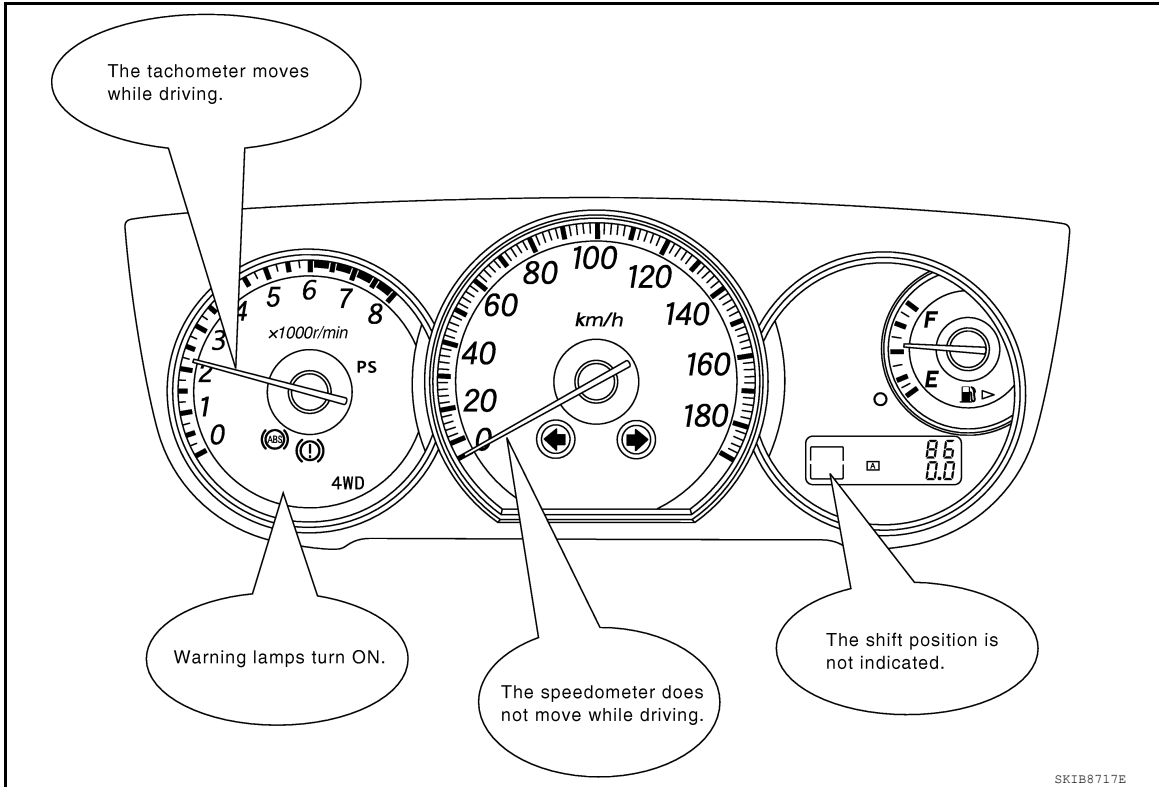

INSPECTION OF VEHICLE CONDITION

Check whether the symptom is reproduced or not.

NOTE:

Do not turn the ignition switch OFF or disconnect the battery cable while reproducing the error. The error may temporarily correct itself, making it difficult to determine the root cause.

CHECK OF CAN SYSTEM TYPE (HOW TO USE CAN SYSTEM TYPE SPECIFICATION CHART)

Determine CAN system type based on vehicle equipment.

NOTE:

- This chart is used if CONSULT-III does not automatically recognize CAN system type.
- There are two styles for CAN system type specification charts. Depending on the number of available system types, either style A or style B may be used.

CAN System Type Specification Chart (Style A)

NOTE:

DIAGNOSIS AND REPAIR WORKFLOW

< BASIC INSPECTION >

[CAN FUNDAMENTAL]

CAN system type is easily checked with the vehicle equipment identification information shown in the chart.

Example:
Vehicle is equipped as follows: Wagon, AWD, VQ35DE, CVT, VDC, and Intelligent Key system. (○ shows an example of CAN system type.)

CAN System Specification Chart
Determine CAN system type from the following specification chart.

Body type	Wagon					
Axle	2WD			AWD		
Engine	QR25DE		VQ35DE			
Transmission	A/T			CVT		
Brake control	ABS			VDC		
Intelligent Key system		X		X		X
CAN system type	1	2	3	4	5	6
CAN communication signal chart	XX-XX. "TYPE 1/TYPE 2"		XX-XX. "TYPE 3/TYPE 4"		XX-XX. "TYPE 5/TYPE 6"	

X : Applicable

VEHICLE EQUIPMENT IDENTIFICATION INFORMATION
NOTE:
Check CAN system type from the vehicle shape and equipment.

With VDC

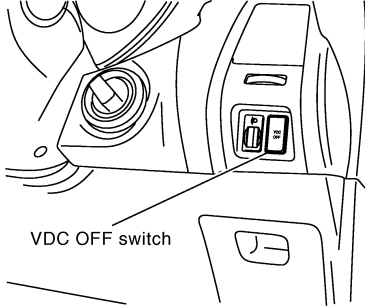

VDC OFF switch

With Intelligent Key system

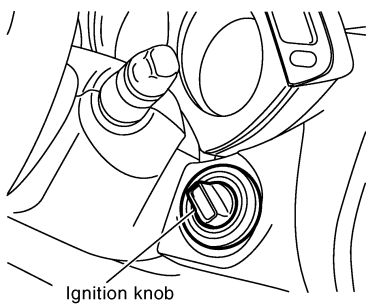

Ignition knob

[For the above case, CAN system type is "6".]

JSMIA0017GB

A
B
C
D
E
F
G
H
I
J
K
L

CAN System Type Specification Chart (Style B)

NOTE:

LAN

N
O
P

DIAGNOSIS AND REPAIR WORKFLOW

< BASIC INSPECTION >

[CAN FUNDAMENTAL]

CAN system type is easily checked with the vehicle equipment identification information shown in the chart.

Example:
Vehicle is equipped as follows: Sedan, 2WD, MR20DE, CVT, ABS, Active AFS, Intelligent Key system, Navigation system and Automatic drive positioner. (○ shows an example of CAN system type.)

CAN System Specification Chart
Refer to the specification as shown in the chart.

Body type	Sedan		
Axle	2WD		AWD
Engine	HR15DE	MR20DE	HR15DE
Transmission	AT	CVT	AT
Brake control	ABS		
Specification chart	XXX SPECIFICATION CHART A	YYY SPECIFICATION CHART B	XXX SPECIFICATION CHART C

x: Applicable

Check the vehicle equipment with the vehicle identification number plate.
Check the vehicle equipment.
Select the applicable vehicle equipment. Refer to the specification chart.

SPECIFICATION CHART B
Determine CAN system type from the following specification chart.

Body type	Sedan											
Axle	2WD											
Engine	MR20DE											
Transmission	CVT											
Brake control	ABS											
Active AFS	x			x	x			x	x		x	
Intelligent Key system		x		x		x	x	x	x	x	x	
Navigation system			x			x	x		x		x	
Automatic drive positioner									x	x	x	
CAN system type	9	10	11	12	13	14	15	16	17	18	19	20
CAN communication signal chart	XXX SPECIFICATION CHART A YYY SPECIFICATION CHART B ZZZ SPECIFICATION CHART C											

x: Applicable

Check the vehicle equipment.
The number indicates the CAN system type of the vehicle.

VEHICLE EQUIPMENT IDENTIFICATION INFORMATION
NOTE:
Check CAN system type from the vehicle shape and equipment.

<p>With active AFS</p> <p>Bending lamp Xenon bulb</p>	<p>With Intelligent Key system</p> <p>Ignition knob</p>
<p>With navigation system</p> <p>Display Multifunction switch</p>	<p>With automatic drive positioner</p> <p>Seat memory switch</p>

In the above example,
 • Checking Xenon bulb and bending lamp lead to judge whether or not Active AFS is equipped.
 • Checking the ignition knob leads to judge whether or not Intelligent Key system is equipped.
 • Checking display and multifunction switch lead to judge whether or not Navigation system is equipped.
 • Checking seat memory switch leads to judge whether or not Automatic drive positioner is equipped.

[For the above case, CAN system type is "20".]

JSMIA0018GB

CREATE INTERVIEW SHEET

Fill out the symptom described by the customer, vehicle condition, and CAN system type on the interview sheet.

DIAGNOSIS AND REPAIR WORKFLOW

< BASIC INSPECTION >

[CAN FUNDAMENTAL]

Interview Sheet (Example)

CAN Communication System Diagnosis Interview Sheet	
Date received:	3, Feb. 2006
Type: DBA-KG11	VIN No.: KG11-005040
Model: BDRARGZ397EDA-E-J-	
First registration: 10, Jan. 2001	Mileage: 62,140
CAN system type: Type 19	
Symptom (Results from interview with customer)	
<ul style="list-style-type: none">•Headlamps suddenly turn ON while driving the vehicle.•The engine does not restart after stopping the vehicle and turning the ignition switch OFF.•The cooling fan continues rotating while turning the ignition switch ON.	
Condition at inspection	
Error Symptom: Present / Past	
<p>The engine does not start. While turning the ignition switch ON,</p> <ul style="list-style-type: none">•The headlamps (Lo) turn ON, and the cooling fan continues rotating.•The interior lamp does not turn ON.	

JSMIA0019GB

A
B
C
D
E
F
G
H
I
J
K
L

LAN

DETECT THE ROOT CAUSE

CAN diagnosis function of CONSULT-III detects the root cause.

N
O
P

HOW TO USE THIS SECTION

< HOW TO USE THIS MANUAL >

[CAN]

HOW TO USE THIS MANUAL

HOW TO USE THIS SECTION

Caution

INFOID:000000006234269

- This section describes information peculiar to a vehicle and inspection procedures.
- For trouble diagnosis procedure, refer to [LAN-15, "Trouble Diagnosis Procedure"](#).

Abbreviation List

INFOID:000000006234270

Unit name abbreviations in CONSULT-III CAN diagnosis and in this section are as per the following list.

Abbreviation	Unit name
A-BAG	Air bag diagnosis sensor unit
ABS	ABS actuator and electric unit (control unit)
ADP	Driver seat control unit
AV	AV control unit
BCM	BCM
DLC	Data link connector
ECM	ECM
HVAC	A/C auto amp.
IPDM-E	IPDM E/R
M&A	Combination meter
STRG	Steering angle sensor
TCM	TCM

PRECAUTION

PRECAUTIONS

Precaution for Supplemental Restraint System (SRS) "AIR BAG" and "SEAT BELT PRE-TENSIONER"

INFOID:000000006234271

The Supplemental Restraint System such as "AIR BAG" and "SEAT BELT PRE-TENSIONER", used along with a front seat belt, helps to reduce the risk or severity of injury to the driver and front passenger for certain types of collision. This system includes seat belt switch inputs and dual stage front air bag modules. The SRS system uses the seat belt switches to determine the front air bag deployment, and may only deploy one front air bag, depending on the severity of a collision and whether the front occupants are belted or unbelted. Information necessary to service the system safely is included in the "SRS AIR BAG" and "SEAT BELT" of this Service Manual.

WARNING:

Always observe the following items for preventing accidental activation.

- To avoid rendering the SRS inoperative, which could increase the risk of personal injury or death in the event of a collision that would result in air bag inflation, all maintenance must be performed by an authorized NISSAN/INFINITI dealer.
- Improper maintenance, including incorrect removal and installation of the SRS, can lead to personal injury caused by unintentional activation of the system. For removal of Spiral Cable and Air Bag Module, see "SRS AIR BAG".
- Never use electrical test equipment on any circuit related to the SRS unless instructed to in this Service Manual. SRS wiring harnesses can be identified by yellow and/or orange harnesses or harness connectors.

PRECAUTIONS WHEN USING POWER TOOLS (AIR OR ELECTRIC) AND HAMMERS

WARNING:

Always observe the following items for preventing accidental activation.

- When working near the Air Bag Diagnosis Sensor Unit or other Air Bag System sensors with the ignition ON or engine running, never use air or electric power tools or strike near the sensor(s) with a hammer. Heavy vibration could activate the sensor(s) and deploy the air bag(s), possibly causing serious injury.
- When using air or electric power tools or hammers, always switch the ignition OFF, disconnect the battery, and wait at least 3 minutes before performing any service.

Precautions Necessary for Steering Wheel Rotation after Battery Disconnect (Early Production, With Electronic Steering Column Lock)

INFOID:000000006234272

NOTE:

- Before removing and installing any control units, first turn the push-button ignition switch to the LOCK position, then disconnect both battery cables.
- After finishing work, confirm that all control unit connectors are connected properly, then re-connect both battery cables.
- Always use CONSULT-III to perform self-diagnosis as a part of each function inspection after finishing work. If a DTC is detected, perform trouble diagnosis according to self-diagnosis results.

This vehicle is equipped with a push-button ignition switch and a steering lock unit.

If the battery is disconnected or discharged, the steering wheel will lock and cannot be turned.

If turning the steering wheel is required with the battery disconnected or discharged, follow the procedure below before starting the repair operation.

OPERATION PROCEDURE

1. Connect both battery cables.

NOTE:

Supply power using jumper cables if battery is discharged.

2. Carry the Intelligent Key or insert it to the key slot and turn the push-button ignition switch to ACC position. (At this time, the steering lock will be released.)
3. Disconnect both battery cables. The steering lock will remain released with both battery cables disconnected and the steering wheel can be turned.
4. Perform the necessary repair operation.

A
B
C
D
E
F
G
H
I
J
K
L

LAN

N
O
P

PRECAUTIONS

[CAN]

< PRECAUTION >

- When the repair work is completed, re-connect both battery cables. With the brake pedal released, turn the push-button ignition switch from ACC position to ON position, then to LOCK position. (The steering wheel will lock when the push-button ignition switch is turned to LOCK position.)
- Perform self-diagnosis check of all control units using CONSULT-III.

Precautions for Trouble Diagnosis

INFOID:000000006234273

CAUTION:

- Never apply 7.0 V or more to the measurement terminal.
- Use a tester with open terminal voltage of 7.0 V or less.
- Turn the ignition switch OFF and disconnect the battery cable from the negative terminal when checking the harness.

Precautions for Harness Repair

INFOID:000000006234274

- Solder the repaired area and wrap tape around the soldered area.

NOTE:

A fray of twisted lines must be within 110 mm (4.33 in).

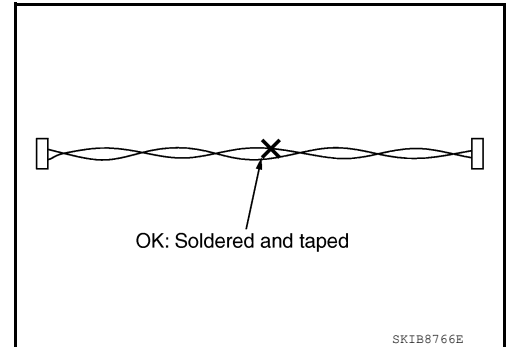

- Bypass connection is never allowed at the repaired area.

NOTE:

Bypass connection may cause CAN communication error. The spliced wire becomes separated and the characteristics of twisted line are lost.

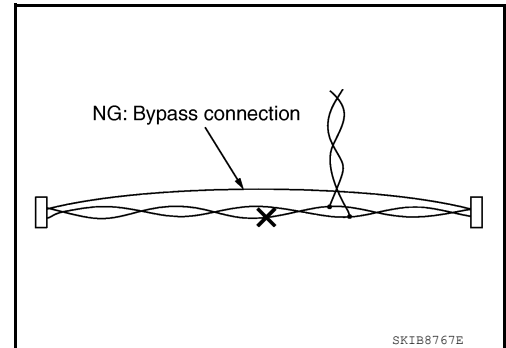

- Replace the applicable harness as an assembly if error is detected on the shield lines of CAN communication line.

DIAGNOSIS AND REPAIR WORKFLOW

< BASIC INSPECTION >

[CAN]

BASIC INSPECTION

DIAGNOSIS AND REPAIR WORKFLOW

Interview Sheet

INFOID:000000006234275

CAN Communication System Diagnosis Interview Sheet

Date received:

Type:

VIN No.:

Model:

First registration:

Mileage:

CAN system type:

Symptom (Results from interview with customer)

Condition at inspection

Error symptom : Present / Past

SKIB8898E

A
B
C
D
E
F
G
H
I
J
K
L
N
O
P

LAN

CAN COMMUNICATION SYSTEM

[CAN]

< SYSTEM DESCRIPTION >

SYSTEM DESCRIPTION

CAN COMMUNICATION SYSTEM

CAN System Specification Chart

INFOID:000000006234276

Determine CAN system type from the following specification chart.

NOTE:

Refer to [LAN-15. "Trouble Diagnosis Procedure"](#) for how to use CAN system specification chart.

Body type	Sedan					
Axle	2WD					
Engine	VQ35DE					
Transmission	CVT					
Brake control	VDC					
Destination	Except for Mexico				For Mexico	
Automatic drive positioner		×		×		×
Color display			×	×		
CAN system type	1	2	3	4	5	6

×: Applicable

VEHICLE EQUIPMENT IDENTIFICATION INFORMATION

NOTE:

Check CAN system type from the vehicle shape and equipment.

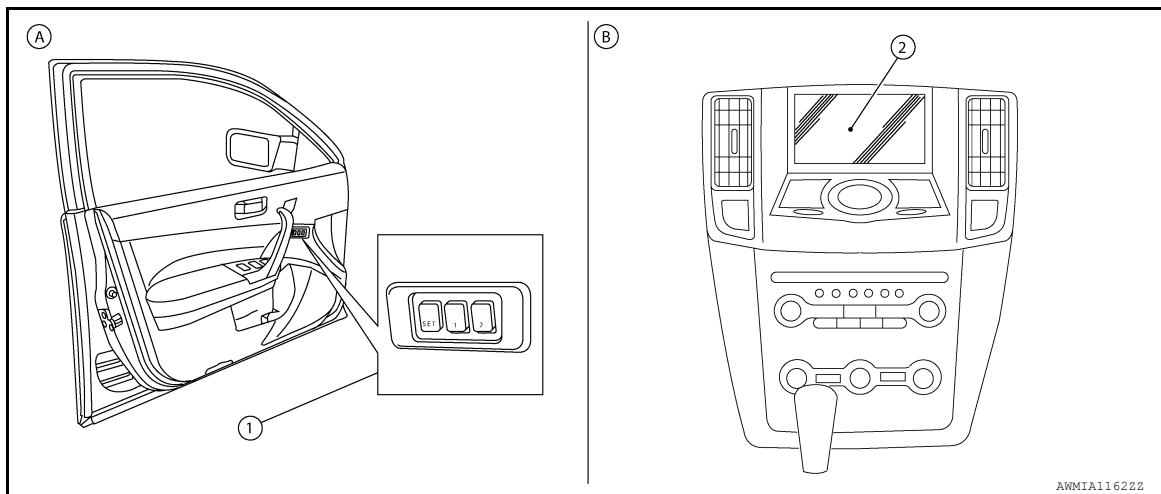

- 1. Seat memory switches
- 2. Color display
- A. With automatic drive positioner
- B. With color display

CAN Communication Signal Chart

INFOID:000000006234277

Refer to [LAN-14. "How to Use CAN Communication Signal Chart"](#) for how to use CAN communication signal chart.

NOTE:

Refer to [LAN-20. "Abbreviation List"](#) for the abbreviations of the connecting units.

T: Transmit R: Receive

Signal name/Connecting unit	ECM	ADP	BCM	M&A	AV	HVAC	STRG	ABS	TCM	IPDM-E
A/C compressor request signal	T									R
Accelerator pedal position signal	T							R	R	

CAN COMMUNICATION SYSTEM

< SYSTEM DESCRIPTION >

[CAN]

Signal name/Connecting unit	ECM	ADP	BCM	M&A	AV	HVAC	STRG	ABS	TCM	IPDM-E
ASCD CRUISE indicator signal	T			R						
ASCD SET indicator signal	T			R						
Closed throttle position signal	T								R	
Cooling fan speed request signal	T									R
Engine and CVT integrated control signal	T								R	
	R								T	
Engine coolant temperature signal	T		R	R	R	R		R	R	
Engine speed signal	T			R	R	R		R	R	
Engine status signal	T		R							
Fuel consumption monitor signal	T			R						
				T	R					
Malfunction indicator lamp signal	T			R						
Power generation command value signal	T									R
System setting signal		T	T		R					
		R	R		T					
A/C switch signal	R		T			T				
Blower fan motor switch signal	R		T			T				
Steering angle sensor signal					R ^{*1}		T	R		
Buzzer output signal			T	R						
Cornering lamp request signal			T							R
Day time running light request signal			T			R				R
Door lock/unlock status signal		R	T							
Door switch signal		R	T	R	R					R
Front fog light request signal			T	R		R				R
Front wiper request signal			T			R		R		R
High beam request signal			T	R		R		R		R
Horn chirp signal			T							R
Ignition switch signal		R	T							R
			R							T
Key fob door unlock signal		R	T							
Key fob ID signal		R	T							
Key switch signal		R	T							
Key warning signal			T	R						
Low beam request signal			T			R				R
Oil pressure switch signal			T	R						
			R	R						T
Position light request signal			T	R		R		R		R
Rear window defogger control signal			T			R				R
	R				R	R				T
Rear window defogger switch signal			T			R				R
Sleep wake up signal		R	T	R						R
Stop lamp switch signal			T						R	
Theft warning horn request signal			T							R

A
B
C
D
E
F
G
H
I
J
K
L
N
O
P

LAN

CAN COMMUNICATION SYSTEM

< SYSTEM DESCRIPTION >

[CAN]

Signal name/Connecting unit	ECM	ADP	BCM	M&A	AV	HVAC	STRG	ABS	TCM	IPDM-E
Trunk switch signal			T	R	R					
Turn indicator signal			T	R		R		R		
Distance to empty signal				T	R					
Fuel level low warning signal				T	R					
Fuel level sensor signal	R			T						
Manual mode shift down signal				T					R	
Manual mode shift up signal				T					R	
Manual mode signal				T					R	
Market information signal				T	R					
Not manual mode signal				T					R	
Paddle shifter shift down signal*2				T					R	
Paddle shifter shift up signal*2				T					R	
Parking brake switch signal			R	T	R			R		
Seat belt buckle switch signal			R	T						
Sleep-ready signal			R	T						T
Vehicle speed signal	R	R	R	T	R					R
			R	R				T	R	
A/C control signal					T	R				
					R	T				
ABS operation signal								T	R	
ABS warning lamp signal				R				T		
Brake warning lamp signal				R				T		
SLIP indicator lamp signal				R				T		
VDC OFF indicator lamp signal				R				T		
VDC operation signal								T	R	
CVT indicator lamp signal				R					T	
CVT self-diagnosis signal	R								T	
Input shaft revolution signal	R							R	T	
Manual mode indicator signal				R				R	T	
Output shaft revolution signal	R							R	T	
P range signal		R	R	R	R			R	T	
R range signal		R	R	R	R			R	T	
Shift position signal				R					T	
A/C compressor feedback signal						R				T
Cooling fan speed signal	R									T
Detention switch signal		R	R							T
Front wiper stop position signal			R							T
High beam status signal	R				R					T
Hood switch signal			R		R					T
Low beam status signal	R				R					T

CAN COMMUNICATION SYSTEM

< SYSTEM DESCRIPTION >

[CAN]

Signal name/Connecting unit	ECM	ADP	BCM	M&A	AV	HVAC	STRG	ABS	TCM	IPDM-E
Push-button ignition switch status signal			R							T
Steering lock unit status signal			R							T

*1: Models with rear view monitor

*2: Models with paddle shifter

NOTE:

CAN data of the air bag diagnosis sensor unit is not used by usual service work, thus it is omitted.

A
B
C
D
E
F
G
H
I
J
K
L

LAN

N
O
P

< WIRING DIAGRAM >

WIRING DIAGRAM

CAN SYSTEM

Wiring Diagram

INFOID:000000006539457

CAN SYSTEM

◊AD◊ : WITH AUTOMATIC DRIVE POSITIONER
 ◊XA◊ : WITHOUT AUTOMATIC DRIVE POSITIONER

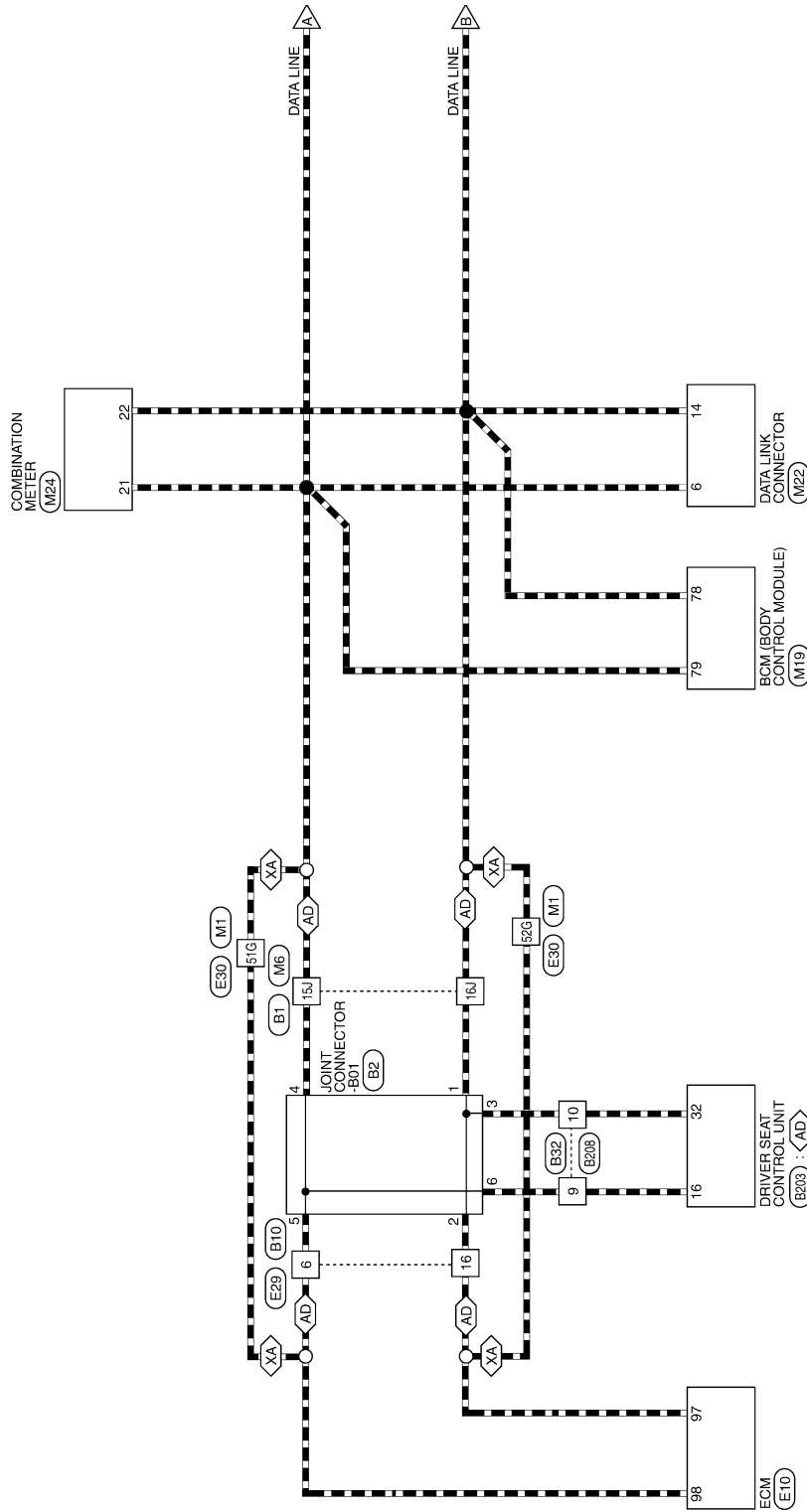

ABMWA0486GB

CAN SYSTEM

< WIRING DIAGRAM >

[CAN]

- ◊CD◊ : WITH COLOR DISPLAY
- ◊EN◊ : WITHOUT NAVI
- ◊NV◊ : WITH NAVI
- ◊NX◊ : EXCEPT MEX/CO
- 1:◊EN◊ : 86 *2
- 2:◊NV◊ : 46

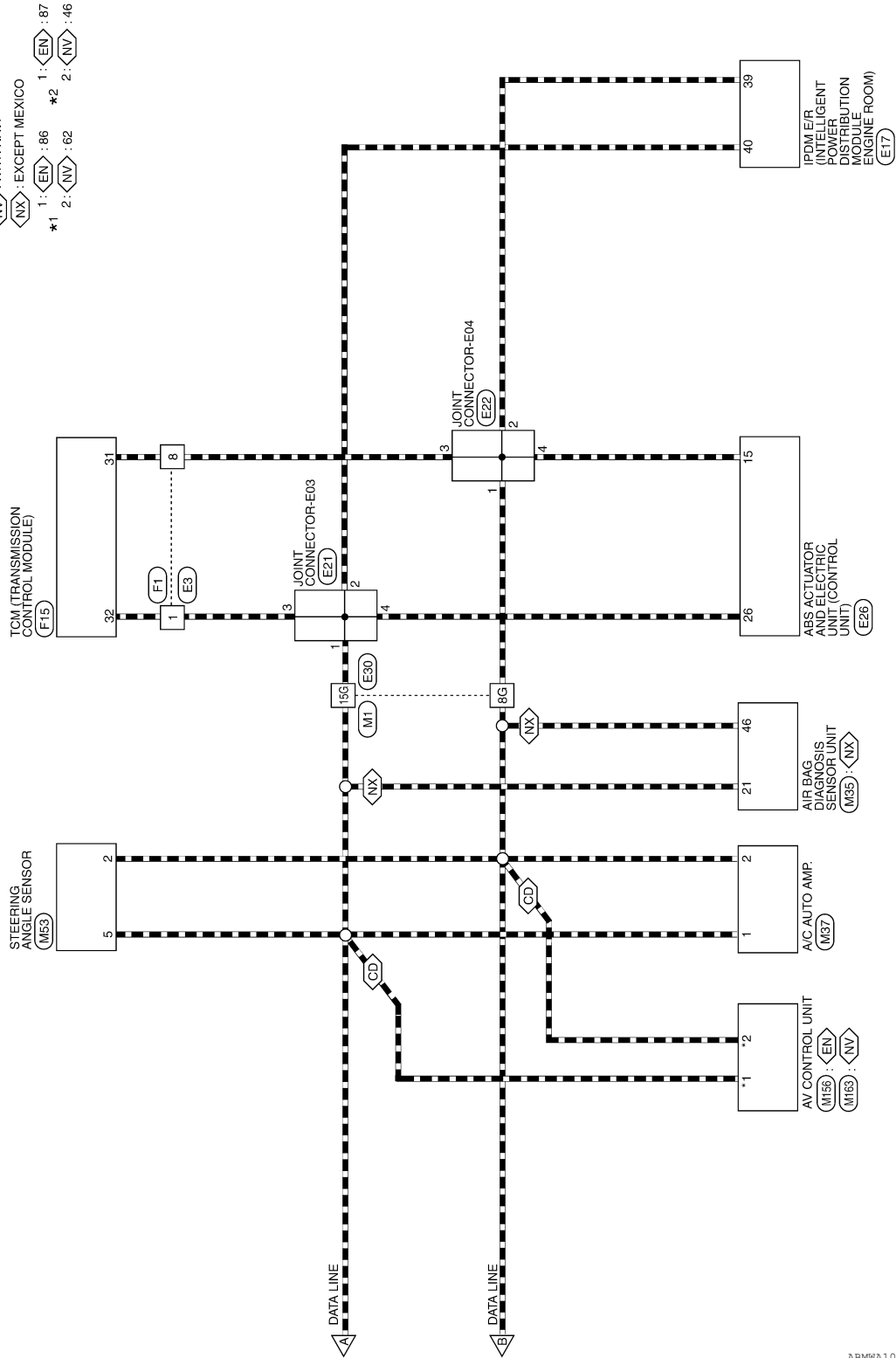

A
B
C
D
E
F
G
H
I
J
K
L
N
O
P

LAN

ABMWA1027GB

CAN SYSTEM CONNECTORS

Connector No.	M1
Connector Name	WIRE TO WIRE
Connector Color	WHITE

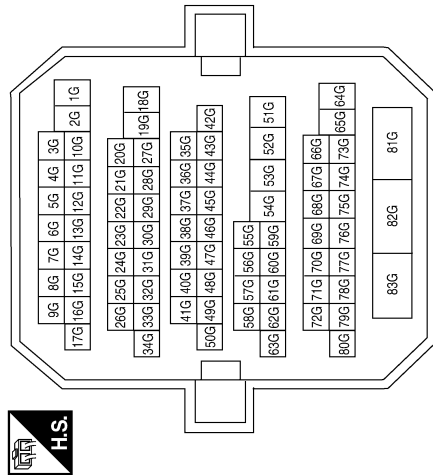

Terminal No.	Color of Wire	Signal Name
8G	P	-
15G	L	-
51G	L	-
52G	P	-

Connector No.	M6
Connector Name	WIRE TO WIRE
Connector Color	WHITE

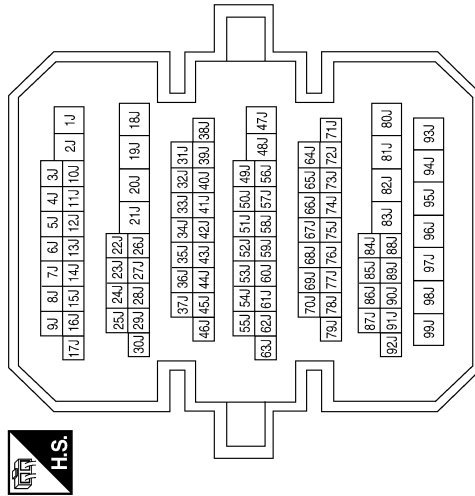

Terminal No.	Color of Wire	Signal Name
15J	L	-
16J	P	-

Connector No.	M19
Connector Name	BCM (BODY CONTROL MODULE)
Connector Color	BLACK

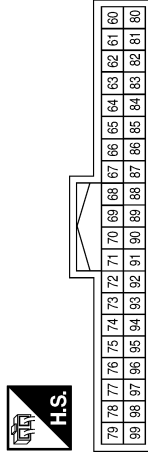

Terminal No.	Color of Wire	Signal Name
78	P	CAN-L
79	L	CAN-H

CAN SYSTEM

< WIRING DIAGRAM >

[CAN]

Connector No.	M35
Connector Name	AIR BAG DIAGNOSIS SENSOR UNIT
Connector Color	YELLOW



21	24	49	1
22	11	46	48
16	12	15	18
3	4	6	5

Terminal No.	Color of Wire	Signal Name
21	L	CAN-H
46	P	CAN-L

Connector No.	M24
Connector Name	COMBINATION METER
Connector Color	WHITE



1	2	3	4	5	6	7	8	9	10	11	12	13	14	15	16	17	18	19	20
21	22	23	24	25	26	27	28	29	30	31	32	33	34	35	36	37	38	39	40

Terminal No.	Color of Wire	Signal Name
21	L	CAN-H
22	P	CAN-L

Connector No.	M22
Connector Name	DATA LINK CONNECTOR
Connector Color	WHITE



9	10	11	12	13	14	15	16
1	2	3	4	5	6	7	8

Terminal No.	Color of Wire	Signal Name
6	L	-
14	P	-

Connector No.	M156
Connector Name	AV CONTROL UNIT (WITHOUT NAVI)
Connector Color	WHITE



91	90	89	88	87	86	85	84	83	82	81	80	79	78	77	76
107	106	105	104	103	102	101	100	99	98	97	96	95	94	93	92

Terminal No.	Color of Wire	Signal Name
86	L	CAN-H
87	P	CAN-L

Connector No.	M53
Connector Name	STEERING ANGLE SENSOR
Connector Color	WHITE



1	2	3	4
5	6	7	8

Terminal No.	Color of Wire	Signal Name
2	P	CAN-L
5	L	CAN-H

Connector No.	M37
Connector Name	A/C AUTO AMP.
Connector Color	WHITE



1	2	3	4	5	6	7	8	9	10	11	12	13	14	15	16	17	18	19	20
21	22	23	24	25	26	27	28	29	30	31	32	33	34	35	36	37	38	39	40

Terminal No.	Color of Wire	Signal Name
1	L	CAN-H
2	P	CAN-L

ABMIA2434GB

A
B
C
D
E
F
G
H
I
J
K
L
M
N
O
P

LAN

CAN SYSTEM

< WIRING DIAGRAM >

[CAN]

Connector No.	E10
Connector Name	ECM
Connector Color	BLACK

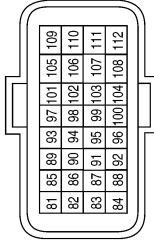

Terminal No.	Color of Wire	Signal Name
97	P	CAN-L
98	L	CAN-H

Connector No.	E3
Connector Name	WIRE TO WIRE
Connector Color	WHITE

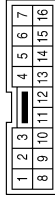

Terminal No.	Color of Wire	Signal Name
1	L	-
8	P	-

Connector No.	M163
Connector Name	AV CONTROL UNIT (WITH NAV)
Connector Color	WHITE

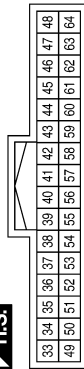

Terminal No.	Color of Wire	Signal Name
46	P	CAN-L
62	L	CAN-H

Connector No.	E22
Connector Name	JOINT CONNECTOR-E04
Connector Color	WHITE



Terminal No.	Color of Wire	Signal Name
1	P	-
2	P	-
3	P	-
4	P	-

Connector No.	E21
Connector Name	JOINT CONNECTOR-E03
Connector Color	WHITE



Terminal No.	Color of Wire	Signal Name
1	L	-
2	L	-
3	L	-
4	L	-

Connector No.	E17
Connector Name	IPDM E/R (INTELLIGENT POWER DISTRIBUTION MODULE ENGINE ROOM)
Connector Color	WHITE

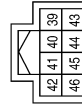

Terminal No.	Color of Wire	Signal Name
39	P	CAN-L
40	L	CAN-H

ABMIA2435GB

CAN SYSTEM

< WIRING DIAGRAM >

[CAN]

Connector No.	E29
Connector Name	WIRE TO WIRE
Connector Color	WHITE

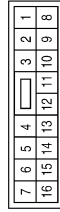

Terminal No.	Color of Wire	Signal Name
6	L	-
16	P	-

Connector No.	E26
Connector Name	ABS ACTUATOR AND ELECTRIC UNIT (CONTROL UNIT)
Connector Color	BLACK

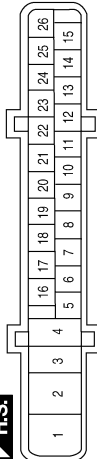

Terminal No.	Color of Wire	Signal Name
15	P	CAN-L
26	L	CAN-H

Connector No.	F1
Connector Name	WIRE TO WIRE
Connector Color	WHITE

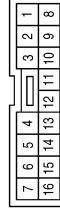

Terminal No.	Color of Wire	Signal Name
1	L	-
8	P	-

Terminal No.	Color of Wire	Signal Name
8G	P	-
15G	L	-
51G	L	-
52G	P	-

Connector No.	E30
Connector Name	WIRE TO WIRE
Connector Color	WHITE

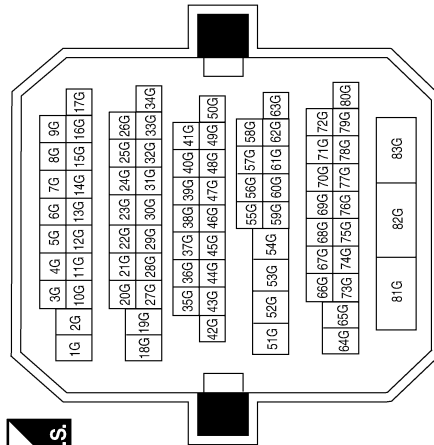

ABMIA2436GB

A
B
C
D
E
F
G
H
I
J
K
L
LAN
N
O
P

CAN SYSTEM

< WIRING DIAGRAM >

[CAN]

Terminal No.	Color of Wire	Signal Name
15J	L	-
16J	P	-

Connector No.	B1
Connector Name	WIRE TO WIRE
Connector Color	WHITE

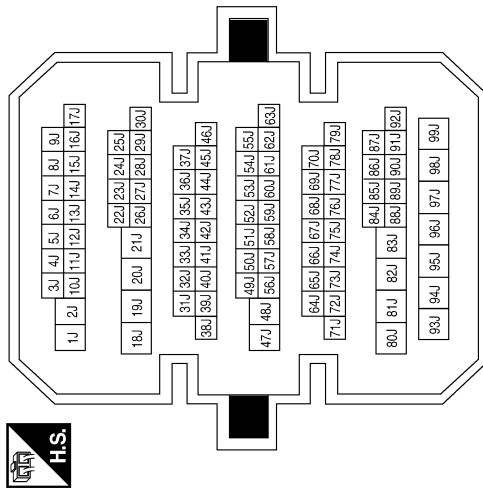

Connector No.	F15
Connector Name	TCM (TRANSMISSION CONTROL MODULE)
Connector Color	BLACK

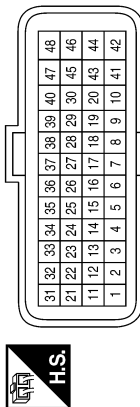

Terminal No.	Color of Wire	Signal Name
31	P	CAN-L
32	L	CAN-H

Connector No.	B32
Connector Name	WIRE TO WIRE
Connector Color	WHITE

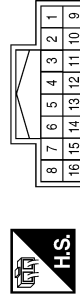

Terminal No.	Color of Wire	Signal Name
9	L	-
10	P	-

Connector No.	B10
Connector Name	WIRE TO WIRE
Connector Color	WHITE

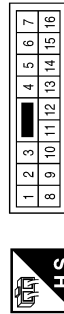

Terminal No.	Color of Wire	Signal Name
6	L	-
16	P	-

Connector No.	B2
Connector Name	JOINT CONNECTOR-B01
Connector Color	BLACK



Terminal No.	Color of Wire	Signal Name
1	P	-
2	P	-
3	P	-
4	L	-
5	L	-
6	L	-

ABMIA2437GB

CAN SYSTEM

< WIRING DIAGRAM >

[CAN]

A
B
C
D
E
F
G
H
I
J
K
L
LAN
N
O
P

Connector No.	B208
Connector Name	WIRE TO WIRE
Connector Color	WHITE



Terminal No.	Color of Wire	Signal Name
9	O/V	-
10	GR/B	-

Connector No.	B203
Connector Name	DRIVER SEAT CONTROL UNIT
Connector Color	WHITE

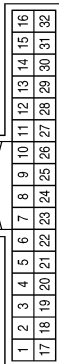

Terminal No.	Color of Wire	Signal Name
16	O/V	CAN-H
32	GR/B	CAN-L

ABMIA2438GB

DTC/CIRCUIT DIAGNOSIS

CAN COMMUNICATION SYSTEM

Component Parts Location

INFOID:000000006234278

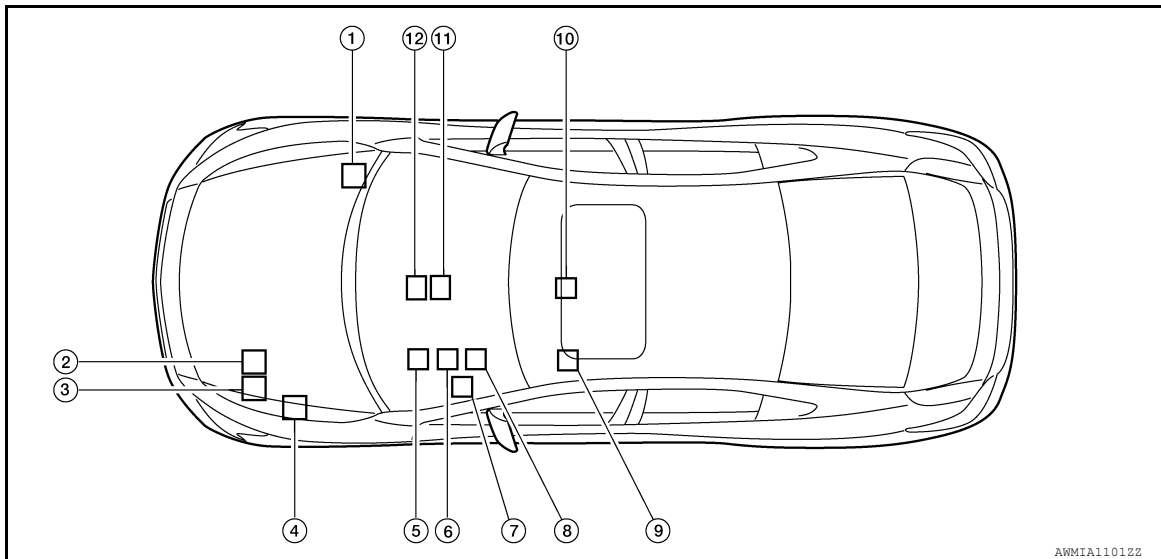

AWMIA11012Z

- | | | |
|--|------------------------------|--|
| 1. ABS actuator and electric unit (control unit) E26 | 2. TCM F15 | 3. ECM E10 |
| 4. IPDM E/R E17 | 5. BCM M19 | 6. Combination meter M24 |
| 7. Data link connector M22 | 8. Steering angle sensor M53 | 9. Driver seat control unit B203 |
| 10. Air bag diagnosis sensor unit M35 | 11. A/C auto amp. M37 | 12. AV control unit
M156: Without navigation system
M163: With navigation system |

MALFUNCTION AREA CHART

< DTC/CIRCUIT DIAGNOSIS >

[CAN]

MALFUNCTION AREA CHART

Main Line

INFOID:000000006234280

Malfunction area	Reference
Main line between driver seat control unit and data link connector	LAN-38. "Diagnosis Procedure"
Main line between data link connector and A/C auto amp.	LAN-39. "Diagnosis Procedure"
Main line between A/C auto amp. and ABS actuator and electric unit (control unit)	LAN-40. "Diagnosis Procedure"
Main line between A/C auto amp. and air bag diagnosis sensor unit	LAN-41. "Diagnosis Procedure"
Main line between air bag diagnosis sensor unit and ABS actuator and electric unit (control unit)	LAN-42. "Diagnosis Procedure"

Branch Line

INFOID:000000006234281

Malfunction area	Reference
ECM branch line circuit	LAN-43. "Diagnosis Procedure"
Driver seat control unit branch line circuit	LAN-44. "Diagnosis Procedure"
BCM branch line circuit	LAN-45. "Diagnosis Procedure"
Data link connector branch line circuit	LAN-46. "Diagnosis Procedure"
Combination meter branch line circuit	LAN-47. "Diagnosis Procedure"
AV control unit branch line circuit	LAN-48. "Diagnosis Procedure"
A/C auto amp. branch line circuit	LAN-49. "Diagnosis Procedure"
Steering angle sensor branch line circuit	LAN-50. "Diagnosis Procedure"
Air bag diagnosis sensor unit branch line circuit	LAN-51. "Diagnosis Procedure"
ABS actuator and electric unit (control unit) branch line circuit	LAN-52. "Diagnosis Procedure"
TCM branch line circuit	LAN-53. "Diagnosis Procedure"
IPDM E/R branch line circuit	LAN-54. "Diagnosis Procedure"

Short Circuit

INFOID:000000006234282

Malfunction area	Reference
CAN communication circuit	LAN-55. "Diagnosis Procedure"

A
B
C
D
E
F
G
H
I
J
K
L
N
O
P

LAN

MAIN LINE BETWEEN ADP AND DLC CIRCUIT

< DTC/CIRCUIT DIAGNOSIS >

[CAN]

MAIN LINE BETWEEN ADP AND DLC CIRCUIT

Diagnosis Procedure

INFOID:000000006234283

Regarding Wiring Diagram information, refer to [LAN-28. "Wiring Diagram"](#).

1. CHECK CONNECTOR

1. Turn the ignition switch OFF.
2. Disconnect the battery cable from the negative terminal.
3. Check the following terminals and connectors for damage, bend and loose connection (connector side and harness side).
 - Harness connector B1
 - Harness connector M6

Is the inspection result normal?

- YES >> GO TO 2.
NO >> Repair the terminal and connector.

2. CHECK HARNESS CONTINUITY (OPEN CIRCUIT)

1. Disconnect the following harness connectors.
 - Harness connectors B208 and B32
 - Harness connectors B1 and M6
2. Check the continuity between the harness connectors.

Harness connector		Harness connector		Continuity
Connector No.	Terminal No.	Connector No.	Terminal No.	
B32	9	B1	15J	Existed
	10		16J	Existed

Is the inspection result normal?

- YES >> GO TO 3.
NO >> Repair the main line between the harness connectors B32 and B1.

3. CHECK HARNESS CONTINUITY (OPEN CIRCUIT)

Check the continuity between the harness connector and the data link connector.

Harness connector		Data link connector		Continuity
Connector No.	Terminal No.	Connector No.	Terminal No.	
M6	15J	M22	6	Existed
	16J		14	Existed

Is the inspection result normal?

- YES (Present error)>>Check CAN system type decision again.
YES (Past error)>>Error was detected in the main line between the driver seat control unit and the data link connector.
NO >> Repair the main line between the harness connector M6 and the data link connector.

MAIN LINE BETWEEN DLC AND HVAC CIRCUIT

< DTC/CIRCUIT DIAGNOSIS >

[CAN]

MAIN LINE BETWEEN DLC AND HVAC CIRCUIT

Diagnosis Procedure

INFOID:00000006234284

Regarding Wiring Diagram information, refer to [LAN-28. "Wiring Diagram"](#).

1. CHECK HARNESS CONTINUITY (OPEN CIRCUIT)

1. Turn the ignition switch OFF.
2. Disconnect the battery cable from the negative terminal.
3. Disconnect the following harness connectors.
 - ECM
 - A/C auto amp.
4. Check the continuity between the data link connector and the A/C auto amp. harness connector.

Data link connector		A/C auto amp. harness connector		Continuity
Connector No.	Terminal No.	Connector No.	Terminal No.	
M22	6	M37	1	Existed
	14		2	Existed

Is the inspection result normal?

YES (Present error)>>Check CAN system type decision again.

YES (Past error)>>Error was detected in the main line between the data link connector and the A/C auto amp.

NO >> Repair the main line between the data link connector and the A/C auto amp.

LAN

MAIN LINE BETWEEN HVAC AND ABS CIRCUIT

< DTC/CIRCUIT DIAGNOSIS >

[CAN]

MAIN LINE BETWEEN HVAC AND ABS CIRCUIT

Diagnosis Procedure

INFOID:000000006234285

Regarding Wiring Diagram information, refer to [LAN-28. "Wiring Diagram"](#).

1. CHECK CONNECTOR

1. Turn the ignition switch OFF.
2. Disconnect the battery cable from the negative terminal.
3. Check the following terminals and connectors for damage, bend and loose connection (connector side and harness side).
 - Harness connector M1
 - Harness connector E30

Is the inspection result normal?

- YES >> GO TO 2.
NO >> Repair the terminal and connector.

2. CHECK HARNESS CONTINUITY (OPEN CIRCUIT)

1. Disconnect the following harness connectors.
 - A/C auto amp.
 - Harness connectors M1 and E30
2. Check the continuity between the A/C auto amp. harness connector and the harness connector.

A/C auto amp. harness connector		Harness connector		Continuity
Connector No.	Terminal No.	Connector No.	Terminal No.	
M37	1	M1	15G	Existed
	2		8G	Existed

Is the inspection result normal?

- YES >> GO TO 3.
NO >> Repair the main line between the A/C auto amp. and the harness connector M1.

3. CHECK HARNESS CONTINUITY (OPEN CIRCUIT)

1. Disconnect the connector of ABS actuator and electric unit (control unit).
2. Check the continuity between the harness connector and the ABS actuator and electric unit (control unit) harness connector.

Harness connector		ABS actuator and electric unit (control unit) harness connector		Continuity
Connector No.	Terminal No.	Connector No.	Terminal No.	
E30	15G	E26	26	Existed
	8G		15	Existed

Is the inspection result normal?

- YES (Present error)>>Check CAN system type decision again.
YES (Past error)>>Error was detected in the main line between the A/C auto amp. and the ABS actuator and electric unit (control unit).
NO >> Repair the main line between the harness connector E30 and the ABS actuator and electric unit (control unit).

MAIN LINE BETWEEN HVAC AND A-BAG CIRCUIT

< DTC/CIRCUIT DIAGNOSIS >

[CAN]

MAIN LINE BETWEEN HVAC AND A-BAG CIRCUIT

Diagnosis Procedure

INFOID:000000006234286

Regarding Wiring Diagram information, refer to [LAN-28. "Wiring Diagram"](#).

1. CHECK HARNESS CONTINUITY (OPEN CIRCUIT)

1. Turn the ignition switch OFF.
2. Disconnect the battery cable from the negative terminal.
3. Disconnect the following harness connectors.
 - A/C auto amp.
 - Harness connectors M1 and E30
4. Check the continuity between the harness connector and the A/C auto amp. harness connector.

A/C auto amp. harness connector		Harness connector		Continuity
Connector No.	Terminal No.	Connector No.	Terminal No.	
M37	1	M1	15G	Existed
	2		8G	Existed

Is the inspection result normal?

YES (Present error)>>Check CAN system type decision again.

YES (Past error)>>Error was detected in the main line between the A/C auto amp. and the air bag diagnosis sensor unit.

NO >> Repair the main line between the A/C auto amp. and the air bag diagnosis sensor unit.

LAN

MAIN LINE BETWEEN A-BAG AND ABS CIRCUIT

< DTC/CIRCUIT DIAGNOSIS >

[CAN]

MAIN LINE BETWEEN A-BAG AND ABS CIRCUIT

Diagnosis Procedure

INFOID:000000006234287

Regarding Wiring Diagram information, refer to [LAN-28. "Wiring Diagram"](#).

1. CHECK CONNECTOR

1. Turn the ignition switch OFF.
2. Disconnect the battery cable from the negative terminal.
3. Check the following terminals and connectors for damage, bend and loose connection (connector side and harness side).
 - Harness connector M1
 - Harness connector E30

Is the inspection result normal?

- YES >> GO TO 2.
NO >> Repair the terminal and connector.

2. CHECK HARNESS CONTINUITY (OPEN CIRCUIT)

1. Disconnect the following harness connectors.
 - A/C auto amp.
 - Harness connectors M1 and E30
2. Check the continuity between the A/C auto amp. harness connector and the harness connector.

A/C auto amp. harness connector		Harness connector		Continuity
Connector No.	Terminal No.	Connector No.	Terminal No.	
M37	1	M1	15G	Existed
	2		8G	Existed

Is the inspection result normal?

- YES >> GO TO 3.
NO >> Repair the main line between the air bag diagnosis sensor unit and the harness connector M1.

3. CHECK HARNESS CONTINUITY (OPEN CIRCUIT)

1. Disconnect the connector of ABS actuator and electric unit (control unit).
2. Check the continuity between the harness connector and the ABS actuator and electric unit (control unit) harness connector.

Harness connector		ABS actuator and electric unit (control unit) harness connector		Continuity
Connector No.	Terminal No.	Connector No.	Terminal No.	
E30	15G	E26	26	Existed
	8G		15	Existed

Is the inspection result normal?

- YES (Present error)>>Check CAN system type decision again.
YES (Past error)>>Error was detected in the main line between the air bag diagnosis sensor unit and the ABS actuator and electric unit (control unit).
NO >> Repair the main line between the harness connector E30 and the ABS actuator and electric unit (control unit).

ECM BRANCH LINE CIRCUIT

< DTC/CIRCUIT DIAGNOSIS >

[CAN]

ECM BRANCH LINE CIRCUIT

Diagnosis Procedure

INFOID:000000006234288

Regarding Wiring Diagram information, refer to [LAN-28. "Wiring Diagram"](#).

1. CHECK CONNECTOR

1. Turn the ignition switch OFF.
2. Disconnect the battery cable from the negative terminal.
3. Check the following terminals and connectors for damage, bend and loose connection (unit side and connector side).
 - Models without automatic drive positioner
 - ECM
 - Harness connector E30
 - Harness connector M1
 - Models with automatic drive positioner
 - ECM
 - Harness connector E29
 - Harness connector B10

Is the inspection result normal?

YES >> GO TO 2.

NO >> Repair the terminal and connector.

2. CHECK HARNESS FOR OPEN CIRCUIT

1. Disconnect the connector of ECM.
2. Check the resistance between the ECM harness connector terminals.

ECM harness connector		Resistance (Ω)
Connector No.	Terminal No.	
E10	98	Approx. 108 – 132
	97	

Is the measurement value within the specification?

YES >> GO TO 3.

NO >> Repair the ECM branch line.

3. CHECK POWER SUPPLY AND GROUND CIRCUIT

Check the power supply and the ground circuit of the ECM. Refer to [EC-154. "Diagnosis Procedure"](#).

Is the inspection result normal?

YES (Present error)>>Replace the ECM. Refer to [EC-17. "ADDITIONAL SERVICE WHEN REPLACING CONTROL UNIT : Description"](#).

YES (Past error)>>Error was detected in the ECM branch line.

NO >> Repair the power supply and the ground circuit.

A
B
C
D
E
F
G
H
I
J
K
L
N
O
P

LAN

ADP BRANCH LINE CIRCUIT

< DTC/CIRCUIT DIAGNOSIS >

[CAN]

ADP BRANCH LINE CIRCUIT

Diagnosis Procedure

INFOID:000000006234289

Regarding Wiring Diagram information, refer to [LAN-28. "Wiring Diagram"](#).

1. CHECK CONNECTOR

1. Turn the ignition switch OFF.
2. Disconnect the battery cable from the negative terminal.
3. Check the following terminals and connectors for damage, bend and loose connection (unit side and connector side).
 - Driver seat control unit
 - Harness connector B208
 - Harness connector B32

Is the inspection result normal?

- YES >> GO TO 2.
NO >> Repair the terminal and connector.

2. CHECK HARNESS FOR OPEN CIRCUIT

1. Disconnect the connector of driver seat control unit.
2. Check the resistance between the driver seat control unit harness connector terminals.

Driver seat control unit harness connector			Resistance (Ω)
Connector No.	Terminal No.		
B203	16	32	Approx. 54 – 66

Is the measurement value within the specification?

- YES >> GO TO 3.
NO >> Repair the driver seat control unit branch line.

3. CHECK POWER SUPPLY AND GROUND CIRCUIT

Check the power supply and the ground circuit of the driver seat control unit. Refer to [ADP-48. "DRIVER SEAT CONTROL UNIT : Diagnosis Procedure"](#).

Is the inspection result normal?

- YES (Present error)>>Replace the driver seat control unit. Refer to [ADP-171. "Removal and Installation"](#).
YES (Past error)>>Error was detected in the driver seat control unit branch line.
NO >> Repair the power supply and the ground circuit.

BCM BRANCH LINE CIRCUIT

< DTC/CIRCUIT DIAGNOSIS >

[CAN]

BCM BRANCH LINE CIRCUIT

Diagnosis Procedure

INFOID:000000006234290

Regarding Wiring Diagram information, refer to [LAN-28. "Wiring Diagram"](#).

1. CHECK CONNECTOR

1. Turn the ignition switch OFF.
2. Disconnect the battery cable from the negative terminal.
3. Check the terminals and connectors of the BCM for damage, bend and loose connection (unit side and connector side).

Is the inspection result normal?

YES >> GO TO 2.

NO >> Repair the terminal and connector.

2. CHECK HARNESS FOR OPEN CIRCUIT

1. Disconnect the connector of BCM.
2. Check the resistance between the BCM harness connector terminals.

BCM harness connector			Resistance (Ω)
Connector No.	Terminal No.		
M19	79	78	Approx. 54 – 66

Is the measurement value within the specification?

YES >> GO TO 3.

NO >> Repair the BCM branch line.

3. CHECK POWER SUPPLY AND GROUND CIRCUIT

Check the power supply and the ground circuit of the BCM. Refer to [BCS-36. "Diagnosis Procedure"](#).

Is the inspection result normal?

YES (Present error)>>Replace the BCM. Refer to [BCS-80. "Removal and Installation"](#).

YES (Past error)>>Error was detected in the BCM branch line.

NO >> Repair the power supply and the ground circuit.

A
B
C
D
E
F
G
H
I
J
K
L

LAN

N
O
P

DLC BRANCH LINE CIRCUIT

< DTC/CIRCUIT DIAGNOSIS >

[CAN]

DLC BRANCH LINE CIRCUIT

Diagnosis Procedure

INFOID:000000006234291

Regarding Wiring Diagram information, refer to [LAN-28. "Wiring Diagram"](#).

1. CHECK CONNECTOR

1. Turn the ignition switch OFF.
2. Disconnect the battery cable from the negative terminal.
3. Check the terminals and connectors of the data link connector for damage, bend and loose connection (connector side and harness side).

Is the inspection result normal?

YES >> GO TO 2.

NO >> Repair the terminal and connector.

2. CHECK HARNESS FOR OPEN CIRCUIT

Check the resistance between the data link connector terminals.

Data link connector			Resistance (Ω)
Connector No.	Terminal No.		
M22	6	14	Approx. 54 – 66

Is the measurement value within the specification?

YES (Present error)>>Check CAN system type decision again.

YES (Past error)>>Error was detected in the data link connector branch line circuit.

NO >> Repair the data link connector branch line.

M&A BRANCH LINE CIRCUIT

< DTC/CIRCUIT DIAGNOSIS >

[CAN]

M&A BRANCH LINE CIRCUIT

Diagnosis Procedure

INFOID:000000006234292

Regarding Wiring Diagram information, refer to [LAN-28. "Wiring Diagram"](#).

1. CHECK CONNECTOR

1. Turn the ignition switch OFF.
2. Disconnect the battery cable from the negative terminal.
3. Check the terminals and connectors of the combination meter for damage, bend and loose connection (unit side and connector side).

Is the inspection result normal?

YES >> GO TO 2.

NO >> Repair the terminal and connector.

2. CHECK HARNESS FOR OPEN CIRCUIT

1. Disconnect the connector of combination meter.
2. Check the resistance between the combination meter harness connector terminals.

Combination meter harness connector			Resistance (Ω)
Connector No.	Terminal No.		
M24	21	22	Approx. 54 – 66

Is the measurement value within the specification?

YES >> GO TO 3.

NO >> Repair the combination meter branch line.

3. CHECK POWER SUPPLY AND GROUND CIRCUIT

Check the power supply and the ground circuit of the combination meter. Refer to [MWI-37. "COMBINATION METER : Diagnosis Procedure"](#).

Is the inspection result normal?

YES (Present error)>>Replace the combination meter. Refer to [MWI-119. "Removal and Installation"](#).

YES (Past error)>>Error was detected in the combination meter branch line.

NO >> Repair the power supply and the ground circuit.

A
B
C
D
E
F
G
H
I
J
K
L

LAN

N
O
P

AV BRANCH LINE CIRCUIT

< DTC/CIRCUIT DIAGNOSIS >

[CAN]

AV BRANCH LINE CIRCUIT

Diagnosis Procedure

INFOID:000000006234293

Regarding Wiring Diagram information, refer to [LAN-28, "Wiring Diagram"](#).

1. CHECK CONNECTOR

1. Turn the ignition switch OFF.
2. Disconnect the battery cable from the negative terminal.
3. Check the terminals and connectors of the AV control unit for damage, bend and loose connection (unit side and connector side).

Is the inspection result normal?

YES >> GO TO 2.

NO >> Repair the terminal and connector.

2. CHECK HARNESS FOR OPEN CIRCUIT

1. Disconnect the connector of AV control unit.
 2. Check the resistance between the AV control unit harness connector terminals.
- Models without navigation system

AV control unit harness connector			Resistance (Ω)
Connector No.	Terminal No.		
M156	86	87	Approx. 54 – 66

- Models with navigation system

AV control unit harness connector			Resistance (Ω)
Connector No.	Terminal No.		
M163	62	46	Approx. 54 – 66

Is the measurement value within the specification?

YES >> GO TO 3.

NO >> Repair the AV control unit branch line.

3. CHECK POWER SUPPLY AND GROUND CIRCUIT

Check the power supply and the ground circuit of the AV control unit. Refer to the following.

- Models with BOSE audio with color display: [AV-231, "AV CONTROL UNIT : Diagnosis Procedure"](#)
- Models with BOSE audio with color display with navigation system: [AV-411, "AV CONTROL UNIT : Diagnosis Procedure"](#)

Is the inspection result normal?

YES (Present error)>>Replace the AV control unit. Refer to the following.

- Models with BOSE audio with color display: [AV-321, "Removal and Installation"](#)
- Models with BOSE audio with color display with navigation system: [AV-489, "Removal and Installation"](#)

YES (Past error)>>Error was detected in the AV control unit branch line.

NO >> Repair the power supply and the ground circuit.

HVAC BRANCH LINE CIRCUIT

< DTC/CIRCUIT DIAGNOSIS >

[CAN]

HVAC BRANCH LINE CIRCUIT

Diagnosis Procedure

INFOID:000000006234294

Regarding Wiring Diagram information, refer to [LAN-28, "Wiring Diagram"](#).

1. CHECK CONNECTOR

1. Turn the ignition switch OFF.
2. Disconnect the battery cable from the negative terminal.
3. Check the terminals and connectors of the A/C auto amp. for damage, bend and loose connection (unit side and connector side).

Is the inspection result normal?

YES >> GO TO 2.

NO >> Repair the terminal and connector.

2. CHECK HARNESS FOR OPEN CIRCUIT

1. Disconnect the connector of A/C auto amp.
2. Check the resistance between the A/C auto amp. harness connector terminals.

A/C auto amp. harness connector			Resistance (Ω)
Connector No.	Terminal No.		
M37	1	2	Approx. 54 – 66

Is the measurement value within the specification?

YES >> GO TO 3.

NO >> Repair the A/C auto amp. branch line.

3. CHECK POWER SUPPLY AND GROUND CIRCUIT

Check the power supply and the ground circuit of the A/C auto amp. Refer to the following.

- Models with color display: [HAC-60, "A/C AUTO AMP. : Diagnosis Procedure"](#)
- Models with monochrome display: [HAC-168, "A/C AUTO AMP. : Diagnosis Procedure"](#)

Is the inspection result normal?

YES (Present error)>>Replace the A/C auto amp. Refer to the following.

- Models with color display: [HAC-104, "Removal and Installation"](#)
- Models monochrome display: [HAC-212, "Removal and Installation"](#)

YES (Past error)>>Error was detected in the A/C auto amp. branch line.

NO >> Repair the power supply and the ground circuit.

LAN

STRG BRANCH LINE CIRCUIT

< DTC/CIRCUIT DIAGNOSIS >

[CAN]

STRG BRANCH LINE CIRCUIT

Diagnosis Procedure

INFOID:000000006234295

Regarding Wiring Diagram information, refer to [LAN-28. "Wiring Diagram"](#).

1. CHECK CONNECTOR

1. Turn the ignition switch OFF.
2. Disconnect the battery cable from the negative terminal.
3. Check the terminals and connectors of the steering angle sensor for damage, bend and loose connection (unit side and connector side).

Is the inspection result normal?

- YES >> GO TO 2.
NO >> Repair the terminal and connector.

2. CHECK HARNESS FOR OPEN CIRCUIT

1. Disconnect the connector of steering angle sensor.
2. Check the resistance between the steering angle sensor harness connector terminals.

Steering angle sensor harness connector			Resistance (Ω)
Connector No.	Terminal No.		
M53	5	2	Approx. 54 – 66

Is the measurement value within the specification?

- YES >> GO TO 3.
NO >> Repair the steering angle sensor branch line.

3. CHECK POWER SUPPLY AND GROUND CIRCUIT

Check the power supply and the ground circuit of the steering angle sensor. Refer to [BRC-86. "Wiring Diagram"](#).

Is the inspection result normal?

- YES (Present error)>>Replace the steering angle sensor. Refer to [BRC-110. "Removal and Installation"](#).
YES (Past error)>>Error was detected in the steering angle sensor branch line.
NO >> Repair the power supply and the ground circuit.

A-BAG BRANCH LINE CIRCUIT

< DTC/CIRCUIT DIAGNOSIS >

[CAN]

A-BAG BRANCH LINE CIRCUIT

Diagnosis Procedure

INFOID:000000006234296

WARNING:

- Before servicing, turn ignition switch OFF, disconnect battery negative terminal, and wait 3 minutes or more. (To discharge backup capacitor.)
- Never use unspecified tester or other measuring device.

1. CHECK CONNECTOR

Check the terminals and connectors of the air bag diagnosis sensor unit for damage, bend and loose connection (unit side and connector side).

Is the inspection result normal?

YES >> GO TO 2.

NO >> Replace the terminal and connector.

2. CHECK AIR BAG DIAGNOSIS SENSOR UNIT

Check the air bag diagnosis sensor unit. Refer to [SRC-3, "Work Flow"](#).

Is the inspection result normal?

YES >> Replace the main harness.

NO >> Replace parts whose air bag system has a malfunction.

A
B
C
D
E
F
G
H
I
J
K
L
N
O
P

LAN

ABS BRANCH LINE CIRCUIT

< DTC/CIRCUIT DIAGNOSIS >

[CAN]

ABS BRANCH LINE CIRCUIT

Diagnosis Procedure

INFOID:000000006234297

Regarding Wiring Diagram information, refer to [LAN-28, "Wiring Diagram"](#).

1. CHECK CONNECTOR

1. Turn the ignition switch OFF.
2. Disconnect the battery cable from the negative terminal.
3. Check the terminals and connectors of the ABS actuator and electric unit (control unit) for damage, bend and loose connection (unit side and connector side).

Is the inspection result normal?

- YES >> GO TO 2.
NO >> Repair the terminal and connector.

2. CHECK HARNESS FOR OPEN CIRCUIT

1. Disconnect the connector of ABS actuator and electric unit (control unit).
2. Check the resistance between the ABS actuator and electric unit (control unit) harness connector terminals.

ABS actuator and electric unit (control unit) harness connector			Resistance (Ω)
Connector No.	Terminal No.		
E26	26	15	Approx. 54 – 66

Is the measurement value within the specification?

- YES >> GO TO 3.
NO >> Repair the ABS actuator and electric unit (control unit) branch line.

3. CHECK POWER SUPPLY AND GROUND CIRCUIT

Check the power supply and the ground circuit of the ABS actuator and electric unit (control unit). Refer to [BRC-86, "Wiring Diagram"](#).

Is the inspection result normal?

- YES (Present error)>>Replace the ABS actuator and electric unit (control unit). Refer to [BRC-107, "Exploded View"](#).
YES (Past error)>>Error was detected in the ABS actuator and electric unit (control unit) branch line.
NO >> Repair the power supply and the ground circuit.

TCM BRANCH LINE CIRCUIT

< DTC/CIRCUIT DIAGNOSIS >

[CAN]

TCM BRANCH LINE CIRCUIT

Diagnosis Procedure

INFOID:000000006234298

Regarding Wiring Diagram information, refer to [LAN-28. "Wiring Diagram"](#).

1. CHECK CONNECTOR

1. Turn the ignition switch OFF.
2. Disconnect the battery cable from the negative terminal.
3. Check the following terminals and connectors for damage, bend and loose connection (unit side and connector side).
 - TCM
 - Harness connector F1
 - Harness connector E3

Is the inspection result normal?

- YES >> GO TO 2.
NO >> Repair the terminal and connector.

2. CHECK HARNESS FOR OPEN CIRCUIT

1. Disconnect the connector of TCM.
2. Check the resistance between the TCM harness connector terminals.

TCM harness connector			Resistance (Ω)
Connector No.	Terminal No.		
F15	32	31	Approx. 54 – 66

Is the measurement value within the specification?

- YES >> GO TO 3.
NO >> Repair the TCM branch line.

3. CHECK POWER SUPPLY AND GROUND CIRCUIT

Check the power supply and the ground circuit of the TCM. Refer to [TM-119. "Wiring Diagram"](#).

Is the inspection result normal?

- YES (Present error)>>Replace the TCM. Refer to [TM-161. "Exploded View"](#).
YES (Past error)>>Error was detected in the TCM branch line.
NO >> Repair the power supply and the ground circuit.

A
B
C
D
E
F
G
H
I
J
K
L
N
O
P

LAN

IPDM-E BRANCH LINE CIRCUIT

< DTC/CIRCUIT DIAGNOSIS >

[CAN]

IPDM-E BRANCH LINE CIRCUIT

Diagnosis Procedure

INFOID:000000006234299

Regarding Wiring Diagram information, refer to [LAN-28. "Wiring Diagram"](#).

1. CHECK CONNECTOR

1. Turn the ignition switch OFF.
2. Disconnect the battery cable from the negative terminal.
3. Check the terminals and connectors of the IPDM E/R for damage, bend and loose connection (unit side and connector side).

Is the inspection result normal?

- YES >> GO TO 2.
NO >> Repair the terminal and connector.

2. CHECK HARNESS FOR OPEN CIRCUIT

1. Disconnect the connector of IPDM E/R.
2. Check the resistance between the IPDM E/R harness connector terminals.

IPDM E/R harness connector			Resistance (Ω)
Connector No.	Terminal No.		
E17	40	39	Approx. 108 – 132

Is the measurement value within the specification?

- YES >> GO TO 3.
NO >> Repair the IPDM E/R branch line.

3. CHECK POWER SUPPLY AND GROUND CIRCUIT

Check the power supply and the ground circuit of the IPDM E/R. Refer to [PCS-18. "Diagnosis Procedure"](#).

Is the inspection result normal?

- YES (Present error)>>Replace the IPDM E/R. Refer to [PCS-35. "Removal and Installation"](#).
YES (Past error)>>Error was detected in the IPDM E/R branch line.
NO >> Repair the power supply and the ground circuit.

CAN COMMUNICATION CIRCUIT

[CAN]

< DTC/CIRCUIT DIAGNOSIS >

CAN COMMUNICATION CIRCUIT

Diagnosis Procedure

INFOID:000000006234300

Regarding Wiring Diagram information, refer to [LAN-28. "Wiring Diagram"](#).

1. CONNECTOR INSPECTION

1. Turn the ignition switch OFF.
2. Disconnect the battery cable from the negative terminal.
3. Disconnect all the unit connectors on CAN communication system.
4. Check terminals and connectors for damage, bend and loose connection.

Is the inspection result normal?

- YES >> GO TO 2.
NO >> Repair the terminal and connector.

2. CHECK HARNESS CONTINUITY (SHORT CIRCUIT)

Check the continuity between the data link connector terminals.

Data link connector		Continuity
Connector No.	Terminal No.	
M22	6	Not existed
	14	

Is the inspection result normal?

- YES >> GO TO 3.
NO >> Check the harness and repair the root cause.

3. CHECK HARNESS CONTINUITY (SHORT CIRCUIT)

Check the continuity between the data link connector and the ground.

Data link connector		Ground	Continuity
Connector No.	Terminal No.		
M22	6		Not existed
	14		Not existed

Is the inspection result normal?

- YES >> GO TO 4.
NO >> Check the harness and repair the root cause.

4. CHECK ECM AND IPDM E/R TERMINATION CIRCUIT

1. Remove the ECM and the IPDM E/R.
2. Check the resistance between the ECM terminals.

ECM		Resistance (Ω)
Terminal No.		
98	97	Approx. 108 – 132

3. Check the resistance between the IPDM E/R terminals.

IPDM E/R		Resistance (Ω)
Terminal No.		
40	39	Approx. 108 – 132

Is the measurement value within the specification?

- YES >> GO TO 5.
NO >> Replace the ECM and/or the IPDM E/R.

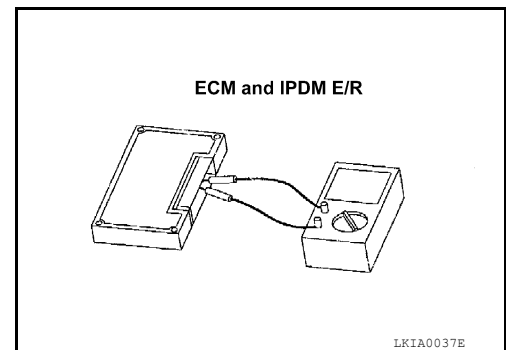

A
B
C
D
E
F
G
H
I
J
K
L
N
O
P

LAN

CAN COMMUNICATION CIRCUIT

< DTC/CIRCUIT DIAGNOSIS >

[CAN]

5.CHECK SYMPTOM

Connect all the connectors. Check if the symptoms described in the “Symptom (Results from interview with customer)” are reproduced.

Inspection result

Reproduced>>GO TO 6.

Non-reproduced>>Start the diagnosis again. Follow the trouble diagnosis procedure when past error is detected.

6.CHECK UNIT REPRODUCTION

Perform the reproduction test as per the following procedure for each unit.

1. Turn the ignition switch OFF.
2. Disconnect the battery cable from the negative terminal.
3. Disconnect one of the unit connectors of CAN communication system.

NOTE:

ECM and IPDM E/R have a termination circuit. Check other units first.

4. Connect the battery cable to the negative terminal. Check if the symptoms described in the “Symptom (Results from interview with customer)” are reproduced.

NOTE:

Although unit-related error symptoms occur, do not confuse them with other symptoms.

Inspection result

Reproduced>>Connect the connector. Check other units as per the above procedure.

Non-reproduced>>Replace the unit whose connector was disconnected.

MAIN LINE BETWEEN DLC AND HVAC CIRCUIT

< DTC/CIRCUIT DIAGNOSIS >

[CAN SYSTEM (TYPE 1)]

DTC/CIRCUIT DIAGNOSIS

MAIN LINE BETWEEN DLC AND HVAC CIRCUIT

Diagnosis Procedure

INFOID:000000006234301

Regarding Wiring Diagram information, refer to [LAN-28. "Wiring Diagram"](#).

1. CHECK HARNESS CONTINUITY (OPEN CIRCUIT)

1. Turn the ignition switch OFF.
2. Disconnect the battery cable from the negative terminal.
3. Disconnect the following harness connectors.
 - ECM
 - A/C auto amp.
4. Check the continuity between the data link connector and the A/C auto amp. harness connector.

Data link connector		A/C auto amp. harness connector		Continuity
Connector No.	Terminal No.	Connector No.	Terminal No.	
M22	6	M37	1	Existed
	14		2	Existed

Is the inspection result normal?

YES (Present error)>>Check CAN system type decision again.

YES (Past error)>>Error was detected in the main line between the data link connector and the A/C auto amp.

NO >> Repair the main line between the data link connector and the A/C auto amp.

LAN

MAIN LINE BETWEEN HVAC AND A-BAG CIRCUIT

< DTC/CIRCUIT DIAGNOSIS >

[CAN SYSTEM (TYPE 1)]

MAIN LINE BETWEEN HVAC AND A-BAG CIRCUIT

Diagnosis Procedure

INFOID:000000006234302

Regarding Wiring Diagram information, refer to [LAN-28. "Wiring Diagram"](#).

1. CHECK HARNESS CONTINUITY (OPEN CIRCUIT)

1. Turn the ignition switch OFF.
2. Disconnect the battery cable from the negative terminal.
3. Disconnect the following harness connectors.
 - A/C auto amp.
 - Harness connectors M1 and E30
4. Check the continuity between the harness connector and the A/C auto amp. harness connector.

A/C auto amp. harness connector		Harness connector		Continuity
Connector No.	Terminal No.	Connector No.	Terminal No.	
M37	1	M1	15G	Existed
	2		8G	Existed

Is the inspection result normal?

YES (Present error)>>Check CAN system type decision again.

YES (Past error)>>Error was detected in the main line between the A/C auto amp. and the air bag diagnosis sensor unit.

NO >> Repair the main line between the A/C auto amp. and the air bag diagnosis sensor unit.

MAIN LINE BETWEEN A-BAG AND ABS CIRCUIT

< DTC/CIRCUIT DIAGNOSIS >

[CAN SYSTEM (TYPE 1)]

MAIN LINE BETWEEN A-BAG AND ABS CIRCUIT

Diagnosis Procedure

INFOID:000000006234303

Regarding Wiring Diagram information, refer to [LAN-28. "Wiring Diagram"](#).

1. CHECK CONNECTOR

1. Turn the ignition switch OFF.
2. Disconnect the battery cable from the negative terminal.
3. Check the following terminals and connectors for damage, bend and loose connection (connector side and harness side).
 - Harness connector M1
 - Harness connector E30

Is the inspection result normal?

YES >> GO TO 2.

NO >> Repair the terminal and connector.

2. CHECK HARNESS CONTINUITY (OPEN CIRCUIT)

1. Disconnect the following harness connectors.
 - A/C auto amp.
 - Harness connectors M1 and E30
2. Check the continuity between the A/C auto amp. harness connector and the harness connector.

A/C auto amp. harness connector		Harness connector		Continuity
Connector No.	Terminal No.	Connector No.	Terminal No.	
M37	1	M1	15G	Existed
	2		8G	Existed

Is the inspection result normal?

YES >> GO TO 3.

NO >> Repair the main line between the air bag diagnosis sensor unit and the harness connector M1.

3. CHECK HARNESS CONTINUITY (OPEN CIRCUIT)

1. Disconnect the connector of ABS actuator and electric unit (control unit).
2. Check the continuity between the harness connector and the ABS actuator and electric unit (control unit) harness connector.

Harness connector		ABS actuator and electric unit (control unit) harness connector		Continuity
Connector No.	Terminal No.	Connector No.	Terminal No.	
E30	15G	E26	26	Existed
	8G		15	Existed

Is the inspection result normal?

YES (Present error)>>Check CAN system type decision again.

YES (Past error)>>Error was detected in the main line between the air bag diagnosis sensor unit and the ABS actuator and electric unit (control unit).

NO >> Repair the main line between the harness connector E30 and the ABS actuator and electric unit (control unit).

ECM BRANCH LINE CIRCUIT

Diagnosis Procedure

INFOID:000000006234304

Regarding Wiring Diagram information, refer to [LAN-28, "Wiring Diagram"](#).

1. CHECK CONNECTOR

1. Turn the ignition switch OFF.
2. Disconnect the battery cable from the negative terminal.
3. Check the following terminals and connectors for damage, bend and loose connection (unit side and connector side).
 - Models without automatic drive positioner
 - ECM
 - Harness connector E30
 - Harness connector M1
 - Models with automatic drive positioner
 - ECM
 - Harness connector E29
 - Harness connector B10

Is the inspection result normal?

- YES >> GO TO 2.
 NO >> Repair the terminal and connector.

2. CHECK HARNESS FOR OPEN CIRCUIT

1. Disconnect the connector of ECM.
2. Check the resistance between the ECM harness connector terminals.

ECM harness connector			Resistance (Ω)
Connector No.	Terminal No.		
E10	98	97	Approx. 108 – 132

Is the measurement value within the specification?

- YES >> GO TO 3.
 NO >> Repair the ECM branch line.

3. CHECK POWER SUPPLY AND GROUND CIRCUIT

Check the power supply and the ground circuit of the ECM. Refer to [EC-154, "Diagnosis Procedure"](#).

Is the inspection result normal?

- YES (Present error)>>Replace the ECM. Refer to [EC-17, "ADDITIONAL SERVICE WHEN REPLACING CONTROL UNIT : Description"](#).
 YES (Past error)>>Error was detected in the ECM branch line.
 NO >> Repair the power supply and the ground circuit.

BCM BRANCH LINE CIRCUIT

Diagnosis Procedure

INFOID:000000006234305

Regarding Wiring Diagram information, refer to [LAN-28. "Wiring Diagram"](#).

1. CHECK CONNECTOR

1. Turn the ignition switch OFF.
2. Disconnect the battery cable from the negative terminal.
3. Check the terminals and connectors of the BCM for damage, bend and loose connection (unit side and connector side).

Is the inspection result normal?

- YES >> GO TO 2.
 NO >> Repair the terminal and connector.

2. CHECK HARNESS FOR OPEN CIRCUIT

1. Disconnect the connector of BCM.
2. Check the resistance between the BCM harness connector terminals.

BCM harness connector			Resistance (Ω)
Connector No.	Terminal No.		
M19	79	78	Approx. 54 – 66

Is the measurement value within the specification?

- YES >> GO TO 3.
 NO >> Repair the BCM branch line.

3. CHECK POWER SUPPLY AND GROUND CIRCUIT

Check the power supply and the ground circuit of the BCM. Refer to [BCS-36. "Diagnosis Procedure"](#).

Is the inspection result normal?

- YES (Present error)>>Replace the BCM. Refer to [BCS-80. "Removal and Installation"](#).
 YES (Past error)>>Error was detected in the BCM branch line.
 NO >> Repair the power supply and the ground circuit.

A
B
C
D
E
F
G
H
I
J
K
L

LAN

DLC BRANCH LINE CIRCUIT

Diagnosis Procedure

INFOID:000000006234306

Regarding Wiring Diagram information, refer to [LAN-28. "Wiring Diagram"](#).

1. CHECK CONNECTOR

1. Turn the ignition switch OFF.
2. Disconnect the battery cable from the negative terminal.
3. Check the terminals and connectors of the data link connector for damage, bend and loose connection (connector side and harness side).

Is the inspection result normal?

- YES >> GO TO 2.
 NO >> Repair the terminal and connector.

2. CHECK HARNESS FOR OPEN CIRCUIT

Check the resistance between the data link connector terminals.

Data link connector			Resistance (Ω)
Connector No.	Terminal No.		
M22	6	14	Approx. 54 – 66

Is the measurement value within the specification?

- YES (Present error)>>Check CAN system type decision again.
 YES (Past error)>>Error was detected in the data link connector branch line circuit.
 NO >> Repair the data link connector branch line.

M&A BRANCH LINE CIRCUIT

Diagnosis Procedure

INFOID:000000006234307

Regarding Wiring Diagram information, refer to [LAN-28. "Wiring Diagram"](#).

1. CHECK CONNECTOR

1. Turn the ignition switch OFF.
2. Disconnect the battery cable from the negative terminal.
3. Check the terminals and connectors of the combination meter for damage, bend and loose connection (unit side and connector side).

Is the inspection result normal?

- YES >> GO TO 2.
 NO >> Repair the terminal and connector.

2. CHECK HARNESS FOR OPEN CIRCUIT

1. Disconnect the connector of combination meter.
2. Check the resistance between the combination meter harness connector terminals.

Combination meter harness connector			Resistance (Ω)
Connector No.	Terminal No.		
M24	21	22	Approx. 54 – 66

Is the measurement value within the specification?

- YES >> GO TO 3.
 NO >> Repair the combination meter branch line.

3. CHECK POWER SUPPLY AND GROUND CIRCUIT

Check the power supply and the ground circuit of the combination meter. Refer to [MWI-37. "COMBINATION METER : Diagnosis Procedure"](#).

Is the inspection result normal?

- YES (Present error)>>Replace the combination meter. Refer to [MWI-119. "Removal and Installation"](#).
 YES (Past error)>>Error was detected in the combination meter branch line.
 NO >> Repair the power supply and the ground circuit.

A
B
C
D
E
F
G
H
I
J
K
L

LAN

HVAC BRANCH LINE CIRCUIT

Diagnosis Procedure

INFOID:000000006234308

Regarding Wiring Diagram information, refer to [LAN-28, "Wiring Diagram"](#).

1. CHECK CONNECTOR

1. Turn the ignition switch OFF.
2. Disconnect the battery cable from the negative terminal.
3. Check the terminals and connectors of the A/C auto amp. for damage, bend and loose connection (unit side and connector side).

Is the inspection result normal?

- YES >> GO TO 2.
 NO >> Repair the terminal and connector.

2. CHECK HARNESS FOR OPEN CIRCUIT

1. Disconnect the connector of A/C auto amp.
2. Check the resistance between the A/C auto amp. harness connector terminals.

A/C auto amp. harness connector			Resistance (Ω)
Connector No.	Terminal No.		
M37	1	2	Approx. 54 – 66

Is the measurement value within the specification?

- YES >> GO TO 3.
 NO >> Repair the A/C auto amp. branch line.

3. CHECK POWER SUPPLY AND GROUND CIRCUIT

Check the power supply and the ground circuit of the A/C auto amp. Refer to the following.

- Models with color display: [HAC-60, "A/C AUTO AMP. : Diagnosis Procedure"](#)
- Models with monochrome display: [HAC-168, "A/C AUTO AMP. : Diagnosis Procedure"](#)

Is the inspection result normal?

- YES (Present error)>>Replace the A/C auto amp. Refer to the following.
- Models with color display: [HAC-104, "Removal and Installation"](#)
 - Models monochrome display: [HAC-212, "Removal and Installation"](#)
- YES (Past error)>>Error was detected in the A/C auto amp. branch line.
 NO >> Repair the power supply and the ground circuit.

STRG BRANCH LINE CIRCUIT

< DTC/CIRCUIT DIAGNOSIS >

[CAN SYSTEM (TYPE 1)]

STRG BRANCH LINE CIRCUIT

Diagnosis Procedure

INFOID:00000006234309

Regarding Wiring Diagram information, refer to [LAN-28. "Wiring Diagram"](#).

1. CHECK CONNECTOR

1. Turn the ignition switch OFF.
2. Disconnect the battery cable from the negative terminal.
3. Check the terminals and connectors of the steering angle sensor for damage, bend and loose connection (unit side and connector side).

Is the inspection result normal?

YES >> GO TO 2.

NO >> Repair the terminal and connector.

2. CHECK HARNESS FOR OPEN CIRCUIT

1. Disconnect the connector of steering angle sensor.
2. Check the resistance between the steering angle sensor harness connector terminals.

Steering angle sensor harness connector			Resistance (Ω)
Connector No.	Terminal No.		
M53	5	2	Approx. 54 – 66

Is the measurement value within the specification?

YES >> GO TO 3.

NO >> Repair the steering angle sensor branch line.

3. CHECK POWER SUPPLY AND GROUND CIRCUIT

Check the power supply and the ground circuit of the steering angle sensor. Refer to [BRC-86. "Wiring Diagram"](#).

Is the inspection result normal?

YES (Present error)>>Replace the steering angle sensor. Refer to [BRC-110. "Removal and Installation"](#).

YES (Past error)>>Error was detected in the steering angle sensor branch line.

NO >> Repair the power supply and the ground circuit.

A
B
C
D
E
F
G
H
I
J
K
L

LAN

N
O
P

A-BAG BRANCH LINE CIRCUIT

< DTC/CIRCUIT DIAGNOSIS >

[CAN SYSTEM (TYPE 1)]

A-BAG BRANCH LINE CIRCUIT

Diagnosis Procedure

INFOID:000000006234310

WARNING:

- Before servicing, turn ignition switch OFF, disconnect battery negative terminal, and wait 3 minutes or more. (To discharge backup capacitor.)
- Never use unspecified tester or other measuring device.

1.CHECK CONNECTOR

Check the terminals and connectors of the air bag diagnosis sensor unit for damage, bend and loose connection (unit side and connector side).

Is the inspection result normal?

YES >> GO TO 2.

NO >> Replace the terminal and connector.

2.CHECK AIR BAG DIAGNOSIS SENSOR UNIT

Check the air bag diagnosis sensor unit. Refer to [SRC-3, "Work Flow"](#).

Is the inspection result normal?

YES >> Replace the main harness.

NO >> Replace parts whose air bag system has a malfunction.

ABS BRANCH LINE CIRCUIT

< DTC/CIRCUIT DIAGNOSIS >

[CAN SYSTEM (TYPE 1)]

ABS BRANCH LINE CIRCUIT

Diagnosis Procedure

INFOID:000000006234311

Regarding Wiring Diagram information, refer to [LAN-28. "Wiring Diagram"](#).

1. CHECK CONNECTOR

1. Turn the ignition switch OFF.
2. Disconnect the battery cable from the negative terminal.
3. Check the terminals and connectors of the ABS actuator and electric unit (control unit) for damage, bend and loose connection (unit side and connector side).

Is the inspection result normal?

YES >> GO TO 2.

NO >> Repair the terminal and connector.

2. CHECK HARNESS FOR OPEN CIRCUIT

1. Disconnect the connector of ABS actuator and electric unit (control unit).
2. Check the resistance between the ABS actuator and electric unit (control unit) harness connector terminals.

ABS actuator and electric unit (control unit) harness connector			Resistance (Ω)
Connector No.	Terminal No.		
E26	26	15	Approx. 54 – 66

Is the measurement value within the specification?

YES >> GO TO 3.

NO >> Repair the ABS actuator and electric unit (control unit) branch line.

3. CHECK POWER SUPPLY AND GROUND CIRCUIT

Check the power supply and the ground circuit of the ABS actuator and electric unit (control unit). Refer to [BRC-86. "Wiring Diagram"](#).

Is the inspection result normal?

YES (Present error)>>Replace the ABS actuator and electric unit (control unit). Refer to [BRC-107. "Exploded View"](#).

YES (Past error)>>Error was detected in the ABS actuator and electric unit (control unit) branch line.

NO >> Repair the power supply and the ground circuit.

A
B
C
D
E
F
G
H
I
J
K
L

LAN

TCM BRANCH LINE CIRCUIT

Diagnosis Procedure

INFOID:00000006234312

Regarding Wiring Diagram information, refer to [LAN-28, "Wiring Diagram"](#).

1. CHECK CONNECTOR

1. Turn the ignition switch OFF.
2. Disconnect the battery cable from the negative terminal.
3. Check the following terminals and connectors for damage, bend and loose connection (unit side and connector side).
 - TCM
 - Harness connector F1
 - Harness connector E3

Is the inspection result normal?

- YES >> GO TO 2.
 NO >> Repair the terminal and connector.

2. CHECK HARNESS FOR OPEN CIRCUIT

1. Disconnect the connector of TCM.
2. Check the resistance between the TCM harness connector terminals.

TCM harness connector			Resistance (Ω)
Connector No.	Terminal No.		
F15	32	31	Approx. 54 – 66

Is the measurement value within the specification?

- YES >> GO TO 3.
 NO >> Repair the TCM branch line.

3. CHECK POWER SUPPLY AND GROUND CIRCUIT

Check the power supply and the ground circuit of the TCM. Refer to [TM-119, "Wiring Diagram"](#).

Is the inspection result normal?

- YES (Present error)>>Replace the TCM. Refer to [TM-161, "Exploded View"](#).
 YES (Past error)>>Error was detected in the TCM branch line.
 NO >> Repair the power supply and the ground circuit.

IPDM-E BRANCH LINE CIRCUIT

Diagnosis Procedure

INFOID:000000006234313

Regarding Wiring Diagram information, refer to [LAN-28, "Wiring Diagram"](#).

1.CHECK CONNECTOR

1. Turn the ignition switch OFF.
2. Disconnect the battery cable from the negative terminal.
3. Check the terminals and connectors of the IPDM E/R for damage, bend and loose connection (unit side and connector side).

Is the inspection result normal?

- YES >> GO TO 2.
 NO >> Repair the terminal and connector.

2.CHECK HARNESS FOR OPEN CIRCUIT

1. Disconnect the connector of IPDM E/R.
2. Check the resistance between the IPDM E/R harness connector terminals.

IPDM E/R harness connector			Resistance (Ω)
Connector No.	Terminal No.		
E17	40	39	Approx. 108 – 132

Is the measurement value within the specification?

- YES >> GO TO 3.
 NO >> Repair the IPDM E/R branch line.

3.CHECK POWER SUPPLY AND GROUND CIRCUIT

Check the power supply and the ground circuit of the IPDM E/R. Refer to [PCS-18, "Diagnosis Procedure"](#).

Is the inspection result normal?

- YES (Present error)>>Replace the IPDM E/R. Refer to [PCS-35, "Removal and Installation"](#).
 YES (Past error)>>Error was detected in the IPDM E/R branch line.
 NO >> Repair the power supply and the ground circuit.

LAN

CAN COMMUNICATION CIRCUIT

< DTC/CIRCUIT DIAGNOSIS >

[CAN SYSTEM (TYPE 1)]

CAN COMMUNICATION CIRCUIT

Diagnosis Procedure

INFOID:00000006234314

Regarding Wiring Diagram information, refer to [LAN-28. "Wiring Diagram"](#).

1. CONNECTOR INSPECTION

1. Turn the ignition switch OFF.
2. Disconnect the battery cable from the negative terminal.
3. Disconnect all the unit connectors on CAN communication system.
4. Check terminals and connectors for damage, bend and loose connection.

Is the inspection result normal?

- YES >> GO TO 2.
NO >> Repair the terminal and connector.

2. CHECK HARNESS CONTINUITY (SHORT CIRCUIT)

Check the continuity between the data link connector terminals.

Data link connector			Continuity
Connector No.	Terminal No.		
M22	6	14	Not existed

Is the inspection result normal?

- YES >> GO TO 3.
NO >> Check the harness and repair the root cause.

3. CHECK HARNESS CONTINUITY (SHORT CIRCUIT)

Check the continuity between the data link connector and the ground.

Data link connector		Ground	Continuity
Connector No.	Terminal No.		
M22	6		Not existed
	14		Not existed

Is the inspection result normal?

- YES >> GO TO 4.
NO >> Check the harness and repair the root cause.

4. CHECK ECM AND IPDM E/R TERMINATION CIRCUIT

1. Remove the ECM and the IPDM E/R.
2. Check the resistance between the ECM terminals.

ECM		Resistance (Ω)
Terminal No.		
98	97	Approx. 108 – 132

3. Check the resistance between the IPDM E/R terminals.

IPDM E/R		Resistance (Ω)
Terminal No.		
40	39	Approx. 108 – 132

Is the measurement value within the specification?

- YES >> GO TO 5.
NO >> Replace the ECM and/or the IPDM E/R.

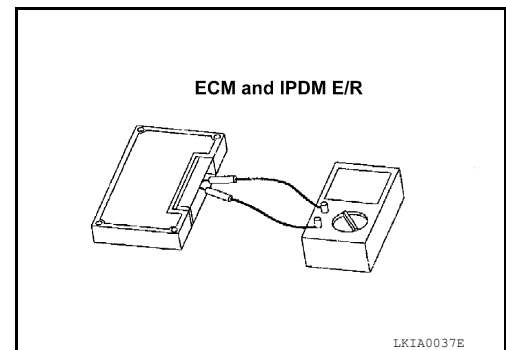

CAN COMMUNICATION CIRCUIT

< DTC/CIRCUIT DIAGNOSIS >

[CAN SYSTEM (TYPE 1)]

5.CHECK SYMPTOM

Connect all the connectors. Check if the symptoms described in the “Symptom (Results from interview with customer)” are reproduced.

Inspection result

Reproduced>>GO TO 6.

Non-reproduced>>Start the diagnosis again. Follow the trouble diagnosis procedure when past error is detected.

6.CHECK UNIT REPRODUCTION

Perform the reproduction test as per the following procedure for each unit.

1. Turn the ignition switch OFF.
2. Disconnect the battery cable from the negative terminal.
3. Disconnect one of the unit connectors of CAN communication system.

NOTE:

ECM and IPDM E/R have a termination circuit. Check other units first.

4. Connect the battery cable to the negative terminal. Check if the symptoms described in the “Symptom (Results from interview with customer)” are reproduced.

NOTE:

Although unit-related error symptoms occur, do not confuse them with other symptoms.

Inspection result

Reproduced>>Connect the connector. Check other units as per the above procedure.

Non-reproduced>>Replace the unit whose connector was disconnected.

A
B
C
D
E
F
G
H
I
J
K
L

LAN

N
O
P

MAIN LINE BETWEEN ADP AND DLC CIRCUIT

< DTC/CIRCUIT DIAGNOSIS >

[CAN SYSTEM (TYPE 2)]

DTC/CIRCUIT DIAGNOSIS

MAIN LINE BETWEEN ADP AND DLC CIRCUIT

Diagnosis Procedure

INFOID:000000006234315

Regarding Wiring Diagram information, refer to [LAN-28, "Wiring Diagram"](#).

1. CHECK CONNECTOR

1. Turn the ignition switch OFF.
2. Disconnect the battery cable from the negative terminal.
3. Check the following terminals and connectors for damage, bend and loose connection (connector side and harness side).
 - Harness connector B1
 - Harness connector M6

Is the inspection result normal?

- YES >> GO TO 2.
NO >> Repair the terminal and connector.

2. CHECK HARNESS CONTINUITY (OPEN CIRCUIT)

1. Disconnect the following harness connectors.
 - Harness connectors B208 and B32
 - Harness connectors B1 and M6
2. Check the continuity between the harness connectors.

Harness connector		Harness connector		Continuity
Connector No.	Terminal No.	Connector No.	Terminal No.	
B32	9	B1	15J	Existed
	10		16J	Existed

Is the inspection result normal?

- YES >> GO TO 3.
NO >> Repair the main line between the harness connectors B32 and B1.

3. CHECK HARNESS CONTINUITY (OPEN CIRCUIT)

Check the continuity between the harness connector and the data link connector.

Harness connector		Data link connector		Continuity
Connector No.	Terminal No.	Connector No.	Terminal No.	
M6	15J	M22	6	Existed
	16J		14	Existed

Is the inspection result normal?

- YES (Present error)>>Check CAN system type decision again.
YES (Past error)>>Error was detected in the main line between the driver seat control unit and the data link connector.
NO >> Repair the main line between the harness connector M6 and the data link connector.

MAIN LINE BETWEEN DLC AND HVAC CIRCUIT

< DTC/CIRCUIT DIAGNOSIS >

[CAN SYSTEM (TYPE 2)]

MAIN LINE BETWEEN DLC AND HVAC CIRCUIT

Diagnosis Procedure

INFOID:000000006234316

Regarding Wiring Diagram information, refer to [LAN-28. "Wiring Diagram"](#).

1. CHECK HARNESS CONTINUITY (OPEN CIRCUIT)

1. Turn the ignition switch OFF.
2. Disconnect the battery cable from the negative terminal.
3. Disconnect the following harness connectors.
 - ECM
 - A/C auto amp.
4. Check the continuity between the data link connector and the A/C auto amp. harness connector.

Data link connector		A/C auto amp. harness connector		Continuity
Connector No.	Terminal No.	Connector No.	Terminal No.	
M22	6	M37	1	Existed
	14		2	Existed

Is the inspection result normal?

YES (Present error)>>Check CAN system type decision again.

YES (Past error)>>Error was detected in the main line between the data link connector and the A/C auto amp.

NO >> Repair the main line between the data link connector and the A/C auto amp.

LAN

MAIN LINE BETWEEN HVAC AND A-BAG CIRCUIT

< DTC/CIRCUIT DIAGNOSIS >

[CAN SYSTEM (TYPE 2)]

MAIN LINE BETWEEN HVAC AND A-BAG CIRCUIT

Diagnosis Procedure

INFOID:000000006234317

Regarding Wiring Diagram information, refer to [LAN-28. "Wiring Diagram"](#).

1. CHECK HARNESS CONTINUITY (OPEN CIRCUIT)

1. Turn the ignition switch OFF.
2. Disconnect the battery cable from the negative terminal.
3. Disconnect the following harness connectors.
 - A/C auto amp.
 - Harness connectors M1 and E30
4. Check the continuity between the harness connector and the A/C auto amp. harness connector.

A/C auto amp. harness connector		Harness connector		Continuity
Connector No.	Terminal No.	Connector No.	Terminal No.	
M37	1	M1	15G	Existed
	2		8G	Existed

Is the inspection result normal?

YES (Present error)>>Check CAN system type decision again.

YES (Past error)>>Error was detected in the main line between the A/C auto amp. and the air bag diagnosis sensor unit.

NO >> Repair the main line between the A/C auto amp. and the air bag diagnosis sensor unit.

MAIN LINE BETWEEN A-BAG AND ABS CIRCUIT

< DTC/CIRCUIT DIAGNOSIS >

[CAN SYSTEM (TYPE 2)]

MAIN LINE BETWEEN A-BAG AND ABS CIRCUIT

Diagnosis Procedure

INFOID:000000006234318

Regarding Wiring Diagram information, refer to [LAN-28. "Wiring Diagram"](#).

1. CHECK CONNECTOR

1. Turn the ignition switch OFF.
2. Disconnect the battery cable from the negative terminal.
3. Check the following terminals and connectors for damage, bend and loose connection (connector side and harness side).
 - Harness connector M1
 - Harness connector E30

Is the inspection result normal?

YES >> GO TO 2.

NO >> Repair the terminal and connector.

2. CHECK HARNESS CONTINUITY (OPEN CIRCUIT)

1. Disconnect the following harness connectors.
 - A/C auto amp.
 - Harness connectors M1 and E30
2. Check the continuity between the A/C auto amp. harness connector and the harness connector.

A/C auto amp. harness connector		Harness connector		Continuity
Connector No.	Terminal No.	Connector No.	Terminal No.	
M37	1	M1	15G	Existed
	2		8G	Existed

Is the inspection result normal?

YES >> GO TO 3.

NO >> Repair the main line between the air bag diagnosis sensor unit and the harness connector M1.

3. CHECK HARNESS CONTINUITY (OPEN CIRCUIT)

1. Disconnect the connector of ABS actuator and electric unit (control unit).
2. Check the continuity between the harness connector and the ABS actuator and electric unit (control unit) harness connector.

Harness connector		ABS actuator and electric unit (control unit) harness connector		Continuity
Connector No.	Terminal No.	Connector No.	Terminal No.	
E30	15G	E26	26	Existed
	8G		15	Existed

Is the inspection result normal?

YES (Present error)>>Check CAN system type decision again.

YES (Past error)>>Error was detected in the main line between the air bag diagnosis sensor unit and the ABS actuator and electric unit (control unit).

NO >> Repair the main line between the harness connector E30 and the ABS actuator and electric unit (control unit).

ECM BRANCH LINE CIRCUIT

Diagnosis Procedure

INFOID:000000006234319

Regarding Wiring Diagram information, refer to [LAN-28, "Wiring Diagram"](#).

1. CHECK CONNECTOR

1. Turn the ignition switch OFF.
2. Disconnect the battery cable from the negative terminal.
3. Check the following terminals and connectors for damage, bend and loose connection (unit side and connector side).
 - Models without automatic drive positioner
 - ECM
 - Harness connector E30
 - Harness connector M1
 - Models with automatic drive positioner
 - ECM
 - Harness connector E29
 - Harness connector B10

Is the inspection result normal?

- YES >> GO TO 2.
 NO >> Repair the terminal and connector.

2. CHECK HARNESS FOR OPEN CIRCUIT

1. Disconnect the connector of ECM.
2. Check the resistance between the ECM harness connector terminals.

ECM harness connector			Resistance (Ω)
Connector No.	Terminal No.		
E10	98	97	Approx. 108 – 132

Is the measurement value within the specification?

- YES >> GO TO 3.
 NO >> Repair the ECM branch line.

3. CHECK POWER SUPPLY AND GROUND CIRCUIT

Check the power supply and the ground circuit of the ECM. Refer to [EC-154, "Diagnosis Procedure"](#).

Is the inspection result normal?

- YES (Present error)>>Replace the ECM. Refer to [EC-17, "ADDITIONAL SERVICE WHEN REPLACING CONTROL UNIT : Description"](#).
 YES (Past error)>>Error was detected in the ECM branch line.
 NO >> Repair the power supply and the ground circuit.

ADP BRANCH LINE CIRCUIT

< DTC/CIRCUIT DIAGNOSIS >

[CAN SYSTEM (TYPE 2)]

ADP BRANCH LINE CIRCUIT

Diagnosis Procedure

INFOID:00000006234320

Regarding Wiring Diagram information, refer to [LAN-28. "Wiring Diagram"](#).

1. CHECK CONNECTOR

1. Turn the ignition switch OFF.
2. Disconnect the battery cable from the negative terminal.
3. Check the following terminals and connectors for damage, bend and loose connection (unit side and connector side).
 - Driver seat control unit
 - Harness connector B208
 - Harness connector B32

Is the inspection result normal?

- YES >> GO TO 2.
NO >> Repair the terminal and connector.

2. CHECK HARNESS FOR OPEN CIRCUIT

1. Disconnect the connector of driver seat control unit.
2. Check the resistance between the driver seat control unit harness connector terminals.

Driver seat control unit harness connector			Resistance (Ω)
Connector No.	Terminal No.		
B203	16	32	Approx. 54 – 66

Is the measurement value within the specification?

- YES >> GO TO 3.
NO >> Repair the driver seat control unit branch line.

3. CHECK POWER SUPPLY AND GROUND CIRCUIT

Check the power supply and the ground circuit of the driver seat control unit. Refer to [ADP-48. "DRIVER SEAT CONTROL UNIT : Diagnosis Procedure"](#).

Is the inspection result normal?

- YES (Present error)>>Replace the driver seat control unit. Refer to [ADP-171. "Removal and Installation"](#).
YES (Past error)>>Error was detected in the driver seat control unit branch line.
NO >> Repair the power supply and the ground circuit.

LAN

BCM BRANCH LINE CIRCUIT

Diagnosis Procedure

INFOID:000000006234321

Regarding Wiring Diagram information, refer to [LAN-28, "Wiring Diagram"](#).

1. CHECK CONNECTOR

1. Turn the ignition switch OFF.
2. Disconnect the battery cable from the negative terminal.
3. Check the terminals and connectors of the BCM for damage, bend and loose connection (unit side and connector side).

Is the inspection result normal?

- YES >> GO TO 2.
 NO >> Repair the terminal and connector.

2. CHECK HARNESS FOR OPEN CIRCUIT

1. Disconnect the connector of BCM.
2. Check the resistance between the BCM harness connector terminals.

BCM harness connector			Resistance (Ω)
Connector No.	Terminal No.		
M19	79	78	Approx. 54 – 66

Is the measurement value within the specification?

- YES >> GO TO 3.
 NO >> Repair the BCM branch line.

3. CHECK POWER SUPPLY AND GROUND CIRCUIT

Check the power supply and the ground circuit of the BCM. Refer to [BCS-36, "Diagnosis Procedure"](#).

Is the inspection result normal?

- YES (Present error)>>Replace the BCM. Refer to [BCS-80, "Removal and Installation"](#).
 YES (Past error)>>Error was detected in the BCM branch line.
 NO >> Repair the power supply and the ground circuit.

DLC BRANCH LINE CIRCUIT

< DTC/CIRCUIT DIAGNOSIS >

[CAN SYSTEM (TYPE 2)]

DLC BRANCH LINE CIRCUIT

Diagnosis Procedure

INFOID:00000006234322

Regarding Wiring Diagram information, refer to [LAN-28. "Wiring Diagram"](#).

1. CHECK CONNECTOR

1. Turn the ignition switch OFF.
2. Disconnect the battery cable from the negative terminal.
3. Check the terminals and connectors of the data link connector for damage, bend and loose connection (connector side and harness side).

Is the inspection result normal?

YES >> GO TO 2.

NO >> Repair the terminal and connector.

2. CHECK HARNESS FOR OPEN CIRCUIT

Check the resistance between the data link connector terminals.

Data link connector			Resistance (Ω)
Connector No.	Terminal No.		
M22	6	14	Approx. 54 – 66

Is the measurement value within the specification?

YES (Present error)>>Check CAN system type decision again.

YES (Past error)>>Error was detected in the data link connector branch line circuit.

NO >> Repair the data link connector branch line.

A
B
C
D
E
F
G
H
I
J
K
L

LAN

N
O
P

M&A BRANCH LINE CIRCUIT

Diagnosis Procedure

INFOID:000000006234323

Regarding Wiring Diagram information, refer to [LAN-28. "Wiring Diagram"](#).

1. CHECK CONNECTOR

1. Turn the ignition switch OFF.
2. Disconnect the battery cable from the negative terminal.
3. Check the terminals and connectors of the combination meter for damage, bend and loose connection (unit side and connector side).

Is the inspection result normal?

- YES >> GO TO 2.
 NO >> Repair the terminal and connector.

2. CHECK HARNESS FOR OPEN CIRCUIT

1. Disconnect the connector of combination meter.
2. Check the resistance between the combination meter harness connector terminals.

Combination meter harness connector			Resistance (Ω)
Connector No.	Terminal No.		
M24	21	22	Approx. 54 – 66

Is the measurement value within the specification?

- YES >> GO TO 3.
 NO >> Repair the combination meter branch line.

3. CHECK POWER SUPPLY AND GROUND CIRCUIT

Check the power supply and the ground circuit of the combination meter. Refer to [MWI-37. "COMBINATION METER : Diagnosis Procedure"](#).

Is the inspection result normal?

- YES (Present error)>>Replace the combination meter. Refer to [MWI-119. "Removal and Installation"](#).
 YES (Past error)>>Error was detected in the combination meter branch line.
 NO >> Repair the power supply and the ground circuit.

HVAC BRANCH LINE CIRCUIT

Diagnosis Procedure

INFOID:000000006234324

Regarding Wiring Diagram information, refer to [LAN-28, "Wiring Diagram"](#).

1. CHECK CONNECTOR

1. Turn the ignition switch OFF.
2. Disconnect the battery cable from the negative terminal.
3. Check the terminals and connectors of the A/C auto amp. for damage, bend and loose connection (unit side and connector side).

Is the inspection result normal?

- YES >> GO TO 2.
 NO >> Repair the terminal and connector.

2. CHECK HARNESS FOR OPEN CIRCUIT

1. Disconnect the connector of A/C auto amp.
2. Check the resistance between the A/C auto amp. harness connector terminals.

A/C auto amp. harness connector			Resistance (Ω)
Connector No.	Terminal No.		
M37	1	2	Approx. 54 – 66

Is the measurement value within the specification?

- YES >> GO TO 3.
 NO >> Repair the A/C auto amp. branch line.

3. CHECK POWER SUPPLY AND GROUND CIRCUIT

Check the power supply and the ground circuit of the A/C auto amp. Refer to the following.

- Models with color display: [HAC-60, "A/C AUTO AMP. : Diagnosis Procedure"](#)
- Models with monochrome display: [HAC-168, "A/C AUTO AMP. : Diagnosis Procedure"](#)

Is the inspection result normal?

- YES (Present error)>>Replace the A/C auto amp. Refer to the following.
- Models with color display: [HAC-104, "Removal and Installation"](#)
 - Models monochrome display: [HAC-212, "Removal and Installation"](#)
- YES (Past error)>>Error was detected in the A/C auto amp. branch line.
 NO >> Repair the power supply and the ground circuit.

A
B
C
D
E
F
G
H
I
J
K
L

LAN

STRG BRANCH LINE CIRCUIT

< DTC/CIRCUIT DIAGNOSIS >

[CAN SYSTEM (TYPE 2)]

STRG BRANCH LINE CIRCUIT

Diagnosis Procedure

INFOID:000000006234325

Regarding Wiring Diagram information, refer to [LAN-28. "Wiring Diagram"](#).

1. CHECK CONNECTOR

1. Turn the ignition switch OFF.
2. Disconnect the battery cable from the negative terminal.
3. Check the terminals and connectors of the steering angle sensor for damage, bend and loose connection (unit side and connector side).

Is the inspection result normal?

- YES >> GO TO 2.
NO >> Repair the terminal and connector.

2. CHECK HARNESS FOR OPEN CIRCUIT

1. Disconnect the connector of steering angle sensor.
2. Check the resistance between the steering angle sensor harness connector terminals.

Steering angle sensor harness connector			Resistance (Ω)
Connector No.	Terminal No.		
M53	5	2	Approx. 54 – 66

Is the measurement value within the specification?

- YES >> GO TO 3.
NO >> Repair the steering angle sensor branch line.

3. CHECK POWER SUPPLY AND GROUND CIRCUIT

Check the power supply and the ground circuit of the steering angle sensor. Refer to [BRC-86. "Wiring Diagram"](#).

Is the inspection result normal?

- YES (Present error)>>Replace the steering angle sensor. Refer to [BRC-110. "Removal and Installation"](#).
YES (Past error)>>Error was detected in the steering angle sensor branch line.
NO >> Repair the power supply and the ground circuit.

A-BAG BRANCH LINE CIRCUIT

< DTC/CIRCUIT DIAGNOSIS >

[CAN SYSTEM (TYPE 2)]

A-BAG BRANCH LINE CIRCUIT

Diagnosis Procedure

INFOID:000000006234326

WARNING:

- Before servicing, turn ignition switch OFF, disconnect battery negative terminal, and wait 3 minutes or more. (To discharge backup capacitor.)
- Never use unspecified tester or other measuring device.

1. CHECK CONNECTOR

Check the terminals and connectors of the air bag diagnosis sensor unit for damage, bend and loose connection (unit side and connector side).

Is the inspection result normal?

YES >> GO TO 2.

NO >> Replace the terminal and connector.

2. CHECK AIR BAG DIAGNOSIS SENSOR UNIT

Check the air bag diagnosis sensor unit. Refer to [SRC-3, "Work Flow"](#).

Is the inspection result normal?

YES >> Replace the main harness.

NO >> Replace parts whose air bag system has a malfunction.

A
B
C
D
E
F
G
H
I
J
K
L

LAN

N
O
P

ABS BRANCH LINE CIRCUIT

< DTC/CIRCUIT DIAGNOSIS >

[CAN SYSTEM (TYPE 2)]

ABS BRANCH LINE CIRCUIT

Diagnosis Procedure

INFOID:000000006234327

Regarding Wiring Diagram information, refer to [LAN-28, "Wiring Diagram"](#).

1. CHECK CONNECTOR

1. Turn the ignition switch OFF.
2. Disconnect the battery cable from the negative terminal.
3. Check the terminals and connectors of the ABS actuator and electric unit (control unit) for damage, bend and loose connection (unit side and connector side).

Is the inspection result normal?

- YES >> GO TO 2.
NO >> Repair the terminal and connector.

2. CHECK HARNESS FOR OPEN CIRCUIT

1. Disconnect the connector of ABS actuator and electric unit (control unit).
2. Check the resistance between the ABS actuator and electric unit (control unit) harness connector terminals.

ABS actuator and electric unit (control unit) harness connector			Resistance (Ω)
Connector No.	Terminal No.		
E26	26	15	Approx. 54 – 66

Is the measurement value within the specification?

- YES >> GO TO 3.
NO >> Repair the ABS actuator and electric unit (control unit) branch line.

3. CHECK POWER SUPPLY AND GROUND CIRCUIT

Check the power supply and the ground circuit of the ABS actuator and electric unit (control unit). Refer to [BRC-86, "Wiring Diagram"](#).

Is the inspection result normal?

- YES (Present error)>>Replace the ABS actuator and electric unit (control unit). Refer to [BRC-107, "Exploded View"](#).
YES (Past error)>>Error was detected in the ABS actuator and electric unit (control unit) branch line.
NO >> Repair the power supply and the ground circuit.

TCM BRANCH LINE CIRCUIT

< DTC/CIRCUIT DIAGNOSIS >

[CAN SYSTEM (TYPE 2)]

TCM BRANCH LINE CIRCUIT

Diagnosis Procedure

INFOID:000000006234328

Regarding Wiring Diagram information, refer to [LAN-28. "Wiring Diagram"](#).

1. CHECK CONNECTOR

1. Turn the ignition switch OFF.
2. Disconnect the battery cable from the negative terminal.
3. Check the following terminals and connectors for damage, bend and loose connection (unit side and connector side).
 - TCM
 - Harness connector F1
 - Harness connector E3

Is the inspection result normal?

- YES >> GO TO 2.
NO >> Repair the terminal and connector.

2. CHECK HARNESS FOR OPEN CIRCUIT

1. Disconnect the connector of TCM.
2. Check the resistance between the TCM harness connector terminals.

TCM harness connector			Resistance (Ω)
Connector No.	Terminal No.		
F15	32	31	Approx. 54 – 66

Is the measurement value within the specification?

- YES >> GO TO 3.
NO >> Repair the TCM branch line.

3. CHECK POWER SUPPLY AND GROUND CIRCUIT

Check the power supply and the ground circuit of the TCM. Refer to [TM-119. "Wiring Diagram"](#).

Is the inspection result normal?

- YES (Present error)>>Replace the TCM. Refer to [TM-161. "Exploded View"](#).
YES (Past error)>>Error was detected in the TCM branch line.
NO >> Repair the power supply and the ground circuit.

LAN

IPDM-E BRANCH LINE CIRCUIT

Diagnosis Procedure

INFOID:000000006234329

Regarding Wiring Diagram information, refer to [LAN-28. "Wiring Diagram"](#).

1. CHECK CONNECTOR

1. Turn the ignition switch OFF.
2. Disconnect the battery cable from the negative terminal.
3. Check the terminals and connectors of the IPDM E/R for damage, bend and loose connection (unit side and connector side).

Is the inspection result normal?

- YES >> GO TO 2.
 NO >> Repair the terminal and connector.

2. CHECK HARNESS FOR OPEN CIRCUIT

1. Disconnect the connector of IPDM E/R.
2. Check the resistance between the IPDM E/R harness connector terminals.

IPDM E/R harness connector			Resistance (Ω)
Connector No.	Terminal No.		
E17	40	39	Approx. 108 – 132

Is the measurement value within the specification?

- YES >> GO TO 3.
 NO >> Repair the IPDM E/R branch line.

3. CHECK POWER SUPPLY AND GROUND CIRCUIT

Check the power supply and the ground circuit of the IPDM E/R. Refer to [PCS-18. "Diagnosis Procedure"](#).

Is the inspection result normal?

- YES (Present error)>>Replace the IPDM E/R. Refer to [PCS-35. "Removal and Installation"](#).
 YES (Past error)>>Error was detected in the IPDM E/R branch line.
 NO >> Repair the power supply and the ground circuit.

CAN COMMUNICATION CIRCUIT

< DTC/CIRCUIT DIAGNOSIS >

[CAN SYSTEM (TYPE 2)]

CAN COMMUNICATION CIRCUIT

Diagnosis Procedure

INFOID:000000006234330

Regarding Wiring Diagram information, refer to [LAN-28. "Wiring Diagram"](#).

1. CONNECTOR INSPECTION

1. Turn the ignition switch OFF.
2. Disconnect the battery cable from the negative terminal.
3. Disconnect all the unit connectors on CAN communication system.
4. Check terminals and connectors for damage, bend and loose connection.

Is the inspection result normal?

YES >> GO TO 2.

NO >> Repair the terminal and connector.

2. CHECK HARNESS CONTINUITY (SHORT CIRCUIT)

Check the continuity between the data link connector terminals.

Data link connector		Continuity
Connector No.	Terminal No.	
M22	6	Not existed
	14	

Is the inspection result normal?

YES >> GO TO 3.

NO >> Check the harness and repair the root cause.

3. CHECK HARNESS CONTINUITY (SHORT CIRCUIT)

Check the continuity between the data link connector and the ground.

Data link connector		Ground	Continuity
Connector No.	Terminal No.		
M22	6		Not existed
	14		Not existed

Is the inspection result normal?

YES >> GO TO 4.

NO >> Check the harness and repair the root cause.

4. CHECK ECM AND IPDM E/R TERMINATION CIRCUIT

1. Remove the ECM and the IPDM E/R.
2. Check the resistance between the ECM terminals.

ECM		Resistance (Ω)
Terminal No.		
98	97	Approx. 108 – 132

3. Check the resistance between the IPDM E/R terminals.

IPDM E/R		Resistance (Ω)
Terminal No.		
40	39	Approx. 108 – 132

Is the measurement value within the specification?

YES >> GO TO 5.

NO >> Replace the ECM and/or the IPDM E/R.

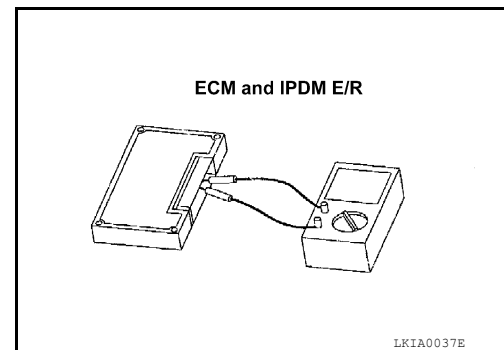

A
B
C
D
E
F
G
H
I
J
K
L
N
O
P

LAN

CAN COMMUNICATION CIRCUIT

< DTC/CIRCUIT DIAGNOSIS >

[CAN SYSTEM (TYPE 2)]

5.CHECK SYMPTOM

Connect all the connectors. Check if the symptoms described in the “Symptom (Results from interview with customer)” are reproduced.

Inspection result

Reproduced>>GO TO 6.

Non-reproduced>>Start the diagnosis again. Follow the trouble diagnosis procedure when past error is detected.

6.CHECK UNIT REPRODUCTION

Perform the reproduction test as per the following procedure for each unit.

1. Turn the ignition switch OFF.
2. Disconnect the battery cable from the negative terminal.
3. Disconnect one of the unit connectors of CAN communication system.

NOTE:

ECM and IPDM E/R have a termination circuit. Check other units first.

4. Connect the battery cable to the negative terminal. Check if the symptoms described in the “Symptom (Results from interview with customer)” are reproduced.

NOTE:

Although unit-related error symptoms occur, do not confuse them with other symptoms.

Inspection result

Reproduced>>Connect the connector. Check other units as per the above procedure.

Non-reproduced>>Replace the unit whose connector was disconnected.

MAIN LINE BETWEEN DLC AND HVAC CIRCUIT

< DTC/CIRCUIT DIAGNOSIS >

[CAN SYSTEM (TYPE 3)]

DTC/CIRCUIT DIAGNOSIS

MAIN LINE BETWEEN DLC AND HVAC CIRCUIT

Diagnosis Procedure

INFOID:000000006234331

Regarding Wiring Diagram information, refer to [LAN-28. "Wiring Diagram"](#).

1. CHECK HARNESS CONTINUITY (OPEN CIRCUIT)

1. Turn the ignition switch OFF.
2. Disconnect the battery cable from the negative terminal.
3. Disconnect the following harness connectors.
 - ECM
 - A/C auto amp.
4. Check the continuity between the data link connector and the A/C auto amp. harness connector.

Data link connector		A/C auto amp. harness connector		Continuity
Connector No.	Terminal No.	Connector No.	Terminal No.	
M22	6	M37	1	Existed
	14		2	Existed

Is the inspection result normal?

YES (Present error)>>Check CAN system type decision again.

YES (Past error)>>Error was detected in the main line between the data link connector and the A/C auto amp.

NO >> Repair the main line between the data link connector and the A/C auto amp.

LAN

MAIN LINE BETWEEN HVAC AND A-BAG CIRCUIT

< DTC/CIRCUIT DIAGNOSIS >

[CAN SYSTEM (TYPE 3)]

MAIN LINE BETWEEN HVAC AND A-BAG CIRCUIT

Diagnosis Procedure

INFOID:000000006234332

Regarding Wiring Diagram information, refer to [LAN-28. "Wiring Diagram"](#).

1. CHECK HARNESS CONTINUITY (OPEN CIRCUIT)

1. Turn the ignition switch OFF.
2. Disconnect the battery cable from the negative terminal.
3. Disconnect the following harness connectors.
 - A/C auto amp.
 - Harness connectors M1 and E30
4. Check the continuity between the harness connector and the A/C auto amp. harness connector.

A/C auto amp. harness connector		Harness connector		Continuity
Connector No.	Terminal No.	Connector No.	Terminal No.	
M37	1	M1	15G	Existed
	2		8G	Existed

Is the inspection result normal?

YES (Present error)>>Check CAN system type decision again.

YES (Past error)>>Error was detected in the main line between the A/C auto amp. and the air bag diagnosis sensor unit.

NO >> Repair the main line between the A/C auto amp. and the air bag diagnosis sensor unit.

MAIN LINE BETWEEN A-BAG AND ABS CIRCUIT

< DTC/CIRCUIT DIAGNOSIS >

[CAN SYSTEM (TYPE 3)]

MAIN LINE BETWEEN A-BAG AND ABS CIRCUIT

Diagnosis Procedure

INFOID:000000006234333

Regarding Wiring Diagram information, refer to [LAN-28. "Wiring Diagram"](#).

1. CHECK CONNECTOR

1. Turn the ignition switch OFF.
2. Disconnect the battery cable from the negative terminal.
3. Check the following terminals and connectors for damage, bend and loose connection (connector side and harness side).
 - Harness connector M1
 - Harness connector E30

Is the inspection result normal?

YES >> GO TO 2.

NO >> Repair the terminal and connector.

2. CHECK HARNESS CONTINUITY (OPEN CIRCUIT)

1. Disconnect the following harness connectors.
 - A/C auto amp.
 - Harness connectors M1 and E30
2. Check the continuity between the A/C auto amp. harness connector and the harness connector.

A/C auto amp. harness connector		Harness connector		Continuity
Connector No.	Terminal No.	Connector No.	Terminal No.	
M37	1	M1	15G	Existed
	2		8G	Existed

Is the inspection result normal?

YES >> GO TO 3.

NO >> Repair the main line between the air bag diagnosis sensor unit and the harness connector M1.

3. CHECK HARNESS CONTINUITY (OPEN CIRCUIT)

1. Disconnect the connector of ABS actuator and electric unit (control unit).
2. Check the continuity between the harness connector and the ABS actuator and electric unit (control unit) harness connector.

Harness connector		ABS actuator and electric unit (control unit) harness connector		Continuity
Connector No.	Terminal No.	Connector No.	Terminal No.	
E30	15G	E26	26	Existed
	8G		15	Existed

Is the inspection result normal?

YES (Present error)>>Check CAN system type decision again.

YES (Past error)>>Error was detected in the main line between the air bag diagnosis sensor unit and the ABS actuator and electric unit (control unit).

NO >> Repair the main line between the harness connector E30 and the ABS actuator and electric unit (control unit).

ECM BRANCH LINE CIRCUIT

Diagnosis Procedure

INFOID:000000006234334

Regarding Wiring Diagram information, refer to [LAN-28, "Wiring Diagram"](#).

1. CHECK CONNECTOR

1. Turn the ignition switch OFF.
2. Disconnect the battery cable from the negative terminal.
3. Check the following terminals and connectors for damage, bend and loose connection (unit side and connector side).
 - Models without automatic drive positioner
 - ECM
 - Harness connector E30
 - Harness connector M1
 - Models with automatic drive positioner
 - ECM
 - Harness connector E29
 - Harness connector B10

Is the inspection result normal?

- YES >> GO TO 2.
 NO >> Repair the terminal and connector.

2. CHECK HARNESS FOR OPEN CIRCUIT

1. Disconnect the connector of ECM.
2. Check the resistance between the ECM harness connector terminals.

ECM harness connector		Resistance (Ω)
Connector No.	Terminal No.	
E10	98 97	Approx. 108 – 132

Is the measurement value within the specification?

- YES >> GO TO 3.
 NO >> Repair the ECM branch line.

3. CHECK POWER SUPPLY AND GROUND CIRCUIT

Check the power supply and the ground circuit of the ECM. Refer to [EC-154, "Diagnosis Procedure"](#).

Is the inspection result normal?

- YES (Present error)>>Replace the ECM. Refer to [EC-17, "ADDITIONAL SERVICE WHEN REPLACING CONTROL UNIT : Description"](#).
 YES (Past error)>>Error was detected in the ECM branch line.
 NO >> Repair the power supply and the ground circuit.

BCM BRANCH LINE CIRCUIT

Diagnosis Procedure

INFOID:000000006234335

Regarding Wiring Diagram information, refer to [LAN-28. "Wiring Diagram"](#).

1.CHECK CONNECTOR

1. Turn the ignition switch OFF.
2. Disconnect the battery cable from the negative terminal.
3. Check the terminals and connectors of the BCM for damage, bend and loose connection (unit side and connector side).

Is the inspection result normal?

- YES >> GO TO 2.
 NO >> Repair the terminal and connector.

2.CHECK HARNESS FOR OPEN CIRCUIT

1. Disconnect the connector of BCM.
2. Check the resistance between the BCM harness connector terminals.

BCM harness connector			Resistance (Ω)
Connector No.	Terminal No.		
M19	79	78	Approx. 54 – 66

Is the measurement value within the specification?

- YES >> GO TO 3.
 NO >> Repair the BCM branch line.

3.CHECK POWER SUPPLY AND GROUND CIRCUIT

Check the power supply and the ground circuit of the BCM. Refer to [BCS-36. "Diagnosis Procedure"](#).

Is the inspection result normal?

- YES (Present error)>>Replace the BCM. Refer to [BCS-80. "Removal and Installation"](#).
 YES (Past error)>>Error was detected in the BCM branch line.
 NO >> Repair the power supply and the ground circuit.

A
B
C
D
E
F
G
H
I
J
K
L

LAN

DLC BRANCH LINE CIRCUIT

Diagnosis Procedure

INFOID:000000006234336

Regarding Wiring Diagram information, refer to [LAN-28. "Wiring Diagram"](#).

1. CHECK CONNECTOR

1. Turn the ignition switch OFF.
2. Disconnect the battery cable from the negative terminal.
3. Check the terminals and connectors of the data link connector for damage, bend and loose connection (connector side and harness side).

Is the inspection result normal?

- YES >> GO TO 2.
 NO >> Repair the terminal and connector.

2. CHECK HARNESS FOR OPEN CIRCUIT

Check the resistance between the data link connector terminals.

Data link connector			Resistance (Ω)
Connector No.	Terminal No.		
M22	6	14	Approx. 54 – 66

Is the measurement value within the specification?

- YES (Present error)>>Check CAN system type decision again.
 YES (Past error)>>Error was detected in the data link connector branch line circuit.
 NO >> Repair the data link connector branch line.

M&A BRANCH LINE CIRCUIT

Diagnosis Procedure

INFOID:000000006234337

Regarding Wiring Diagram information, refer to [LAN-28. "Wiring Diagram"](#).

1. CHECK CONNECTOR

1. Turn the ignition switch OFF.
2. Disconnect the battery cable from the negative terminal.
3. Check the terminals and connectors of the combination meter for damage, bend and loose connection (unit side and connector side).

Is the inspection result normal?

- YES >> GO TO 2.
 NO >> Repair the terminal and connector.

2. CHECK HARNESS FOR OPEN CIRCUIT

1. Disconnect the connector of combination meter.
2. Check the resistance between the combination meter harness connector terminals.

Combination meter harness connector			Resistance (Ω)
Connector No.	Terminal No.		
M24	21	22	Approx. 54 – 66

Is the measurement value within the specification?

- YES >> GO TO 3.
 NO >> Repair the combination meter branch line.

3. CHECK POWER SUPPLY AND GROUND CIRCUIT

Check the power supply and the ground circuit of the combination meter. Refer to [MWI-37. "COMBINATION METER : Diagnosis Procedure"](#).

Is the inspection result normal?

- YES (Present error)>>Replace the combination meter. Refer to [MWI-119. "Removal and Installation"](#).
 YES (Past error)>>Error was detected in the combination meter branch line.
 NO >> Repair the power supply and the ground circuit.

A
B
C
D
E
F
G
H
I
J
K
L

LAN

AV BRANCH LINE CIRCUIT

Diagnosis Procedure

INFOID:000000006545117

Regarding Wiring Diagram information, refer to [LAN-28, "Wiring Diagram"](#).

1. CHECK CONNECTOR

1. Turn the ignition switch OFF.
2. Disconnect the battery cable from the negative terminal.
3. Check the terminals and connectors of the AV control unit for damage, bend and loose connection (unit side and connector side).

Is the inspection result normal?

- YES >> GO TO 2.
 NO >> Repair the terminal and connector.

2. CHECK HARNESS FOR OPEN CIRCUIT

1. Disconnect the connector of AV control unit.
 2. Check the resistance between the AV control unit harness connector terminals.
- Models without navigation system

AV control unit harness connector			Resistance (Ω)
Connector No.	Terminal No.		
M156	86	87	Approx. 54 – 66

- Models with navigation system

AV control unit harness connector			Resistance (Ω)
Connector No.	Terminal No.		
M163	62	46	Approx. 54 – 66

Is the measurement value within the specification?

- YES >> GO TO 3.
 NO >> Repair the AV control unit branch line.

3. CHECK POWER SUPPLY AND GROUND CIRCUIT

Check the power supply and the ground circuit of the AV control unit. Refer to the following.

- Models with BOSE audio with color display: [AV-231, "AV CONTROL UNIT : Diagnosis Procedure"](#)
- Models with BOSE audio with color display with navigation system: [AV-411, "AV CONTROL UNIT : Diagnosis Procedure"](#)

Is the inspection result normal?

- YES (Present error)>>Replace the AV control unit. Refer to the following.
- Models with BOSE audio with color display: [AV-321, "Removal and Installation"](#)
 - Models with BOSE audio with color display with navigation system: [AV-489, "Removal and Installation"](#)

YES (Past error)>>Error was detected in the AV control unit branch line.

NO >> Repair the power supply and the ground circuit.

HVAC BRANCH LINE CIRCUIT

Diagnosis Procedure

INFOID:000000006234339

Regarding Wiring Diagram information, refer to [LAN-28, "Wiring Diagram"](#).

1. CHECK CONNECTOR

1. Turn the ignition switch OFF.
2. Disconnect the battery cable from the negative terminal.
3. Check the terminals and connectors of the A/C auto amp. for damage, bend and loose connection (unit side and connector side).

Is the inspection result normal?

- YES >> GO TO 2.
 NO >> Repair the terminal and connector.

2. CHECK HARNESS FOR OPEN CIRCUIT

1. Disconnect the connector of A/C auto amp.
2. Check the resistance between the A/C auto amp. harness connector terminals.

A/C auto amp. harness connector			Resistance (Ω)
Connector No.	Terminal No.		
M37	1	2	Approx. 54 – 66

Is the measurement value within the specification?

- YES >> GO TO 3.
 NO >> Repair the A/C auto amp. branch line.

3. CHECK POWER SUPPLY AND GROUND CIRCUIT

Check the power supply and the ground circuit of the A/C auto amp. Refer to the following.

- Models with color display: [HAC-60, "A/C AUTO AMP. : Diagnosis Procedure"](#)
- Models with monochrome display: [HAC-168, "A/C AUTO AMP. : Diagnosis Procedure"](#)

Is the inspection result normal?

- YES (Present error)>>Replace the A/C auto amp. Refer to the following.
- Models with color display: [HAC-104, "Removal and Installation"](#)
 - Models monochrome display: [HAC-212, "Removal and Installation"](#)

YES (Past error)>>Error was detected in the A/C auto amp. branch line.

NO >> Repair the power supply and the ground circuit.

LAN

STRG BRANCH LINE CIRCUIT

< DTC/CIRCUIT DIAGNOSIS >

[CAN SYSTEM (TYPE 3)]

STRG BRANCH LINE CIRCUIT

Diagnosis Procedure

INFOID:000000006234340

Regarding Wiring Diagram information, refer to [LAN-28. "Wiring Diagram"](#).

1. CHECK CONNECTOR

1. Turn the ignition switch OFF.
2. Disconnect the battery cable from the negative terminal.
3. Check the terminals and connectors of the steering angle sensor for damage, bend and loose connection (unit side and connector side).

Is the inspection result normal?

- YES >> GO TO 2.
NO >> Repair the terminal and connector.

2. CHECK HARNESS FOR OPEN CIRCUIT

1. Disconnect the connector of steering angle sensor.
2. Check the resistance between the steering angle sensor harness connector terminals.

Steering angle sensor harness connector			Resistance (Ω)
Connector No.	Terminal No.		
M53	5	2	Approx. 54 – 66

Is the measurement value within the specification?

- YES >> GO TO 3.
NO >> Repair the steering angle sensor branch line.

3. CHECK POWER SUPPLY AND GROUND CIRCUIT

Check the power supply and the ground circuit of the steering angle sensor. Refer to [BRC-86. "Wiring Diagram"](#).

Is the inspection result normal?

- YES (Present error)>>Replace the steering angle sensor. Refer to [BRC-110. "Removal and Installation"](#).
YES (Past error)>>Error was detected in the steering angle sensor branch line.
NO >> Repair the power supply and the ground circuit.

A-BAG BRANCH LINE CIRCUIT

< DTC/CIRCUIT DIAGNOSIS >

[CAN SYSTEM (TYPE 3)]

A-BAG BRANCH LINE CIRCUIT

Diagnosis Procedure

INFOID:000000006234341

WARNING:

- Before servicing, turn ignition switch OFF, disconnect battery negative terminal, and wait 3 minutes or more. (To discharge backup capacitor.)
- Never use unspecified tester or other measuring device.

1. CHECK CONNECTOR

Check the terminals and connectors of the air bag diagnosis sensor unit for damage, bend and loose connection (unit side and connector side).

Is the inspection result normal?

YES >> GO TO 2.

NO >> Replace the terminal and connector.

2. CHECK AIR BAG DIAGNOSIS SENSOR UNIT

Check the air bag diagnosis sensor unit. Refer to [SRC-3, "Work Flow"](#).

Is the inspection result normal?

YES >> Replace the main harness.

NO >> Replace parts whose air bag system has a malfunction.

A
B
C
D
E
F
G
H
I
J
K
L
N
O
P

LAN

ABS BRANCH LINE CIRCUIT

Diagnosis Procedure

INFOID:000000006234342

Regarding Wiring Diagram information, refer to [LAN-28, "Wiring Diagram"](#).

1. CHECK CONNECTOR

1. Turn the ignition switch OFF.
2. Disconnect the battery cable from the negative terminal.
3. Check the terminals and connectors of the ABS actuator and electric unit (control unit) for damage, bend and loose connection (unit side and connector side).

Is the inspection result normal?

- YES >> GO TO 2.
 NO >> Repair the terminal and connector.

2. CHECK HARNESS FOR OPEN CIRCUIT

1. Disconnect the connector of ABS actuator and electric unit (control unit).
2. Check the resistance between the ABS actuator and electric unit (control unit) harness connector terminals.

ABS actuator and electric unit (control unit) harness connector			Resistance (Ω)
Connector No.	Terminal No.		
E26	26	15	Approx. 54 – 66

Is the measurement value within the specification?

- YES >> GO TO 3.
 NO >> Repair the ABS actuator and electric unit (control unit) branch line.

3. CHECK POWER SUPPLY AND GROUND CIRCUIT

Check the power supply and the ground circuit of the ABS actuator and electric unit (control unit). Refer to [BRC-86, "Wiring Diagram"](#).

Is the inspection result normal?

- YES (Present error)>>Replace the ABS actuator and electric unit (control unit). Refer to [BRC-107, "Exploded View"](#).
 YES (Past error)>>Error was detected in the ABS actuator and electric unit (control unit) branch line.
 NO >> Repair the power supply and the ground circuit.

TCM BRANCH LINE CIRCUIT

< DTC/CIRCUIT DIAGNOSIS >

[CAN SYSTEM (TYPE 3)]

TCM BRANCH LINE CIRCUIT

Diagnosis Procedure

INFOID:000000006234343

Regarding Wiring Diagram information, refer to [LAN-28. "Wiring Diagram"](#).

1. CHECK CONNECTOR

1. Turn the ignition switch OFF.
2. Disconnect the battery cable from the negative terminal.
3. Check the following terminals and connectors for damage, bend and loose connection (unit side and connector side).
 - TCM
 - Harness connector F1
 - Harness connector E3

Is the inspection result normal?

- YES >> GO TO 2.
NO >> Repair the terminal and connector.

2. CHECK HARNESS FOR OPEN CIRCUIT

1. Disconnect the connector of TCM.
2. Check the resistance between the TCM harness connector terminals.

TCM harness connector			Resistance (Ω)
Connector No.	Terminal No.		
F15	32	31	Approx. 54 – 66

Is the measurement value within the specification?

- YES >> GO TO 3.
NO >> Repair the TCM branch line.

3. CHECK POWER SUPPLY AND GROUND CIRCUIT

Check the power supply and the ground circuit of the TCM. Refer to [TM-119. "Wiring Diagram"](#).

Is the inspection result normal?

- YES (Present error)>>Replace the TCM. Refer to [TM-161. "Exploded View"](#).
YES (Past error)>>Error was detected in the TCM branch line.
NO >> Repair the power supply and the ground circuit.

LAN

IPDM-E BRANCH LINE CIRCUIT

Diagnosis Procedure

INFOID:000000006234344

Regarding Wiring Diagram information, refer to [LAN-28. "Wiring Diagram"](#).

1. CHECK CONNECTOR

1. Turn the ignition switch OFF.
2. Disconnect the battery cable from the negative terminal.
3. Check the terminals and connectors of the IPDM E/R for damage, bend and loose connection (unit side and connector side).

Is the inspection result normal?

- YES >> GO TO 2.
 NO >> Repair the terminal and connector.

2. CHECK HARNESS FOR OPEN CIRCUIT

1. Disconnect the connector of IPDM E/R.
2. Check the resistance between the IPDM E/R harness connector terminals.

IPDM E/R harness connector			Resistance (Ω)
Connector No.	Terminal No.		
E17	40	39	Approx. 108 – 132

Is the measurement value within the specification?

- YES >> GO TO 3.
 NO >> Repair the IPDM E/R branch line.

3. CHECK POWER SUPPLY AND GROUND CIRCUIT

Check the power supply and the ground circuit of the IPDM E/R. Refer to [PCS-18. "Diagnosis Procedure"](#).

Is the inspection result normal?

- YES (Present error)>>Replace the IPDM E/R. Refer to [PCS-35. "Removal and Installation"](#).
 YES (Past error)>>Error was detected in the IPDM E/R branch line.
 NO >> Repair the power supply and the ground circuit.

CAN COMMUNICATION CIRCUIT

< DTC/CIRCUIT DIAGNOSIS >

[CAN SYSTEM (TYPE 3)]

CAN COMMUNICATION CIRCUIT

Diagnosis Procedure

INFOID:000000006234345

Regarding Wiring Diagram information, refer to [LAN-28. "Wiring Diagram"](#).

1. CONNECTOR INSPECTION

1. Turn the ignition switch OFF.
2. Disconnect the battery cable from the negative terminal.
3. Disconnect all the unit connectors on CAN communication system.
4. Check terminals and connectors for damage, bend and loose connection.

Is the inspection result normal?

YES >> GO TO 2.

NO >> Repair the terminal and connector.

2. CHECK HARNESS CONTINUITY (SHORT CIRCUIT)

Check the continuity between the data link connector terminals.

Data link connector		Continuity
Connector No.	Terminal No.	
M22	6	Not existed
	14	

Is the inspection result normal?

YES >> GO TO 3.

NO >> Check the harness and repair the root cause.

3. CHECK HARNESS CONTINUITY (SHORT CIRCUIT)

Check the continuity between the data link connector and the ground.

Data link connector		Ground	Continuity
Connector No.	Terminal No.		
M22	6		Not existed
	14		Not existed

Is the inspection result normal?

YES >> GO TO 4.

NO >> Check the harness and repair the root cause.

4. CHECK ECM AND IPDM E/R TERMINATION CIRCUIT

1. Remove the ECM and the IPDM E/R.
2. Check the resistance between the ECM terminals.

ECM		Resistance (Ω)
Terminal No.		
98	97	Approx. 108 – 132

3. Check the resistance between the IPDM E/R terminals.

IPDM E/R		Resistance (Ω)
Terminal No.		
40	39	Approx. 108 – 132

Is the measurement value within the specification?

YES >> GO TO 5.

NO >> Replace the ECM and/or the IPDM E/R.

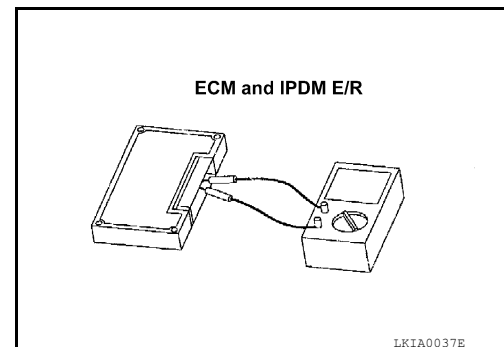

A
B
C
D
E
F
G
H
I
J
K
L
N
O
P

LAN

CAN COMMUNICATION CIRCUIT

< DTC/CIRCUIT DIAGNOSIS >

[CAN SYSTEM (TYPE 3)]

5. CHECK SYMPTOM

Connect all the connectors. Check if the symptoms described in the “Symptom (Results from interview with customer)” are reproduced.

Inspection result

Reproduced>>GO TO 6.

Non-reproduced>>Start the diagnosis again. Follow the trouble diagnosis procedure when past error is detected.

6. CHECK UNIT REPRODUCTION

Perform the reproduction test as per the following procedure for each unit.

1. Turn the ignition switch OFF.
2. Disconnect the battery cable from the negative terminal.
3. Disconnect one of the unit connectors of CAN communication system.

NOTE:

ECM and IPDM E/R have a termination circuit. Check other units first.

4. Connect the battery cable to the negative terminal. Check if the symptoms described in the “Symptom (Results from interview with customer)” are reproduced.

NOTE:

Although unit-related error symptoms occur, do not confuse them with other symptoms.

Inspection result

Reproduced>>Connect the connector. Check other units as per the above procedure.

Non-reproduced>>Replace the unit whose connector was disconnected.

MAIN LINE BETWEEN ADP AND DLC CIRCUIT

< DTC/CIRCUIT DIAGNOSIS >

[CAN SYSTEM (TYPE 4)]

DTC/CIRCUIT DIAGNOSIS

MAIN LINE BETWEEN ADP AND DLC CIRCUIT

Diagnosis Procedure

INFOID:000000006234346

Regarding Wiring Diagram information, refer to [LAN-28. "Wiring Diagram"](#).

1. CHECK CONNECTOR

1. Turn the ignition switch OFF.
2. Disconnect the battery cable from the negative terminal.
3. Check the following terminals and connectors for damage, bend and loose connection (connector side and harness side).
 - Harness connector B1
 - Harness connector M6

Is the inspection result normal?

YES >> GO TO 2.

NO >> Repair the terminal and connector.

2. CHECK HARNESS CONTINUITY (OPEN CIRCUIT)

1. Disconnect the following harness connectors.
 - Harness connectors B208 and B32
 - Harness connectors B1 and M6
2. Check the continuity between the harness connectors.

Harness connector		Harness connector		Continuity
Connector No.	Terminal No.	Connector No.	Terminal No.	
B32	9	B1	15J	Existed
	10		16J	Existed

Is the inspection result normal?

YES >> GO TO 3.

NO >> Repair the main line between the harness connectors B32 and B1.

3. CHECK HARNESS CONTINUITY (OPEN CIRCUIT)

Check the continuity between the harness connector and the data link connector.

Harness connector		Data link connector		Continuity
Connector No.	Terminal No.	Connector No.	Terminal No.	
M6	15J	M22	6	Existed
	16J		14	Existed

Is the inspection result normal?

YES (Present error)>>Check CAN system type decision again.

YES (Past error)>>Error was detected in the main line between the driver seat control unit and the data link connector.

NO >> Repair the main line between the harness connector M6 and the data link connector.

MAIN LINE BETWEEN DLC AND HVAC CIRCUIT

< DTC/CIRCUIT DIAGNOSIS >

[CAN SYSTEM (TYPE 4)]

MAIN LINE BETWEEN DLC AND HVAC CIRCUIT

Diagnosis Procedure

INFOID:000000006234347

Regarding Wiring Diagram information, refer to [LAN-28. "Wiring Diagram"](#).

1. CHECK HARNESS CONTINUITY (OPEN CIRCUIT)

1. Turn the ignition switch OFF.
2. Disconnect the battery cable from the negative terminal.
3. Disconnect the following harness connectors.
 - ECM
 - A/C auto amp.
4. Check the continuity between the data link connector and the A/C auto amp. harness connector.

Data link connector		A/C auto amp. harness connector		Continuity
Connector No.	Terminal No.	Connector No.	Terminal No.	
M22	6	M37	1	Existed
	14		2	Existed

Is the inspection result normal?

YES (Present error)>>Check CAN system type decision again.

YES (Past error)>>Error was detected in the main line between the data link connector and the A/C auto amp.

NO >> Repair the main line between the data link connector and the A/C auto amp.

MAIN LINE BETWEEN HVAC AND A-BAG CIRCUIT

< DTC/CIRCUIT DIAGNOSIS >

[CAN SYSTEM (TYPE 4)]

MAIN LINE BETWEEN HVAC AND A-BAG CIRCUIT

Diagnosis Procedure

INFOID:000000006234348

Regarding Wiring Diagram information, refer to [LAN-28. "Wiring Diagram"](#).

1. CHECK HARNESS CONTINUITY (OPEN CIRCUIT)

1. Turn the ignition switch OFF.
2. Disconnect the battery cable from the negative terminal.
3. Disconnect the following harness connectors.
 - A/C auto amp.
 - Harness connectors M1 and E30
4. Check the continuity between the harness connector and the A/C auto amp. harness connector.

A/C auto amp. harness connector		Harness connector		Continuity
Connector No.	Terminal No.	Connector No.	Terminal No.	
M37	1	M1	15G	Existed
	2		8G	Existed

Is the inspection result normal?

YES (Present error)>>Check CAN system type decision again.

YES (Past error)>>Error was detected in the main line between the A/C auto amp. and the air bag diagnosis sensor unit.

NO >> Repair the main line between the A/C auto amp. and the air bag diagnosis sensor unit.

A
B
C
D
E
F
G
H
I
J
K
L
N
O
P

LAN

MAIN LINE BETWEEN A-BAG AND ABS CIRCUIT

< DTC/CIRCUIT DIAGNOSIS >

[CAN SYSTEM (TYPE 4)]

MAIN LINE BETWEEN A-BAG AND ABS CIRCUIT

Diagnosis Procedure

INFOID:000000006234349

Regarding Wiring Diagram information, refer to [LAN-28. "Wiring Diagram"](#).

1. CHECK CONNECTOR

1. Turn the ignition switch OFF.
2. Disconnect the battery cable from the negative terminal.
3. Check the following terminals and connectors for damage, bend and loose connection (connector side and harness side).
 - Harness connector M1
 - Harness connector E30

Is the inspection result normal?

- YES >> GO TO 2.
NO >> Repair the terminal and connector.

2. CHECK HARNESS CONTINUITY (OPEN CIRCUIT)

1. Disconnect the following harness connectors.
 - A/C auto amp.
 - Harness connectors M1 and E30
2. Check the continuity between the A/C auto amp. harness connector and the harness connector.

A/C auto amp. harness connector		Harness connector		Continuity
Connector No.	Terminal No.	Connector No.	Terminal No.	
M37	1	M1	15G	Existed
	2		8G	Existed

Is the inspection result normal?

- YES >> GO TO 3.
NO >> Repair the main line between the air bag diagnosis sensor unit and the harness connector M1.

3. CHECK HARNESS CONTINUITY (OPEN CIRCUIT)

1. Disconnect the connector of ABS actuator and electric unit (control unit).
2. Check the continuity between the harness connector and the ABS actuator and electric unit (control unit) harness connector.

Harness connector		ABS actuator and electric unit (control unit) harness connector		Continuity
Connector No.	Terminal No.	Connector No.	Terminal No.	
E30	15G	E26	26	Existed
	8G		15	Existed

Is the inspection result normal?

- YES (Present error)>>Check CAN system type decision again.
YES (Past error)>>Error was detected in the main line between the air bag diagnosis sensor unit and the ABS actuator and electric unit (control unit).
NO >> Repair the main line between the harness connector E30 and the ABS actuator and electric unit (control unit).

ECM BRANCH LINE CIRCUIT

Diagnosis Procedure

INFOID:000000006234350

Regarding Wiring Diagram information, refer to [LAN-28. "Wiring Diagram"](#).

1. CHECK CONNECTOR

1. Turn the ignition switch OFF.
2. Disconnect the battery cable from the negative terminal.
3. Check the following terminals and connectors for damage, bend and loose connection (unit side and connector side).
 - Models without automatic drive positioner
 - ECM
 - Harness connector E30
 - Harness connector M1
 - Models with automatic drive positioner
 - ECM
 - Harness connector E29
 - Harness connector B10

Is the inspection result normal?

- YES >> GO TO 2.
- NO >> Repair the terminal and connector.

2. CHECK HARNESS FOR OPEN CIRCUIT

1. Disconnect the connector of ECM.
2. Check the resistance between the ECM harness connector terminals.

ECM harness connector		Resistance (Ω)
Connector No.	Terminal No.	
E10	98 97	Approx. 108 – 132

Is the measurement value within the specification?

- YES >> GO TO 3.
- NO >> Repair the ECM branch line.

3. CHECK POWER SUPPLY AND GROUND CIRCUIT

Check the power supply and the ground circuit of the ECM. Refer to [EC-154. "Diagnosis Procedure"](#).

Is the inspection result normal?

- YES (Present error)>>Replace the ECM. Refer to [EC-17. "ADDITIONAL SERVICE WHEN REPLACING CONTROL UNIT : Description"](#).
- YES (Past error)>>Error was detected in the ECM branch line.
- NO >> Repair the power supply and the ground circuit.

LAN

ADP BRANCH LINE CIRCUIT

Diagnosis Procedure

INFOID:000000006234351

Regarding Wiring Diagram information, refer to [LAN-28. "Wiring Diagram"](#).

1. CHECK CONNECTOR

1. Turn the ignition switch OFF.
2. Disconnect the battery cable from the negative terminal.
3. Check the following terminals and connectors for damage, bend and loose connection (unit side and connector side).
 - Driver seat control unit
 - Harness connector B208
 - Harness connector B32

Is the inspection result normal?

- YES >> GO TO 2.
 NO >> Repair the terminal and connector.

2. CHECK HARNESS FOR OPEN CIRCUIT

1. Disconnect the connector of driver seat control unit.
2. Check the resistance between the driver seat control unit harness connector terminals.

Driver seat control unit harness connector			Resistance (Ω)
Connector No.	Terminal No.		
B203	16	32	Approx. 54 – 66

Is the measurement value within the specification?

- YES >> GO TO 3.
 NO >> Repair the driver seat control unit branch line.

3. CHECK POWER SUPPLY AND GROUND CIRCUIT

Check the power supply and the ground circuit of the driver seat control unit. Refer to [ADP-48. "DRIVER SEAT CONTROL UNIT : Diagnosis Procedure"](#).

Is the inspection result normal?

- YES (Present error)>>Replace the driver seat control unit. Refer to [ADP-171. "Removal and Installation"](#).
 YES (Past error)>>Error was detected in the driver seat control unit branch line.
 NO >> Repair the power supply and the ground circuit.

BCM BRANCH LINE CIRCUIT

Diagnosis Procedure

INFOID:000000006234352

Regarding Wiring Diagram information, refer to [LAN-28. "Wiring Diagram"](#).

1.CHECK CONNECTOR

1. Turn the ignition switch OFF.
2. Disconnect the battery cable from the negative terminal.
3. Check the terminals and connectors of the BCM for damage, bend and loose connection (unit side and connector side).

Is the inspection result normal?

- YES >> GO TO 2.
 NO >> Repair the terminal and connector.

2.CHECK HARNESS FOR OPEN CIRCUIT

1. Disconnect the connector of BCM.
2. Check the resistance between the BCM harness connector terminals.

BCM harness connector			Resistance (Ω)
Connector No.	Terminal No.		
M19	79	78	Approx. 54 – 66

Is the measurement value within the specification?

- YES >> GO TO 3.
 NO >> Repair the BCM branch line.

3.CHECK POWER SUPPLY AND GROUND CIRCUIT

Check the power supply and the ground circuit of the BCM. Refer to [BCS-36. "Diagnosis Procedure"](#).

Is the inspection result normal?

- YES (Present error)>>Replace the BCM. Refer to [BCS-80. "Removal and Installation"](#).
 YES (Past error)>>Error was detected in the BCM branch line.
 NO >> Repair the power supply and the ground circuit.

LAN

DLC BRANCH LINE CIRCUIT

Diagnosis Procedure

INFOID:000000006234353

Regarding Wiring Diagram information, refer to [LAN-28. "Wiring Diagram"](#).

1. CHECK CONNECTOR

1. Turn the ignition switch OFF.
2. Disconnect the battery cable from the negative terminal.
3. Check the terminals and connectors of the data link connector for damage, bend and loose connection (connector side and harness side).

Is the inspection result normal?

- YES >> GO TO 2.
 NO >> Repair the terminal and connector.

2. CHECK HARNESS FOR OPEN CIRCUIT

Check the resistance between the data link connector terminals.

Data link connector			Resistance (Ω)
Connector No.	Terminal No.		
M22	6	14	Approx. 54 – 66

Is the measurement value within the specification?

- YES (Present error)>>Check CAN system type decision again.
 YES (Past error)>>Error was detected in the data link connector branch line circuit.
 NO >> Repair the data link connector branch line.

M&A BRANCH LINE CIRCUIT

Diagnosis Procedure

INFOID:000000006234354

Regarding Wiring Diagram information, refer to [LAN-28. "Wiring Diagram"](#).

1. CHECK CONNECTOR

1. Turn the ignition switch OFF.
2. Disconnect the battery cable from the negative terminal.
3. Check the terminals and connectors of the combination meter for damage, bend and loose connection (unit side and connector side).

Is the inspection result normal?

- YES >> GO TO 2.
 NO >> Repair the terminal and connector.

2. CHECK HARNESS FOR OPEN CIRCUIT

1. Disconnect the connector of combination meter.
2. Check the resistance between the combination meter harness connector terminals.

Combination meter harness connector			Resistance (Ω)
Connector No.	Terminal No.		
M24	21	22	Approx. 54 – 66

Is the measurement value within the specification?

- YES >> GO TO 3.
 NO >> Repair the combination meter branch line.

3. CHECK POWER SUPPLY AND GROUND CIRCUIT

Check the power supply and the ground circuit of the combination meter. Refer to [MWI-37. "COMBINATION METER : Diagnosis Procedure"](#).

Is the inspection result normal?

- YES (Present error)>>Replace the combination meter. Refer to [MWI-119. "Removal and Installation"](#).
 YES (Past error)>>Error was detected in the combination meter branch line.
 NO >> Repair the power supply and the ground circuit.

LAN

AV BRANCH LINE CIRCUIT

Diagnosis Procedure

INFOID:000000006545132

Regarding Wiring Diagram information, refer to [LAN-28, "Wiring Diagram"](#).

1. CHECK CONNECTOR

1. Turn the ignition switch OFF.
2. Disconnect the battery cable from the negative terminal.
3. Check the terminals and connectors of the AV control unit for damage, bend and loose connection (unit side and connector side).

Is the inspection result normal?

- YES >> GO TO 2.
 NO >> Repair the terminal and connector.

2. CHECK HARNESS FOR OPEN CIRCUIT

1. Disconnect the connector of AV control unit.
 2. Check the resistance between the AV control unit harness connector terminals.
- Models without navigation system

AV control unit harness connector			Resistance (Ω)
Connector No.	Terminal No.		
M156	86	87	Approx. 54 – 66

- Models with navigation system

AV control unit harness connector			Resistance (Ω)
Connector No.	Terminal No.		
M163	62	46	Approx. 54 – 66

Is the measurement value within the specification?

- YES >> GO TO 3.
 NO >> Repair the AV control unit branch line.

3. CHECK POWER SUPPLY AND GROUND CIRCUIT

Check the power supply and the ground circuit of the AV control unit. Refer to the following.

- Models with BOSE audio with color display: [AV-231, "AV CONTROL UNIT : Diagnosis Procedure"](#)
- Models with BOSE audio with color display with navigation system: [AV-411, "AV CONTROL UNIT : Diagnosis Procedure"](#)

Is the inspection result normal?

- YES (Present error)>>Replace the AV control unit. Refer to the following.
- Models with BOSE audio with color display: [AV-321, "Removal and Installation"](#)
 - Models with BOSE audio with color display with navigation system: [AV-489, "Removal and Installation"](#)

YES (Past error)>>Error was detected in the AV control unit branch line.

NO >> Repair the power supply and the ground circuit.

HVAC BRANCH LINE CIRCUIT

Diagnosis Procedure

INFOID:000000006234356

Regarding Wiring Diagram information, refer to [LAN-28, "Wiring Diagram"](#).

1. CHECK CONNECTOR

1. Turn the ignition switch OFF.
2. Disconnect the battery cable from the negative terminal.
3. Check the terminals and connectors of the A/C auto amp. for damage, bend and loose connection (unit side and connector side).

Is the inspection result normal?

- YES >> GO TO 2.
 NO >> Repair the terminal and connector.

2. CHECK HARNESS FOR OPEN CIRCUIT

1. Disconnect the connector of A/C auto amp.
2. Check the resistance between the A/C auto amp. harness connector terminals.

A/C auto amp. harness connector			Resistance (Ω)
Connector No.	Terminal No.		
M37	1	2	Approx. 54 – 66

Is the measurement value within the specification?

- YES >> GO TO 3.
 NO >> Repair the A/C auto amp. branch line.

3. CHECK POWER SUPPLY AND GROUND CIRCUIT

Check the power supply and the ground circuit of the A/C auto amp. Refer to the following.

- Models with color display: [HAC-60, "A/C AUTO AMP. : Diagnosis Procedure"](#)
- Models with monochrome display: [HAC-168, "A/C AUTO AMP. : Diagnosis Procedure"](#)

Is the inspection result normal?

- YES (Present error)>>Replace the A/C auto amp. Refer to the following.
- Models with color display: [HAC-104, "Removal and Installation"](#)
 - Models monochrome display: [HAC-212, "Removal and Installation"](#)

YES (Past error)>>Error was detected in the A/C auto amp. branch line.

NO >> Repair the power supply and the ground circuit.

LAN

STRG BRANCH LINE CIRCUIT

< DTC/CIRCUIT DIAGNOSIS >

[CAN SYSTEM (TYPE 4)]

STRG BRANCH LINE CIRCUIT

Diagnosis Procedure

INFOID:000000006234357

Regarding Wiring Diagram information, refer to [LAN-28. "Wiring Diagram"](#).

1. CHECK CONNECTOR

1. Turn the ignition switch OFF.
2. Disconnect the battery cable from the negative terminal.
3. Check the terminals and connectors of the steering angle sensor for damage, bend and loose connection (unit side and connector side).

Is the inspection result normal?

- YES >> GO TO 2.
NO >> Repair the terminal and connector.

2. CHECK HARNESS FOR OPEN CIRCUIT

1. Disconnect the connector of steering angle sensor.
2. Check the resistance between the steering angle sensor harness connector terminals.

Steering angle sensor harness connector			Resistance (Ω)
Connector No.	Terminal No.		
M53	5	2	Approx. 54 – 66

Is the measurement value within the specification?

- YES >> GO TO 3.
NO >> Repair the steering angle sensor branch line.

3. CHECK POWER SUPPLY AND GROUND CIRCUIT

Check the power supply and the ground circuit of the steering angle sensor. Refer to [BRC-86. "Wiring Diagram"](#).

Is the inspection result normal?

- YES (Present error)>>Replace the steering angle sensor. Refer to [BRC-110. "Removal and Installation"](#).
YES (Past error)>>Error was detected in the steering angle sensor branch line.
NO >> Repair the power supply and the ground circuit.

A-BAG BRANCH LINE CIRCUIT

< DTC/CIRCUIT DIAGNOSIS >

[CAN SYSTEM (TYPE 4)]

A-BAG BRANCH LINE CIRCUIT

Diagnosis Procedure

INFOID:000000006234358

WARNING:

- Before servicing, turn ignition switch OFF, disconnect battery negative terminal, and wait 3 minutes or more. (To discharge backup capacitor.)
- Never use unspecified tester or other measuring device.

1. CHECK CONNECTOR

Check the terminals and connectors of the air bag diagnosis sensor unit for damage, bend and loose connection (unit side and connector side).

Is the inspection result normal?

YES >> GO TO 2.

NO >> Replace the terminal and connector.

2. CHECK AIR BAG DIAGNOSIS SENSOR UNIT

Check the air bag diagnosis sensor unit. Refer to [SRC-3, "Work Flow"](#).

Is the inspection result normal?

YES >> Replace the main harness.

NO >> Replace parts whose air bag system has a malfunction.

A
B
C
D
E
F
G
H
I
J
K
L

LAN

N
O
P

ABS BRANCH LINE CIRCUIT

< DTC/CIRCUIT DIAGNOSIS >

[CAN SYSTEM (TYPE 4)]

ABS BRANCH LINE CIRCUIT

Diagnosis Procedure

INFOID:000000006234359

Regarding Wiring Diagram information, refer to [LAN-28, "Wiring Diagram"](#).

1. CHECK CONNECTOR

1. Turn the ignition switch OFF.
2. Disconnect the battery cable from the negative terminal.
3. Check the terminals and connectors of the ABS actuator and electric unit (control unit) for damage, bend and loose connection (unit side and connector side).

Is the inspection result normal?

- YES >> GO TO 2.
NO >> Repair the terminal and connector.

2. CHECK HARNESS FOR OPEN CIRCUIT

1. Disconnect the connector of ABS actuator and electric unit (control unit).
2. Check the resistance between the ABS actuator and electric unit (control unit) harness connector terminals.

ABS actuator and electric unit (control unit) harness connector			Resistance (Ω)
Connector No.	Terminal No.		
E26	26	15	Approx. 54 – 66

Is the measurement value within the specification?

- YES >> GO TO 3.
NO >> Repair the ABS actuator and electric unit (control unit) branch line.

3. CHECK POWER SUPPLY AND GROUND CIRCUIT

Check the power supply and the ground circuit of the ABS actuator and electric unit (control unit). Refer to [BRC-86, "Wiring Diagram"](#).

Is the inspection result normal?

- YES (Present error)>>Replace the ABS actuator and electric unit (control unit). Refer to [BRC-107, "Exploded View"](#).
YES (Past error)>>Error was detected in the ABS actuator and electric unit (control unit) branch line.
NO >> Repair the power supply and the ground circuit.

TCM BRANCH LINE CIRCUIT

< DTC/CIRCUIT DIAGNOSIS >

[CAN SYSTEM (TYPE 4)]

TCM BRANCH LINE CIRCUIT

Diagnosis Procedure

INFOID:000000006234360

Regarding Wiring Diagram information, refer to [LAN-28. "Wiring Diagram"](#).

1. CHECK CONNECTOR

1. Turn the ignition switch OFF.
2. Disconnect the battery cable from the negative terminal.
3. Check the following terminals and connectors for damage, bend and loose connection (unit side and connector side).
 - TCM
 - Harness connector F1
 - Harness connector E3

Is the inspection result normal?

- YES >> GO TO 2.
NO >> Repair the terminal and connector.

2. CHECK HARNESS FOR OPEN CIRCUIT

1. Disconnect the connector of TCM.
2. Check the resistance between the TCM harness connector terminals.

TCM harness connector			Resistance (Ω)
Connector No.	Terminal No.		
F15	32	31	Approx. 54 – 66

Is the measurement value within the specification?

- YES >> GO TO 3.
NO >> Repair the TCM branch line.

3. CHECK POWER SUPPLY AND GROUND CIRCUIT

Check the power supply and the ground circuit of the TCM. Refer to [TM-119. "Wiring Diagram"](#).

Is the inspection result normal?

- YES (Present error)>>Replace the TCM. Refer to [TM-161. "Exploded View"](#).
YES (Past error)>>Error was detected in the TCM branch line.
NO >> Repair the power supply and the ground circuit.

A
B
C
D
E
F
G
H
I
J
K
L

LAN

IPDM-E BRANCH LINE CIRCUIT

Diagnosis Procedure

INFOID:000000006234361

Regarding Wiring Diagram information, refer to [LAN-28. "Wiring Diagram"](#).

1. CHECK CONNECTOR

1. Turn the ignition switch OFF.
2. Disconnect the battery cable from the negative terminal.
3. Check the terminals and connectors of the IPDM E/R for damage, bend and loose connection (unit side and connector side).

Is the inspection result normal?

- YES >> GO TO 2.
 NO >> Repair the terminal and connector.

2. CHECK HARNESS FOR OPEN CIRCUIT

1. Disconnect the connector of IPDM E/R.
2. Check the resistance between the IPDM E/R harness connector terminals.

IPDM E/R harness connector			Resistance (Ω)
Connector No.	Terminal No.		
E17	40	39	Approx. 108 – 132

Is the measurement value within the specification?

- YES >> GO TO 3.
 NO >> Repair the IPDM E/R branch line.

3. CHECK POWER SUPPLY AND GROUND CIRCUIT

Check the power supply and the ground circuit of the IPDM E/R. Refer to [PCS-18. "Diagnosis Procedure"](#).

Is the inspection result normal?

- YES (Present error)>>Replace the IPDM E/R. Refer to [PCS-35. "Removal and Installation"](#).
 YES (Past error)>>Error was detected in the IPDM E/R branch line.
 NO >> Repair the power supply and the ground circuit.

CAN COMMUNICATION CIRCUIT

< DTC/CIRCUIT DIAGNOSIS >

[CAN SYSTEM (TYPE 4)]

CAN COMMUNICATION CIRCUIT

Diagnosis Procedure

INFOID:000000006234362

Regarding Wiring Diagram information, refer to [LAN-28. "Wiring Diagram"](#).

1. CONNECTOR INSPECTION

1. Turn the ignition switch OFF.
2. Disconnect the battery cable from the negative terminal.
3. Disconnect all the unit connectors on CAN communication system.
4. Check terminals and connectors for damage, bend and loose connection.

Is the inspection result normal?

YES >> GO TO 2.

NO >> Repair the terminal and connector.

2. CHECK HARNESS CONTINUITY (SHORT CIRCUIT)

Check the continuity between the data link connector terminals.

Data link connector			Continuity
Connector No.	Terminal No.		
M22	6	14	Not existed

Is the inspection result normal?

YES >> GO TO 3.

NO >> Check the harness and repair the root cause.

3. CHECK HARNESS CONTINUITY (SHORT CIRCUIT)

Check the continuity between the data link connector and the ground.

Data link connector		Ground	Continuity
Connector No.	Terminal No.		
M22	6		Not existed
	14		Not existed

Is the inspection result normal?

YES >> GO TO 4.

NO >> Check the harness and repair the root cause.

4. CHECK ECM AND IPDM E/R TERMINATION CIRCUIT

1. Remove the ECM and the IPDM E/R.
2. Check the resistance between the ECM terminals.

ECM		Resistance (Ω)
Terminal No.		
98	97	Approx. 108 – 132

3. Check the resistance between the IPDM E/R terminals.

IPDM E/R		Resistance (Ω)
Terminal No.		
40	39	Approx. 108 – 132

Is the measurement value within the specification?

YES >> GO TO 5.

NO >> Replace the ECM and/or the IPDM E/R.

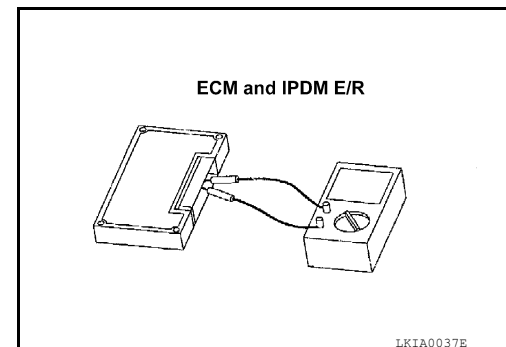

A
B
C
D
E
F
G
H
I
J
K
L
N
O
P

LAN

CAN COMMUNICATION CIRCUIT

< DTC/CIRCUIT DIAGNOSIS >

[CAN SYSTEM (TYPE 4)]

5. CHECK SYMPTOM

Connect all the connectors. Check if the symptoms described in the “Symptom (Results from interview with customer)” are reproduced.

Inspection result

Reproduced>>GO TO 6.

Non-reproduced>>Start the diagnosis again. Follow the trouble diagnosis procedure when past error is detected.

6. CHECK UNIT REPRODUCTION

Perform the reproduction test as per the following procedure for each unit.

1. Turn the ignition switch OFF.
2. Disconnect the battery cable from the negative terminal.
3. Disconnect one of the unit connectors of CAN communication system.

NOTE:

ECM and IPDM E/R have a termination circuit. Check other units first.

4. Connect the battery cable to the negative terminal. Check if the symptoms described in the “Symptom (Results from interview with customer)” are reproduced.

NOTE:

Although unit-related error symptoms occur, do not confuse them with other symptoms.

Inspection result

Reproduced>>Connect the connector. Check other units as per the above procedure.

Non-reproduced>>Replace the unit whose connector was disconnected.

MAIN LINE BETWEEN DLC AND HVAC CIRCUIT

< DTC/CIRCUIT DIAGNOSIS >

[CAN SYSTEM (TYPE 5)]

DTC/CIRCUIT DIAGNOSIS

MAIN LINE BETWEEN DLC AND HVAC CIRCUIT

Diagnosis Procedure

INFOID:000000006234363

Regarding Wiring Diagram information, refer to [LAN-28. "Wiring Diagram"](#).

1. CHECK HARNESS CONTINUITY (OPEN CIRCUIT)

1. Turn the ignition switch OFF.
2. Disconnect the battery cable from the negative terminal.
3. Disconnect the following harness connectors.
 - ECM
 - A/C auto amp.
4. Check the continuity between the data link connector and the A/C auto amp. harness connector.

Data link connector		A/C auto amp. harness connector		Continuity
Connector No.	Terminal No.	Connector No.	Terminal No.	
M22	6	M37	1	Existed
	14		2	Existed

Is the inspection result normal?

YES (Present error)>>Check CAN system type decision again.

YES (Past error)>>Error was detected in the main line between the data link connector and the A/C auto amp.

NO >> Repair the main line between the data link connector and the A/C auto amp.

LAN

MAIN LINE BETWEEN HVAC AND ABS CIRCUIT

< DTC/CIRCUIT DIAGNOSIS >

[CAN SYSTEM (TYPE 5)]

MAIN LINE BETWEEN HVAC AND ABS CIRCUIT

Diagnosis Procedure

INFOID:000000006234364

Regarding Wiring Diagram information, refer to [LAN-28. "Wiring Diagram"](#).

1. CHECK CONNECTOR

1. Turn the ignition switch OFF.
2. Disconnect the battery cable from the negative terminal.
3. Check the following terminals and connectors for damage, bend and loose connection (connector side and harness side).
 - Harness connector M1
 - Harness connector E30

Is the inspection result normal?

- YES >> GO TO 2.
NO >> Repair the terminal and connector.

2. CHECK HARNESS CONTINUITY (OPEN CIRCUIT)

1. Disconnect the following harness connectors.
 - A/C auto amp.
 - Harness connectors M1 and E30
2. Check the continuity between the A/C auto amp. harness connector and the harness connector.

A/C auto amp. harness connector		Harness connector		Continuity
Connector No.	Terminal No.	Connector No.	Terminal No.	
M37	1	M1	15G	Existed
	2		8G	Existed

Is the inspection result normal?

- YES >> GO TO 3.
NO >> Repair the main line between the A/C auto amp. and the harness connector M1.

3. CHECK HARNESS CONTINUITY (OPEN CIRCUIT)

1. Disconnect the connector of ABS actuator and electric unit (control unit).
2. Check the continuity between the harness connector and the ABS actuator and electric unit (control unit) harness connector.

Harness connector		ABS actuator and electric unit (control unit) harness connector		Continuity
Connector No.	Terminal No.	Connector No.	Terminal No.	
E30	15G	E26	26	Existed
	8G		15	Existed

Is the inspection result normal?

- YES (Present error)>>Check CAN system type decision again.
YES (Past error)>>Error was detected in the main line between the A/C auto amp. and the ABS actuator and electric unit (control unit).
NO >> Repair the main line between the harness connector E30 and the ABS actuator and electric unit (control unit).

ECM BRANCH LINE CIRCUIT

Diagnosis Procedure

INFOID:000000006234365

Regarding Wiring Diagram information, refer to [LAN-28. "Wiring Diagram"](#).

1. CHECK CONNECTOR

1. Turn the ignition switch OFF.
2. Disconnect the battery cable from the negative terminal.
3. Check the following terminals and connectors for damage, bend and loose connection (unit side and connector side).
 - Models without automatic drive positioner
 - ECM
 - Harness connector E30
 - Harness connector M1
 - Models with automatic drive positioner
 - ECM
 - Harness connector E29
 - Harness connector B10

Is the inspection result normal?

- YES >> GO TO 2.
 NO >> Repair the terminal and connector.

2. CHECK HARNESS FOR OPEN CIRCUIT

1. Disconnect the connector of ECM.
2. Check the resistance between the ECM harness connector terminals.

ECM harness connector		Resistance (Ω)
Connector No.	Terminal No.	
E10	98 97	Approx. 108 – 132

Is the measurement value within the specification?

- YES >> GO TO 3.
 NO >> Repair the ECM branch line.

3. CHECK POWER SUPPLY AND GROUND CIRCUIT

Check the power supply and the ground circuit of the ECM. Refer to [EC-154. "Diagnosis Procedure"](#).

Is the inspection result normal?

- YES (Present error)>>Replace the ECM. Refer to [EC-17. "ADDITIONAL SERVICE WHEN REPLACING CONTROL UNIT : Description"](#).
 YES (Past error)>>Error was detected in the ECM branch line.
 NO >> Repair the power supply and the ground circuit.

LAN

BCM BRANCH LINE CIRCUIT

Diagnosis Procedure

INFOID:000000006234366

Regarding Wiring Diagram information, refer to [LAN-28, "Wiring Diagram"](#).

1. CHECK CONNECTOR

1. Turn the ignition switch OFF.
2. Disconnect the battery cable from the negative terminal.
3. Check the terminals and connectors of the BCM for damage, bend and loose connection (unit side and connector side).

Is the inspection result normal?

- YES >> GO TO 2.
 NO >> Repair the terminal and connector.

2. CHECK HARNESS FOR OPEN CIRCUIT

1. Disconnect the connector of BCM.
2. Check the resistance between the BCM harness connector terminals.

BCM harness connector			Resistance (Ω)
Connector No.	Terminal No.		
M19	79	78	Approx. 54 – 66

Is the measurement value within the specification?

- YES >> GO TO 3.
 NO >> Repair the BCM branch line.

3. CHECK POWER SUPPLY AND GROUND CIRCUIT

Check the power supply and the ground circuit of the BCM. Refer to [BCS-36, "Diagnosis Procedure"](#).

Is the inspection result normal?

- YES (Present error)>>Replace the BCM. Refer to [BCS-80, "Removal and Installation"](#).
 YES (Past error)>>Error was detected in the BCM branch line.
 NO >> Repair the power supply and the ground circuit.

DLC BRANCH LINE CIRCUIT

< DTC/CIRCUIT DIAGNOSIS >

[CAN SYSTEM (TYPE 5)]

DLC BRANCH LINE CIRCUIT

Diagnosis Procedure

INFOID:000000006234367

Regarding Wiring Diagram information, refer to [LAN-28. "Wiring Diagram"](#).

1. CHECK CONNECTOR

1. Turn the ignition switch OFF.
2. Disconnect the battery cable from the negative terminal.
3. Check the terminals and connectors of the data link connector for damage, bend and loose connection (connector side and harness side).

Is the inspection result normal?

YES >> GO TO 2.

NO >> Repair the terminal and connector.

2. CHECK HARNESS FOR OPEN CIRCUIT

Check the resistance between the data link connector terminals.

Data link connector			Resistance (Ω)
Connector No.	Terminal No.		
M22	6	14	Approx. 54 – 66

Is the measurement value within the specification?

YES (Present error)>>Check CAN system type decision again.

YES (Past error)>>Error was detected in the data link connector branch line circuit.

NO >> Repair the data link connector branch line.

A
B
C
D
E
F
G
H
I
J
K
L

LAN

N
O
P

M&A BRANCH LINE CIRCUIT

Diagnosis Procedure

INFOID:000000006234368

Regarding Wiring Diagram information, refer to [LAN-28. "Wiring Diagram"](#).

1. CHECK CONNECTOR

1. Turn the ignition switch OFF.
2. Disconnect the battery cable from the negative terminal.
3. Check the terminals and connectors of the combination meter for damage, bend and loose connection (unit side and connector side).

Is the inspection result normal?

- YES >> GO TO 2.
 NO >> Repair the terminal and connector.

2. CHECK HARNESS FOR OPEN CIRCUIT

1. Disconnect the connector of combination meter.
2. Check the resistance between the combination meter harness connector terminals.

Combination meter harness connector			Resistance (Ω)
Connector No.	Terminal No.		
M24	21	22	Approx. 54 – 66

Is the measurement value within the specification?

- YES >> GO TO 3.
 NO >> Repair the combination meter branch line.

3. CHECK POWER SUPPLY AND GROUND CIRCUIT

Check the power supply and the ground circuit of the combination meter. Refer to [MWI-37. "COMBINATION METER : Diagnosis Procedure"](#).

Is the inspection result normal?

- YES (Present error)>>Replace the combination meter. Refer to [MWI-119. "Removal and Installation"](#).
 YES (Past error)>>Error was detected in the combination meter branch line.
 NO >> Repair the power supply and the ground circuit.

HVAC BRANCH LINE CIRCUIT

Diagnosis Procedure

INFOID:000000006234369

Regarding Wiring Diagram information, refer to [LAN-28, "Wiring Diagram"](#).

1. CHECK CONNECTOR

1. Turn the ignition switch OFF.
2. Disconnect the battery cable from the negative terminal.
3. Check the terminals and connectors of the A/C auto amp. for damage, bend and loose connection (unit side and connector side).

Is the inspection result normal?

- YES >> GO TO 2.
 NO >> Repair the terminal and connector.

2. CHECK HARNESS FOR OPEN CIRCUIT

1. Disconnect the connector of A/C auto amp.
2. Check the resistance between the A/C auto amp. harness connector terminals.

A/C auto amp. harness connector			Resistance (Ω)
Connector No.	Terminal No.		
M37	1	2	Approx. 54 – 66

Is the measurement value within the specification?

- YES >> GO TO 3.
 NO >> Repair the A/C auto amp. branch line.

3. CHECK POWER SUPPLY AND GROUND CIRCUIT

Check the power supply and the ground circuit of the A/C auto amp. Refer to the following.

- Models with color display: [HAC-60, "A/C AUTO AMP. : Diagnosis Procedure"](#)
- Models with monochrome display: [HAC-168, "A/C AUTO AMP. : Diagnosis Procedure"](#)

Is the inspection result normal?

- YES (Present error)>>Replace the A/C auto amp. Refer to the following.
- Models with color display: [HAC-104, "Removal and Installation"](#)
 - Models monochrome display: [HAC-212, "Removal and Installation"](#)
- YES (Past error)>>Error was detected in the A/C auto amp. branch line.
 NO >> Repair the power supply and the ground circuit.

A
B
C
D
E
F
G
H
I
J
K
L

LAN

N
O
P

STRG BRANCH LINE CIRCUIT

< DTC/CIRCUIT DIAGNOSIS >

[CAN SYSTEM (TYPE 5)]

STRG BRANCH LINE CIRCUIT

Diagnosis Procedure

INFOID:000000006234370

Regarding Wiring Diagram information, refer to [LAN-28. "Wiring Diagram"](#).

1. CHECK CONNECTOR

1. Turn the ignition switch OFF.
2. Disconnect the battery cable from the negative terminal.
3. Check the terminals and connectors of the steering angle sensor for damage, bend and loose connection (unit side and connector side).

Is the inspection result normal?

- YES >> GO TO 2.
NO >> Repair the terminal and connector.

2. CHECK HARNESS FOR OPEN CIRCUIT

1. Disconnect the connector of steering angle sensor.
2. Check the resistance between the steering angle sensor harness connector terminals.

Steering angle sensor harness connector			Resistance (Ω)
Connector No.	Terminal No.		
M53	5	2	Approx. 54 – 66

Is the measurement value within the specification?

- YES >> GO TO 3.
NO >> Repair the steering angle sensor branch line.

3. CHECK POWER SUPPLY AND GROUND CIRCUIT

Check the power supply and the ground circuit of the steering angle sensor. Refer to [BRC-86. "Wiring Diagram"](#).

Is the inspection result normal?

- YES (Present error)>>Replace the steering angle sensor. Refer to [BRC-110. "Removal and Installation"](#).
YES (Past error)>>Error was detected in the steering angle sensor branch line.
NO >> Repair the power supply and the ground circuit.

ABS BRANCH LINE CIRCUIT

< DTC/CIRCUIT DIAGNOSIS >

[CAN SYSTEM (TYPE 5)]

ABS BRANCH LINE CIRCUIT

Diagnosis Procedure

INFOID:000000006234371

Regarding Wiring Diagram information, refer to [LAN-28. "Wiring Diagram"](#).

1. CHECK CONNECTOR

1. Turn the ignition switch OFF.
2. Disconnect the battery cable from the negative terminal.
3. Check the terminals and connectors of the ABS actuator and electric unit (control unit) for damage, bend and loose connection (unit side and connector side).

Is the inspection result normal?

YES >> GO TO 2.

NO >> Repair the terminal and connector.

2. CHECK HARNESS FOR OPEN CIRCUIT

1. Disconnect the connector of ABS actuator and electric unit (control unit).
2. Check the resistance between the ABS actuator and electric unit (control unit) harness connector terminals.

ABS actuator and electric unit (control unit) harness connector			Resistance (Ω)
Connector No.	Terminal No.		
E26	26	15	Approx. 54 – 66

Is the measurement value within the specification?

YES >> GO TO 3.

NO >> Repair the ABS actuator and electric unit (control unit) branch line.

3. CHECK POWER SUPPLY AND GROUND CIRCUIT

Check the power supply and the ground circuit of the ABS actuator and electric unit (control unit). Refer to [BRC-86. "Wiring Diagram"](#).

Is the inspection result normal?

YES (Present error)>>Replace the ABS actuator and electric unit (control unit). Refer to [BRC-107. "Exploded View"](#).

YES (Past error)>>Error was detected in the ABS actuator and electric unit (control unit) branch line.

NO >> Repair the power supply and the ground circuit.

A
B
C
D
E
F
G
H
I
J
K
L

LAN

TCM BRANCH LINE CIRCUIT

Diagnosis Procedure

INFOID:000000006234372

Regarding Wiring Diagram information, refer to [LAN-28, "Wiring Diagram"](#).

1. CHECK CONNECTOR

1. Turn the ignition switch OFF.
2. Disconnect the battery cable from the negative terminal.
3. Check the following terminals and connectors for damage, bend and loose connection (unit side and connector side).
 - TCM
 - Harness connector F1
 - Harness connector E3

Is the inspection result normal?

- YES >> GO TO 2.
 NO >> Repair the terminal and connector.

2. CHECK HARNESS FOR OPEN CIRCUIT

1. Disconnect the connector of TCM.
2. Check the resistance between the TCM harness connector terminals.

TCM harness connector			Resistance (Ω)
Connector No.	Terminal No.		
F15	32	31	Approx. 54 – 66

Is the measurement value within the specification?

- YES >> GO TO 3.
 NO >> Repair the TCM branch line.

3. CHECK POWER SUPPLY AND GROUND CIRCUIT

Check the power supply and the ground circuit of the TCM. Refer to [TM-119, "Wiring Diagram"](#).

Is the inspection result normal?

- YES (Present error)>>Replace the TCM. Refer to [TM-161, "Exploded View"](#).
 YES (Past error)>>Error was detected in the TCM branch line.
 NO >> Repair the power supply and the ground circuit.

IPDM-E BRANCH LINE CIRCUIT

Diagnosis Procedure

INFOID:000000006234373

Regarding Wiring Diagram information, refer to [LAN-28. "Wiring Diagram"](#).

1. CHECK CONNECTOR

1. Turn the ignition switch OFF.
2. Disconnect the battery cable from the negative terminal.
3. Check the terminals and connectors of the IPDM E/R for damage, bend and loose connection (unit side and connector side).

Is the inspection result normal?

- YES >> GO TO 2.
 NO >> Repair the terminal and connector.

2. CHECK HARNESS FOR OPEN CIRCUIT

1. Disconnect the connector of IPDM E/R.
2. Check the resistance between the IPDM E/R harness connector terminals.

IPDM E/R harness connector			Resistance (Ω)
Connector No.	Terminal No.		
E17	40	39	Approx. 108 – 132

Is the measurement value within the specification?

- YES >> GO TO 3.
 NO >> Repair the IPDM E/R branch line.

3. CHECK POWER SUPPLY AND GROUND CIRCUIT

Check the power supply and the ground circuit of the IPDM E/R. Refer to [PCS-18. "Diagnosis Procedure"](#).

Is the inspection result normal?

- YES (Present error)>>Replace the IPDM E/R. Refer to [PCS-35. "Removal and Installation"](#).
 YES (Past error)>>Error was detected in the IPDM E/R branch line.
 NO >> Repair the power supply and the ground circuit.

LAN

CAN COMMUNICATION CIRCUIT

< DTC/CIRCUIT DIAGNOSIS >

[CAN SYSTEM (TYPE 5)]

CAN COMMUNICATION CIRCUIT

Diagnosis Procedure

INFOID:00000006234374

Regarding Wiring Diagram information, refer to [LAN-28. "Wiring Diagram"](#).

1. CONNECTOR INSPECTION

1. Turn the ignition switch OFF.
2. Disconnect the battery cable from the negative terminal.
3. Disconnect all the unit connectors on CAN communication system.
4. Check terminals and connectors for damage, bend and loose connection.

Is the inspection result normal?

- YES >> GO TO 2.
NO >> Repair the terminal and connector.

2. CHECK HARNESS CONTINUITY (SHORT CIRCUIT)

Check the continuity between the data link connector terminals.

Data link connector			Continuity
Connector No.	Terminal No.		
M22	6	14	Not existed

Is the inspection result normal?

- YES >> GO TO 3.
NO >> Check the harness and repair the root cause.

3. CHECK HARNESS CONTINUITY (SHORT CIRCUIT)

Check the continuity between the data link connector and the ground.

Data link connector		Ground	Continuity
Connector No.	Terminal No.		
M22	6		Not existed
	14		Not existed

Is the inspection result normal?

- YES >> GO TO 4.
NO >> Check the harness and repair the root cause.

4. CHECK ECM AND IPDM E/R TERMINATION CIRCUIT

1. Remove the ECM and the IPDM E/R.
2. Check the resistance between the ECM terminals.

ECM		Resistance (Ω)
Terminal No.		
98	97	Approx. 108 – 132

3. Check the resistance between the IPDM E/R terminals.

IPDM E/R		Resistance (Ω)
Terminal No.		
40	39	Approx. 108 – 132

Is the measurement value within the specification?

- YES >> GO TO 5.
NO >> Replace the ECM and/or the IPDM E/R.

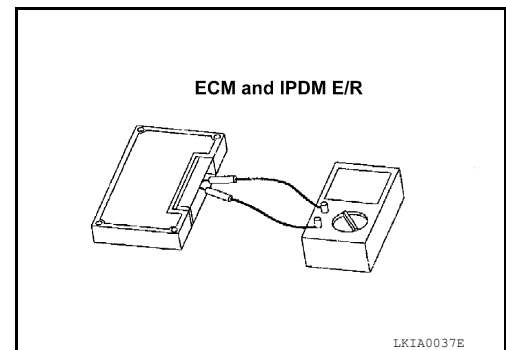

CAN COMMUNICATION CIRCUIT

< DTC/CIRCUIT DIAGNOSIS >

[CAN SYSTEM (TYPE 5)]

5.CHECK SYMPTOM

Connect all the connectors. Check if the symptoms described in the “Symptom (Results from interview with customer)” are reproduced.

Inspection result

Reproduced>>GO TO 6.

Non-reproduced>>Start the diagnosis again. Follow the trouble diagnosis procedure when past error is detected.

6.CHECK UNIT REPRODUCTION

Perform the reproduction test as per the following procedure for each unit.

1. Turn the ignition switch OFF.
2. Disconnect the battery cable from the negative terminal.
3. Disconnect one of the unit connectors of CAN communication system.

NOTE:

ECM and IPDM E/R have a termination circuit. Check other units first.

4. Connect the battery cable to the negative terminal. Check if the symptoms described in the “Symptom (Results from interview with customer)” are reproduced.

NOTE:

Although unit-related error symptoms occur, do not confuse them with other symptoms.

Inspection result

Reproduced>>Connect the connector. Check other units as per the above procedure.

Non-reproduced>>Replace the unit whose connector was disconnected.

A
B
C
D
E
F
G
H
I
J
K
L

LAN

N
O
P

MAIN LINE BETWEEN ADP AND DLC CIRCUIT

< DTC/CIRCUIT DIAGNOSIS >

[CAN SYSTEM (TYPE 6)]

DTC/CIRCUIT DIAGNOSIS

MAIN LINE BETWEEN ADP AND DLC CIRCUIT

Diagnosis Procedure

INFOID:000000006234375

Regarding Wiring Diagram information, refer to [LAN-28, "Wiring Diagram"](#).

1. CHECK CONNECTOR

1. Turn the ignition switch OFF.
2. Disconnect the battery cable from the negative terminal.
3. Check the following terminals and connectors for damage, bend and loose connection (connector side and harness side).
 - Harness connector B1
 - Harness connector M6

Is the inspection result normal?

- YES >> GO TO 2.
NO >> Repair the terminal and connector.

2. CHECK HARNESS CONTINUITY (OPEN CIRCUIT)

1. Disconnect the following harness connectors.
 - Harness connectors B208 and B32
 - Harness connectors B1 and M6
2. Check the continuity between the harness connectors.

Harness connector		Harness connector		Continuity
Connector No.	Terminal No.	Connector No.	Terminal No.	
B32	9	B1	15J	Existed
	10		16J	Existed

Is the inspection result normal?

- YES >> GO TO 3.
NO >> Repair the main line between the harness connectors B32 and B1.

3. CHECK HARNESS CONTINUITY (OPEN CIRCUIT)

Check the continuity between the harness connector and the data link connector.

Harness connector		Data link connector		Continuity
Connector No.	Terminal No.	Connector No.	Terminal No.	
M6	15J	M22	6	Existed
	16J		14	Existed

Is the inspection result normal?

- YES (Present error)>>Check CAN system type decision again.
YES (Past error)>>Error was detected in the main line between the driver seat control unit and the data link connector.
NO >> Repair the main line between the harness connector M6 and the data link connector.

MAIN LINE BETWEEN DLC AND HVAC CIRCUIT

< DTC/CIRCUIT DIAGNOSIS >

[CAN SYSTEM (TYPE 6)]

MAIN LINE BETWEEN DLC AND HVAC CIRCUIT

Diagnosis Procedure

INFOID:000000006234376

Regarding Wiring Diagram information, refer to [LAN-28. "Wiring Diagram"](#).

1. CHECK HARNESS CONTINUITY (OPEN CIRCUIT)

1. Turn the ignition switch OFF.
2. Disconnect the battery cable from the negative terminal.
3. Disconnect the following harness connectors.
 - ECM
 - A/C auto amp.
4. Check the continuity between the data link connector and the A/C auto amp. harness connector.

Data link connector		A/C auto amp. harness connector		Continuity
Connector No.	Terminal No.	Connector No.	Terminal No.	
M22	6	M37	1	Existed
	14		2	Existed

Is the inspection result normal?

YES (Present error)>>Check CAN system type decision again.

YES (Past error)>>Error was detected in the main line between the data link connector and the A/C auto amp.

NO >> Repair the main line between the data link connector and the A/C auto amp.

A
B
C
D
E
F
G
H
I
J
K
L
N
O
P

LAN

MAIN LINE BETWEEN HVAC AND ABS CIRCUIT

< DTC/CIRCUIT DIAGNOSIS >

[CAN SYSTEM (TYPE 6)]

MAIN LINE BETWEEN HVAC AND ABS CIRCUIT

Diagnosis Procedure

INFOID:00000006234377

Regarding Wiring Diagram information, refer to [LAN-28. "Wiring Diagram"](#).

1. CHECK CONNECTOR

1. Turn the ignition switch OFF.
2. Disconnect the battery cable from the negative terminal.
3. Check the following terminals and connectors for damage, bend and loose connection (connector side and harness side).
 - Harness connector M1
 - Harness connector E30

Is the inspection result normal?

- YES >> GO TO 2.
NO >> Repair the terminal and connector.

2. CHECK HARNESS CONTINUITY (OPEN CIRCUIT)

1. Disconnect the following harness connectors.
 - A/C auto amp.
 - Harness connectors M1 and E30
2. Check the continuity between the A/C auto amp. harness connector and the harness connector.

A/C auto amp. harness connector		Harness connector		Continuity
Connector No.	Terminal No.	Connector No.	Terminal No.	
M37	1	M1	15G	Existed
	2		8G	Existed

Is the inspection result normal?

- YES >> GO TO 3.
NO >> Repair the main line between the A/C auto amp. and the harness connector M1.

3. CHECK HARNESS CONTINUITY (OPEN CIRCUIT)

1. Disconnect the connector of ABS actuator and electric unit (control unit).
2. Check the continuity between the harness connector and the ABS actuator and electric unit (control unit) harness connector.

Harness connector		ABS actuator and electric unit (control unit) harness connector		Continuity
Connector No.	Terminal No.	Connector No.	Terminal No.	
E30	15G	E26	26	Existed
	8G		15	Existed

Is the inspection result normal?

- YES (Present error)>>Check CAN system type decision again.
YES (Past error)>>Error was detected in the main line between the A/C auto amp. and the ABS actuator and electric unit (control unit).
NO >> Repair the main line between the harness connector E30 and the ABS actuator and electric unit (control unit).

ECM BRANCH LINE CIRCUIT

Diagnosis Procedure

INFOID:000000006234378

Regarding Wiring Diagram information, refer to [LAN-28. "Wiring Diagram"](#).

1. CHECK CONNECTOR

1. Turn the ignition switch OFF.
2. Disconnect the battery cable from the negative terminal.
3. Check the following terminals and connectors for damage, bend and loose connection (unit side and connector side).
 - Models without automatic drive positioner
 - ECM
 - Harness connector E30
 - Harness connector M1
 - Models with automatic drive positioner
 - ECM
 - Harness connector E29
 - Harness connector B10

Is the inspection result normal?

- YES >> GO TO 2.
- NO >> Repair the terminal and connector.

2. CHECK HARNESS FOR OPEN CIRCUIT

1. Disconnect the connector of ECM.
2. Check the resistance between the ECM harness connector terminals.

ECM harness connector		Resistance (Ω)
Connector No.	Terminal No.	
E10	98 97	Approx. 108 – 132

Is the measurement value within the specification?

- YES >> GO TO 3.
- NO >> Repair the ECM branch line.

3. CHECK POWER SUPPLY AND GROUND CIRCUIT

Check the power supply and the ground circuit of the ECM. Refer to [EC-154. "Diagnosis Procedure"](#).

Is the inspection result normal?

- YES (Present error)>>Replace the ECM. Refer to [EC-17. "ADDITIONAL SERVICE WHEN REPLACING CONTROL UNIT : Description"](#).
- YES (Past error)>>Error was detected in the ECM branch line.
- NO >> Repair the power supply and the ground circuit.

LAN

ADP BRANCH LINE CIRCUIT

Diagnosis Procedure

INFOID:00000006234379

Regarding Wiring Diagram information, refer to [LAN-28. "Wiring Diagram"](#).

1. CHECK CONNECTOR

1. Turn the ignition switch OFF.
2. Disconnect the battery cable from the negative terminal.
3. Check the following terminals and connectors for damage, bend and loose connection (unit side and connector side).
 - Driver seat control unit
 - Harness connector B208
 - Harness connector B32

Is the inspection result normal?

- YES >> GO TO 2.
 NO >> Repair the terminal and connector.

2. CHECK HARNESS FOR OPEN CIRCUIT

1. Disconnect the connector of driver seat control unit.
2. Check the resistance between the driver seat control unit harness connector terminals.

Driver seat control unit harness connector			Resistance (Ω)
Connector No.	Terminal No.		
B203	16	32	Approx. 54 – 66

Is the measurement value within the specification?

- YES >> GO TO 3.
 NO >> Repair the driver seat control unit branch line.

3. CHECK POWER SUPPLY AND GROUND CIRCUIT

Check the power supply and the ground circuit of the driver seat control unit. Refer to [ADP-48. "DRIVER SEAT CONTROL UNIT : Diagnosis Procedure"](#).

Is the inspection result normal?

- YES (Present error)>>Replace the driver seat control unit. Refer to [ADP-171. "Removal and Installation"](#).
 YES (Past error)>>Error was detected in the driver seat control unit branch line.
 NO >> Repair the power supply and the ground circuit.

BCM BRANCH LINE CIRCUIT

Diagnosis Procedure

INFOID:000000006234380

Regarding Wiring Diagram information, refer to [LAN-28. "Wiring Diagram"](#).

1. CHECK CONNECTOR

1. Turn the ignition switch OFF.
2. Disconnect the battery cable from the negative terminal.
3. Check the terminals and connectors of the BCM for damage, bend and loose connection (unit side and connector side).

Is the inspection result normal?

- YES >> GO TO 2.
 NO >> Repair the terminal and connector.

2. CHECK HARNESS FOR OPEN CIRCUIT

1. Disconnect the connector of BCM.
2. Check the resistance between the BCM harness connector terminals.

BCM harness connector			Resistance (Ω)
Connector No.	Terminal No.		
M19	79	78	Approx. 54 – 66

Is the measurement value within the specification?

- YES >> GO TO 3.
 NO >> Repair the BCM branch line.

3. CHECK POWER SUPPLY AND GROUND CIRCUIT

Check the power supply and the ground circuit of the BCM. Refer to [BCS-36. "Diagnosis Procedure"](#).

Is the inspection result normal?

- YES (Present error)>>Replace the BCM. Refer to [BCS-80. "Removal and Installation"](#).
 YES (Past error)>>Error was detected in the BCM branch line.
 NO >> Repair the power supply and the ground circuit.

A
B
C
D
E
F
G
H
I
J
K
L

LAN

DLC BRANCH LINE CIRCUIT

Diagnosis Procedure

INFOID:000000006234381

Regarding Wiring Diagram information, refer to [LAN-28. "Wiring Diagram"](#).

1. CHECK CONNECTOR

1. Turn the ignition switch OFF.
2. Disconnect the battery cable from the negative terminal.
3. Check the terminals and connectors of the data link connector for damage, bend and loose connection (connector side and harness side).

Is the inspection result normal?

- YES >> GO TO 2.
 NO >> Repair the terminal and connector.

2. CHECK HARNESS FOR OPEN CIRCUIT

Check the resistance between the data link connector terminals.

Data link connector			Resistance (Ω)
Connector No.	Terminal No.		
M22	6	14	Approx. 54 – 66

Is the measurement value within the specification?

- YES (Present error)>>Check CAN system type decision again.
 YES (Past error)>>Error was detected in the data link connector branch line circuit.
 NO >> Repair the data link connector branch line.

M&A BRANCH LINE CIRCUIT

Diagnosis Procedure

INFOID:000000006234382

Regarding Wiring Diagram information, refer to [LAN-28. "Wiring Diagram"](#).

1. CHECK CONNECTOR

1. Turn the ignition switch OFF.
2. Disconnect the battery cable from the negative terminal.
3. Check the terminals and connectors of the combination meter for damage, bend and loose connection (unit side and connector side).

Is the inspection result normal?

- YES >> GO TO 2.
 NO >> Repair the terminal and connector.

2. CHECK HARNESS FOR OPEN CIRCUIT

1. Disconnect the connector of combination meter.
2. Check the resistance between the combination meter harness connector terminals.

Combination meter harness connector			Resistance (Ω)
Connector No.	Terminal No.		
M24	21	22	Approx. 54 – 66

Is the measurement value within the specification?

- YES >> GO TO 3.
 NO >> Repair the combination meter branch line.

3. CHECK POWER SUPPLY AND GROUND CIRCUIT

Check the power supply and the ground circuit of the combination meter. Refer to [MWI-37. "COMBINATION METER : Diagnosis Procedure"](#).

Is the inspection result normal?

- YES (Present error)>>Replace the combination meter. Refer to [MWI-119. "Removal and Installation"](#).
 YES (Past error)>>Error was detected in the combination meter branch line.
 NO >> Repair the power supply and the ground circuit.

LAN

HVAC BRANCH LINE CIRCUIT

Diagnosis Procedure

INFOID:000000006234383

Regarding Wiring Diagram information, refer to [LAN-28, "Wiring Diagram"](#).

1. CHECK CONNECTOR

1. Turn the ignition switch OFF.
2. Disconnect the battery cable from the negative terminal.
3. Check the terminals and connectors of the A/C auto amp. for damage, bend and loose connection (unit side and connector side).

Is the inspection result normal?

- YES >> GO TO 2.
 NO >> Repair the terminal and connector.

2. CHECK HARNESS FOR OPEN CIRCUIT

1. Disconnect the connector of A/C auto amp.
2. Check the resistance between the A/C auto amp. harness connector terminals.

A/C auto amp. harness connector			Resistance (Ω)
Connector No.	Terminal No.		
M37	1	2	Approx. 54 – 66

Is the measurement value within the specification?

- YES >> GO TO 3.
 NO >> Repair the A/C auto amp. branch line.

3. CHECK POWER SUPPLY AND GROUND CIRCUIT

Check the power supply and the ground circuit of the A/C auto amp. Refer to the following.

- Models with color display: [HAC-60, "A/C AUTO AMP. : Diagnosis Procedure"](#)
- Models with monochrome display: [HAC-168, "A/C AUTO AMP. : Diagnosis Procedure"](#)

Is the inspection result normal?

- YES (Present error)>>Replace the A/C auto amp. Refer to the following.
- Models with color display: [HAC-104, "Removal and Installation"](#)
 - Models monochrome display: [HAC-212, "Removal and Installation"](#)
- YES (Past error)>>Error was detected in the A/C auto amp. branch line.
 NO >> Repair the power supply and the ground circuit.

STRG BRANCH LINE CIRCUIT

< DTC/CIRCUIT DIAGNOSIS >

[CAN SYSTEM (TYPE 6)]

STRG BRANCH LINE CIRCUIT

Diagnosis Procedure

INFOID:000000006234384

Regarding Wiring Diagram information, refer to [LAN-28. "Wiring Diagram"](#).

1. CHECK CONNECTOR

1. Turn the ignition switch OFF.
2. Disconnect the battery cable from the negative terminal.
3. Check the terminals and connectors of the steering angle sensor for damage, bend and loose connection (unit side and connector side).

Is the inspection result normal?

YES >> GO TO 2.

NO >> Repair the terminal and connector.

2. CHECK HARNESS FOR OPEN CIRCUIT

1. Disconnect the connector of steering angle sensor.
2. Check the resistance between the steering angle sensor harness connector terminals.

Steering angle sensor harness connector			Resistance (Ω)
Connector No.	Terminal No.		
M53	5	2	Approx. 54 – 66

Is the measurement value within the specification?

YES >> GO TO 3.

NO >> Repair the steering angle sensor branch line.

3. CHECK POWER SUPPLY AND GROUND CIRCUIT

Check the power supply and the ground circuit of the steering angle sensor. Refer to [BRC-86. "Wiring Diagram"](#).

Is the inspection result normal?

YES (Present error)>>Replace the steering angle sensor. Refer to [BRC-110. "Removal and Installation"](#).

YES (Past error)>>Error was detected in the steering angle sensor branch line.

NO >> Repair the power supply and the ground circuit.

A
B
C
D
E
F
G
H
I
J
K
L

LAN

N
O
P

ABS BRANCH LINE CIRCUIT

< DTC/CIRCUIT DIAGNOSIS >

[CAN SYSTEM (TYPE 6)]

ABS BRANCH LINE CIRCUIT

Diagnosis Procedure

INFOID:000000006234385

Regarding Wiring Diagram information, refer to [LAN-28, "Wiring Diagram"](#).

1. CHECK CONNECTOR

1. Turn the ignition switch OFF.
2. Disconnect the battery cable from the negative terminal.
3. Check the terminals and connectors of the ABS actuator and electric unit (control unit) for damage, bend and loose connection (unit side and connector side).

Is the inspection result normal?

- YES >> GO TO 2.
NO >> Repair the terminal and connector.

2. CHECK HARNESS FOR OPEN CIRCUIT

1. Disconnect the connector of ABS actuator and electric unit (control unit).
2. Check the resistance between the ABS actuator and electric unit (control unit) harness connector terminals.

ABS actuator and electric unit (control unit) harness connector			Resistance (Ω)
Connector No.	Terminal No.		
E26	26	15	Approx. 54 – 66

Is the measurement value within the specification?

- YES >> GO TO 3.
NO >> Repair the ABS actuator and electric unit (control unit) branch line.

3. CHECK POWER SUPPLY AND GROUND CIRCUIT

Check the power supply and the ground circuit of the ABS actuator and electric unit (control unit). Refer to [BRC-86, "Wiring Diagram"](#).

Is the inspection result normal?

- YES (Present error)>>Replace the ABS actuator and electric unit (control unit). Refer to [BRC-107, "Exploded View"](#).
YES (Past error)>>Error was detected in the ABS actuator and electric unit (control unit) branch line.
NO >> Repair the power supply and the ground circuit.

TCM BRANCH LINE CIRCUIT

Diagnosis Procedure

INFOID:000000006234386

Regarding Wiring Diagram information, refer to [LAN-28. "Wiring Diagram"](#).

1. CHECK CONNECTOR

1. Turn the ignition switch OFF.
2. Disconnect the battery cable from the negative terminal.
3. Check the following terminals and connectors for damage, bend and loose connection (unit side and connector side).
 - TCM
 - Harness connector F1
 - Harness connector E3

Is the inspection result normal?

YES >> GO TO 2.

NO >> Repair the terminal and connector.

2. CHECK HARNESS FOR OPEN CIRCUIT

1. Disconnect the connector of TCM.
2. Check the resistance between the TCM harness connector terminals.

TCM harness connector			Resistance (Ω)
Connector No.	Terminal No.		
F15	32	31	Approx. 54 – 66

Is the measurement value within the specification?

YES >> GO TO 3.

NO >> Repair the TCM branch line.

3. CHECK POWER SUPPLY AND GROUND CIRCUIT

Check the power supply and the ground circuit of the TCM. Refer to [TM-119. "Wiring Diagram"](#).

Is the inspection result normal?

YES (Present error)>>Replace the TCM. Refer to [TM-161. "Exploded View"](#).

YES (Past error)>>Error was detected in the TCM branch line.

NO >> Repair the power supply and the ground circuit.

LAN

IPDM-E BRANCH LINE CIRCUIT

Diagnosis Procedure

INFOID:000000006234387

Regarding Wiring Diagram information, refer to [LAN-28. "Wiring Diagram"](#).

1. CHECK CONNECTOR

1. Turn the ignition switch OFF.
2. Disconnect the battery cable from the negative terminal.
3. Check the terminals and connectors of the IPDM E/R for damage, bend and loose connection (unit side and connector side).

Is the inspection result normal?

- YES >> GO TO 2.
 NO >> Repair the terminal and connector.

2. CHECK HARNESS FOR OPEN CIRCUIT

1. Disconnect the connector of IPDM E/R.
2. Check the resistance between the IPDM E/R harness connector terminals.

IPDM E/R harness connector			Resistance (Ω)
Connector No.	Terminal No.		
E17	40	39	Approx. 108 – 132

Is the measurement value within the specification?

- YES >> GO TO 3.
 NO >> Repair the IPDM E/R branch line.

3. CHECK POWER SUPPLY AND GROUND CIRCUIT

Check the power supply and the ground circuit of the IPDM E/R. Refer to [PCS-18. "Diagnosis Procedure"](#).

Is the inspection result normal?

- YES (Present error)>>Replace the IPDM E/R. Refer to [PCS-35. "Removal and Installation"](#).
 YES (Past error)>>Error was detected in the IPDM E/R branch line.
 NO >> Repair the power supply and the ground circuit.

CAN COMMUNICATION CIRCUIT

< DTC/CIRCUIT DIAGNOSIS >

[CAN SYSTEM (TYPE 6)]

CAN COMMUNICATION CIRCUIT

Diagnosis Procedure

INFOID:00000006234388

Regarding Wiring Diagram information, refer to [LAN-28. "Wiring Diagram"](#).

1. CONNECTOR INSPECTION

1. Turn the ignition switch OFF.
2. Disconnect the battery cable from the negative terminal.
3. Disconnect all the unit connectors on CAN communication system.
4. Check terminals and connectors for damage, bend and loose connection.

Is the inspection result normal?

YES >> GO TO 2.

NO >> Repair the terminal and connector.

2. CHECK HARNESS CONTINUITY (SHORT CIRCUIT)

Check the continuity between the data link connector terminals.

Data link connector		Continuity
Connector No.	Terminal No.	
M22	6	Not existed
	14	

Is the inspection result normal?

YES >> GO TO 3.

NO >> Check the harness and repair the root cause.

3. CHECK HARNESS CONTINUITY (SHORT CIRCUIT)

Check the continuity between the data link connector and the ground.

Data link connector		Ground	Continuity
Connector No.	Terminal No.		
M22	6	Ground	Not existed
	14		Not existed

Is the inspection result normal?

YES >> GO TO 4.

NO >> Check the harness and repair the root cause.

4. CHECK ECM AND IPDM E/R TERMINATION CIRCUIT

1. Remove the ECM and the IPDM E/R.
2. Check the resistance between the ECM terminals.

ECM		Resistance (Ω)
Terminal No.		
98	97	Approx. 108 – 132

3. Check the resistance between the IPDM E/R terminals.

IPDM E/R		Resistance (Ω)
Terminal No.		
40	39	Approx. 108 – 132

Is the measurement value within the specification?

YES >> GO TO 5.

NO >> Replace the ECM and/or the IPDM E/R.

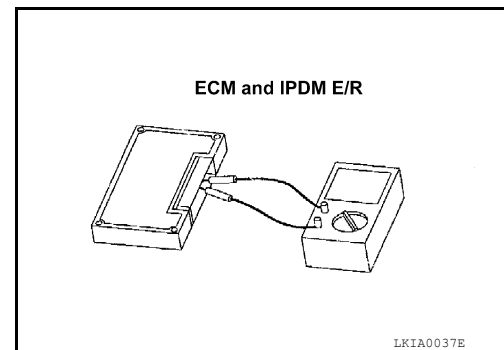

A
B
C
D
E
F
G
H
I
J
K
L
N
O
P

LAN

CAN COMMUNICATION CIRCUIT

< DTC/CIRCUIT DIAGNOSIS >

[CAN SYSTEM (TYPE 6)]

5.CHECK SYMPTOM

Connect all the connectors. Check if the symptoms described in the “Symptom (Results from interview with customer)” are reproduced.

Inspection result

Reproduced>>GO TO 6.

Non-reproduced>>Start the diagnosis again. Follow the trouble diagnosis procedure when past error is detected.

6.CHECK UNIT REPRODUCTION

Perform the reproduction test as per the following procedure for each unit.

1. Turn the ignition switch OFF.
2. Disconnect the battery cable from the negative terminal.
3. Disconnect one of the unit connectors of CAN communication system.

NOTE:

ECM and IPDM E/R have a termination circuit. Check other units first.

4. Connect the battery cable to the negative terminal. Check if the symptoms described in the “Symptom (Results from interview with customer)” are reproduced.

NOTE:

Although unit-related error symptoms occur, do not confuse them with other symptoms.

Inspection result

Reproduced>>Connect the connector. Check other units as per the above procedure.

Non-reproduced>>Replace the unit whose connector was disconnected.