

SECTION **DEF**  
**DEFOGGER**

A  
B  
C  
D  
E  
F  
G  
H  
I  
J  
K  
DEF  
M  
N  
O  
P

CONTENTS

<b>BASIC INSPECTION</b> .....	3	<b>DRIVER SIDE DOOR MIRROR DEFOGGER</b> ...	17
<b>DIAGNOSIS AND REPAIR WORKFLOW</b> .....	3	Description .....	17
Work Flow .....	3	Component Function Check .....	17
<b>SYSTEM DESCRIPTION</b> .....	6	Diagnosis Procedure .....	17
<b>REAR WINDOW DEFOGGER SYSTEM</b> .....	6	Component Inspection .....	18
System Diagram .....	6	<b>PASSENGER SIDE DOOR MIRROR DEFOGGER</b> .....	19
System Description .....	6	Description .....	19
Component Parts Location .....	7	Component Function Check .....	19
Component Description .....	7	Diagnosis Procedure .....	19
<b>DIAGNOSIS SYSTEM (BCM)</b> .....	9	Component Inspection .....	20
<b>COMMON ITEM</b> .....	9	<b>ECU DIAGNOSIS INFORMATION</b> .....	21
COMMON ITEM : CONSULT Function (BCM -		<b>BCM (BODY CONTROL MODULE)</b> .....	21
COMMON ITEM) .....	9	Reference Value .....	21
<b>REAR WINDOW DEFOGGER</b> .....	9	Terminal Layout .....	26
REAR WINDOW DEFOGGER : CONSULT Func-		Physical Values .....	26
tion (BCM - REAR DEFOGGER) .....	10	Fail Safe .....	42
<b>DTC/CIRCUIT DIAGNOSIS</b> .....	11	DTC Inspection Priority Chart .....	43
<b>REAR WINDOW DEFOGGER SWITCH</b> .....	11	DTC Index .....	44
Description .....	11	<b>WIRING DIAGRAM</b> .....	47
Component Function Check .....	11	<b>REAR WINDOW DEFOGGER</b> .....	47
Diagnosis Procedure .....	11	Wiring Diagram .....	47
<b>REAR WINDOW DEFOGGER RELAY</b> .....	13	<b>SYMPTOM DIAGNOSIS</b> .....	56
Description .....	13	<b>REAR WINDOW DEFOGGER AND DOOR</b>	
Component Function Check .....	13	<b>MIRROR DEFOGGER DO NOT OPERATE.</b> ....	56
Diagnosis Procedure .....	13	Diagnosis Procedure .....	56
Component Inspection .....	14	<b>REAR WINDOW DEFOGGER DOES NOT</b>	
<b>REAR WINDOW DEFOGGER POWER SUPPLY</b>		<b>OPERATE BUT BOTH OF DOOR MIRROR</b>	
<b>AND GROUND CIRCUIT</b> .....	15	<b>DEFOGGER OPERATE.</b> .....	58
Description .....	15	Diagnosis Procedure .....	58
Component Function Check .....	15	<b>BOTH DOORS MIRROR DEFOGGER DON'T</b>	
Diagnosis Procedure .....	15	<b>OPERATE BUT REAR WINDOW DEFOGGER</b>	
Component Inspection .....	16	<b>OPERATES</b> .....	59

Diagnosis Procedure .....	59	Precaution for Supplemental Restraint System (SRS) "AIR BAG" and "SEAT BELT PRE-TENSIONER" .....	63
<b>DRIVER SIDE DOOR MIRROR DEFOGGER DOES NOT OPERATE.</b> .....	<b>60</b>	Precaution for Work .....	63
Diagnosis Procedure .....	60	<b>PREPARATION</b> .....	<b>64</b>
<b>PASSENGER SIDE DOOR MIRROR DEFOGGER DOES NOT OPERATE.</b> .....	<b>61</b>	<b>PREPARATION</b> .....	<b>64</b>
Diagnosis Procedure .....	61	Special Service Tool .....	64
<b>REAR WINDOW DEFOGGER SWITCH DOES NOT LIGHT, BUT REAR WINDOW DEFOGGER OPERATES</b> .....	<b>62</b>	Commercial Service Tool .....	64
Diagnosis Procedure .....	62	<b>REMOVAL AND INSTALLATION</b> .....	<b>65</b>
<b>PRECAUTION</b> .....	<b>63</b>	<b>FILAMENT</b> .....	<b>65</b>
<b>PRECAUTIONS</b> .....	<b>63</b>	Inspection and Repair .....	65
		<b>CONDENSER</b> .....	<b>67</b>
		Removal and Installation .....	67

# DIAGNOSIS AND REPAIR WORKFLOW

< BASIC INSPECTION >

## BASIC INSPECTION

### DIAGNOSIS AND REPAIR WORKFLOW

Work Flow

INFOID:000000007252885

OVERALL SEQUENCE

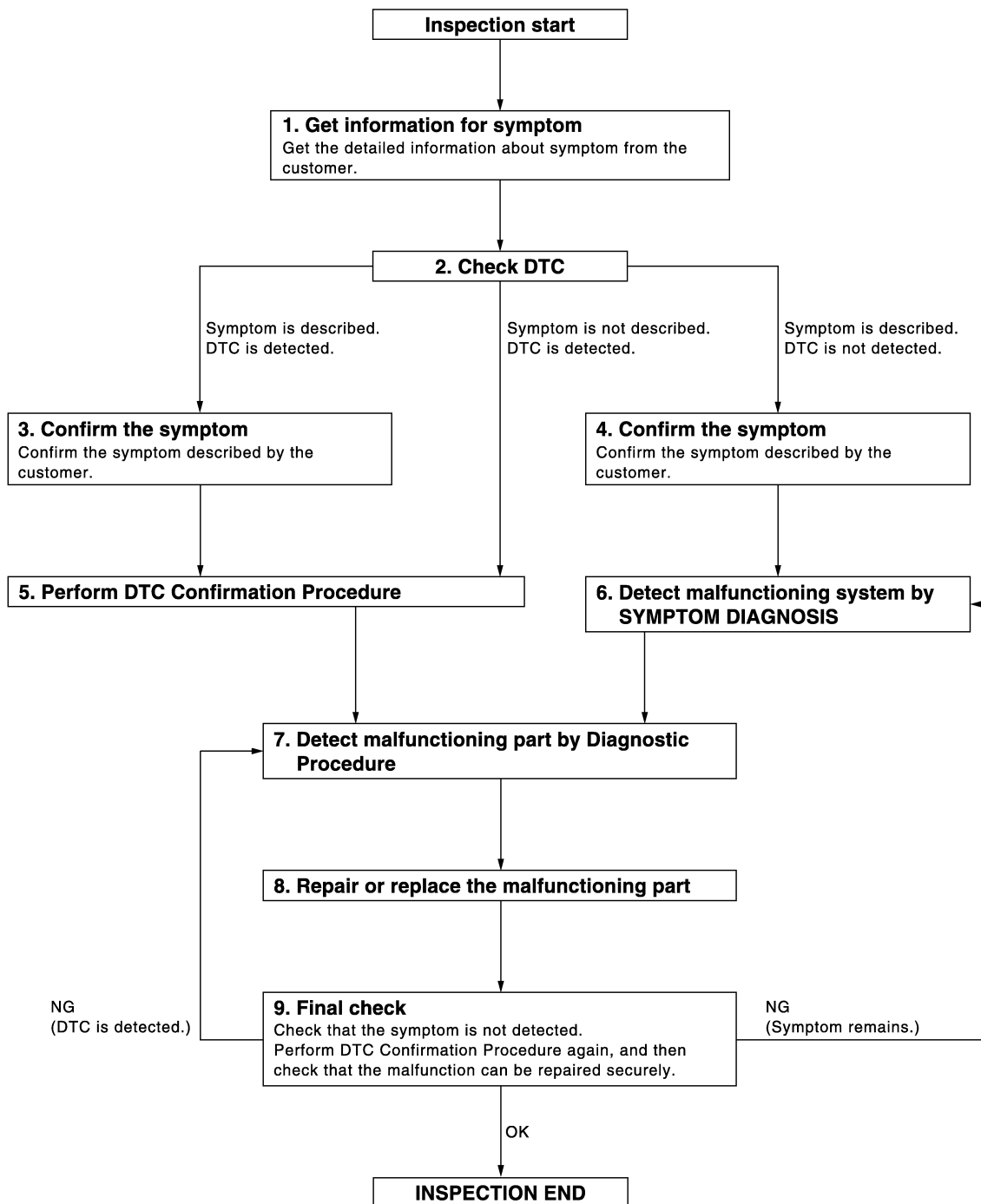

DETAILED FLOW

Revision: August 2012

DEF-3

JMKIA2270GB

2012 Maxima

# DIAGNOSIS AND REPAIR WORKFLOW

< BASIC INSPECTION >

---

## 1. GET INFORMATION FOR SYMPTOM

---

Get the detailed information from the customer about the symptom (the condition and the environment when the incident/malfunction occurred).

>> GO TO 2

## 2. CHECK DTC

---

1. Check DTC.
2. Perform the following procedure if DTC is displayed.
  - Record DTC and freeze frame data (Print them out with CONSULT.)
  - Erase DTC.
  - Study the relationship between the cause detected by DTC and the symptom described by the customer.
3. Check related service bulletins for information.

Is any symptom described and any DTC detected?

Symptom is described, DTC is displayed>>GO TO 3

Symptom is described, DTC is not displayed>>GO TO 4

Symptom is not described, DTC is displayed>>GO TO 5

## 3. CONFIRM THE SYMPTOM

---

Confirm the symptom described by the customer.

Connect CONSULT to the vehicle in "DATA MONITOR" mode and check real time diagnosis results.

Verify relation between the symptom and the condition when the symptom is detected.

>> GO TO 5

## 4. CONFIRM THE SYMPTOM

---

Confirm the symptom described by the customer.

Connect CONSULT to the vehicle in "DATA MONITOR" mode and check real time diagnosis results.

Verify relation between the symptom and the condition when the symptom is detected.

>> GO TO 6

## 5. PERFORM DTC CONFIRMATION PROCEDURE

---

Perform DTC Confirmation Procedure for the displayed DTC, and then check that DTC is detected again.

At this time, always connect CONSULT to the vehicle, and check diagnostic results in real time.

If two or more DTCs are detected, refer to [BCS-64. "DTC Inspection Priority Chart"](#) and determine trouble diagnosis order.

### NOTE:

- Freeze frame data is useful if the DTC is not detected.
- Perform Component Function Check if DTC Confirmation Procedure is not included in Service Manual. This simplified check procedure is an effective alternative though DTC cannot be detected during this check. If the result of Component Function Check is NG, it is the same as the detection of DTC by DTC Confirmation Procedure.

Is DTC detected?

YES >> GO TO 7

NO >> Refer to [GI-39. "Intermittent Incident"](#).

## 6. DETECT MALFUNCTIONING SYSTEM BY SYMPTOM TABLE

---

Detect malfunctioning system according to [DEF-6. "System Description"](#) based on the confirmed symptom in step 4, and determine the trouble diagnosis order based on possible causes and symptom.

>> GO TO 7

## 7. DETECT MALFUNCTIONING PART BY DIAGNOSTIC PROCEDURE

---

Inspect according to Diagnostic Procedure of the system.

### NOTE:

# DIAGNOSIS AND REPAIR WORKFLOW

## < BASIC INSPECTION >

The Diagnostic Procedure described is based on open circuit inspection. A short circuit inspection is also required for the circuit check in the Diagnostic Procedure.

### Is malfunctioning part detected?

YES >> GO TO 8

NO >> Check voltage of related BCM terminals using CONSULT.

## 8. REPAIR OR REPLACE THE MALFUNCTIONING PART

1. Repair or replace the malfunctioning part.
2. Reconnect parts or connectors disconnected during Diagnostic Procedure again after repair and replacement.
3. Check DTC. If DTC is displayed, erase it.

>> GO TO 9

## 9. FINAL CHECK

When DTC was detected in step 2, perform DTC Confirmation Procedure or Component Function Check again, and then check that the malfunction has been repaired securely.

When symptom was described from the customer, refer to confirmed symptom in step 3 or 4, and check that the symptom is not detected.

### Does the symptom reappear?

YES (DTC is detected)>>GO TO 7

YES (Symptom remains)>>GO TO 6

NO >> Inspection End.

A  
B  
C  
D  
E  
F  
G  
H  
I  
J  
K  
DEF  
M  
N  
O  
P

# REAR WINDOW DEFOGGER SYSTEM

< SYSTEM DESCRIPTION >

## SYSTEM DESCRIPTION

### REAR WINDOW DEFOGGER SYSTEM

#### System Diagram

INFOID:000000007252886

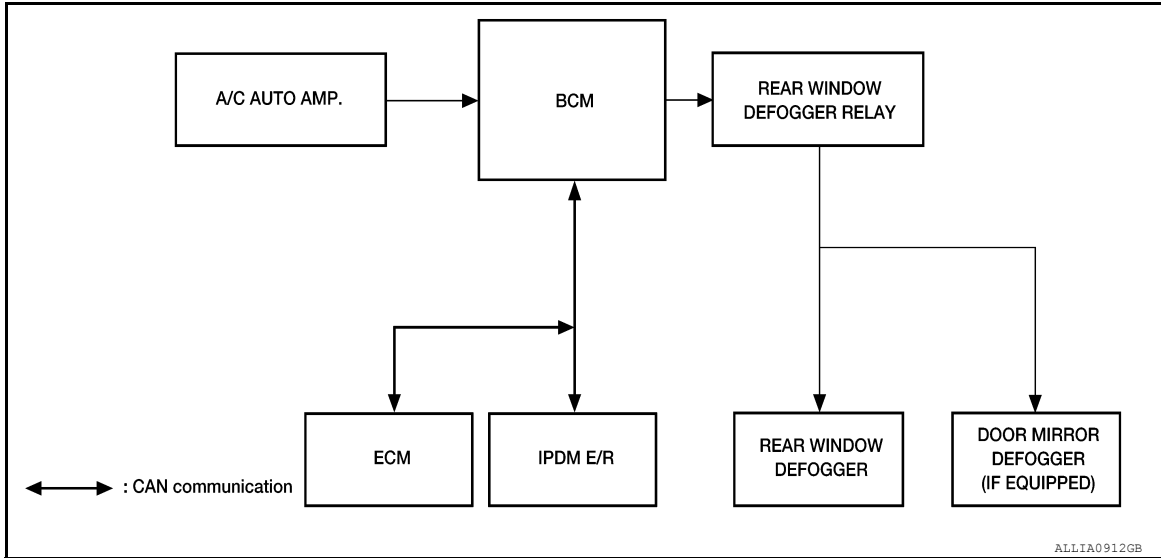

#### System Description

INFOID:000000007252887

#### Operation Description

- When rear window defogger switch is turned ON while ignition switch is ON, the A/C auto amp. (rear window defogger switch) transmits rear window defogger switch signal to BCM.
- BCM turns rear window defogger relay ON when rear window defogger switch signal is received.
- Rear window defogger and door mirror defogger (with door mirror defogger) are supplied with power and operate when rear window defogger relay turns ON.
- BCM transmits rear window defogger control signal to IPDM E/R via CAN communication when rear window defogger operates.
- Rear window defogger ON is displayed when controller (A/C auto amp.) receives signals.

#### Timer function

- BCM turns rear window defogger relay ON for approximately 15 minutes when rear window defogger switch is turned ON while ignition switch is ON. It makes rear window defogger and door mirror defogger (with door mirror defogger) operate.
- Timer is canceled after pressing rear window defogger switch again during timer operation. Then BCM turns rear window defogger relay OFF. The same reaction also occurs during timer operation, if the ignition switch is turned OFF.

#### INPUT/OUTPUT SIGNAL CHART

Switch	Input signal to BCM	BCM function	Actuator
Rear window defogger switch	Defogger switch signal	Rear window defogger and door mirror defogger* control	Rear window defogger
Push button ignition switch	Ignition signal		Door mirror defogger*

\*: With door mirror defogger

# REAR WINDOW DEFOGGER SYSTEM

< SYSTEM DESCRIPTION >

## Component Parts Location

INFOID:000000007252888

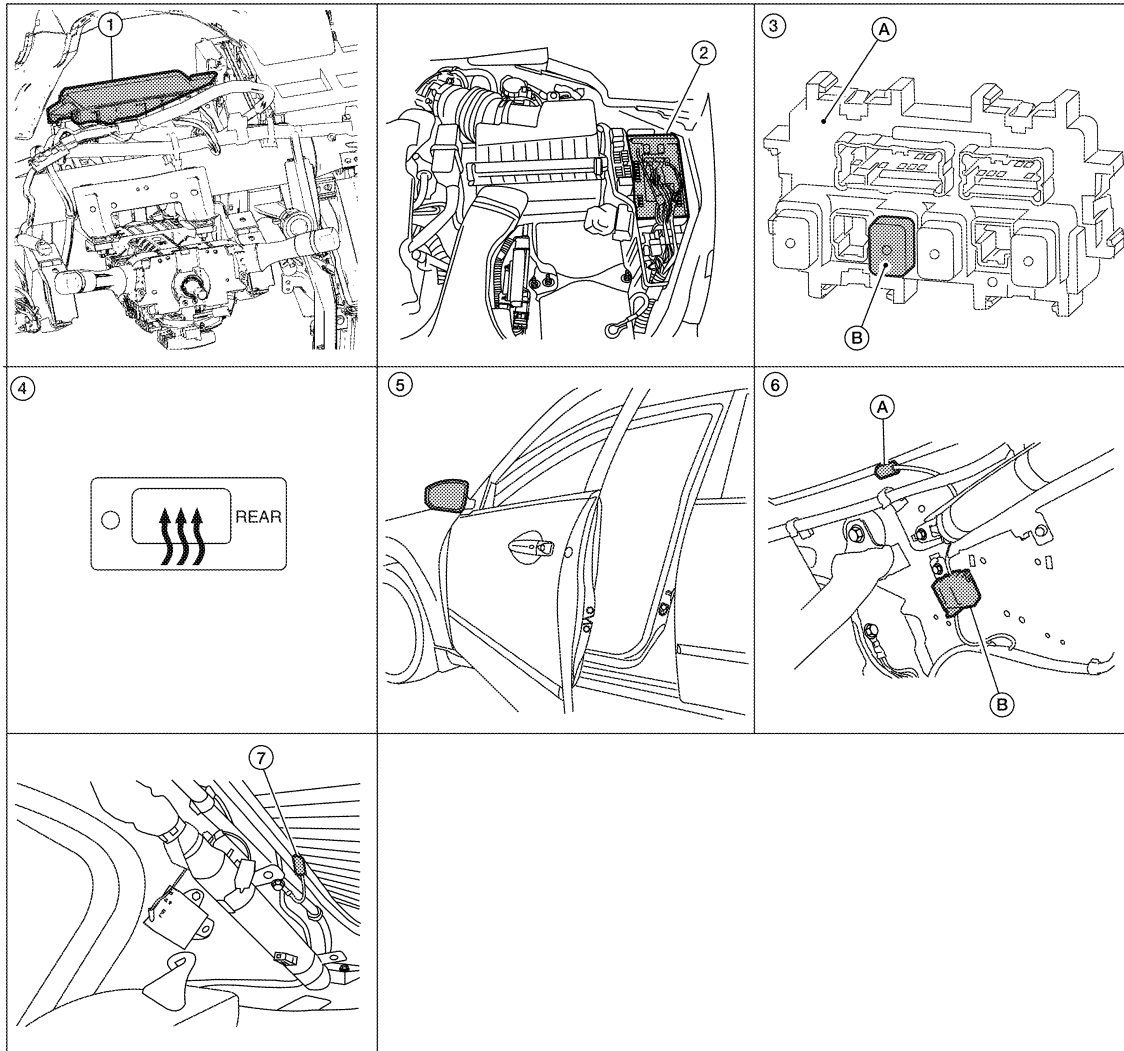

A  
B  
C  
D  
E  
F  
G  
H  
I  
J  
K

ALLIA091122

- |  |  |  |
|--|--|--|
| <p>1. BCM M16, M17, M18, M19 (view with instrument panel removed)</p> <p>4. A/C auto amp. (rear window defogger switch) M37</p> <p>7. Rear window defogger B54 (view with rear pillar finisher RH removed)</p> | <p>2. IPDM E/R E17</p> <p>5. Door mirror (door mirror defogger) LH D4, RH D107 (if equipped)</p> | <p>3. A. Fuse block (J/B)<br/>B. Rear window defogger relay J-2</p> <p>6. A. Rear window defogger B53<br/>B. Condenser B52 (view with rear pillar finisher LH removed)</p> |
|--|--|--|

DEF

M  
N

## Component Description

INFOID:000000007252889

BCM	<ul style="list-style-type: none"> <li>Operates the rear window defogger with the operation of rear window defogger switch.</li> <li>Performs the timer control of rear window defogger.</li> </ul>
Rear window defogger relay	<ul style="list-style-type: none"> <li>Operates the rear window defogger and the door mirror defogger with the control signal from BCM.</li> </ul>
A/C auto amp. (rear window defogger switch)	<ul style="list-style-type: none"> <li>The rear window defogger switch is turned ON.</li> <li>Turns the indicator lamp ON when detecting the operation of rear window defogger.</li> </ul>

O  
P

## REAR WINDOW DEFOGGER SYSTEM

### < SYSTEM DESCRIPTION >

Rear window defogger	<ul style="list-style-type: none"><li>• Heats the heating wire with the power supply from the rear window defogger relay to prevent the rear window from fogging up.</li></ul>
Door mirror defogger*	<ul style="list-style-type: none"><li>• Heats the heating wire with the power supply from the rear window defogger relay to prevent the door mirror from fogging up.</li></ul>

\*: With heated mirrors



# DIAGNOSIS SYSTEM (BCM)

< SYSTEM DESCRIPTION >

## DIAGNOSIS SYSTEM (BCM)

### COMMON ITEM

COMMON ITEM : CONSULT Function (BCM - COMMON ITEM)

INFOID:000000007806811

### APPLICATION ITEM

CONSULT performs the following functions via CAN communication with BCM.

Direct Diagnostic Mode	Description
Ecu Identification	The BCM part number is displayed.
Self Diagnostic Result	Displays the diagnosis results judged by BCM.
Data Monitor	The BCM input/output signals are displayed.
Active Test	The signals used to activate each device are forcibly supplied from BCM.
Work support	Changes the setting for each system function.
Configuration	<ul style="list-style-type: none"> <li>Enables to read and save the vehicle specification.</li> <li>Enables to write the vehicle specification when replacing BCM.</li> </ul>
CAN Diag Support Mntr	Monitors the reception status of CAN communication viewed from BCM.

### SYSTEM APPLICATION

BCM can perform the following functions.

System	Sub System	Direct Diagnostic Mode						
		Ecu Identification	Self Diagnostic Result	Data Monitor	Active Test	Work support	Configuration	CAN Diag Support Mntr
Door lock	DOOR LOCK		×	×	×	×		
Rear window defogger	REAR DEFOGGER			×	×			
Warning chime	BUZZER			×	×			
Interior room lamp timer	INT LAMP			×	×	×		
Exterior lamp	HEADLAMP			×	×	×		
Wiper and washer	WIPER			×	×	×		
Turn signal and hazard warning lamps	FLASHER			×	×	×		
Intelligent Key system	INTELLIGENT KEY			×	×	×		
Combination switch	COMB SW			×				
BCM	BCM	×	×			×	×	×
Immobilizer	IMMU		×	×	×			
Interior room lamp battery saver	BATTERY SAVER			×	×	×		
Trunk open	TRUNK			×	×			
Vehicle security system	THEFT ALM			×	×	×		
RAP system	RETAINED PWR			×				
Signal buffer system	SIGNAL BUFFER			×	×			
TPMS	AIR PRESSURE MONITOR		×	×	×	×		

### REAR WINDOW DEFOGGER

# DIAGNOSIS SYSTEM (BCM)

< SYSTEM DESCRIPTION >

## REAR WINDOW DEFOGGER : CONSULT Function (BCM - REAR DEFOGGER)

INFOID:000000007806812

### DATA MONITOR

Monitor Item [Unit]	Description
PUSH SW [On/Off]	Indicates condition of push button ignition switch
REAR DEF SW [On/Off]	Indicates condition of rear window defogger switch

### ACTIVE TEST

Test Item	Description
REAR DEFOGGER	This test is able to check rear window defogger operation [Off/On].

# REAR WINDOW DEFOGGER SWITCH

< DTC/CIRCUIT DIAGNOSIS >

## DTC/CIRCUIT DIAGNOSIS

### REAR WINDOW DEFOGGER SWITCH

#### Description

INFOID:000000007252892

- The rear window defogger is operated by turning the rear window defogger switch ON.
- Turns the indicator lamp in the rear window defogger switch ON when operating the rear window defogger.

#### Component Function Check

INFOID:000000007252893

#### 1. CHECK REAR WINDOW DEFOGGER SWITCH FUNCTION

Check that the indicator lamp of rear window defogger illuminates with rear window defogger switch ON.

Is the inspection result normal?

- YES >> Rear window defogger switch function is OK.  
NO >> Refer to [DEF-11, "Diagnosis Procedure"](#).

#### Diagnosis Procedure

INFOID:000000007252894

Regarding Wiring Diagram information, refer to [DEF-47, "Wiring Diagram"](#).

#### 1. CHECK A/C AUTO AMP. (REAR WINDOW DEFOGGER SWITCH)

Check A/C auto amp. operation.

Is the inspection result normal?

- YES >> Inspection End.  
NO >> GO TO 2

#### 2. CHECK REAR WINDOW DEFOGGER SWITCH REQUIRE SIGNAL

1. Turn ignition switch ON.
2. Check voltage between A/C auto amp. harness connector M37 terminal 27 and ground.

Terminals		Condition of rear window defogger switch	Voltage (V) (Approx.)
(+)	(-)		
A/C auto amp. connector	Terminal		
M37	27	ON	0
		OFF	5

Is the inspection result normal?

- YES >> GO TO 3  
NO >> GO TO 4

#### 3. CHECK REAR WINDOW DEFOGGER SWITCH REQUIRE SIGNAL CIRCUIT FOR OPEN

1. Turn ignition switch OFF.
2. Disconnect A/C auto amp harness connector M37.
3. Disconnect BCM harness connector M18.
4. Check continuity between A/C auto amp harness connector M37 terminal 27 and BCM harness connector M18 terminal 38.

BCM connector	Terminal	A/C auto amp. connector	Terminal	Continuity
M18	38	M37	27	Yes

Is the inspection result normal?

- YES >> Replace BCM. Refer to [BCS-80, "Removal and Installation"](#).

A  
B  
C  
D  
E  
F  
G  
H  
I  
J  
K  
M  
N  
O  
P

DEF

## REAR WINDOW DEFOGGER SWITCH

### < DTC/CIRCUIT DIAGNOSIS >

---

NO >> Repair and replace harness.

#### 4. CHECK REAR WINDOW DEFOGGER SWITCH REQUIRE SIGNAL CIRCUIT FOR SHORT

---

1. Turn ignition switch OFF.
2. Disconnect BCM harness connector M18.
3. Disconnect A/C auto amp harness connector M37.
4. Check continuity between BCM harness connector M18 terminal 38 and ground.

BCM connector	Terminal	Ground	Continuity
M18	38		No

#### Is the inspection result normal?

- YES >> Replace A/C auto amp. Refer to [HAC-211, "Removal and Installation"](#).
- NO >> Repair or replace harness.

# REAR WINDOW DEFOGGER RELAY

< DTC/CIRCUIT DIAGNOSIS >

## REAR WINDOW DEFOGGER RELAY

### Description

INFOID:000000007252895

Power is supplied to the rear window defogger with BCM control.

### Component Function Check

INFOID:000000007252896

#### 1. CHECK REAR WINDOW DEFOGGER RELAY POWER SUPPLY CIRCUIT

Check that an operation noise of rear window defogger relay [located in fuse block (J/B)] can be heard when turning the rear window defogger switch ON.

Is the inspection result normal?

- YES >> Rear window defogger relay power supply circuit is OK.
- NO >> Refer to [DEF-13, "Diagnosis Procedure"](#).

### Diagnosis Procedure

INFOID:000000007252897

Regarding Wiring Diagram information, refer to [DEF-47, "Wiring Diagram"](#).

#### 1. CHECK REAR WINDOW DEFOGGER RELAY GROUND CIRCUIT

1. Turn ignition switch ON.
2. Check voltage between BCM harness connector M18 terminal 59 and ground.

Terminals		Condition of rear window defogger switch	Voltage (V) (Approx.)
(+)	(-)		
BCM connector	Terminal		
M18	59	ON	0
		OFF	Battery voltage

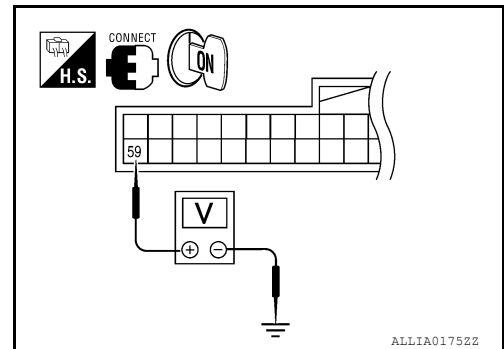

Is the inspection result normal?

- YES >> Rear window defogger relay power supply circuit is OK.
- NO >> GO TO 2

#### 2. CHECK HARNESS CONTINUITY

1. Turn ignition switch OFF.
2. Disconnect BCM and fuse block (J/B).
3. Check continuity between BCM harness connector M18 (A) terminal 59 and fuse block (J/B) harness connector M4 (B) terminal 4Q.

BCM connector	Terminal	Fuse block (J/B) connector	Terminal	Continuity
M18 (A)	59	M4 (B)	4Q	Yes

4. Check continuity between BCM harness connector M18 (A) terminal 59 and ground.

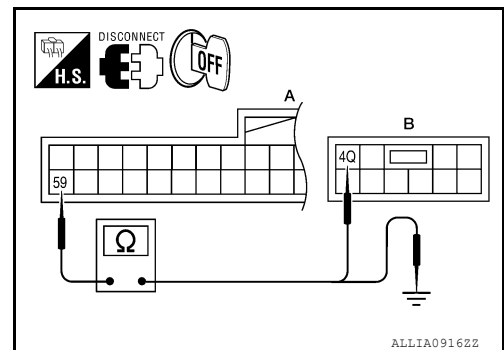

BCM connector	Terminal	Ground	Continuity
M18 (A)	59		No

Is the inspection result normal?

- YES >> GO TO 3
- NO >> Repair or replace harness.

# REAR WINDOW DEFOGGER RELAY

< DTC/CIRCUIT DIAGNOSIS >

## 3. CHECK REAR WINDOW DEFOGGER RELAY

Check rear window defogger relay.  
Refer to [DEF-14, "Component Inspection"](#).

Is the inspection result normal?

- YES >> GO TO 4
- NO >> Replace rear window defogger relay.

## 4. CHECK INTERMITTENT INCIDENT

Check intermittent incident.  
Refer to [GI-39, "Intermittent Incident"](#).

Is the inspection result normal?

- YES >> Check the following.
  - Battery power supply circuit.
  - Fuse block (J/B).
- NO >> Repair or replace the malfunctioning parts.

## Component Inspection

INFOID:000000007252898

## 1. CHECK REAR WINDOW DEFOGGER RELAY

Check rear window defogger relay.

Terminal		Condition	Continuity
Rear window defogger relay			
3	5	12V direct current supply between terminals 1 and 2.	Yes
		No current supply	No

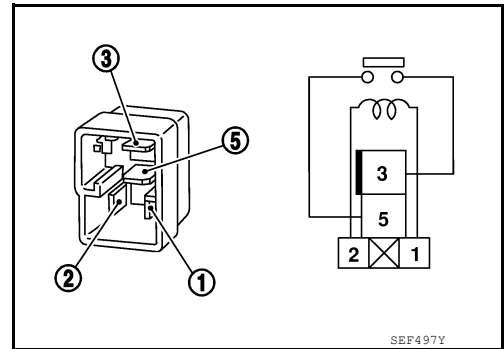

SEP497Y

Is the inspection result normal?

- YES >> Inspection End.
- NO >> Replace rear window defogger relay.

# REAR WINDOW DEFOGGER POWER SUPPLY AND GROUND CIRCUIT

< DTC/CIRCUIT DIAGNOSIS >

## REAR WINDOW DEFOGGER POWER SUPPLY AND GROUND CIRCUIT

### Description

INFOID:000000007252899

Heats the heating wire with the power supply from the rear window defogger relay to prevent the rear window from fogging up.

### Component Function Check

INFOID:000000007252900

### 1. CHECK REAR WINDOW DEFOGGER

Check that the heating wire of rear window defogger is heated when turning the rear window defogger switch ON.

Is the inspection result normal?

- YES >> Rear window defogger is OK.
- NO >> Refer to [DEF-15, "Diagnosis Procedure"](#).

### Diagnosis Procedure

INFOID:000000007252901

Regarding Wiring Diagram information, refer to [DEF-47, "Wiring Diagram"](#).

### 1. CHECK POWER SUPPLY CIRCUIT

1. Turn ignition switch ON.
2. Check voltage between rear window defogger harness connector B53 terminal 1 and ground.

Terminals			Condition of rear window defogger switch	Voltage (V) (Approx.)
(+)		(-)		
Rear window defogger connector	Terminal			
B53	1	Ground	ON	Battery voltage
			OFF	0

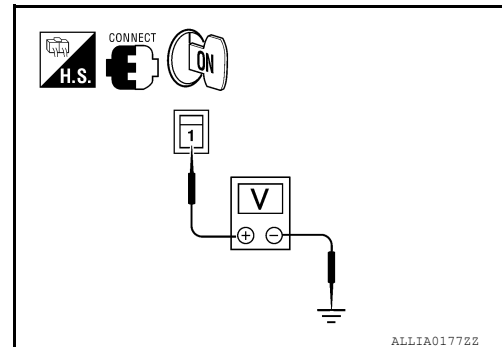

Is the inspection result normal?

- YES >> GO TO 2
- NO >> GO TO 3

### 2. CHECK GROUND CIRCUIT

1. Turn ignition switch OFF.
2. Disconnect rear window defogger.
3. Check continuity between rear window defogger harness connector B54 terminal 2 and ground.

Rear window defogger connector	Terminal	Ground	Continuity
B54	2		Yes

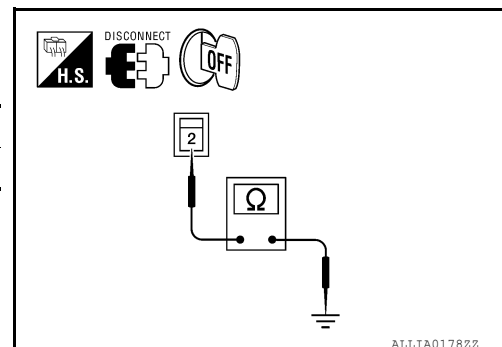

Is the inspection result normal?

- YES >> GO TO 5
- NO >> Repair or replace harness.

### 3. CHECK HARNESS CONTINUITY 1

1. Turn ignition switch OFF.

A  
B  
C  
D  
E  
F  
G  
H  
I  
J  
K  
DEF  
M  
N  
O  
P

# REAR WINDOW DEFOGGER POWER SUPPLY AND GROUND CIRCUIT

## < DTC/CIRCUIT DIAGNOSIS >

2. Disconnect condenser and rear window defogger.
3. Check continuity between condenser harness connector B52 (A) terminal 1 and rear window defogger harness connector B53 (B) terminal 1.

Condenser connector	Terminal	Rear window defogger connector	Terminal	Continuity
B52 (A)	1	B53 (B)	1	Yes

Is the inspection result normal?

- YES >> GO TO 4  
 NO >> Replace condenser. Refer to [DEF-67, "Removal and Installation"](#).

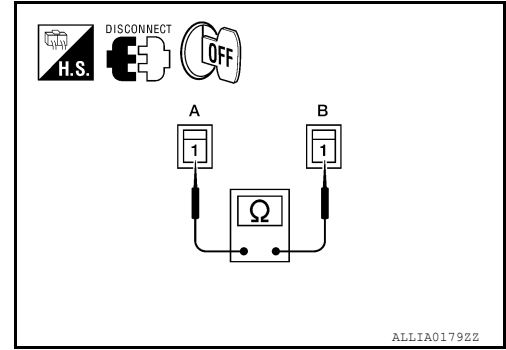

ALLIA01792Z

## 4. CHECK HARNESS CONTINUITY 2

1. Disconnect fuse block (J/B).
2. Check continuity between fuse block (J/B) harness connector B4 (A) terminal 10T, 11T and condenser harness connector B52 (B) terminal 1.

Fuse block (J/B) connector	Terminal	Condenser connector	Terminal	Continuity
B4 (A)	10T	B52 (B)	1	Yes
	11T			

Is the inspection result normal?

- YES >> GO TO 6  
 NO >> Replace or repair harness.

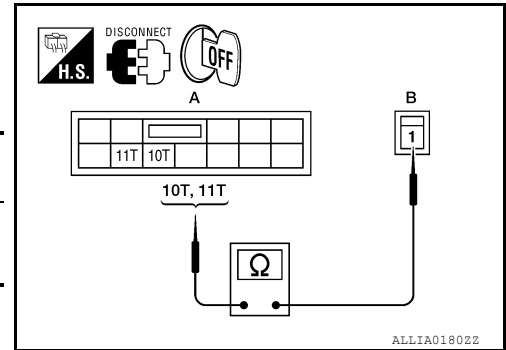

ALLIA01802Z

## 5. CHECK FILAMENT

Check filament.

Refer to [DEF-16, "Component Inspection"](#).

Is the inspection result normal?

- YES >> Refer to [GI-39, "Intermittent Incident"](#).  
 NO >> Repair filament. Refer to [DEF-65, "Inspection and Repair"](#).

## 6. CHECK INTERMITTENT INCIDENT

Check intermittent incident.

Refer to [GI-39, "Intermittent Incident"](#).

Is the inspection result normal?

- YES >> Check the following.
- Battery power supply circuit.
  - Fuse block (J/B).
- NO >> Repair or replace the malfunctioning parts.

## Component Inspection

INFOID:000000007252902

### 1. CHECK FILAMENT

Check the filament for damage or open circuits.

Refer to [DEF-65, "Inspection and Repair"](#).

Is the inspection result normal?

- YES >> Inspection End.  
 NO >> Repair filament. Refer to [DEF-65, "Inspection and Repair"](#).



# DRIVER SIDE DOOR MIRROR DEFOGGER

< DTC/CIRCUIT DIAGNOSIS >

## DRIVER SIDE DOOR MIRROR DEFOGGER

### Description

INFOID:000000007252903

Heats the heating wire with the power supply from the rear window defogger relay to prevent the door mirror from fogging up.

### Component Function Check

INFOID:000000007252904

#### 1. CHECK DOOR MIRROR DEFOGGER LH

Check that heating wire of door mirror defogger LH is heated when turning the rear window defogger switch ON.

Is the inspection result normal?

- YES >> Door mirror defogger is OK.
- NO >> Refer to [DEF-17, "Diagnosis Procedure"](#).

### Diagnosis Procedure

INFOID:000000007252905

Regarding Wiring Diagram information, refer to [DEF-47, "Wiring Diagram"](#).

#### 1. CHECK POWER SUPPLY CIRCUIT

1. Turn ignition switch OFF.
2. Disconnect door mirror LH.
3. Turn ignition switch ON.
4. Check voltage between door mirror LH harness connector D4 terminal 5 and ground.

Terminals		Condition of rear window defogger switch	Voltage (V) (Approx.)
(+)	(-)		
Door mirror LH connector	Terminal		
D4	5	ON	Battery voltage
		OFF	0

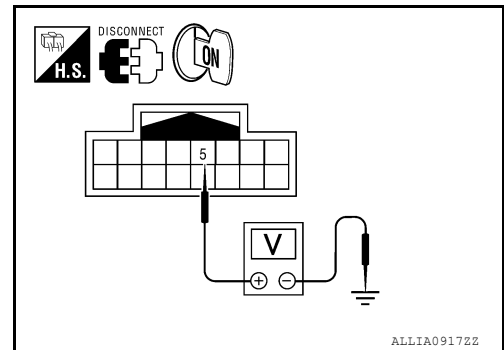

Is the inspection result normal?

- YES >> GO TO 2
- NO >> Repair or replace harness.

#### 2. CHECK GROUND CIRCUIT

1. Turn ignition switch OFF.
2. Check continuity between door mirror LH harness connector D4 terminal 13 and ground.

Door mirror LH connector	Terminal	Ground	Continuity
D4	13		Yes

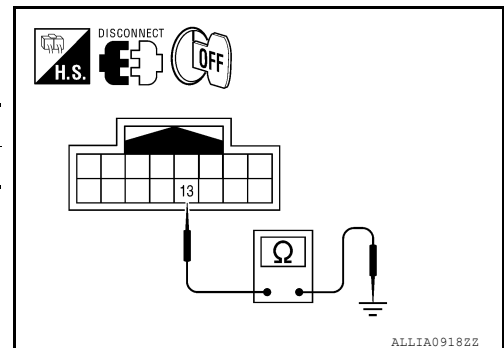

Is the inspection result normal?

- YES >> GO TO 3
- NO >> Repair or replace harness.

#### 3. CHECK DOOR MIRROR DEFOGGER LH

Check door mirror defogger LH.  
Refer to [DEF-18, "Component Inspection"](#).

A  
B  
C  
D  
E  
F  
G  
H  
I  
J  
K  
DEF  
M  
N  
O  
P

# DRIVER SIDE DOOR MIRROR DEFOGGER

## < DTC/CIRCUIT DIAGNOSIS >

### Is the inspection result normal?

YES >> GO TO 4

NO >> Replace door mirror. Refer to [MIR-19. "Removal and Installation"](#).

## 4. CHECK INTERMITTENT INCIDENT

Check intermittent incident.

Refer to [GI-39. "Intermittent Incident"](#).

### Is the inspection result normal?

YES >> Check the following.

- Battery power supply circuit.
- Fuse block (J/B).

NO >> Repair or replace the malfunctioning parts.

## Component Inspection

INFOID:000000007252906

## 1. CHECK DOOR MIRROR DEFOGGER LH

1. Turn ignition switch OFF.
2. Disconnect door mirror LH.
3. Check continuity between door mirror terminals 5 and 13.

Terminal		Continuity
5	13	Yes

### Is the inspection result normal?

YES >> Inspection End.

NO >> Replace door mirror LH. Refer to [MIR-19. "Removal and Installation"](#).

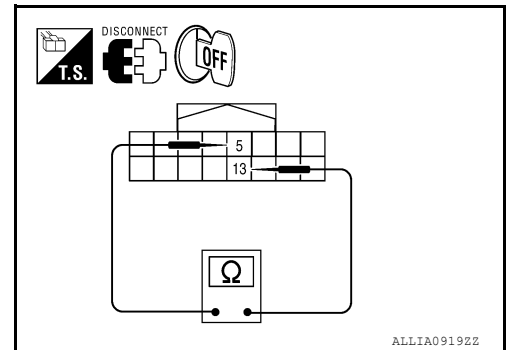

ALLIA0919ZZ

# PASSENGER SIDE DOOR MIRROR DEFOGGER

< DTC/CIRCUIT DIAGNOSIS >

## PASSENGER SIDE DOOR MIRROR DEFOGGER

### Description

INFOID:000000007252907

Heats the heating wire with the power supply from the rear window defogger relay to prevent the door mirror from fogging up.

### Component Function Check

INFOID:000000007252908

#### 1. CHECK DOOR MIRROR DEFOGGER RH

Check that the heating wire of door mirror defogger RH is heated when turning the rear window defogger switch ON.

Is the inspection result normal?

- YES >> Door mirror defogger RH is OK.
- NO >> Refer to [DEF-19. "Diagnosis Procedure"](#).

### Diagnosis Procedure

INFOID:000000007252909

Regarding Wiring Diagram information, refer to [DEF-47. "Wiring Diagram"](#).

#### 1. CHECK POWER SUPPLY CIRCUIT

1. Turn ignition switch OFF.
2. Disconnect door mirror RH.
3. Turn ignition switch ON.
4. Check voltage between door mirror RH harness connector D107 terminal 5 and ground.

Terminals		(-)	Condition of rear window defogger switch	Voltage (V) (Approx.)
(+)	Terminal			
Door mirror RH connector			ON	Battery voltage
D107	5	Ground	OFF	0

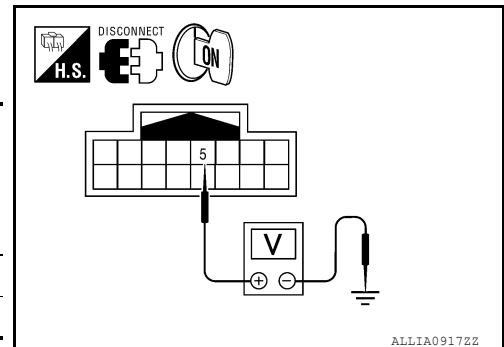

Is the inspection result normal?

- YES >> GO TO 2
- NO >> Repair or replace harness.

#### 2. CHECK GROUND CIRCUIT

1. Turn ignition switch OFF.
2. Check continuity between door mirror RH harness connector D107 terminal 13 and ground.

Door mirror RH connector	Terminal	Ground	Continuity
D107	13		Yes

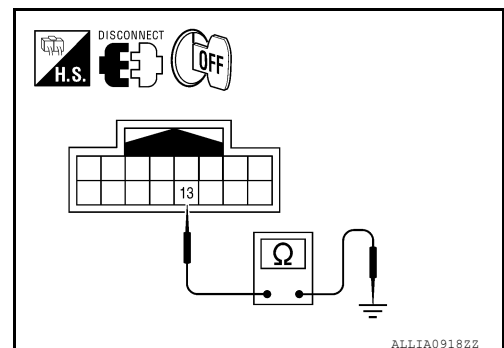

Is the inspection result normal?

- YES >> GO TO 3
- NO >> Repair or replace harness.

#### 3. CHECK PASSENGER SIDE DOOR MIRROR DEFOGGER

Check door mirror defogger RH.  
Refer to [DEF-20. "Component Inspection"](#).

A  
B  
C  
D  
E  
F  
G  
H  
I  
J  
K  
DEF  
M  
N  
O  
P

# PASSENGER SIDE DOOR MIRROR DEFOGGER

< DTC/CIRCUIT DIAGNOSIS >

Is the inspection result normal?

YES >> GO TO 4

NO >> Replace door mirror RH. Refer to [MIR-19, "Removal and Installation"](#).

## 4. CHECK INTERMITTENT INCIDENT

Check intermittent incident.

Refer to [GI-39, "Intermittent Incident"](#).

Is the inspection result normal?

YES >> Check the following.

- Battery power supply circuit.
- Fuse block (J/B).

NO >> Repair or replace the malfunctioning parts.

## Component Inspection

INFOID:000000007252910

### 1. CHECK DOOR MIRROR DEFOGGER RH

1. Turn ignition switch OFF.
2. Disconnect door mirror RH.
3. Check continuity between door mirror terminals 5 and 13.

Terminal		Continuity
5	13	Yes

Is the inspection result normal?

YES >> Inspection End.

NO >> Replace door mirror RH. Refer to [MIR-19, "Removal and Installation"](#).

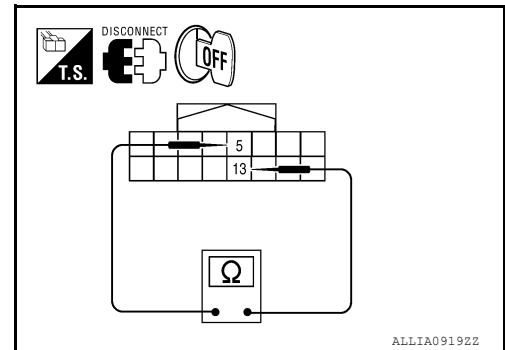

ALLIA09192Z

## BCM (BODY CONTROL MODULE)

< ECU DIAGNOSIS INFORMATION >

# ECU DIAGNOSIS INFORMATION

## BCM (BODY CONTROL MODULE)

### Reference Value

INFOID:000000007806818

#### NOTE:

The Signal Tech II Tool (J-50190) can be used to perform the following functions. Refer to the Signal Tech II User Guide for additional information.

- Activate and display TPMS transmitter IDs
- Display tire pressure reported by the TPMS transmitter
- Read TPMS DTCs
- Register TPMS transmitter IDs
- Check Intelligent Key relative signal strength
- Confirm vehicle Intelligent Key antenna signal strength

### VALUES ON THE DIAGNOSIS TOOL

Monitor Item	Condition	Value/Status
FR WIPER HI	Other than front wiper switch HI	OFF
	Front wiper switch HI	ON
FR WIPER LOW	Other than front wiper switch LO	OFF
	Front wiper switch LO	ON
FR WASHER SW	Front washer switch OFF	OFF
	Front washer switch ON	ON
FR WIPER INT	Other than front wiper switch INT	OFF
	Front wiper switch INT	ON
FR WIPER STOP	Front wiper is not in STOP position	OFF
	Front wiper is in STOP position	ON
INT VOLUME	Wiper intermittent dial is in a dial position 1 - 7	Wiper intermittent dial position
TURN SIGNAL R	Other than turn signal switch RH	OFF
	Turn signal switch RH	ON
TURN SIGNAL L	Other than turn signal switch LH	OFF
	Turn signal switch LH	ON
TAIL LAMP SW	Other than lighting switch 1ST and 2ND	OFF
	Lighting switch 1ST or 2ND	ON
HI BEAM SW	Other than lighting switch HI	OFF
	Lighting switch HI	ON
HEAD LAMP SW 1	Other than lighting switch 2ND	OFF
	Lighting switch 2ND	ON
HEAD LAMP SW 2	Other than lighting switch 2ND	OFF
	Lighting switch 2ND	ON
PASSING SW	Other than lighting switch PASS	OFF
	Lighting switch PASS	ON
AUTO LIGHT SW	Other than lighting switch AUTO	OFF
	Lighting switch AUTO	ON
FR FOG SW	Front fog lamp switch OFF	OFF
	Front fog lamp switch ON	ON
DOOR SW-DR	Driver door closed	OFF
	Driver door opened	ON

## BCM (BODY CONTROL MODULE)

### < ECU DIAGNOSIS INFORMATION >

Monitor Item	Condition	Value/Status
DOOR SW-AS	Passenger door closed	OFF
	Passenger door opened	ON
DOOR SW-RR	Rear door RH closed	OFF
	Rear door RH opened	ON
DOOR SW-RL	Rear door LH closed	OFF
	Rear door LH opened	ON
CDL LOCK SW	Other than power door lock switch LOCK	OFF
	Power door lock switch LOCK	ON
CDL UNLOCK SW	Other than power door lock switch UNLOCK	OFF
	Power door lock switch UNLOCK	ON
KEY CYL LK-SW	Other than driver door key cylinder LOCK position	OFF
	Driver door key cylinder LOCK position	ON
KEY CYL UN-SW	Other than driver door key cylinder UNLOCK position	OFF
	Driver door key cylinder UNLOCK position	ON
HAZARD SW	When hazard switch is not pressed	OFF
	When hazard switch is pressed	ON
REAR DEF SW	When rear window defogger switch is pressed	ON
TR CANCEL SW	Trunk lid opener cancel switch OFF	OFF
	Trunk lid opener cancel switch ON	ON
TR/BD OPEN SW	Trunk lid opener switch OFF	OFF
	While the trunk lid opener switch is turned ON	ON
TRNK/HAT MNTR	Trunk lid closed	OFF
	Trunk lid opened	ON
RKE-LOCK	When LOCK button of Intelligent Key is not pressed	OFF
	When LOCK button of Intelligent Key is pressed	ON
RKE-UNLOCK	When UNLOCK button of Intelligent Key is not pressed	OFF
	When UNLOCK button of Intelligent Key is pressed	ON
RKE-TR/BD	When TRUNK OPEN button of Intelligent Key is not pressed	OFF
	When TRUNK OPEN button of Intelligent Key is pressed	ON
RKE-PANIC	When PANIC button of Intelligent Key is not pressed	OFF
	When PANIC button of Intelligent Key is pressed	ON
RKE-P/W OPEN	When UNLOCK button of Intelligent Key is not pressed and held	OFF
	When UNLOCK button of Intelligent Key is pressed and held	ON
RKE-MODE CHG	When LOCK/UNLOCK button of Intelligent Key is not pressed and held simultaneously	OFF
	When LOCK/UNLOCK button of Intelligent Key is pressed and held simultaneously	ON
OPTICAL SENSOR	When outside of the vehicle is bright	Close to 5 V
	When outside of the vehicle is dark	Close to 0 V
REQ SW -DR	When front door request switch is not pressed (driver side)	OFF
	When front door request switch is pressed (driver side)	ON
REQ SW -AS	When front door request switch is not pressed (passenger side)	OFF
	When front door request switch is pressed (passenger side)	ON
REQ SW -RL	When rear door request switch is not pressed (driver side)	OFF
	When rear door request switch is pressed (driver side)	ON

## BCM (BODY CONTROL MODULE)

### < ECU DIAGNOSIS INFORMATION >

Monitor Item	Condition	Value/Status	
REQ SW -RR	When rear door request switch is not pressed (passenger side)	OFF	A
	When rear door request switch is pressed (passenger side)	ON	
REQ SW -BD/TR	When trunk request switch is not pressed	OFF	B
	When trunk request switch is pressed	ON	
PUSH SW	When engine switch (push switch) is not pressed	OFF	C
	When engine switch (push switch) is pressed	ON	
IGN RLY 2 -F/B	Ignition switch OFF or ACC	OFF	
	Ignition switch ON	ON	D
ACC RLY -F/B	Ignition switch OFF	OFF	
	Ignition switch ACC or ON	ON	
BRAKE SW 1	When the brake pedal is not depressed	ON	E
	When the brake pedal is depressed	OFF	
DETE/CANCL SW	When selector lever is in P position	OFF	F
	When selector lever is in any position other than P	ON	
SFT PN/N SW	When selector lever is in any position other than P or N	OFF	
	When selector lever is in P or N position	ON	G
UNLK SEN -DR	Driver door UNLOCK status	OFF	
	Driver door LOCK status	ON	
PUSH SW -IPDM	When engine switch (push switch) is not pressed	OFF	H
	When engine switch (push switch) is pressed	ON	
IGN RLY1 -F/B	Ignition switch OFF or ACC	OFF	I
	Ignition switch ON	ON	
DETE SW -IPDM	When selector lever is in P position	OFF	J
	When selector lever is in any position other than P	ON	
SFT PN -IPDM	When selector lever is in any position other than P or N	OFF	
	When selector lever is in P or N position	ON	K
SFT P -MET	When selector lever is in any position other than P	OFF	
	When selector lever is in P position	ON	
SFT N -MET	When selector lever is in any position other than N	OFF	DEF
	When selector lever is in N position	ON	
ENGINE STATE	Engine stopped	STOP	M
	While the engine stalls	STALL	
	At engine cranking	CRANK	
	Engine running	RUN	N
VEH SPEED 1	While driving	Equivalent to speedometer reading	
VEH SPEED 2	While driving	Equivalent to speedometer reading	
DOOR STAT-DR	Driver door LOCK status	LOCK	O
	Wait with selective UNLOCK operation (5 seconds)	READY	
	Driver door UNLOCK status	UNLK	P
DOOR STAT-AS	Passenger door LOCK status	LOCK	
	Wait with selective UNLOCK operation (5 seconds)	READY	
	Passenger door UNLOCK status	UNLK	
ID OK FLAG	Ignition switch ACC or ON	RESET	
	Ignition switch OFF	SET	

## BCM (BODY CONTROL MODULE)

### < ECU DIAGNOSIS INFORMATION >

Monitor Item	Condition	Value/Status
PRMT ENG STRT	When the engine start is prohibited	RESET
	When the engine start is permitted	SET
KEY SW -SLOT	When Intelligent Key is not inserted into key slot	OFF
	When Intelligent Key is inserted into key slot	ON
RKE OPE COUN1	During the operation of Intelligent Key	Operation frequency of Intelligent Key
CONFIRM ID ALL	The key ID that the key slot receives does not accord with any key ID registered to BCM.	YET
	The key ID that the key slot receives accords with any key ID registered to BCM.	DONE
CONFIRM ID4	The key ID that the key slot receives does not accord with the fourth key ID registered to BCM.	YET
	The key ID that the key slot receives accords with the fourth key ID registered to BCM.	DONE
CONFIRM ID3	The key ID that the key slot receives does not accord with the third key ID registered to BCM.	YET
	The key ID that the key slot receives accords with the third key ID registered to BCM.	DONE
CONFIRM ID2	The key ID that the key slot receives does not accord with the second key ID registered to BCM.	YET
	The key ID that the key slot receives accords with the second key ID registered to BCM.	DONE
CONFIRM ID1	The key ID that the key slot receives does not accord with the first key ID registered to BCM.	YET
	The key ID that the key slot receives accords with the first key ID registered to BCM.	DONE
TP 4	The ID of fourth key is not registered to BCM	YET
	The ID of fourth key is registered to BCM	DONE
TP 3	The ID of third key is not registered to BCM	YET
	The ID of third key is registered to BCM	DONE
TP 2	The ID of second key is not registered to BCM	YET
	The ID of second key is registered to BCM	DONE
TP 1	The ID of first key is not registered to BCM	YET
	The ID of first key is registered to BCM	DONE
AIR PRESS FL	Ignition switch ON (only when the signal from the transmitter is received)	Air pressure of front LH tire
AIR PRESS FR	Ignition switch ON (only when the signal from the transmitter is received)	Air pressure of front RH tire
AIR PRESS RR	Ignition switch ON (only when the signal from the transmitter is received)	Air pressure of rear RH tire
AIR PRESS RL	Ignition switch ON (only when the signal from the transmitter is received)	Air pressure of rear LH tire
ID REGST FL1	When ID of front LH tire transmitter is registered	DONE
	When ID of front LH tire transmitter is not registered	YET
ID REGST FR1	When ID of front RH tire transmitter is registered	DONE
	When ID of front RH tire transmitter is not registered	YET
ID REGST RR1	When ID of rear RH tire transmitter is registered	DONE
	When ID of rear RH tire transmitter is not registered	YET
ID REGST RL1	When ID of rear LH tire transmitter is registered	DONE
	When ID of rear LH tire transmitter is not registered	YET



# BCM (BODY CONTROL MODULE)

## < ECU DIAGNOSIS INFORMATION >

Monitor Item	Condition	Value/Status
WARNING LAMP	Tire pressure indicator OFF	OFF
	Tire pressure indicator ON	ON
BUZZER	Tire pressure warning alarm is not sounding	OFF
	Tire pressure warning alarm is sounding	ON

A

B

C

D

E

F

G

H

I

J

K

**DEF**

M

N

O

P

# BCM (BODY CONTROL MODULE)

< ECU DIAGNOSIS INFORMATION >

## Terminal Layout

INFOID:000000007806819

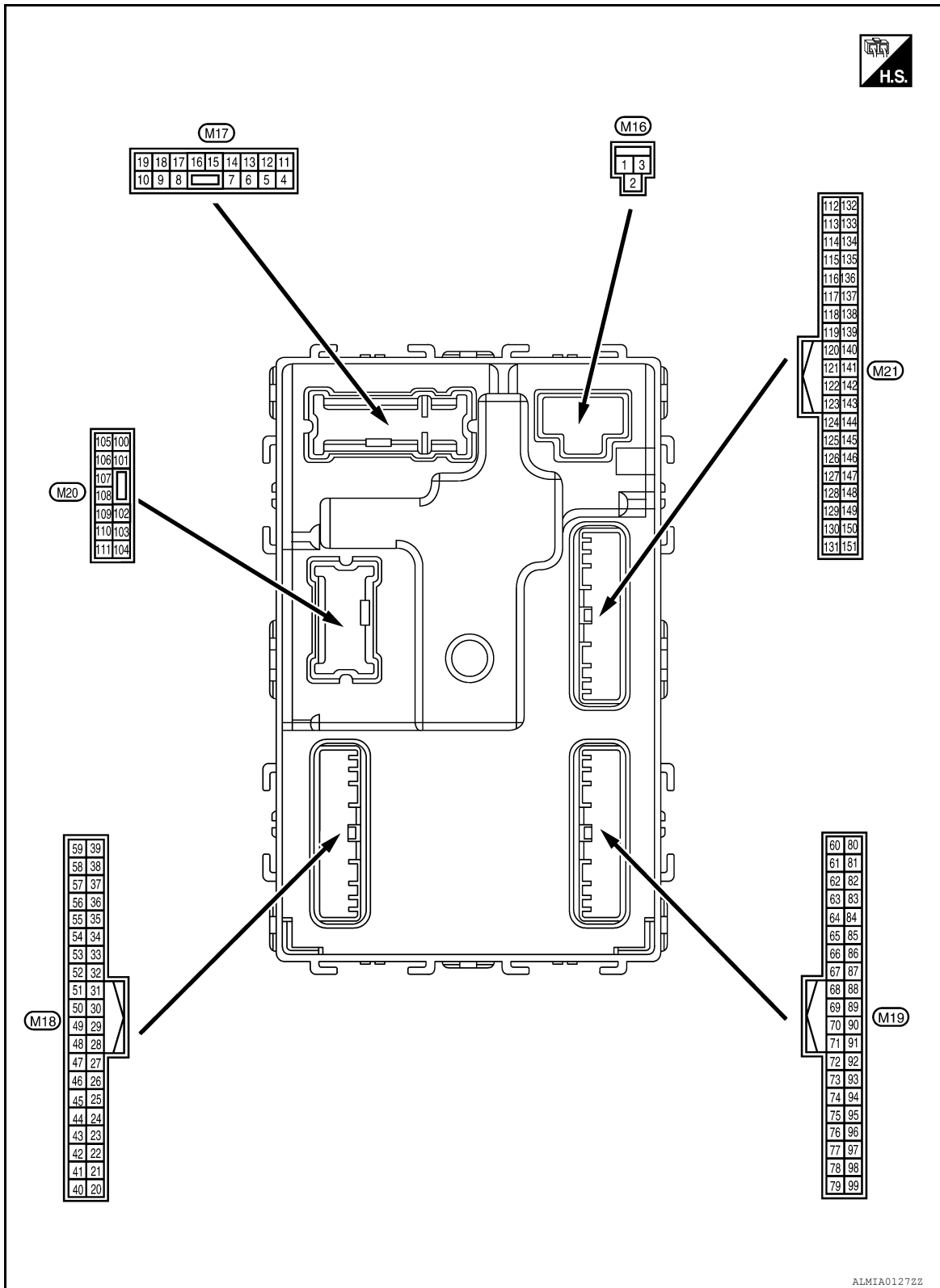

## Physical Values

INFOID:000000007806820

# BCM (BODY CONTROL MODULE)

## < ECU DIAGNOSIS INFORMATION >

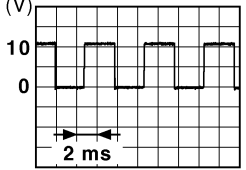
Terminal No. (Wire color)		Description		Condition		Value (Approx.)	
(+)	(-)						
1 (W/B)	Ground	Battery power supply	Input	Ignition switch OFF		Battery voltage	A
2 (R/Y)	Ground	Battery power supply output	Output	Ignition switch OFF		Battery voltage	B
3 (L/W)	Ground	Ignition power supply output	Output	Ignition switch ON		Battery voltage	C
4 (P/W)	Ground	Interior room lamp power supply	Output	After passing the interior room lamp battery saver operation time		0V	D
				Any other time after passing the interior room lamp battery saver operation time		Battery voltage	E
5 (G)	Ground	Front door RH UNLOCK	Output	Front door RH	UNLOCK (actuator is activated)	Battery voltage	F
					Other than UNLOCK (actuator is not activated)	0V	
7 (R/W)	Ground	Step lamp	Output	Step lamp	ON	0V	G
					OFF	Battery voltage	
8 (V)	Ground	All doors LOCK	Output	All doors	LOCK (actuator is activated)	Battery voltage	H
					Other than LOCK (actuator is not activated)	0V	
9 (L)	Ground	Front door LH UNLOCK	Output	Front door LH	UNLOCK (actuator is activated)	Battery voltage	I
					Other than UNLOCK (actuator is not activated)	0V	
10 (G)	Ground	Rear door RH and rear door LH UNLOCK	Output	Rear door RH and rear door LH	UNLOCK (actuator is activated)	Battery voltage	J
					Other than UNLOCK (actuator is not activated)	0V	
11 (Y/R)	Ground	Battery power supply	Input	Ignition switch OFF		Battery voltage	K
13 (B)	Ground	Ground	—	Ignition switch ON		0V	DEF
14 (GR/W)	Ground	Engine switch (push switch) illumination ground	Input	Tail lamp	OFF	0V	M
					ON	<b>NOTE:</b> When the illumination brightening/dimming level is in the neutral position  <p style="text-align: center;">(V)</p> <p style="text-align: center;">10 0</p> <p style="text-align: center;">2 ms</p> <p style="text-align: right; font-size: small;">JSNIA0010GB</p>	
15 (Y/L)	Ground	ACC indicator lamp	Output	Ignition switch	OFF	Battery voltage	O
					ACC or ON	0V	

# BCM (BODY CONTROL MODULE)

## < ECU DIAGNOSIS INFORMATION >

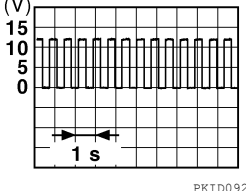
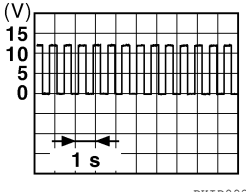
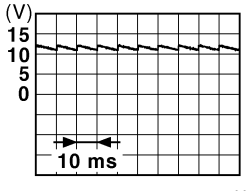
Terminal No. (Wire color)		Description		Condition		Value (Approx.)
(+)	(-)	Signal name	Input/ Output			
17 (G/B)	Ground	Turn signal (RH)	Output	Ignition switch ON	Turn signal switch OFF	0V
					Turn signal switch RH	 <p style="text-align: center;">6.5 V</p>
18 (G/Y)	Ground	Turn signal (LH)	Output	Ignition switch ON	Turn signal switch OFF	0V
					Turn signal switch LH	 <p style="text-align: center;">6.5 V</p>
19 (Y)	Ground	Room lamp timer control	Output	Interior room lamp	OFF	Battery voltage
					ON	0V
21 (P/B)	Ground	Optical sensor signal	Input	Ignition switch ON	When outside of the vehi- cle is bright	Close to 5V
					When outside of the vehi- cle is dark	Close to 0V
24 (R/W)	Ground	Stop lamp switch 1	Input	—	Battery voltage	
26 (O/L)	Ground	Stop lamp switch 2	Input	Stop lamp switch	OFF (brake pedal is re- leased)	0V
					ON (brake pedal is de- pressed)	Battery voltage
27 (O)	Ground	Front door lock as- sembly LH (unlock sensor)	Input	Front door LH	LOCK status	 <p style="text-align: center;">11.8V</p>
					UNLOCK status	0V
29 (Y)	Ground	Key slot switch	Input	When Intelligent Key is inserted into key slot	Battery voltage	
				When Intelligent Key is not inserted into key slot	0V	
31 (G)	Ground	Rear window defog- ger feedback signal	Input	Rear window de- fogger switch	OFF	0V
				ON	Battery voltage	

# BCM (BODY CONTROL MODULE)

## < ECU DIAGNOSIS INFORMATION >

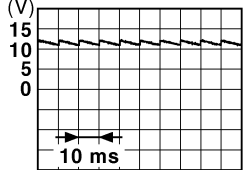
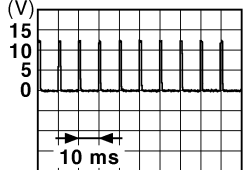
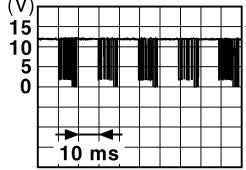
Terminal No. (Wire color)		Description		Condition	Value (Approx.)				
		Signal name	Input/ Output						
(+)	(-)								
32 (R/B)	Ground	Front door RH switch	Input	Front door RH switch	 <p style="text-align: right; margin-right: 50px;">11.8 V</p> <p style="text-align: right; font-size: small;">JPMIA0011GB</p>				
				ON (when front door RH opens)	0V				
37 (O)	Ground	Trunk lid opener cancel switch	Input	Trunk lid opener cancel switch	 <p style="text-align: right; margin-right: 50px;">1.1V</p> <p style="text-align: right; font-size: small;">JPMIA0012GB</p>				
				ON	0V				
38 (GR/W)	Ground	Rear window defogger ON signal	Input	Rear window defogger switch	<table style="width: 100%; border-collapse: collapse;"> <tr> <td style="width: 50%;">OFF</td> <td style="width: 50%;">5V</td> </tr> <tr> <td>ON</td> <td>0V</td> </tr> </table>	OFF	5V	ON	0V
				OFF	5V				
ON	0V								
40 (Y/G)	Ground	Power window serial link	Input/ Output	Ignition switch ON	 <p style="text-align: right; margin-right: 50px;">10.2V</p> <p style="text-align: right; font-size: small;">JPMIA0013GB</p>				
				Ignition switch OFF or ACC	0V				
41 (W)	Ground	Engine switch (push switch) illumination	Output	Engine switch (push switch) illumination	<table style="width: 100%; border-collapse: collapse;"> <tr> <td style="width: 50%;">ON</td> <td style="width: 50%;">5.5V</td> </tr> <tr> <td>OFF</td> <td>0V</td> </tr> </table>	ON	5.5V	OFF	0V
				ON	5.5V				
OFF	0V								
42 (R)	Ground	LOCK indicator lamp	Output	LOCK indicator lamp	<table style="width: 100%; border-collapse: collapse;"> <tr> <td style="width: 50%;">ON</td> <td style="width: 50%;">0V</td> </tr> <tr> <td>OFF</td> <td>Battery voltage</td> </tr> </table>	ON	0V	OFF	Battery voltage
				ON	0V				
OFF	Battery voltage								
45 (P)	Ground	Receiver & sensor ground	Input	Ignition switch ON	0V				
46 (V/W)	Ground	Receiver & sensor power supply output	Output	Ignition switch	<table style="width: 100%; border-collapse: collapse;"> <tr> <td style="width: 50%;">OFF</td> <td style="width: 50%;">0V</td> </tr> <tr> <td>ACC or ON</td> <td>5.0V</td> </tr> </table>	OFF	0V	ACC or ON	5.0V
				OFF	0V				
ACC or ON	5.0V								

# BCM (BODY CONTROL MODULE)

## < ECU DIAGNOSIS INFORMATION >

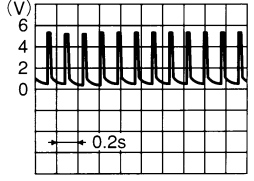
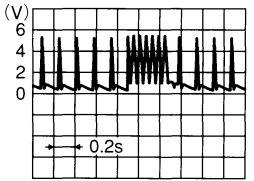
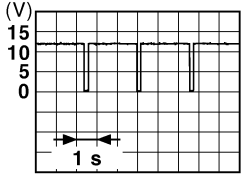
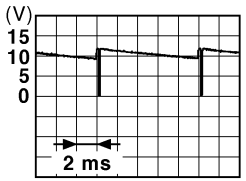
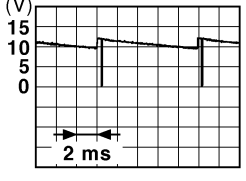
Terminal No. (Wire color)		Description		Condition	Value (Approx.)
(+)	(-)	Signal name	Input/ Output		
47 <sup>1</sup> (G/O)	Ground	Tire pressure receiver signal	Input/ Output	Ignition switch ON	Standby state  OCC3881D
				When receiving the signal from the transmitter  OCC3880D	
48 (R/G)	Ground	Selector lever transmission range switch signal	Input	Selector lever	P or N position 12.0V
				Except P and N positions 0V	
49 (L/O)	Ground	Security indicator signal	Output	Security indicator	ON 0V
				Blinking  11.3V JPMIA0014GB	
50 (LG/B)	Ground	Combination switch OUTPUT 5	Input	Combination switch (Wiper intermittent dial 4)	All switch OFF 0V
				Lighting switch 1ST	 10.7V JPMIA0031GB
				Lighting switch high-beam	
				Lighting switch 2ND	
Turn signal switch RH					
51 (L/W)	Ground	Combination switch OUTPUT 1	Input	Combination switch	All switch OFF (Wiper intermittent dial 4) 0V
				Any of the conditions below with all switch OFF • Wiper intermittent dial 1 • Wiper intermittent dial 2 • Wiper intermittent dial 3 • Wiper intermittent dial 6 • Wiper intermittent dial 7  10.7V JPMIA0032GB	

# BCM (BODY CONTROL MODULE)

## < ECU DIAGNOSIS INFORMATION >

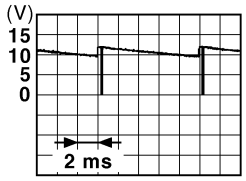
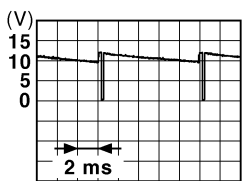
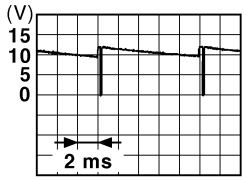
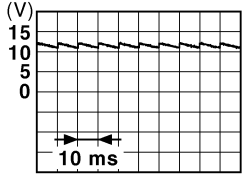
Terminal No. (Wire color)		Description		Condition	Value (Approx.)		
(+)	(-)	Signal name	Input/ Output				
52 (G/B)	Ground	Combination switch OUTPUT 2	Input	Combination switch	All switch OFF (Wiper intermittent dial 4)	0V	
					Front washer switch ON (Wiper intermittent dial 4)	 <p>10.7V</p>	
					Any of the conditions below with all switch OFF		
					<ul style="list-style-type: none"> <li>• Wiper intermittent dial 1</li> <li>• Wiper intermittent dial 5</li> <li>• Wiper intermittent dial 6</li> </ul>		
53 (LG/ R)	Ground	Combination switch OUTPUT 3	Input	Combination switch (Wiper intermit- tent dial 4)	All switch OFF	 <p>10.7V</p>	
					Front wiper switch INT		
					Front wiper switch LO		
					Lighting switch AUTO		
54 (G/Y)	Ground	Combination switch OUTPUT 4	Input	Combination switch (Wiper intermit- tent dial 4)	All switch OFF	 <p>10.7V</p>	
					Front fog lamp switch ON		
					Lighting switch 2ND		
					Lighting switch flash-to- pass		
					Turn signal switch LH		
57 <sup>1</sup> (W)	Ground	Tire pressure warn- ing check switch	Input	—	5V		
58 (SB)	Ground	Front door LH switch	Input	Front door LH switch	OFF (front door LH CLOSE)	 <p>11.8V</p>	
					ON (front door LH OPEN)		0V
59 (G/R)	Ground	Rear window defog- ger relay	Output	Rear window de- fogger	Active	Battery voltage	
				Not activated	0V		

A  
B  
C  
D  
E  
F  
G  
H  
I  
J  
K  
DEF  
M  
N  
O  
P

# BCM (BODY CONTROL MODULE)

## < ECU DIAGNOSIS INFORMATION >

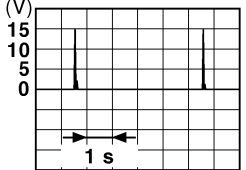
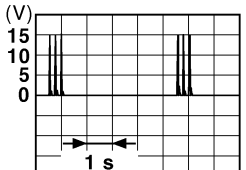
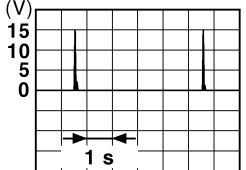
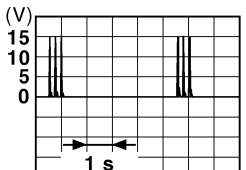
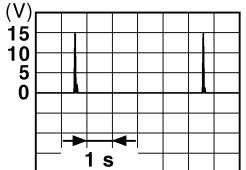
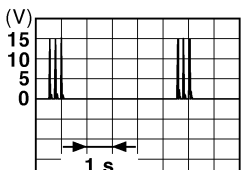
Terminal No. (Wire color)		Description		Condition	Value (Approx.)
(+)	(-)	Signal name	Input/ Output		
60 (B/R)	Ground	Front console antenna 2 (-)	Output	When Intelligent Key is in the passenger compartment	 <small>JMKIA0062GB</small>
				When Intelligent Key is not in the passenger compartment	 <small>JMKIA0063GB</small>
61 (W/R)	Ground	Center console antenna 2 (+)	Output	When Intelligent Key is in the passenger compartment	 <small>JMKIA0062GB</small>
				When Intelligent Key is not in the passenger compartment	 <small>JMKIA0063GB</small>
62 (V)	Ground	Front outside handle RH antenna (-)	Output	When the front door RH request switch is operated with ignition switch OFF	 <small>JMKIA0062GB</small>
				When Intelligent Key is not in the antenna detection area	 <small>JMKIA0063GB</small>



# BCM (BODY CONTROL MODULE)





## < ECU DIAGNOSIS INFORMATION >

Terminal No. (Wire color)		Description		Condition	Value (Approx.)
(+)	(-)	Signal name	Input/ Output		
63 (P)	Ground	Front outside handle RH antenna (+)	Output	When Intelligent Key is in the antenna detection area	<p style="text-align: right; font-size: small;">JMKIA0062GB</p>
				When the front door RH request switch is operat- ed with ignition switch OFF	<p style="text-align: right; font-size: small;">JMKIA0063GB</p>
64 (V)	Ground	Front outside handle LH antenna (-)	Output	When Intelligent Key is in the antenna detection area	<p style="text-align: right; font-size: small;">JMKIA0062GB</p>
				When the front door LH request switch is operat- ed with ignition switch OFF	<p style="text-align: right; font-size: small;">JMKIA0063GB</p>
65 (P)	Ground	Front outside handle LH antenna (+)	Output	When Intelligent Key is in the antenna detection area	<p style="text-align: right; font-size: small;">JMKIA0062GB</p>
				When the front door LH request switch is operat- ed with ignition switch OFF	<p style="text-align: right; font-size: small;">JMKIA0063GB</p>

A  
B  
C  
D  
E  
F  
G  
H  
I  
J  
K  
DEF  
M  
N  
O  
P

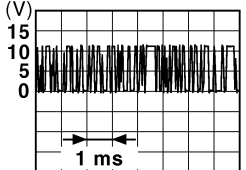
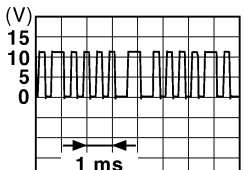

# BCM (BODY CONTROL MODULE)

## < ECU DIAGNOSIS INFORMATION >

Terminal No. (Wire color)		Description		Condition		Value (Approx.)
(+)	(-)	Signal name	Input/ Output			
68 (G/O)	Ground	NATS antenna amp (built in key slot)	Input/ Output	During waiting	Ignition switch is pressed while inserting the Intelli- gent Key into the key slot.	Just after pressing ignition switch. Pointer of tester should move.
69 (O)	Ground	NATS antenna amp (built in key slot)	Input/ Output	During waiting	Ignition switch is pressed while inserting the Intelli- gent Key into the key slot.	Just after pressing ignition switch. Pointer of tester should move.
70 (R/B)	Ground	Ignition relay-2 con- trol	Output	Ignition switch	OFF or ACC	0V
					ON	Battery voltage
71 (L/O)	Ground	Remote keyless entry receiver signal	Input/ Output	During waiting		 <p style="text-align: right; font-size: small;">JMKIA0064GB</p>
				When operating either button on Intelligent Key		 <p style="text-align: right; font-size: small;">JMKIA0065GB</p>
75 (R/Y)	Ground	Combination switch INPUT 5	Output	Combination switch	All switch OFF (Wiper intermittent dial 4)	 <p style="text-align: right; font-size: small;">JPMIA0041GB</p> <p style="text-align: center;">1.4V</p>
					Front fog lamp switch ON (Wiper intermittent dial 4)	 <p style="text-align: right; font-size: small;">JPMIA0037GB</p> <p style="text-align: center;">1.3V</p>
					Any of the conditions below with all switch OFF <ul style="list-style-type: none"> <li>• Wiper intermittent dial 1</li> <li>• Wiper intermittent dial 2</li> <li>• Wiper intermittent dial 6</li> <li>• Wiper intermittent dial 7</li> </ul>	 <p style="text-align: right; font-size: small;">JPMIA0040GB</p> <p style="text-align: center;">1.3V</p>

# BCM (BODY CONTROL MODULE)

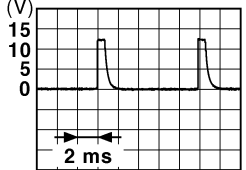
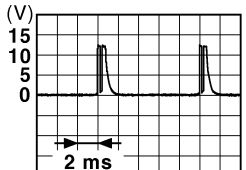
## < ECU DIAGNOSIS INFORMATION >

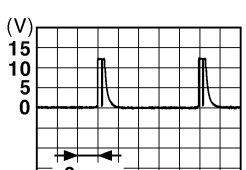
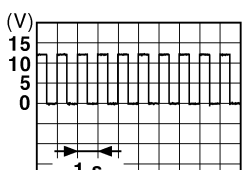
Terminal No. (Wire color)		Description		Condition	Value (Approx.)
(+)	(-)	Signal name	Input/ Output		
76 (R/G)	Ground	Combination switch INPUT 3	Output	Combination switch	All switch OFF (Wiper intermittent dial 4)  1.4V
					Lighting switch high-beam (Wiper intermittent dial 4)  1.3V
					Lighting switch 2ND (Wiper intermittent dial 4)  1.3V
					Any of the conditions below with all switch OFF • Wiper intermittent dial 1 • Wiper intermittent dial 2 • Wiper intermittent dial 3  1.3V
78 (P)	Ground	CAN-L	Input/ Output	—	—
79 (L)	Ground	CAN-H	Input/ Output	—	—
80 (R/L)	Ground	Key slot illumination	Output	Key slot illumina- tion	OFF 0V
					Blinking  6.5V
81 (LG)	Ground	ON indicator lamp	Output	Ignition switch	OFF or ACC 0V
				ON Battery voltage	

A  
B  
C  
D  
E  
F  
G  
H  
I  
J  
K

DEF

M  
N  
O  
P

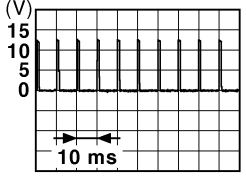
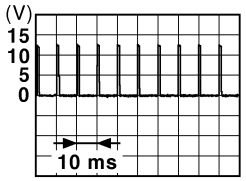

# BCM (BODY CONTROL MODULE)

## < ECU DIAGNOSIS INFORMATION >

Terminal No. (Wire color)		Description		Condition		Value (Approx.)
(+)	(-)	Signal name	Input/ Output			
83 (L)	Ground	ACC relay control	Output	Ignition switch	OFF	0V
					ACC or ON	Battery voltage
84 (Y/R)	Ground	CVT shift selector	Output	—		Battery voltage
87 (G/B)	Ground	Selector lever P position switch	Input	Selector lever	P position	0V
					Any position other than P	Battery voltage
88 (R)	Ground	Front door RH request switch	Input	Front door RH request switch	ON (pressed)	0V
					OFF (not pressed)	
89 (R)	Ground	Front door LH request switch	Input	Front door LH request switch	ON (pressed)	0V
					OFF (not pressed)	
90 (Y)	Ground	Blower fan motor relay control	Output	Ignition switch	OFF or ACC	0V
					ON	Battery voltage
91 (L/R)	Ground	Remote keyless entry receiver power supply	Output	Ignition switch OFF		Battery voltage

# BCM (BODY CONTROL MODULE)

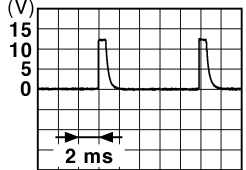
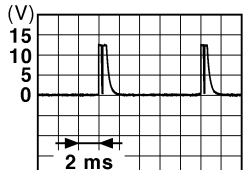
## < ECU DIAGNOSIS INFORMATION >

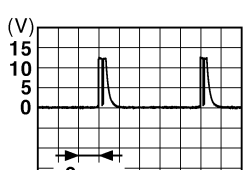
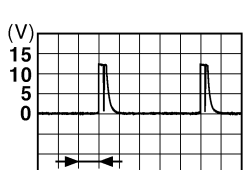
Terminal No. (Wire color)		Description		Condition	Value (Approx.)
(+)	(-)	Signal name	Input/ Output		
95 (R/W)	Ground	Combination switch INPUT 1	Output	Combination switch (Wiper intermittent dial 4)	All switch OFF  1.4V
					Turn signal switch LH  1.3V
					Turn signal switch RH  1.3V
					Front wiper switch LO  1.3V
					Front washer switch ON  1.3V

A  
B  
C  
D  
E  
F  
G  
H  
I  
J  
K  
DEF  
M  
N  
O  
P

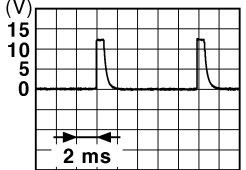
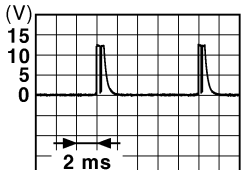
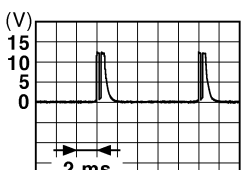
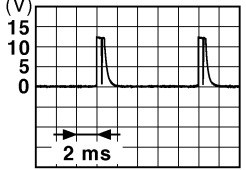

# BCM (BODY CONTROL MODULE)

## < ECU DIAGNOSIS INFORMATION >

Terminal No. (Wire color)		Description		Condition	Value (Approx.)
(+)	(-)	Signal name	Input/ Output		
96 (P/B)	Ground	Combination switch INPUT 4	Output Combination switch	All switch OFF (Wiper intermittent dial 4)	 <p style="text-align: right; font-size: small;">JPMIA0041GB</p> <p style="text-align: center;">1.4V</p>
				Lighting switch AUTO (Wiper intermittent dial 4)	 <p style="text-align: right; font-size: small;">JPMIA0038GB</p> <p style="text-align: center;">1.3V</p>
				Lighting switch 1ST (Wiper intermittent dial 4)	 <p style="text-align: right; font-size: small;">JPMIA0036GB</p> <p style="text-align: center;">1.3V</p>
				Any of the conditions below with all switch OFF	<ul style="list-style-type: none"> <li>• Wiper intermittent dial 1</li> <li>• Wiper intermittent dial 5</li> <li>• Wiper intermittent dial 6</li> </ul>  <p style="text-align: right; font-size: small;">JPMIA0039GB</p> <p style="text-align: center;">1.3V</p>

# BCM (BODY CONTROL MODULE)

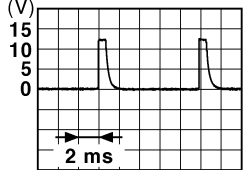
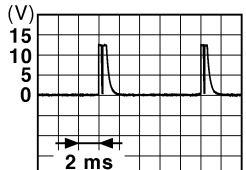
## < ECU DIAGNOSIS INFORMATION >

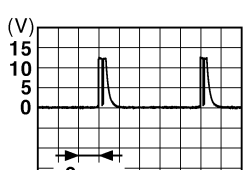
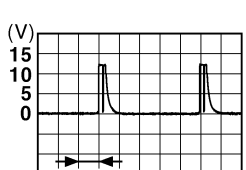
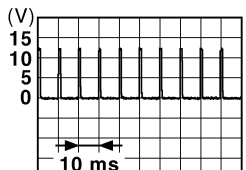
Terminal No. (Wire color)		Description		Condition	Value (Approx.)	
(+)	(-)	Signal name	Input/ Output			
97 (R/B)	Ground	Combination switch INPUT 2	Output	Combination switch (Wiper intermit- tent dial 4)	All switch OFF	 <p style="text-align: right; font-size: small;">JP MIA0041GB</p> <p style="text-align: center;">1.4V</p>
					Lighting switch flash-to-pass	 <p style="text-align: right; font-size: small;">JP MIA0037GB</p> <p style="text-align: center;">1.3V</p>
					Lighting switch 2ND	 <p style="text-align: right; font-size: small;">JP MIA0036GB</p> <p style="text-align: center;">1.3V</p>
					Front wiper switch INT	 <p style="text-align: right; font-size: small;">JP MIA0038GB</p> <p style="text-align: center;">1.3V</p>
					Front wiper switch HI	 <p style="text-align: right; font-size: small;">JP MIA0040GB</p> <p style="text-align: center;">1.3V</p>
					Pressed	0 V
98 (G/O)	Ground	Hazard switch	Input	Hazard switch	Not pressed	 <p style="text-align: right; font-size: small;">JP MIA0012GB</p> <p style="text-align: center;">1.1V</p>

A  
B  
C  
D  
E  
F  
G  
H  
I  
J  
K  
DEF  
M  
N  
O  
P

# BCM (BODY CONTROL MODULE)

## < ECU DIAGNOSIS INFORMATION >

Terminal No. (Wire color)		Description		Condition		Value (Approx.)
(+)	(-)	Signal name	Input/ Output			
103 (V)	Ground	Trunk lid opening.	Output	Trunk lid	Open (trunk lid opener actuator is activated)	Battery voltage
					Close (trunk lid opener actuator is not activated)	0V
110 (V/W)	Ground	Trunk room lamp	Output	Trunk room lamp	ON	0V
					OFF	Battery voltage
114 (B)	Ground	Trunk room antenna 1 (-)	Output	Ignition switch OFF	When Intelligent Key is in the passenger compartment	<p style="text-align: right; font-size: small;">JMKIA0062GB</p>
					When Intelligent Key is not in the passenger compartment	<p style="text-align: right; font-size: small;">JMKIA0063GB</p>
115 (W)	Ground	Trunk room antenna 1 (+)	Output	Ignition switch OFF	When Intelligent Key is in the passenger compartment	<p style="text-align: right; font-size: small;">JMKIA0062GB</p>
					When Intelligent Key is not in the passenger compartment	<p style="text-align: right; font-size: small;">JMKIA0063GB</p>



# BCM (BODY CONTROL MODULE)

## < ECU DIAGNOSIS INFORMATION >

Terminal No. (Wire color)		Description		Condition	Value (Approx.)
(+)	(-)	Signal name	Input/ Output		
118 (L/O)	Ground	Rear bumper antenna (-)	Output	When the trunk lid request switch is operated with ignition switch OFF	<p style="text-align: right; font-size: small;">JMKIA0062GB</p>
				When Intelligent Key is not in the antenna detection area	<p style="text-align: right; font-size: small;">JMKIA0063GB</p>
119 (BR/W)	Ground	Rear bumper antenna (+)	Output	When the trunk lid request switch is operated with ignition switch OFF	<p style="text-align: right; font-size: small;">JMKIA0062GB</p>
				When Intelligent Key is not in the antenna detection area	<p style="text-align: right; font-size: small;">JMKIA0063GB</p>
127 (BR/W)	Ground	Ignition relay (IPDM E/R) control	Output	Ignition switch	OFF or ACC Battery voltage ON 0V
130 (W)	Ground	Trunk room lamp switch	Input	Trunk room lamp switch	OFF (trunk is closed) <p style="text-align: right; font-size: small;">JPMIA0011GB</p> 11.8V
					ON (trunk is open)
132 (R)	Ground	Starter motor relay control	Output	Ignition switch ON	When selector lever is in P or N position and the brake is depressed Battery voltage When selector lever is in P or N position and the brake is not depressed 0V

A  
B  
C  
D  
E  
F  
G  
H  
I  
J  
K

DEF

M  
N  
O  
P

# BCM (BODY CONTROL MODULE)

## < ECU DIAGNOSIS INFORMATION >

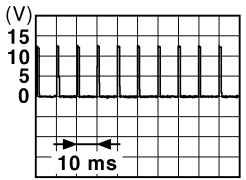
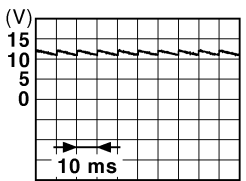
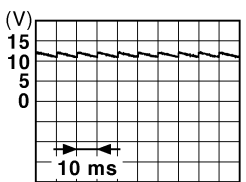
Terminal No. (Wire color)		Description		Condition		Value (Approx.)
(+)	(-)	Signal name	Input/ Output			
140 (BR)	Ground	Engine switch (push switch)	Input	Engine switch (push switch)	Pressed	0V
					Not pressed	Battery voltage
141 (BR)	Ground	Trunk request switch	Input	Trunk request switch	ON (pressed)	0V
					OFF (not pressed)	 <p style="text-align: center;">1.0V</p>
144 (GR)	Ground	Request switch buzzer	Output	Request switch buzzer	Sounding	0V
					Not sounding	Battery voltage
147 (L/R)	Ground	Trunk lid opener switch	Input	Trunk lid opener switch	Pressed	0V
					Not pressed	Battery voltage
148 (R/W)	Ground	Rear door RH switch	Input	Rear door RH switch	OFF (when rear door RH closes)	 <p style="text-align: center;">11.8V</p>
					ON (when rear door RH opens)	0V
149 (R/B)	Ground	Rear door LH switch	Input	Rear door LH switch	OFF (when rear door LH closes)	 <p style="text-align: center;">11.8V</p>
					ON (when rear door LH opens)	0V

1 : With low tire pressure monitoring system

## Fail Safe

INFOID:000000007806821

Display contents of CONSULT	Fail-safe	Cancellation
B2190: NATS ANTENNA AMP	Inhibit engine cranking	Erase DTC
B2191: DIFFERENCE OF KEY	Inhibit engine cranking	Erase DTC
B2192: ID DISCORD BCM-ECM	Inhibit engine cranking	Erase DTC
B2193: CHAIN OF BCM-ECM	Inhibit engine cranking	Erase DTC
B2195: ANTI-SCANNING	Inhibit engine cranking	Erase DTC

# BCM (BODY CONTROL MODULE)

## < ECU DIAGNOSIS INFORMATION >

Display contents of CONSULT	Fail-safe	Cancellation	
B2560: STARTER CONT RELAY	Inhibit engine cranking	500 ms after the following CAN signal communication status has become consistent • Starter control relay signal • Starter relay status signal	A
B2562: LO VOLTAGE	Inhibit engine cranking	100 ms after the power supply voltage increases to more than 8.8 V	B
B2608: STARTER RELAY	Inhibit engine cranking	500 ms after the following signal communication status becomes consistent • Starter motor relay control signal • Starter relay status signal (CAN)	C
B260A: IGNITION RELAY	Inhibit engine cranking	500 ms after the following conditions are fulfilled • IGN relay (IPDM E/R) control signal: OFF (Battery voltage) • Ignition ON signal (CAN to IPDM E/R): OFF (Request signal) • Ignition ON signal (CAN from IPDM E/R): OFF (Condition signal)	D
B260F: ENG STATE SIG LOST	Maintains the power supply position attained at the time of DTC detection	When any of the following conditions is fulfilled • Power position changes to ACC • Receives engine status signal (CAN)	E
B2617: STARTER RELAY CIRC	Inhibit engine cranking	1 second after the starter motor relay control inside BCM becomes normal	F
B2618: BCM	Inhibit engine cranking	1 second after the ignition relay (IPDM E/R) control inside BCM becomes normal	G
B26E1: ENG STATE NO RECIV	Inhibit engine cranking	When any of the following conditions are fulfilled • Power position changes to ACC • Receives engine status signal (CAN)	H

## DTC Inspection Priority Chart

INFOID:000000007806822

If some DTCs are displayed at the same time, perform inspections one by one based on the following priority chart.

Priority	DTC	
1	• B2562: LO VOLTAGE	J
2	• U1000: CAN COMM CIRCUIT • U1010: CONTROL UNIT (CAN)	K
3	• B2190: NATS ANTENNA AMP • B2191: DIFFERENCE OF KEY • B2192: ID DISCORD BCM-ECM • B2193: CHAIN OF BCM-ECM	DEF
4	• B2553: IGNITION RELAY • B2555: STOP LAMP • B2556: PUSH-BTN IGN SW • B2557: VEHICLE SPEED • B2560: STARTER CONT RELAY • B2601: SHIFT POSITION • B2602: SHIFT POSITION • B2603: SHIFT POSI STATUS • B2604: PNP SWITCH • B2605: PNP SWITCH • B2608: STARTER RELAY • B260A: IGNITION RELAY • B260F: ENG STATE SIG LOST • B2614: ACC RELAY CIRC • B2615: BLOWER RELAY CIRC • B2616: IGN RELAY CIRC • B2617: STARTER RELAY CIRC • B2618: BCM • B261A: PUSH-BTN IGN SW • B26E1: ENG STATE NO RECIV • C1729: VHCL SPEED SIG ERR • U0415: VEHICLE SPEED SIG	M N O P

# BCM (BODY CONTROL MODULE)

## < ECU DIAGNOSIS INFORMATION >

Priority	DTC
5	<ul style="list-style-type: none"> <li>• C1704: LOW PRESSURE FL</li> <li>• C1705: LOW PRESSURE FR</li> <li>• C1706: LOW PRESSURE RR</li> <li>• C1707: LOW PRESSURE RL</li> <li>• C1708: [NO DATA] FL</li> <li>• C1709: [NO DATA] FR</li> <li>• C1710: [NO DATA] RR</li> <li>• C1711: [NO DATA] RL</li> <li>• C1712: [CHECKSUM ERR] FL</li> <li>• C1713: [CHECKSUM ERR] FR</li> <li>• C1714: [CHECKSUM ERR] RR</li> <li>• C1715: [CHECKSUM ERR] RL</li> <li>• C1716: [PRESSDATA ERR] FL</li> <li>• C1717: [PRESSDATA ERR] FR</li> <li>• C1718: [PRESSDATA ERR] RR</li> <li>• C1719: [PRESSDATA ERR] RL</li> <li>• C1720: [CODE ERR] FL</li> <li>• C1721: [CODE ERR] FR</li> <li>• C1722: [CODE ERR] RR</li> <li>• C1723: [CODE ERR] RL</li> <li>• C1724: [BATT VOLT LOW] FL</li> <li>• C1725: [BATT VOLT LOW] FR</li> <li>• C1726: [BATT VOLT LOW] RR</li> <li>• C1727: [BATT VOLT LOW] RL</li> <li>• C1734: CONTROL UNIT</li> </ul>
6	<ul style="list-style-type: none"> <li>• B2622: INSIDE ANTENNA</li> <li>• B2623: INSIDE ANTENNA</li> </ul>

## DTC Index

INFOID:000000007806823

### NOTE:

- Details of time display
- CRNT: Displays when there is a malfunction now or after returning to the normal condition until turning ignition switch OFF → ON again.
- 1 - 39: Displayed if any previous malfunction is present when current condition is normal. It increases 1 → 2 → 3...38 → 39 after returning to the normal condition whenever ignition switch OFF → ON. The counter remains at 39 even if the number of cycles exceeds it. It is counted from 1 again when turning ignition switch OFF → ON after returning to the normal condition if the malfunction is detected again.

CONSULT display	Fail-safe	Intelligent Key warning lamp ON	Tire pressure monitor warning lamp ON	Reference page
No DTC is detected. further testing may be required.	—	—	—	—
U1000: CAN COMM CIRCUIT	—	—	—	<a href="#">BCS-32</a>
U1010: CONTROL UNIT (CAN)	—	—	—	<a href="#">BCS-33</a>
U0415: VEHICLE SPEED SIG	—	—	—	<a href="#">BCS-34</a>
B2190: NATS ANTENNA AMP	×	—	—	<a href="#">SEC-37</a>
B2191: DIFFERENCE OF KEY	×	—	—	<a href="#">SEC-40</a>
B2192: ID DISCORD BCM-ECM	×	—	—	<a href="#">SEC-41</a>
B2193: CHAIN OF BCM-ECM	×	—	—	<a href="#">SEC-42</a>
B2553: IGNITION RELAY	—	—	—	<a href="#">PCS-46</a>
B2555: STOP LAMP	—	—	—	<a href="#">SEC-43</a>
B2556: PUSH-BTN IGN SW	—	×	—	<a href="#">SEC-46</a>
B2557: VEHICLE SPEED	×	×	—	<a href="#">SEC-48</a>
B2560: STARTER CONT RELAY	×	×	—	<a href="#">SEC-49</a>

## BCM (BODY CONTROL MODULE)

### < ECU DIAGNOSIS INFORMATION >

CONSULT display	Fail-safe	Intelligent Key warning lamp ON	Tire pressure monitor warning lamp ON	Reference page	
B2562: LOW VOLTAGE	—	—	—	<a href="#">BCS-35</a>	A
B2601: SHIFT POSITION	×	×	—	<a href="#">SEC-50</a>	B
B2602: SHIFT POSITION	×	×	—	<a href="#">SEC-53</a>	
B2603: SHIFT POSI STATUS	×	×	—	<a href="#">SEC-56</a>	C
B2604: PNP SWITCH	×	×	—	<a href="#">SEC-59</a>	
B2605: PNP SWITCH	×	×	—	<a href="#">SEC-61</a>	
B2608: STARTER RELAY	×	×	—	<a href="#">SEC-63</a>	D
B260A: IGNITION RELAY	×	×	—	<a href="#">PCS-48</a>	
B260F: ENG STATE SIG LOST	×	×	—	<a href="#">SEC-65</a>	E
B2614: ACC RELAY CIRC	—	×	—	<a href="#">PCS-50</a>	
B2615: BLOWER RELAY CIRC	—	×	—	<a href="#">PCS-53</a>	
B2616: IGN RELAY CIRC	—	×	—	<a href="#">PCS-56</a>	F
B2617: STARTER RELAY CIRC	×	×	—	<a href="#">SEC-67</a>	
B2618: BCM	×	×	—	<a href="#">PCS-59</a>	G
B261A: PUSH-BTN IGN SW	—	×	—	<a href="#">PCS-60</a>	
B2622: INSIDE ANTENNA	—	—	—	<a href="#">DLK-56</a>	
B2623: INSIDE ANTENNA	—	—	—	<a href="#">DLK-59</a>	H
B26E1: ENG STATE NO RES	×	×	—	<a href="#">SEC-66</a>	
C1704: LOW PRESSURE FL	—	—	×	<a href="#">WT-43</a>	I
C1705: LOW PRESSURE FR	—	—	×	<a href="#">WT-43</a>	
C1706: LOW PRESSURE RR	—	—	×	<a href="#">WT-43</a>	
C1707: LOW PRESSURE RL	—	—	×	<a href="#">WT-43</a>	J
C1708: [NO DATA] FL	—	—	×	<a href="#">WT-13</a>	
C1709: [NO DATA] FR	—	—	×	<a href="#">WT-13</a>	
C1710: [NO DATA] RR	—	—	×	<a href="#">WT-13</a>	K
C1711: [NO DATA] RL	—	—	×	<a href="#">WT-13</a>	
C1712: [CHECKSUM ERR] FL	—	—	×	<a href="#">WT-15</a>	DEF
C1713: [CHECKSUM ERR] FR	—	—	×	<a href="#">WT-15</a>	
C1714: [CHECKSUM ERR] RR	—	—	×	<a href="#">WT-15</a>	
C1715: [CHECKSUM ERR] RL	—	—	×	<a href="#">WT-15</a>	M
C1716: [PRESSDATA ERR] FL	—	—	×	<a href="#">WT-17</a>	
C1717: [PRESSDATA ERR] FR	—	—	×	<a href="#">WT-17</a>	
C1718: [PRESSDATA ERR] RR	—	—	×	<a href="#">WT-17</a>	N
C1719: [PRESSDATA ERR] RL	—	—	×	<a href="#">WT-17</a>	
C1720: [CODE ERR] FL	—	—	×	<a href="#">WT-15</a>	O
C1721: [CODE ERR] FR	—	—	×	<a href="#">WT-15</a>	
C1722: [CODE ERR] RR	—	—	×	<a href="#">WT-15</a>	
C1723: [CODE ERR] RL	—	—	×	<a href="#">WT-15</a>	P
C1724: [BATT VOLT LOW] FL	—	—	×	<a href="#">WT-15</a>	
C1725: [BATT VOLT LOW] FR	—	—	×	<a href="#">WT-15</a>	
C1726: [BATT VOLT LOW] RR	—	—	×	<a href="#">WT-15</a>	
C1727: [BATT VOLT LOW] RL	—	—	×	<a href="#">WT-15</a>	

## BCM (BODY CONTROL MODULE)

### < ECU DIAGNOSIS INFORMATION >

CONSULT display	Fail-safe	Intelligent Key warning lamp ON	Tire pressure monitor warning lamp ON	Reference page
C1729: VHCL SPEED SIG ERR	—	—	×	<a href="#">WT-19</a>
C1734: CONTROL UNIT	—	—	×	<a href="#">WT-20</a>

# REAR WINDOW DEFOGGER

< WIRING DIAGRAM >

## WIRING DIAGRAM

### REAR WINDOW DEFOGGER

Wiring Diagram

INFOID:000000007252917

◊ CD ◊ : WITH COLOR DISPLAY  
 ◊ HM ◊ : WITH HEATED MIRRORS  
 ◊ MC ◊ : WITH MONOCHROME DISPLAY

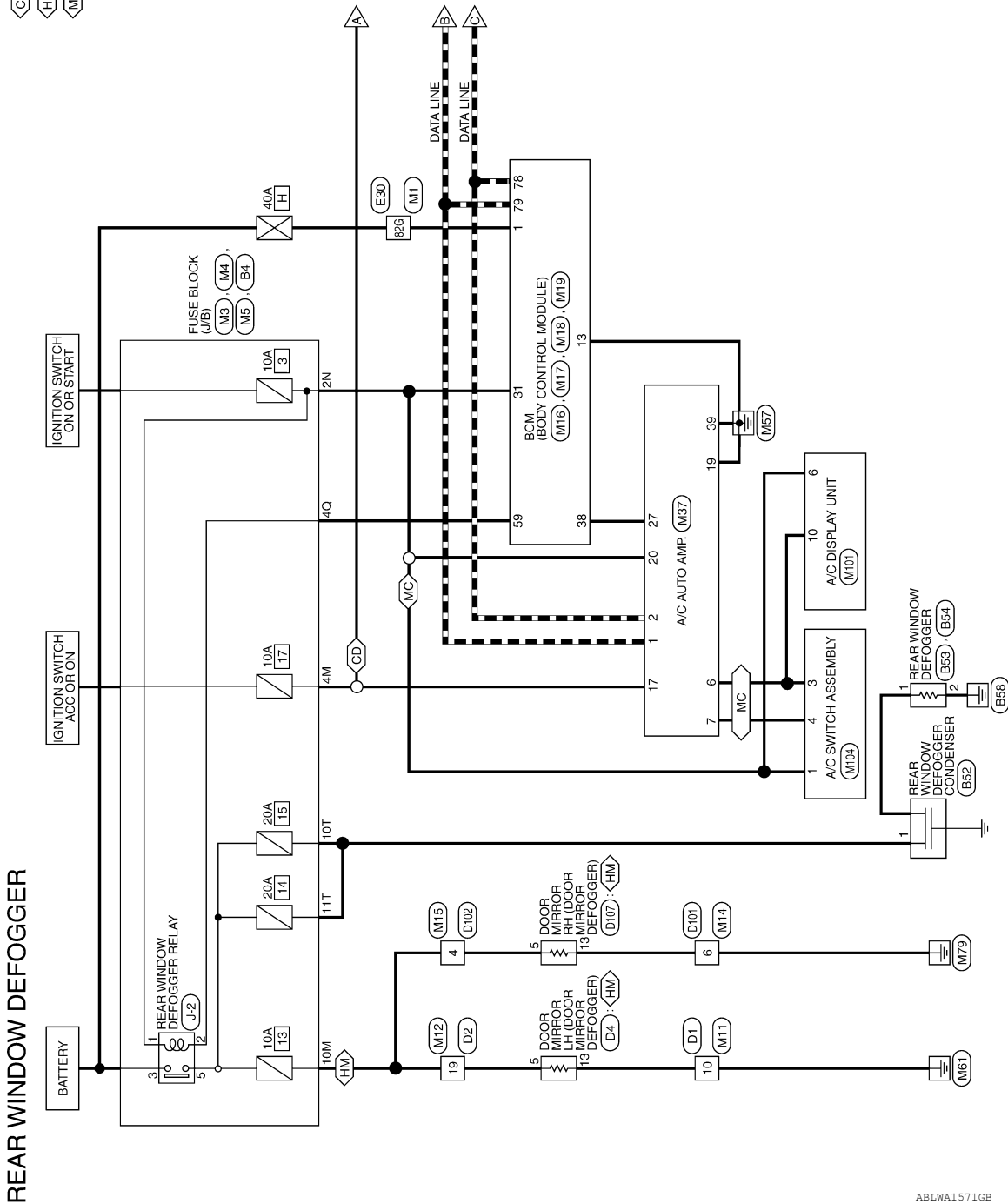

A  
B  
C  
D  
E  
F  
G  
H  
I  
J  
K  
DEF  
M  
N  
O  
P

# REAR WINDOW DEFOGGER

< WIRING DIAGRAM >

EN : WITHOUT NAVI  
 NV : WITH NAVI

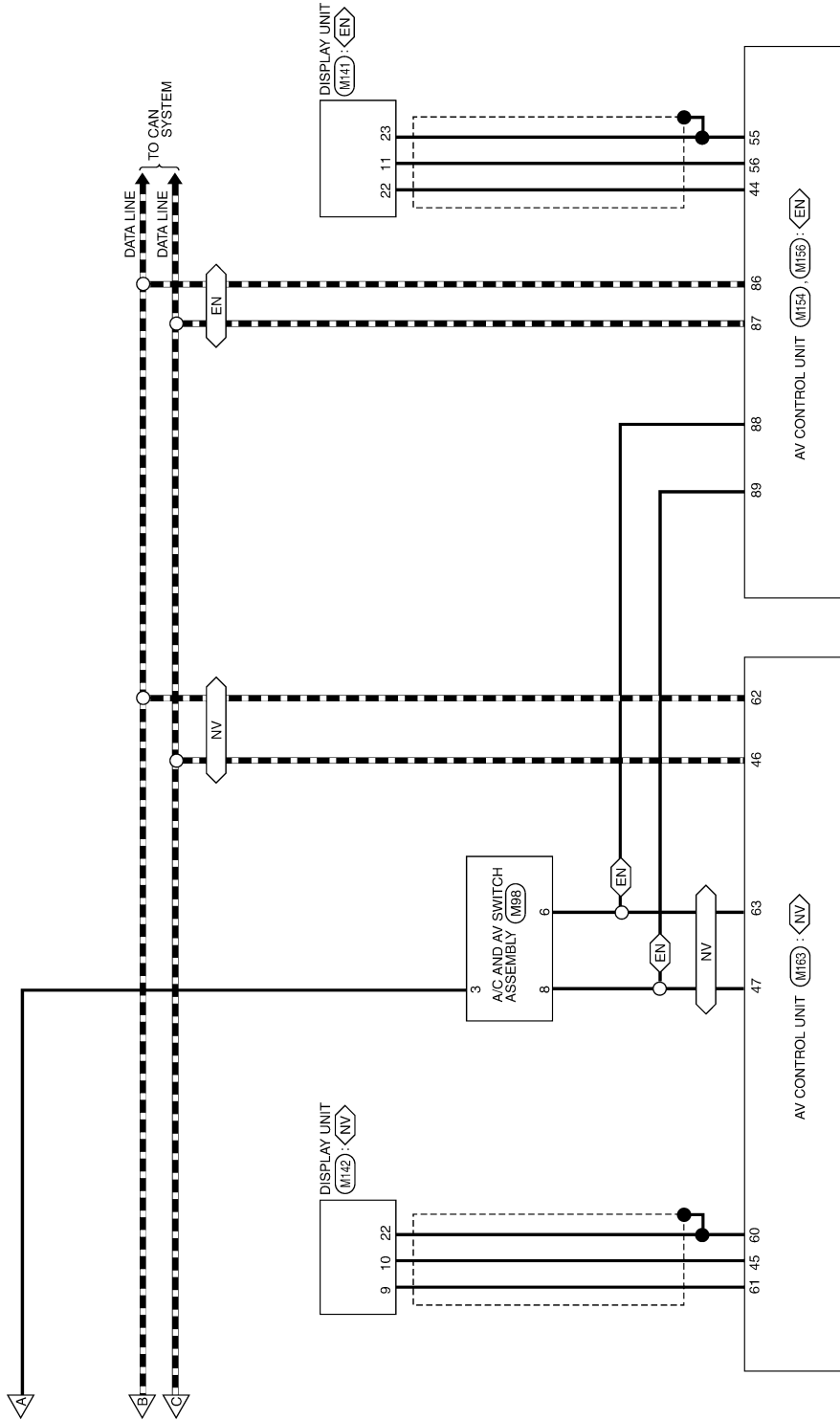

ABLWA1132GB



# REAR WINDOW DEFOGGER

< WIRING DIAGRAM >

## REAR WINDOW DEFOGGER CONNECTORS

Connector No.	M1
Connector Name	WIRE TO WIRE
Connector Color	WHITE

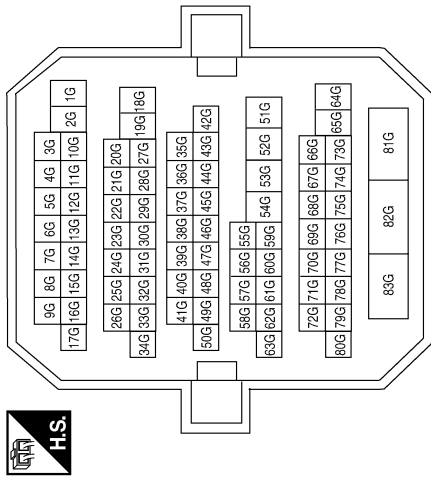

Terminal No.	82G	Color of Wire	W/B	Signal Name	-
--------------	-----	---------------	-----	-------------	---

Connector No.	M3
Connector Name	FUSE BLOCK (J/B)
Connector Color	WHITE

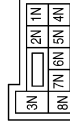

Terminal No.	2N	Color of Wire	G	Signal Name	-
--------------	----	---------------	---	-------------	---

Connector No.	M4
Connector Name	FUSE BLOCK (J/B)
Connector Color	WHITE

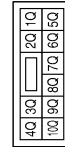

Terminal No.	4Q	Color of Wire	G/R	Signal Name	-
--------------	----	---------------	-----	-------------	---

Connector No.	M5
Connector Name	FUSE BLOCK (J/B)
Connector Color	WHITE

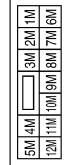

Terminal No.	4M	Color of Wire	V/Y	Signal Name	-
Terminal No.	10M	Color of Wire	O	Signal Name	-

Connector No.	M11
Connector Name	WIRE TO WIRE
Connector Color	WHITE

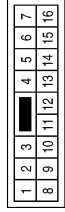

Terminal No.	10	Color of Wire	B	Signal Name	-
--------------	----	---------------	---	-------------	---

ABLIA3293GB

A  
B  
C  
D  
E  
F  
G  
H  
I  
J  
K  
DEF  
M  
N  
O  
P

# REAR WINDOW DEFOGGER

< WIRING DIAGRAM >

Connector No.	M15
Connector Name	WIRE TO WIRE
Connector Color	WHITE

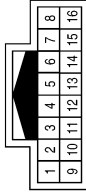

Terminal No.	4	Color of Wire	O	Signal Name	-
--------------	---	---------------	---	-------------	---

Connector No.	M14
Connector Name	WIRE TO WIRE
Connector Color	WHITE

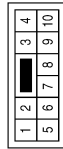

Terminal No.	6	Color of Wire	B	Signal Name	-
--------------	---	---------------	---	-------------	---

Connector No.	M12
Connector Name	WIRE TO WIRE
Connector Color	WHITE

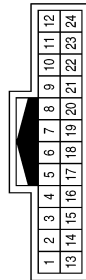

Terminal No.	19	Color of Wire	O	Signal Name	-
--------------	----	---------------	---	-------------	---

Connector No.	M18
Connector Name	BCM (BODY CONTROL MODULE)
Connector Color	GREEN



Terminal No.	31	Color of Wire	G	Signal Name	IGN F/B
	38		GR/W		REAR DEFOGGER SW
	59		G/R		REAR DEFOGGER

Connector No.	M17
Connector Name	BCM (BODY CONTROL MODULE)
Connector Color	WHITE

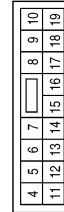

Terminal No.	13	Color of Wire	B	Signal Name	GND1
--------------	----	---------------	---	-------------	------

Connector No.	M16
Connector Name	BCM (BODY CONTROL MODULE)
Connector Color	BLACK



Terminal No.	1	Color of Wire	W/B	Signal Name	BATT (F/L)
--------------	---	---------------	-----	-------------	------------

ABL1A1734GB

# REAR WINDOW DEFOGGER

< WIRING DIAGRAM >

Terminal No.	Color of Wire	Signal Name
1	L	CAN-H
2	P	CAN-L
6	L	TX (AMP>SW&DISP) (WITH MONOCHROME DISPLAY)
7	P	RX (SW>AMP) (WITH MONOCHROME DISPLAY)
17	V/Y	ACC
19	B	GND
20	G	IGN
27	GRW	RR DEF ON
39	B	GND (POWER)

Connector No.	M37
Connector Name	A/C AUTO AMP.
Connector Color	WHITE

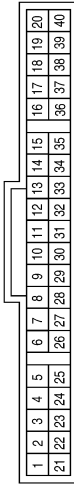

Connector No.	M19
Connector Name	BCM (BODY CONTROL MODULE)
Connector Color	BLACK

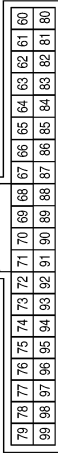

Terminal No.	Color of Wire	Signal Name
78	P	CAN-L
79	L	CAN-H

Connector No.	M104
Connector Name	A/C SWITCH ASSEMBLY
Connector Color	WHITE

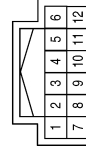

Connector No.	M101
Connector Name	A/C DISPLAY UNIT
Connector Color	BLACK

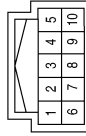

Terminal No.	Color of Wire	Signal Name
1	G	IGN
3	L	RX (AMP>SW)
4	P	TX (SW>AMP)

Terminal No.	Color of Wire	Signal Name
6	G	IGN
10	L	RX (AMP>DISP)

Connector No.	M88
Connector Name	A/C AND AV SWITCH ASSEMBLY
Connector Color	WHITE

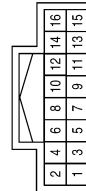

Terminal No.	Color of Wire	Signal Name
3	V/Y	ACC
6	L	CAN-H
8	P	CAN-L

ABLIA3294GB

A  
B  
C  
D  
E  
F  
G  
H  
I  
J  
K  
DEF  
M  
N  
O  
P

# REAR WINDOW DEFOGGER

< WIRING DIAGRAM >

Connector No.	M154
Connector Name	AV CONTROL UNIT (WITHOUT NAVI)
Connector Color	WHITE



47	46	45	44	43	42	41	40	39	38	37	36
59	58	57	56	55	54	53	52	51	50	49	48

Terminal No.	Color of Wire	Signal Name
44	BR	DISP IT
55	SHIELD	SHIELD
56	Y	IT DISP

Connector No.	M142
Connector Name	DISPLAY UNIT (WITH COLOR DISPLAY AND NAVI)
Connector Color	WHITE



12	11	10	9	8	7	6	5	4	3	2	1
24	23	22	21	20	19	18	17	16	15	14	13

Terminal No.	Color of Wire	Signal Name
9	BR	DISP IT
10	Y	IT DISP
22	SHIELD	SHIELD

Connector No.	M141
Connector Name	DISPLAY UNIT (WITH COLOR DISPLAY WITHOUT NAVI)
Connector Color	WHITE



12	11	10	9	8	7	6	5	4	3	2	1
24	23	22	21	20	19	18	17	16	15	14	13

Terminal No.	Color of Wire	Signal Name
11	Y	IT DISP
22	BR	DISP IT
23	SHIELD	BUS GND

Connector No.	M163
Connector Name	AV CONTROL UNIT (WITH NAVI)
Connector Color	WHITE



33	34	35	36	37	38	39	40	41	42	43	44	45	46	47	48
49	50	51	52	53	54	55	56	57	58	59	60	61	62	63	64

Terminal No.	Color of Wire	Signal Name
45	Y	IT DISP
46	P	CAN-L
47	P	M-CAN L
60	SHIELD	SHIELD
61	BR	DISP IT
62	L	CAN-H
63	L	M-CAN H

Connector No.	M156
Connector Name	AV CONTROL UNIT (WITHOUT NAVI)
Connector Color	WHITE



91	90	89	88	87	86	85	84	83	82	81	80	79	78	77	76
107	106	105	104	103	102	101	100	99	98	97	96	95	94	93	92

Terminal No.	Color of Wire	Signal Name
86	L	CAN-H
87	P	CAN-L
88	L	M-CAN H
89	P	M-CAN L

ABLIA2622GB

# REAR WINDOW DEFOGGER

< WIRING DIAGRAM >

Connector No.	B4
Connector Name	FUSE BLOCK (J/B)
Connector Color	BROWN

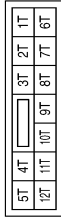

Terminal No.	Color of Wire	Signal Name
10T	Y	-
11T	Y	-

Terminal No.	82G	Color of Wire	LG	Signal Name	-
--------------	-----	---------------	----	-------------	---

Connector No.	E30
Connector Name	WIRE TO WIRE
Connector Color	WHITE

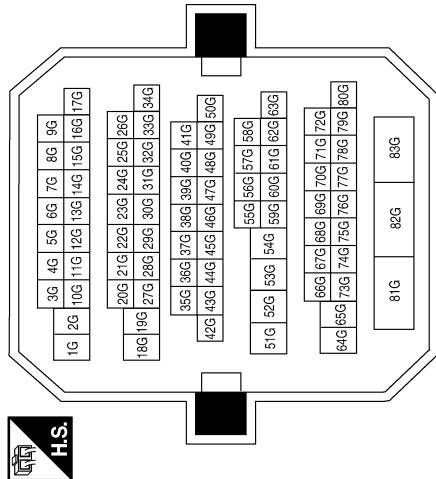

Connector No.	B54
Connector Name	REAR WINDOW DEFOGGER
Connector Color	BLACK



Terminal No.	Color of Wire	Signal Name
2	B	-

Connector No.	B53
Connector Name	REAR WINDOW DEFOGGER
Connector Color	BLACK



Terminal No.	Color of Wire	Signal Name
1	B	-

Connector No.	B52
Connector Name	REAR WINDOW DEFOGGER CONDENSER
Connector Color	WHITE



Terminal No.	Color of Wire	Signal Name
1	Y	-

ABLIA2623GB

A  
B  
C  
D  
E  
F  
G  
H  
I  
J  
K  
DEF  
M  
N  
O  
P

# REAR WINDOW DEFOGGER

< WIRING DIAGRAM >

Connector No.	D4
Connector Name	DOOR MIRROR LH
Connector Color	WHITE

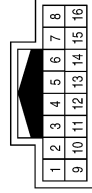

Terminal No.	Color of Wire	Signal Name
5	O	HEATER (+)
13	B	HEATER GND

Connector No.	D2
Connector Name	WIRE TO WIRE
Connector Color	WHITE

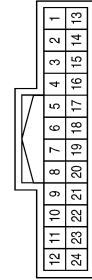

Terminal No.	Color of Wire	Signal Name
19	O	-

Connector No.	D1
Connector Name	WIRE TO WIRE
Connector Color	WHITE

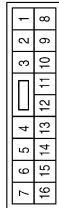

Terminal No.	Color of Wire	Signal Name
10	B	-

Connector No.	D107
Connector Name	DOOR MIRROR RH
Connector Color	WHITE

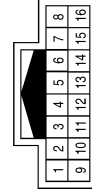

Terminal No.	Color of Wire	Signal Name
5	O	HEATER (+)
13	B	HEATER GND

Connector No.	D102
Connector Name	WIRE TO WIRE
Connector Color	WHITE

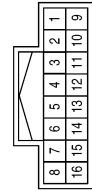

Terminal No.	Color of Wire	Signal Name
4	O	-

Connector No.	D101
Connector Name	WIRE TO WIRE
Connector Color	WHITE

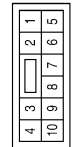

Terminal No.	Color of Wire	Signal Name
6	B	-

ABLIA2624GB

# REAR WINDOW DEFOGGER

< WIRING DIAGRAM >

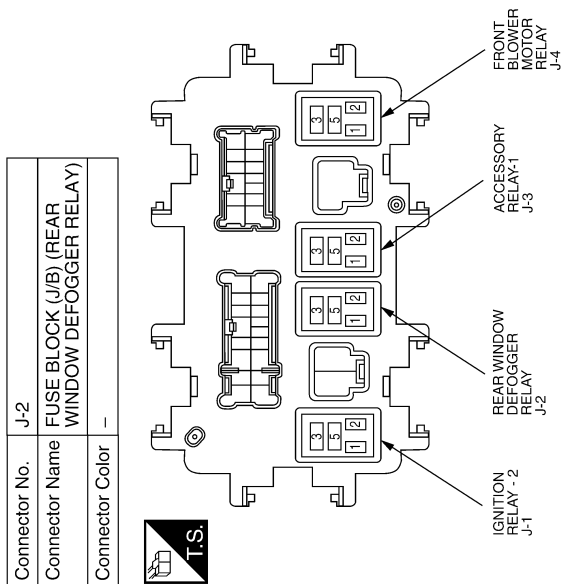

A  
B  
C  
D  
E  
F  
G  
H  
I  
J  
K  
DEF  
M  
N  
O  
P

ABLIA4034GB

# REAR WINDOW DEFOGGER AND DOOR MIRROR DEFOGGER DO NOT OPERATE.

< SYMPTOM DIAGNOSIS >

## SYMPTOM DIAGNOSIS

REAR WINDOW DEFOGGER AND DOOR MIRROR DEFOGGER DO NOT OPERATE.

### Diagnosis Procedure

INFOID:000000007252918

Regarding Wiring Diagram information, refer to [DEF-47. "Wiring Diagram"](#).

#### 1. CHECK REAR WINDOW DEFOGGER SWITCH

Check rear window defogger switch.

Refer to [DEF-11. "Component Function Check"](#).

Is the inspection result normal?

YES >> GO TO 2

NO >> Repair or replace the malfunctioning parts.

#### 2. CHECK REAR WINDOW DEFOGGER RELAY

Check rear window defogger relay.

Refer to [DEF-13. "Component Function Check"](#).

Is the inspection result normal?

YES >> GO TO 3

NO >> Repair or replace the malfunctioning parts.

#### 3. CHECK FUSES

Check if any of the following fuses in fuse block (J/B) are blown.

COMPONENT PARTS	AMPERE	FUSE NO.
Fuse block (J/B)	20A	14
	20A	15

Is the inspection result normal?

YES >> GO TO 4

NO >> If fuse is blown, be sure to eliminate cause of malfunction before installing new fuse.

#### 4. CHECK REAR WINDOW DEFOGGER POWER SUPPLY CIRCUIT

1. Turn ignition switch ON.

2. Check voltage between fuse block (J/B) connector and ground.

Terminals		Condition of rear window defogger switch	Voltage (V) (Approx.)
(+)	(-)		
Fuse block (J/B) connector	Terminal		
B4	10T, 11T	Ground	Battery voltage
			0

Is the inspection result normal?

YES >> GO TO 5

NO >> Replace fuse block (J/B).

#### 5. CHECK REAR WINDOW DEFOGGER POWER SUPPLY AND GROUND CIRCUIT

Check rear window defogger power supply and ground circuit.

Refer to [DEF-15. "Component Function Check"](#).

Is the inspection result normal?

YES >> GO TO 6



# REAR WINDOW DEFOGGER AND DOOR MIRROR DEFOGGER DO NOT OPERATE.

## < SYMPTOM DIAGNOSIS >

---

NO >> Repair or replace the malfunctioning parts.

### 6. CHECK DOOR MIRROR DEFOGGER

---

Check door mirror defogger.

Refer to [DEF-59, "Diagnosis Procedure"](#).

Is the inspection result normal?

YES >> Check intermittent incident. Refer to [GI-39, "Intermittent Incident"](#).

NO >> Repair or replace the malfunctioning parts.

A  
B  
C  
D  
E  
F  
G  
H  
I  
J  
K  
DEF  
M  
N  
O  
P

# REAR WINDOW DEFOGGER DOES NOT OPERATE BUT BOTH OF DOOR MIRROR DEFOGGER OPERATE.

< SYMPTOM DIAGNOSIS >

---

REAR WINDOW DEFOGGER DOES NOT OPERATE BUT BOTH OF DOOR MIRROR DEFOGGER OPERATE.

## Diagnosis Procedure

INFOID:000000007252919

### 1. CHECK REAR WINDOW DEFOGGER POWER SUPPLY AND GROUND CIRCUIT

---

Check rear window defogger power supply and ground circuit.

Refer to [DEF-15, "Component Function Check"](#).

Is the inspection result normal?

YES >> Refer to [GI-39, "Intermittent Incident"](#).

NO >> Repair or replace the malfunctioning parts.

# BOTH DOORS MIRROR DEFOGGER DON'T OPERATE BUT REAR WINDOW DEFOGGER OPERATES

< SYMPTOM DIAGNOSIS >

## BOTH DOORS MIRROR DEFOGGER DON'T OPERATE BUT REAR WINDOW DEFOGGER OPERATES

### Diagnosis Procedure

INFOID:000000007252920

Regarding Wiring Diagram information, refer to [DEF-47, "Wiring Diagram"](#).

### 1. CHECK DOOR MIRROR DEFORGGER FUSE

Check if the following fuse in fuse block (J/B) is blown.

COMPONENT PARTS	AMPERE	FUSE NO.
Fuse block (J/B)	10A	13

Is the inspection result normal?

YES >> GO TO 2

NO >> Replace the blown fuse after repairing the affected circuit.

### 2. CHECK DOOR MIRROR DEFORGGER CIRCUIT

- Turn ignition switch OFF.
- Disconnect the following harness connectors.
  - Fuse block (J/B) connector M5
  - Door mirror LH D4
  - Door mirror RH D107
- Check continuity between fuse block (J/B) harness connector M5 and door mirror defogger harness connectors D4,D107.

Fuse block (J/B) Connector	Terminal	Door mirror Connectors	Terminal	Continuity
M5	10M	D4(LH)	5	YES
		D107(RH)		

- Check continuity between fuse block (J/B) harness connector M5 terminal 10M and ground.

Fuse block (J/B) connector	Terminal	Ground	Continuity
M5	10M		No

Is the inspection result normal?

YES >> GO TO 3.

NO >> Repair or replace harness.

### 3. CHECK DOOR MIRROR DEFOGGER

Check door mirror LH.

Refer to [DEF-17, "Component Function Check"](#).

Check door mirror RH.

Refer to [DEF-19, "Component Function Check"](#).

Is the inspection result normal?

YES >> Refer to [GI-39, "Intermittent Incident"](#).

NO >> Repair or replace the malfunctioning parts.

## DRIVER SIDE DOOR MIRROR DEFOGGER DOES NOT OPERATE.

< SYMPTOM DIAGNOSIS >

---

## DRIVER SIDE DOOR MIRROR DEFOGGER DOES NOT OPERATE.

### Diagnosis Procedure

INFOID:000000007252921

#### 1. CHECK DOOR MIRROR DEFOGGER LH

---

Check door mirror defogger LH.

Refer to [DEF-17, "Component Function Check"](#).

Is the inspection result normal?

YES >> Refer to [GI-39, "Intermittent Incident"](#).

NO >> Repair or replace the malfunctioning parts.

# PASSENGER SIDE DOOR MIRROR DEFOGGER DOES NOT OPERATE.

< SYMPTOM DIAGNOSIS >

## PASSENGER SIDE DOOR MIRROR DEFOGGER DOES NOT OPERATE.

### Diagnosis Procedure

INFOID:000000007252922

#### 1. CHECK DOOR MIRROR DEFOGGER RH

Check door mirror defogger RH.

Refer to [DEF-19, "Component Function Check"](#).

Is the inspection result normal?

YES >> Refer to [GI-39, "Intermittent Incident"](#).

NO >> Repair or replace the malfunctioning parts.

A  
B  
C  
D  
E  
F  
G  
H  
I  
J  
K  
DEF  
M  
N  
O  
P

# REAR WINDOW DEFOGGER SWITCH DOES NOT LIGHT, BUT REAR WINDOW DEFOGGER OPERATES

< SYMPTOM DIAGNOSIS >

---

## REAR WINDOW DEFOGGER SWITCH DOES NOT LIGHT, BUT REAR WINDOW DEFOGGER OPERATES

### Diagnosis Procedure

INFOID:000000007252923

#### 1. CHECK A/C AUTO AMP. (REAR WINDOW DEFOGGER SWITCH)

---

Check that A/C auto amp. (rear window defogger switch) is operating normally.

Is the inspection result normal?

- YES >> Refer to [GI-39, "Intermittent Incident"](#).
- NO >> Refer to [DEF-11, "Diagnosis Procedure"](#).

# PRECAUTIONS

< PRECAUTION >

## PRECAUTION

### PRECAUTIONS

#### Precaution for Supplemental Restraint System (SRS) "AIR BAG" and "SEAT BELT PRE-TENSIONER"

INFOID:000000007252924

The Supplemental Restraint System such as "AIR BAG" and "SEAT BELT PRE-TENSIONER", used along with a front seat belt, helps to reduce the risk or severity of injury to the driver and front passenger for certain types of collision. This system includes seat belt switch inputs and dual stage front air bag modules. The SRS system uses the seat belt switches to determine the front air bag deployment, and may only deploy one front air bag, depending on the severity of a collision and whether the front occupants are belted or unbelted. Information necessary to service the system safely is included in the SR and SB section of this Service Manual.

#### **WARNING:**

- To avoid rendering the SRS inoperative, which could increase the risk of personal injury or death in the event of a collision which would result in air bag inflation, all maintenance must be performed by an authorized NISSAN/INFINITI dealer.
- Improper maintenance, including incorrect removal and installation of the SRS, can lead to personal injury caused by unintentional activation of the system. For removal of Spiral Cable and Air Bag Module, see the SR section.
- Do not use electrical test equipment on any circuit related to the SRS unless instructed to in this Service Manual. SRS wiring harnesses can be identified by yellow and/or orange harnesses or harness connectors.

#### PRECAUTIONS WHEN USING POWER TOOLS (AIR OR ELECTRIC) AND HAMMERS

#### **WARNING:**

- When working near the Airbag Diagnosis Sensor Unit or other Airbag System sensors with the Ignition ON or engine running, DO NOT use air or electric power tools or strike near the sensor(s) with a hammer. Heavy vibration could activate the sensor(s) and deploy the air bag(s), possibly causing serious injury.
- When using air or electric power tools or hammers, always switch the Ignition OFF, disconnect the battery, and wait at least 3 minutes before performing any service.

#### Precaution for Work

INFOID:000000007252925

- When removing or disassembling each component, be careful not to damage or deform it. If a component may be subject to interference, be sure to protect it with a shop cloth.
- When removing (disengaging) components with a screwdriver or similar tool, be sure to wrap the component with a shop cloth or vinyl tape to protect it.
- Protect the removed parts with a shop cloth and prevent them from being dropped.
- Replace a deformed or damaged clip.
- If a part is specified as a non-reusable part, always replace it with new one.
- Be sure to tighten bolts and nuts securely to the specified torque.
- After installation is complete, be sure to check that each part works properly.
- Follow the steps below to clean components.
  - Water soluble dirt: Dip a soft cloth into lukewarm water, and wring the water out of the cloth to wipe the dirty area.  
Then rub with a soft and dry cloth.
  - Oily dirt: Dip a soft cloth into lukewarm water with mild detergent (concentration: within 2 to 3%), and wipe the dirty area.  
Then dip a cloth into fresh water, and wring the water out of the cloth to wipe the detergent off. Then rub with a soft and dry cloth.
- Do not use organic solvent such as thinner, benzene, alcohol, or gasoline.
- For genuine leather seats, use a genuine leather seat cleaner.

A  
B  
C  
D  
E  
F  
G  
H  
I  
J  
K  
DEF  
M  
N  
O  
P

# PREPARATION

< PREPARATION >

## PREPARATION

### PREPARATION

#### Special Service Tool

INFOID:000000007252926

The actual shapes of Kent-Moore tools may differ from those of special service tools illustrated here.

Tool number (Kent-Moore No.) Tool name	Description
— (J-46534) Trim Tool Set	Removing trim components

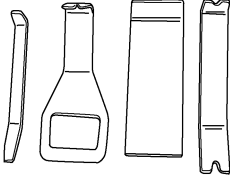

AWJIA04832Z

#### Commercial Service Tool

INFOID:000000007252927

Tool name	Description
Power tool	Loosening nuts, screws and bolts



PIIB1407E



# FILAMENT

< REMOVAL AND INSTALLATION >

## REMOVAL AND INSTALLATION

### FILAMENT

#### Inspection and Repair

INFOID:000000007252928

#### INSPECTION

1. When measuring voltage, wrap tin foil around the top of the negative probe. Then press the foil against the wire with your finger.

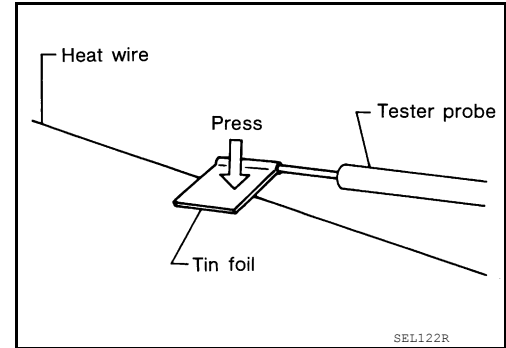

2. Attach probe circuit tester (in Volt range) to middle portion of each filament.

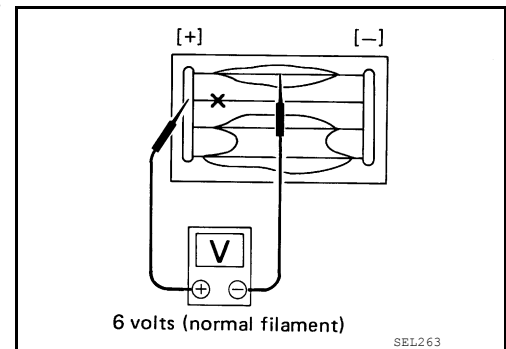

3. If a filament is burned out, circuit tester registers zero or battery voltage.
4. To locate burned out point, move probe to left and right along filament. Test needle will swing abruptly when probe passes the point.

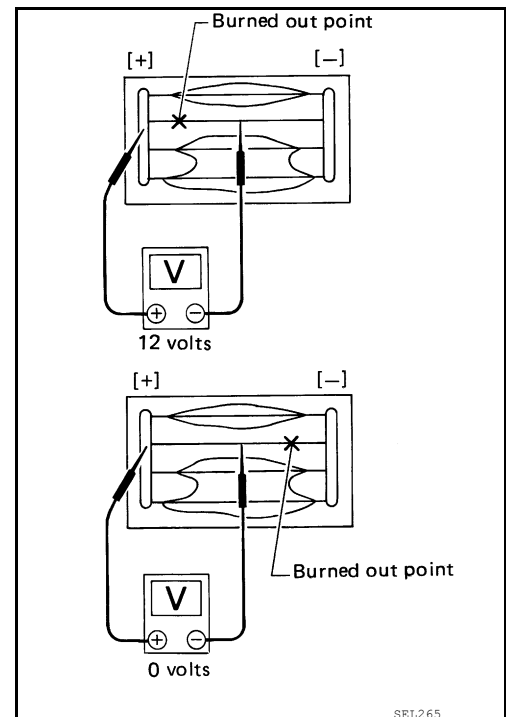

#### REPAIR

#### REPAIR EQUIPMENT

- Conductive silver composition (Dupont No. 4817 or equivalent)

A  
B  
C  
D  
E  
F  
G  
H  
I  
J  
K  
DEF  
M  
N  
O  
P

# FILAMENT

## < REMOVAL AND INSTALLATION >

- Ruler 30 cm (11.8 in) long
- Drawing pen
- Heat gun
- Alcohol
- Cloth

### REPAIRING PROCEDURE

1. Wipe broken heat wire and its surrounding area clean with a cloth dampened in alcohol.
2. Apply a small amount of conductive silver composition to tip of drawing pen. Shake silver composition container before use.
3. Place ruler on glass along broken line. Deposit conductive silver composition on break with drawing pen. Slightly overlap existing heat wire on both sides [preferably 5 mm (0.20 in)] of the break.

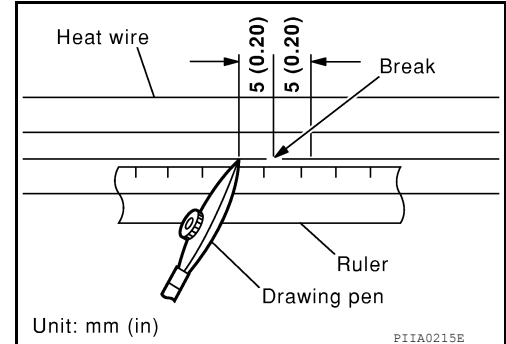

4. After repair has been completed, check repaired wire for continuity. This check should be conducted 10 minutes after silver composition is deposited. Do not touch repaired area while test is being conducted.

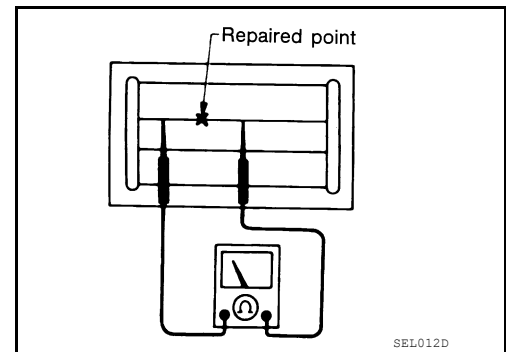

5. Apply a constant stream of hot air directly to the repaired area for approximately 20 minutes with a heat gun. A minimum distance of 3 cm (1.2 in) should be kept between repaired area and hot air outlet. If a heat gun is not available, let the repaired area dry for 24 hours.

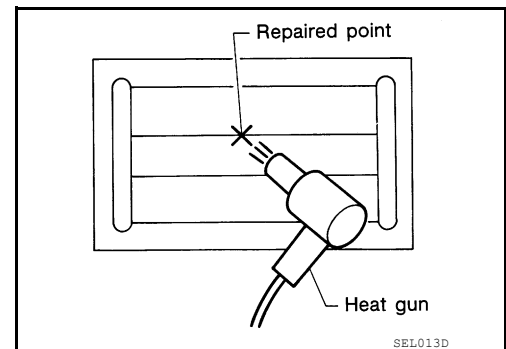

# CONDENSER

< REMOVAL AND INSTALLATION >

## CONDENSER

### Removal and Installation

INFOID:000000007252929

#### REMOVAL

1. Remove the rear pillar finisher LH. Refer to [INT-24. "Removal and Installation"](#).
2. Disconnect the electrical connector, remove bolt (A), and then remove condenser (1) from the vehicle body.

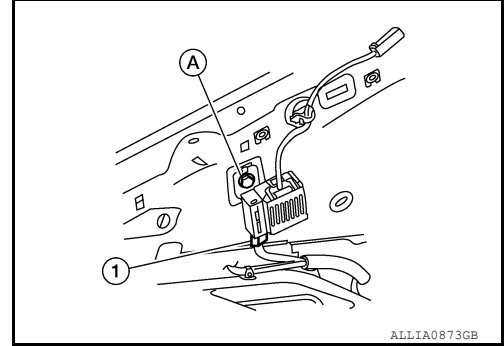

#### INSTALLATION

Installation is in the reverse order of removal.

A  
B  
C  
D  
E  
F  
G  
H  
I  
J  
K  
DEF  
M  
N  
O  
P