

CONTROL UNITS

SMART ENTRANCE CONTROL UNIT



View from harness side



View from harness side



View from harness side

AIRBAG DIAGNOSIS SENSOR UNIT



View from harness side

ABS CONTROL UNIT

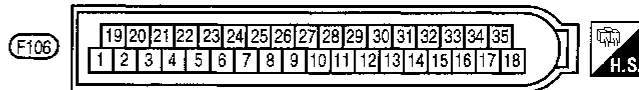

View from harness side

A/T CONTROL UNIT

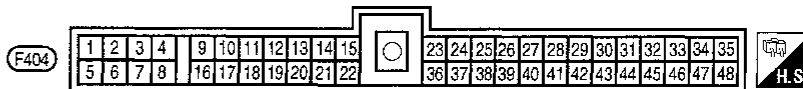

View from harness side

ECM (ECCS CONTROL MODULE)

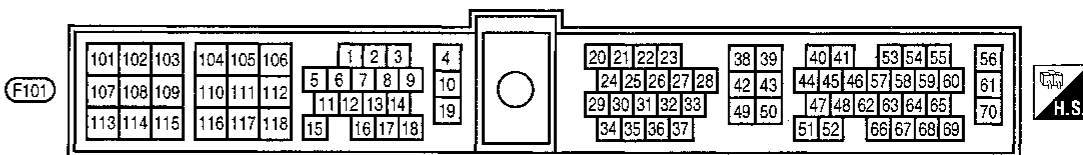

View from harness side

SUPER MULTIPLE JUNCTION (SMJ)

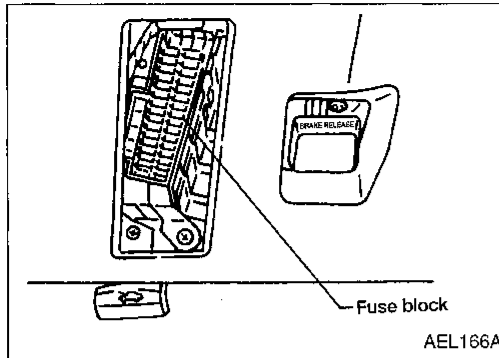

INSTALLATION

To install SMJ, tighten bolts until orange "fulltight" mark appears and then retighten to specified torque as required.

: 3 - 5 N·m
(0.3 - 0.5 kg-m, 26 - 43 in-lb)

CAUTION:

Do not overtighten bolts, otherwise, they may be damaged.

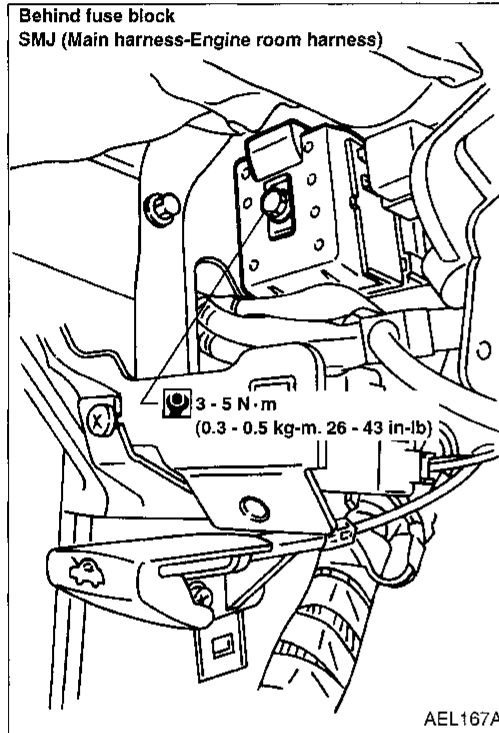

SUPER MULTIPLE JUNCTION (SMJ)

Terminal Arrangement

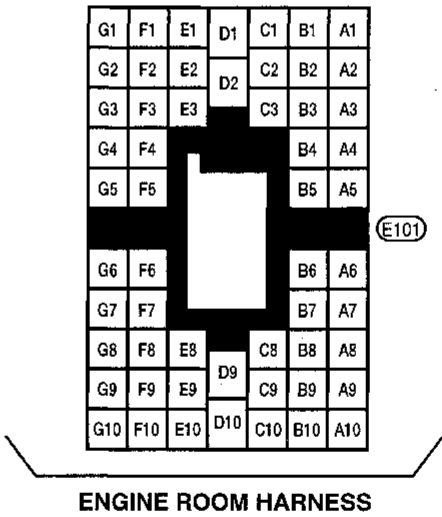
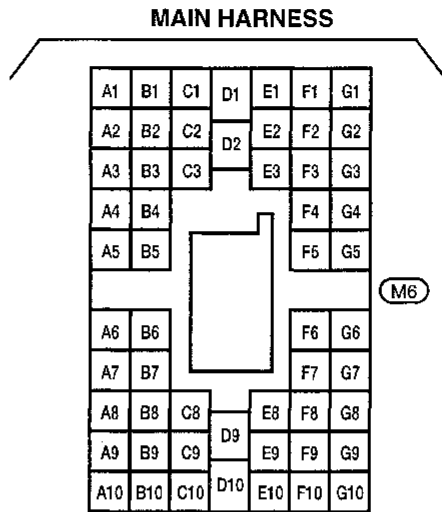

JOINT CONNECTOR (J/C)

Location

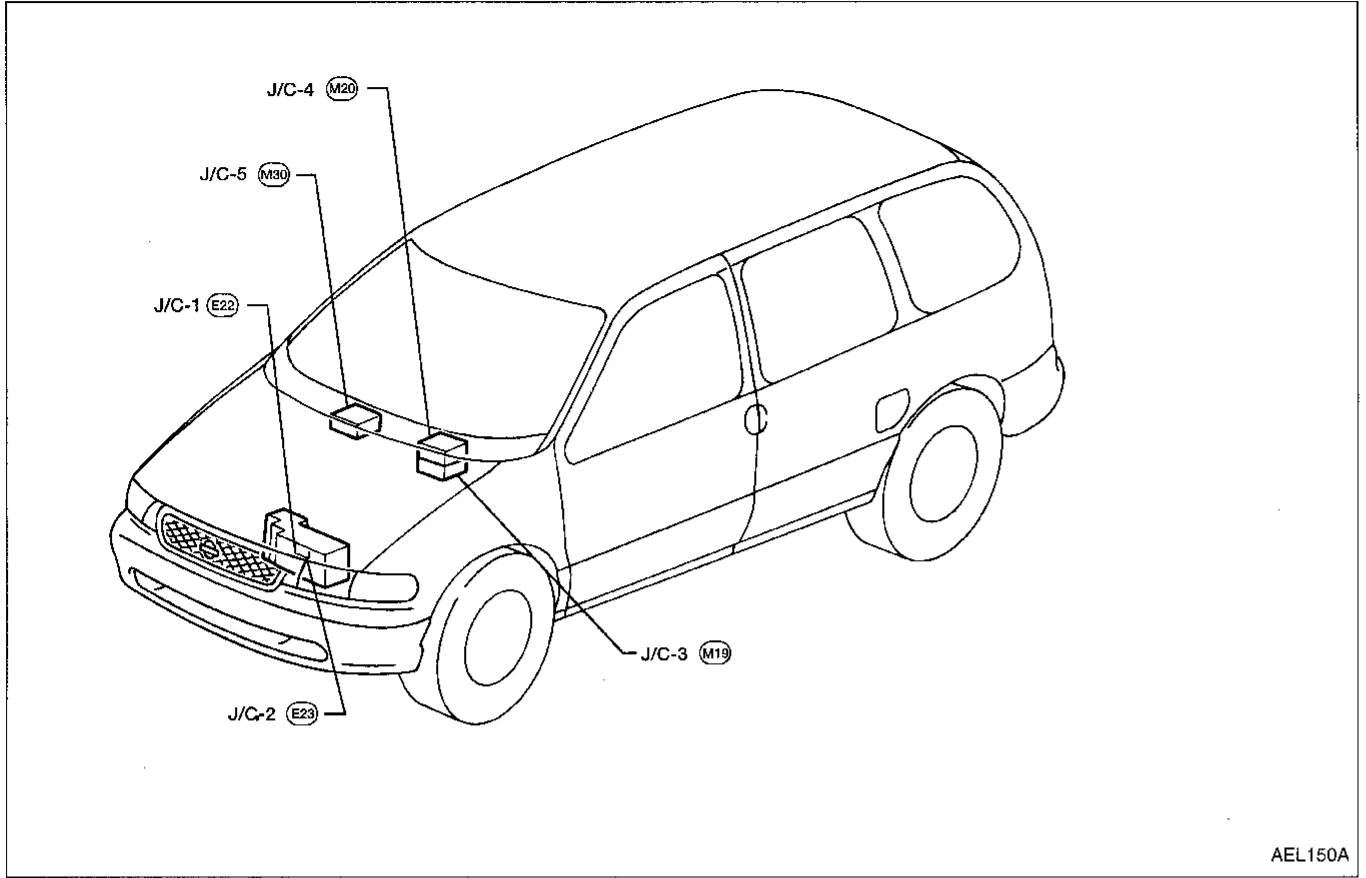

AEL150A

Terminal Arrangement

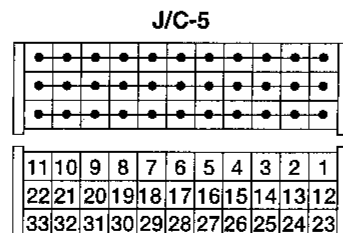
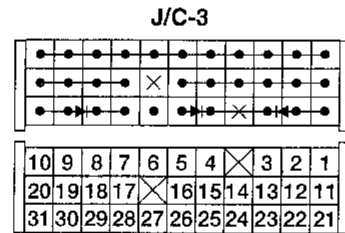
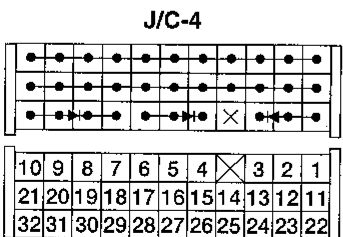
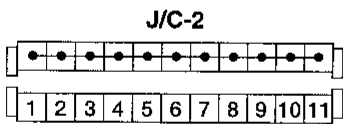
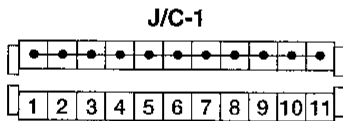

AEL151A