

# SECTION LAN

## LAN SYSTEM

### CONTENTS

<b>CAN FUNDAMENTAL</b>		
<b>SERVICE INFORMATION</b> .....	2	
<b>PRECAUTIONS</b> .....	2	
Precaution for Trouble Diagnosis .....	2	
Precaution for Harness Repair .....	2	
<b>SYSTEM DESCRIPTION</b> .....	3	
CAN Communication System .....	3	
Diag on CAN .....	4	
<b>TROUBLE DIAGNOSIS</b> .....	6	
Condition of Error Detection .....	6	
Symptom When Error Occurs in CAN Communi- cation System .....	6	
Self-Diagnosis .....	9	
CAN Diagnostic Support Monitor .....	9	
<b>TROUBLE DIAGNOSES WORK FLOW</b> .....	12	
Information Needed for Trouble Diagnosis .....	12	
How to Use CAN Communication Signal Chart .....	12	
Trouble Diagnosis Flow Chart .....	13	
Trouble Diagnosis Procedure .....	13	
<b>CAN</b>		
<b>SERVICE INFORMATION</b> .....	35	
<b>INDEX FOR DTC</b> .....	35	
DTC No. Index .....	35	
<b>HOW TO USE THIS SECTION</b> .....	36	
Caution .....	36	
Abbreviation List .....	36	
<b>PRECAUTIONS</b> .....	37	
		Precaution for Supplemental Restraint System (SRS) "AIR BAG" and "SEAT BELT PRE-TEN- SIONER" .....
		37
		Precaution for Trouble Diagnosis .....
		37
		Precaution for Harness Repair .....
		37
<b>TROUBLE DIAGNOSIS</b> .....	38	
CAN Diagnostic Support Monitor .....	38	
CAN System Specification Chart .....	41	
CAN Communication Signal Chart .....	42	
Schematic .....	47	
Wiring Diagram - CAN - .....	48	
Interview Sheet .....	51	
Data Sheet .....	51	
CAN System (Type 1) .....	53	
CAN System (Type 2) .....	54	
CAN System (Type 3) .....	55	
Component Parts Location .....	56	
Harness Layout .....	56	
Malfunction Area Chart .....	56	
Main Line Between TCM and Data Link Connector .....	57	
ECM Branch Line Circuit .....	58	
ABS Actuator and Electric Unit (Control Unit) Branch Line Circuit .....	58	
TCM Branch Line Circuit .....	59	
Driver Seat Control Unit Branch Line Circuit .....	59	
BCM Branch Line Circuit .....	60	
Display Control Unit Branch Line Circuit .....	61	
Display Unit Branch Line Circuit .....	61	
Data Link Connector Branch Line Circuit .....	62	
Front Air Control Branch Line Circuit .....	62	
Combination Meter Branch Line Circuit .....	63	
Steering Angle Sensor Branch Line Circuit .....	64	
IPDM E/R Branch Line Circuit .....	64	
CAN Communication Circuit .....	65	

## SERVICE INFORMATION

### PRECAUTIONS

#### Precaution for Trouble Diagnosis

INFOID:000000003032415

**CAUTION:**

- Never apply 7.0 V or more to the measurement terminal.
- Use a tester with open terminal voltage of 7.0 V or less.
- Turn the ignition switch OFF and disconnect the battery cable from the negative terminal when checking the harness.

#### Precaution for Harness Repair

INFOID:000000003032416

- Solder the repaired area and wrap tape around the soldered area.

**NOTE:**

A fray of twisted lines must be within 110 mm (4.33 in).

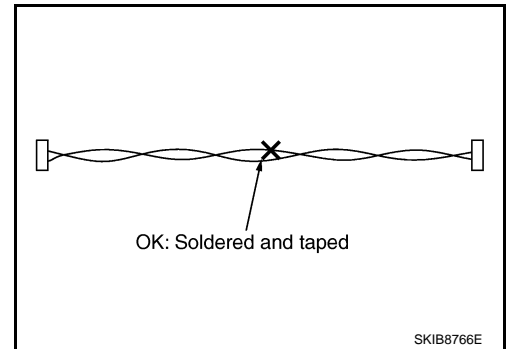

- Bypass connection is never allowed at the repaired area.

**NOTE:**

Bypass connection may cause CAN communication error. The spliced wire becomes separated and the characteristics of twisted line are lost.

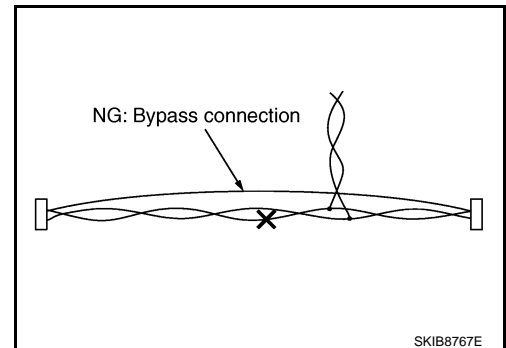

- Replace the applicable harness as an assembly if error is detected on the shield lines of CAN communication line.

SYSTEM DESCRIPTION

CAN Communication System

INFOID:000000003032417

- CAN communication is a multiplex communication system. This enables the system to transmit and receive large quantities of data at high speed by connecting control units with two communication lines (CAN-H and CAN-L).
- Control units on the CAN network transmit signals using the CAN communication control circuit. They receive only necessary signals from other control units to operate various functions.
- CAN communication lines adopt twisted-pair line style (two lines twisted) for noise immunity.

SYSTEM DIAGRAM

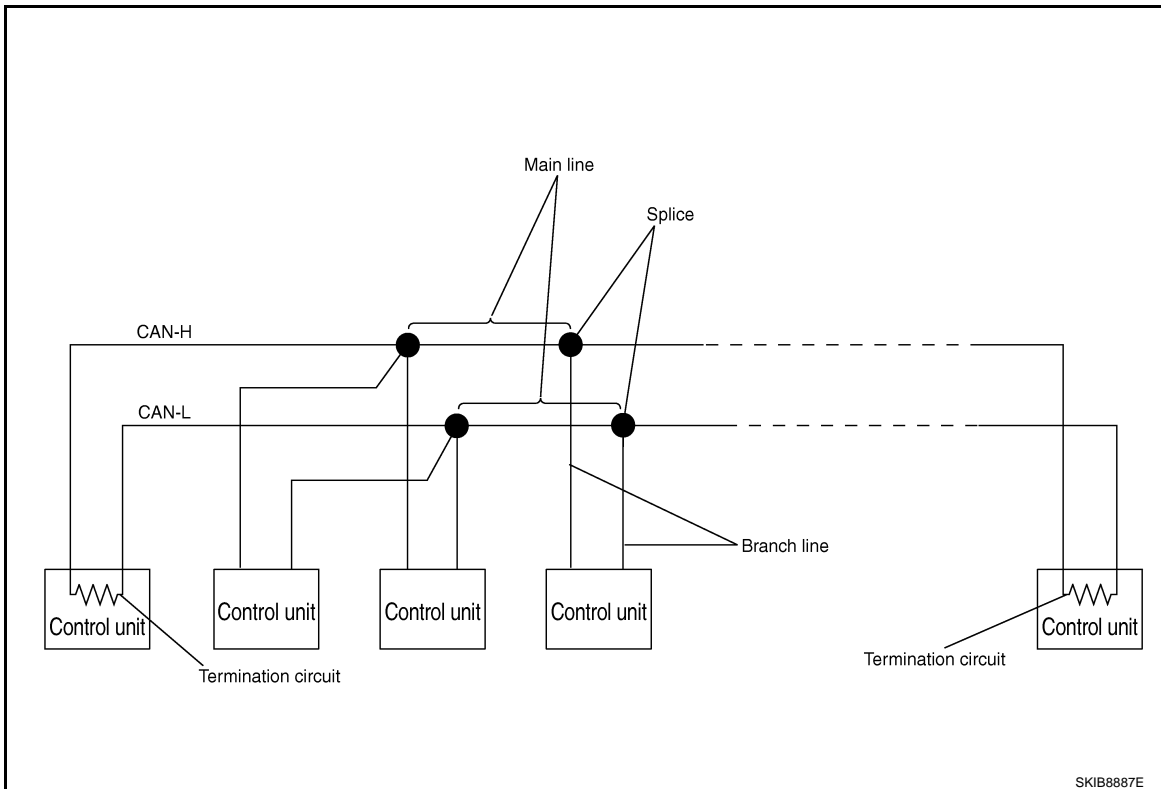

Each control unit passes an electric current to the termination circuits when transmitting CAN communication signal. The termination circuits produce an electrical potential difference between CAN-H and CAN-L. CAN communication system transmits and receives CAN communication signals by the potential difference.

Component	Description
Main line	CAN communication line between splices
Branch line	CAN communication line between splice and a control unit
Splice	A point connecting a branch line with a main line
Termination circuit	Refer to "CAN COMMUNICATION CONTROL CIRCUIT".

A  
B  
C  
D  
E  
F  
G  
H  
I  
J  
LAN  
L  
M  
N  
O  
P

# SYSTEM DESCRIPTION

< SERVICE INFORMATION >

[CAN FUNDAMENTAL]

## CAN COMMUNICATION CONTROL CIRCUIT

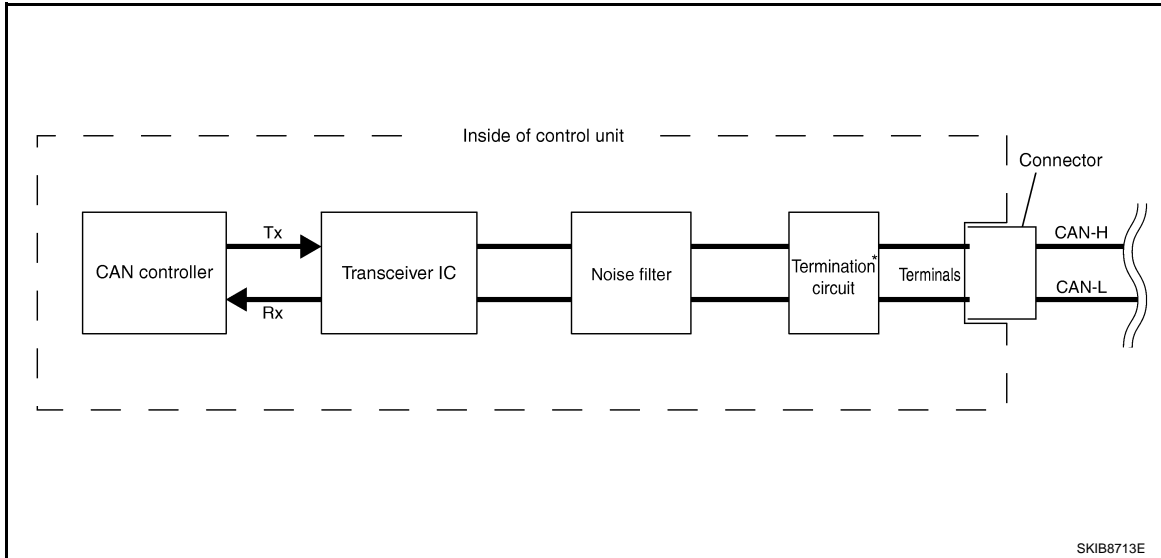

Component	System description
CAN controller	It controls CAN communication signal transmission and reception, error detection, etc.
Transceiver IC	It converts digital signal into CAN communication signal, and CAN communication signal into digital signal.
Noise filter	It eliminates noise of CAN communication signal.
Termination circuit* (Resistance of approx. 120 Ω)	It produces potential difference.

\*: These are the only control units wired with both ends of CAN communication system.

## Diag on CAN

INFOID:000000003032418

### DESCRIPTION

“Diag on CAN” is a diagnosis using CAN communication instead of previous DDL1 and DDL2 communication lines, between control units and diagnosis unit.

# SYSTEM DESCRIPTION

< SERVICE INFORMATION >

[CAN FUNDAMENTAL]

## System Diagram

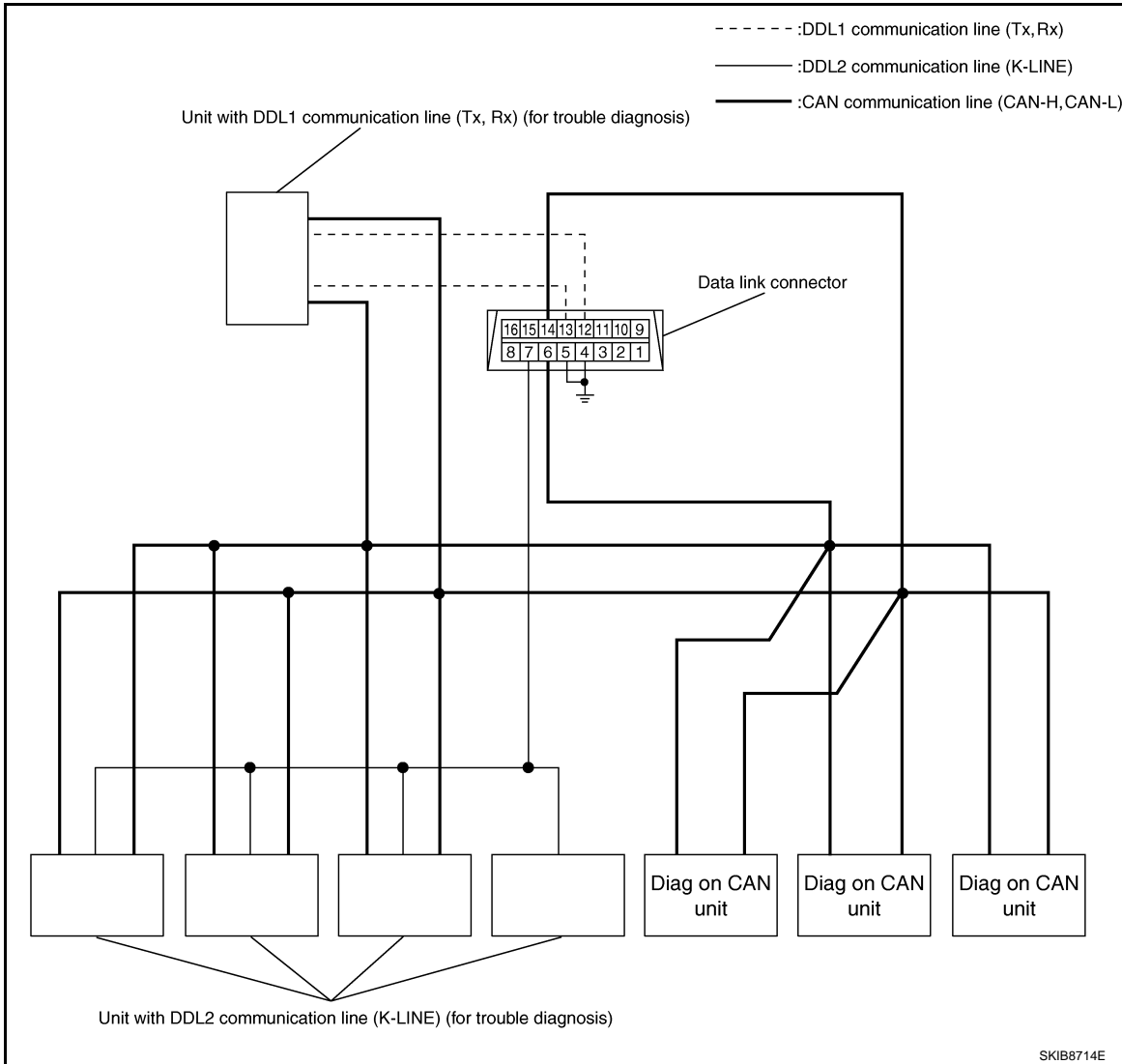

Name	Harness	Description
DDL1	Tx Rx	It is used for trouble diagnosis. (CAN-H and CAN-L are used for controlling)
DDL2	K-LINE	It is used for trouble diagnosis. (CAN-H and CAN-L are used for controlling)
Diag on CAN	CAN-H CAN-L	It is used for trouble diagnosis and control.

A  
B  
C  
D  
E  
F  
G  
H  
I  
J  
L  
M  
N  
O  
P

LAN

## TROUBLE DIAGNOSIS

### Condition of Error Detection

INFOID:000000003032419

“U1000” or “U1001” is indicated on SELF-DIAG RESULTS on CONSULT-III if CAN communication signal is not transmitted or received between units for 2 seconds or more.

#### CAN COMMUNICATION SYSTEM ERROR

- CAN communication line open (CAN-H, CAN-L, or both)
- CAN communication line short (ground, between CAN communication lines, other harnesses)
- Error of CAN communication control circuit of the unit connected to CAN communication line

#### WHEN “U1000” OR “U1001” IS INDICATED EVEN THOUGH CAN COMMUNICATION SYSTEM IS NORMAL

- Removal/installation of parts: Error may be detected when removing and installing CAN communication unit and related parts while turning the ignition switch ON. (A DTC except for CAN communication may be detected.)
- Fuse blown out (removed): CAN communication of the unit may cease.
- Voltage drop: Error may be detected if voltage drops due to discharged battery when turning the ignition switch ON (Depending on the control unit which carries out CAN communication).
- Error may be detected if the power supply circuit of the control unit, which carries out CAN communication, malfunctions (Depending on the control unit which carries out CAN communication).
- Error may be detected if reprogramming is not completed normally.

**NOTE:**

CAN communication system is normal if “U1000” or “U1001” is indicated on SELF-DIAG RESULTS of CONSULT-III under the above conditions. Erase the memory of the self-diagnosis of each unit.

### Symptom When Error Occurs in CAN Communication System

INFOID:000000003032420

In CAN communication system, multiple units mutually transmit and receive signals. Each unit cannot transmit and receive signals if any error occurs on CAN communication line. Under this condition, multiple control units related to the root cause malfunction or go into fail-safe mode.

#### ERROR EXAMPLE

**NOTE:**

- Each vehicle differs in symptom of each unit under fail-safe mode and CAN communication line wiring.
- Refer to [LAN-36. "Abbreviation List"](#) for the unit abbreviation.

Example: TCM branch line open circuit

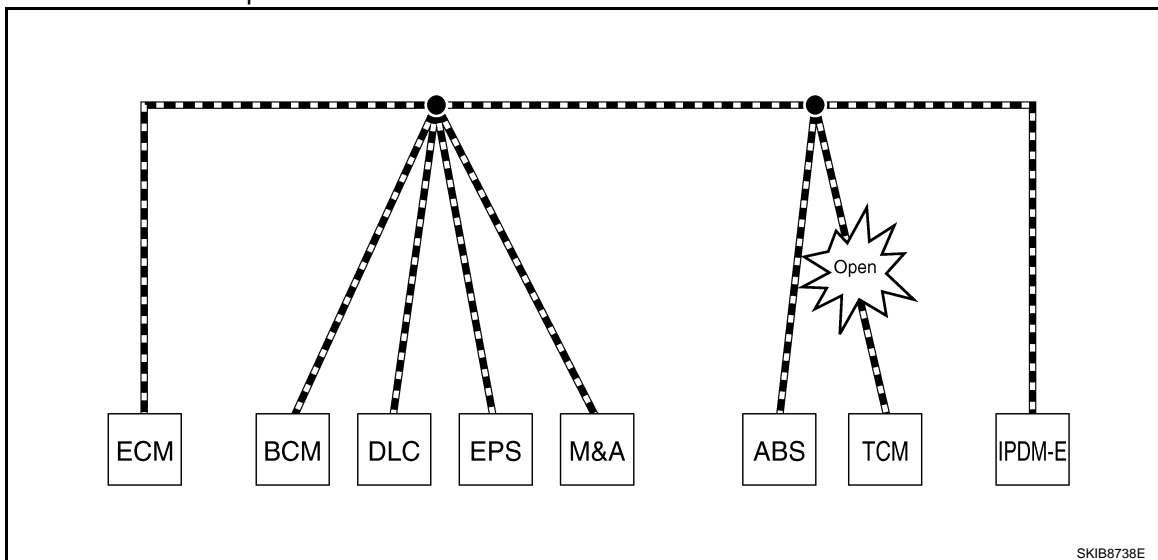

Unit name	Symptom
ECM	Engine torque limiting is affected, and shift harshness increases.
BCM	Reverse warning chime does not sound.

# TROUBLE DIAGNOSIS

< SERVICE INFORMATION >

[CAN FUNDAMENTAL]

Unit name	Symptom
EPS control unit	Normal operation.
Combination meter	<ul style="list-style-type: none"> <li>Shift position indicator and OD OFF indicator turn OFF.</li> <li>Warning lamps turn ON.</li> </ul>
ABS actuator and electric unit (control unit)	Normal operation.
TCM	No impact on operation.
IPDM E/R	Normal operation.

Example: Data link connector branch line open circuit

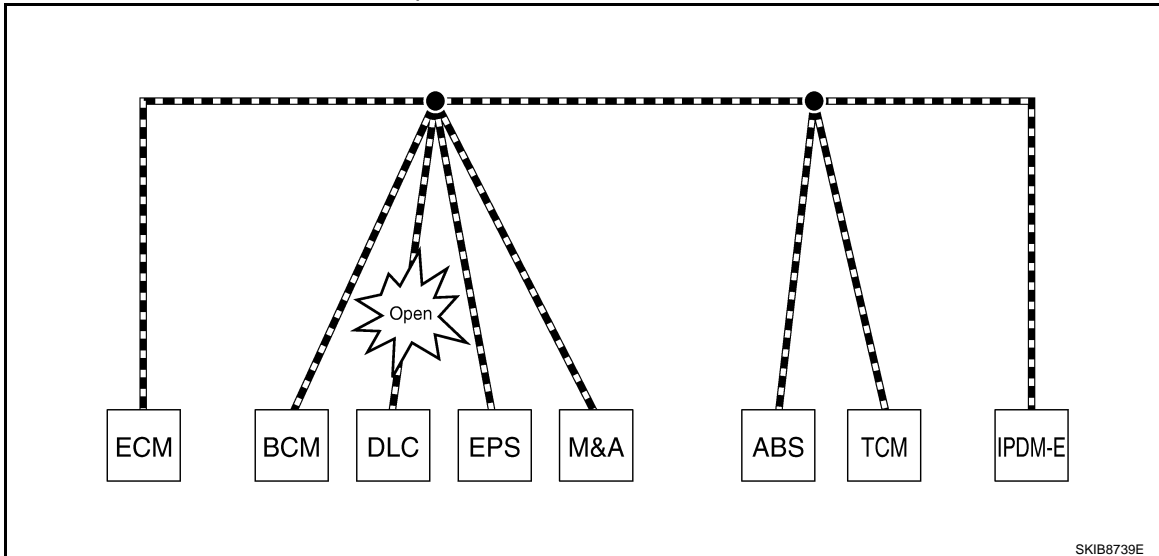

Unit name	Symptom
ECM	Normal operation.
BCM	
EPS control unit	
Combination meter	
ABS actuator and electric unit (control unit)	
TCM	
IPDM E/R	

**NOTE:**

- When data link connector branch line is open, transmission and reception of CAN communication signals are not affected. Therefore, no symptoms occur. However, be sure to repair malfunctioning circuit.
- When data link connector branch line is open, "ECU list" displayed on the CONSULT-III "CAN DIAG SUPPORT MNTR" may be the same as when the CAN communication line has short-circuit. However, symptoms differ depending on the case. See below chart for the differences.

	"ECU list" on the "CAN DIAG SUPPORT MNTR" (CONSULT-III)	Difference of symptom
Data link connector branch line open circuit		Normal operation.
CAN-H, CAN-L harness short-circuit	All Diag on CAN units are not indicated.	Most of the units which are connected to the CAN communication system enter fail-safe mode or are deactivated.

A  
B  
C  
D  
E  
F  
G  
H  
I  
J  
L  
M  
N  
O  
P

LAN

# TROUBLE DIAGNOSIS

< SERVICE INFORMATION >

[CAN FUNDAMENTAL]

Example: Main Line Between Data Link Connector and ABS Actuator and Electric Unit (Control Unit) Open Circuit

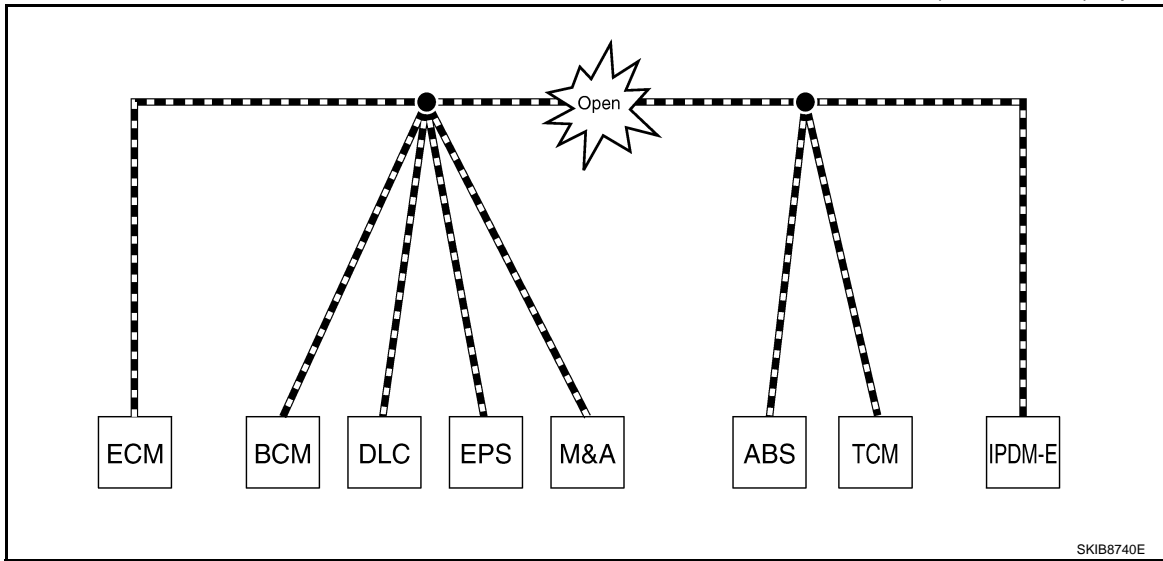

Unit name	Symptom
ECM	Engine torque limiting is affected, and shift harshness increases.
BCM	<ul style="list-style-type: none"> <li>• Reverse warning chime does not sound.</li> <li>• The front wiper moves under continuous operation mode even though the front wiper switch being in the intermittent position.</li> </ul>
EPS control unit	The steering effort increases.
Combination meter	<ul style="list-style-type: none"> <li>• The shift position indicator and OD OFF indicator turn OFF.</li> <li>• The speedometer is inoperative.</li> <li>• The odo/trip meter stops.</li> </ul>
ABS actuator and electric unit (control unit)	Normal operation.
TCM	No impact on operation.
IPDM E/R	When the ignition switch is ON, <ul style="list-style-type: none"> <li>• The headlamps (Lo) turn ON.</li> <li>• The cooling fan continues to rotate.</li> </ul>

Example: CAN-H, CAN-L Harness Short Circuit

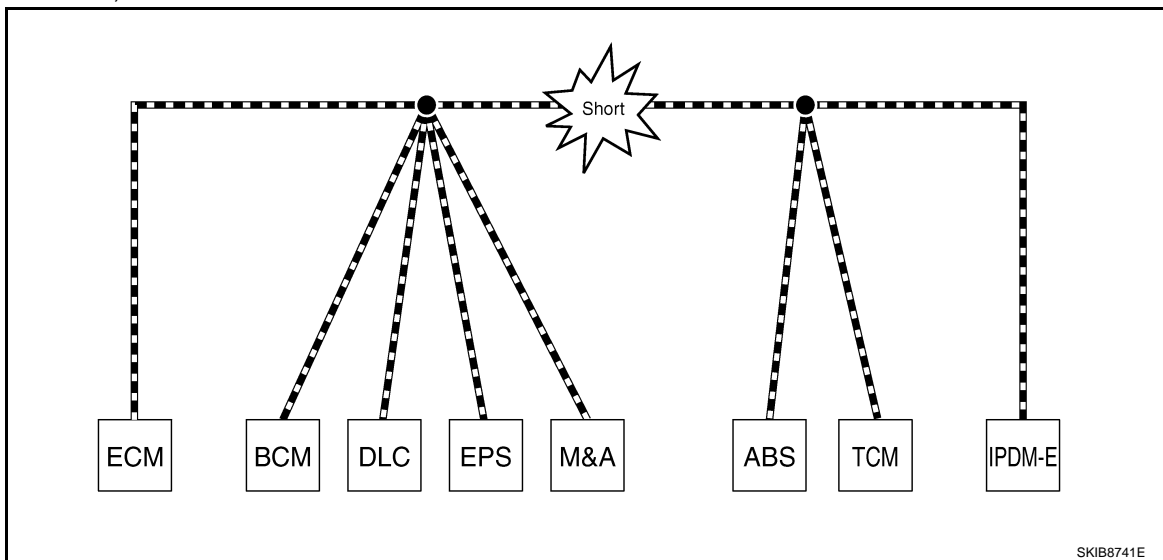



# TROUBLE DIAGNOSIS

< SERVICE INFORMATION >

[CAN FUNDAMENTAL]

Unit name	Symptom
ECM	<ul style="list-style-type: none"> <li>Engine torque limiting is affected, and shift harshness increases.</li> <li>Engine speed drops.</li> </ul>
BCM	<ul style="list-style-type: none"> <li>Reverse warning chime does not sound.</li> <li>The front wiper moves under continuous operation mode even though the front wiper switch being in the intermittent position.</li> <li>The room lamp does not turn ON.</li> <li>The engine does not start (if an error or malfunction occurs while turning the ignition switch OFF.)</li> <li>The steering lock does not release (if an error or malfunction occurs while turning the ignition switch OFF.)</li> </ul>
EPS control unit	The steering effort increases.
Combination meter	<ul style="list-style-type: none"> <li>The tachometer and the speedometer do not move.</li> <li>Warning lamps turn ON.</li> <li>Indicator lamps do not turn ON.</li> </ul>
ABS actuator and electric unit (control unit)	Normal operation.
TCM	No impact on operation.
IPDM E/R	When the ignition switch is ON, <ul style="list-style-type: none"> <li>The headlamps (Lo) turn ON.</li> <li>The cooling fan continues to rotate.</li> </ul>

## Self-Diagnosis

INFOID:000000003032421

DTC	Self-diagnosis item (CONSULT-III indication)	DTC detection condition	Inspection/Action
U1000	CAN COMM CIRCUIT	When ECM is not transmitting or receiving CAN communication signal of OBD (emission-related diagnosis) for 2 seconds or more.	Refer to <a href="#">LAN-12</a> .
		When a control unit (except for ECM) is not transmitting or receiving CAN communication signal for 2 seconds or more.	
U1001	CAN COMM CIRCUIT	When ECM is not transmitting or receiving CAN communication signal other than OBD (emission-related diagnosis) for 2 seconds or more.	
U1002	SYSTEM COMM	When a control unit is not transmitting or receiving CAN communication signal for 2 seconds or less.	Start the inspection. Refer to the applicable section of the indicated control unit.
U1010	CONTROL UNIT [CAN]	When an error is detected during the initial diagnosis for CAN controller of each control unit.	Replace the control unit indicating "U1010".

## CAN Diagnostic Support Monitor

INFOID:000000003032422

CONSULT-III and CAN diagnostic support monitor (on-board diagnosis function) are used for detecting root cause.

MONITOR ITEM (CONSULT-III)

# TROUBLE DIAGNOSIS

< SERVICE INFORMATION >

[CAN FUNDAMENTAL]

Example: CAN DIAG SUPPORT MNTR indication

Without PAST			With PAST		
ECM			ECM		
	PRSENT	PAST		PRSENT	PAST
INITIAL DIAG	OK		TRANSMIT DIAG	OK	OK
TRANSMIT DIAG	OK		VDC/TCS/ABS	-	-
TCM	OK		METER/M&A	OK	OK
VDC/TCS/ABS	UNKWN		BCM/SEC	OK	OK
METER/M&A	OK		ICC	-	-
ICC	UNKWN		HVAC	-	-
BCM/SEC	OK		TCM	OK	OK
IPDM E/R	OK		EPS	-	-
			IPDM E/R	OK	OK
			e4WD	-	-
			AWD/4WD	OK	OK

PKID1075E

Without PAST

Item	PRSENT	Description
Initial diagnosis	OK	Normal at present
	NG	Control unit error (Except for some control units)
Transmission diagnosis	OK	Normal at present
	UNKWN	Unable to transmit signals for 2 seconds or more. Diagnosis not performed
Control unit name (Reception diagnosis)	OK	Normal at present
	UNKWN	Unable to receive signals for 2 seconds or more. Diagnosis not performed
	UNKWN	No control unit for receiving signals. (No applicable optional parts)

With PAST

Item	PRSENT	PAST	Description
Transmission diagnosis	OK	OK	Normal at present and in the past
		1 – 39	Normal at present, but unable to transmit signals for 2 seconds or more in the past. (The number indicates the number of ignition switch cycles from OFF to ON.)
	UNKWN	0	Unable to transmit signals for 2 seconds or more at present.
Control unit name (Reception diagnosis)	OK	OK	Normal at present and in the past
		1 – 39	Normal at present, but unable to receive signals for 2 seconds or more in the past. (The number indicates the number of ignition switch cycles from OFF to ON.)
	UNKWN	0	Unable to receive signals for 2 seconds or more at present.
	-	-	Diagnosis not performed. No control unit for receiving signals. (No applicable optional parts)

## MONITOR ITEM (ON-BOARD DIAGNOSIS)

### NOTE:

- For some models, CAN communication diagnosis result is received from the vehicle monitor. (CONSULT-III is not available.)
- Refer to [LAN-38, "CAN Diagnostic Support Monitor"](#) for the details.

# TROUBLE DIAGNOSIS

< SERVICE INFORMATION >

[CAN FUNDAMENTAL]

Example: Vehicle Display

Item	Result indicated	Error counter	Description
CAN_COMM (Initial diagnosis)	OK	0	Normal at present
	NG	1 – 50	Control unit error (The number indicates how many times diagnosis has been run.)
CAN_CIRC_1 (Transmission diagnosis)	OK	0	Normal at present
	UNKWN	1 – 50	Unable to transmit for 2 seconds or more at present. (The number indicates how many times diagnosis has been run.)
CAN_CIRC_2 – 9 (Reception diagnosis of each unit)	OK	0	Normal at present
	UNKWN	1 – 50	Unable to transmit for 2 seconds or more at present. (The number indicates how many times diagnosis has been run.)
			Diagnosis not performed.
			No control unit for receiving signals. (No applicable optional parts)

A  
B  
C  
D  
E  
F  
G  
H  
I  
J  
L  
M  
N  
O  
P

LAN

# TROUBLE DIAGNOSES WORK FLOW

< SERVICE INFORMATION >

[CAN FUNDAMENTAL]

## TROUBLE DIAGNOSES WORK FLOW

### Information Needed for Trouble Diagnosis

INFOID:000000003032423

CAN communication system performs trouble diagnosis with the following tools.

Tool	Usage
Interview sheet	For filling in vehicle information and interview with customer.
Data sheet	For copying on-board diagnosis data.
Diagnosis sheet	For detecting the root cause. (Diagnosis sheet includes system diagram for every CAN system type)
ECU list (On the "CAN DIAG SUPPORT MNTR")	For checking the condition of control units and the status of CAN communication.
SELF-DIAG RESULTS (CONSULT-III)	
CAN DIAG SUPPORT MNTR (CONSULT-III)	
CAN communication signal chart	For converting information received from a customer into CAN communication signal transmission and reception. This information can be used to judge whether a circuit between control units is normal or abnormal.
Abbreviation list	For checking abbreviations in CAN communication signal chart and diagnosis sheet.

### How to Use CAN Communication Signal Chart

INFOID:000000003032424

The CAN communication signal chart lists the signals needed for trouble diagnosis. It is useful for detecting the root cause by finding a signal related to the symptom, and by checking transmission and reception unit.

Example: Tachometer does not move even though the engine rotates.

T: Transmit R: Receive

Signal name/Connecting unit	ECM	BCM	M&A	STRG	ABS	IPDM-E
A/C compressor feedback signal	T		R			
A/C compressor request signal	T					R
Accelerator pedal position signal	T				R	
Cooling fan motor operation signal	T					R
Engine coolant temperature signal	T		R			
Engine speed signal	T		R		R	
Fuel consumption monitor signal	T		R			
Malfunction indicator lamp signal	T		R			
A/C switch signal	R	T				
Ignition switch signal		T				R
Sleep/wake up signal		T	R			R

No communication between ECM and M&A.

It indicates that an error occurs between ECM and M&A (Shaded area).

CAN-H, CAN-L

SKI8715E

# TROUBLE DIAGNOSES WORK FLOW

< SERVICE INFORMATION >

[CAN FUNDAMENTAL]

## Trouble Diagnosis Flow Chart

INFOID:000000003032425

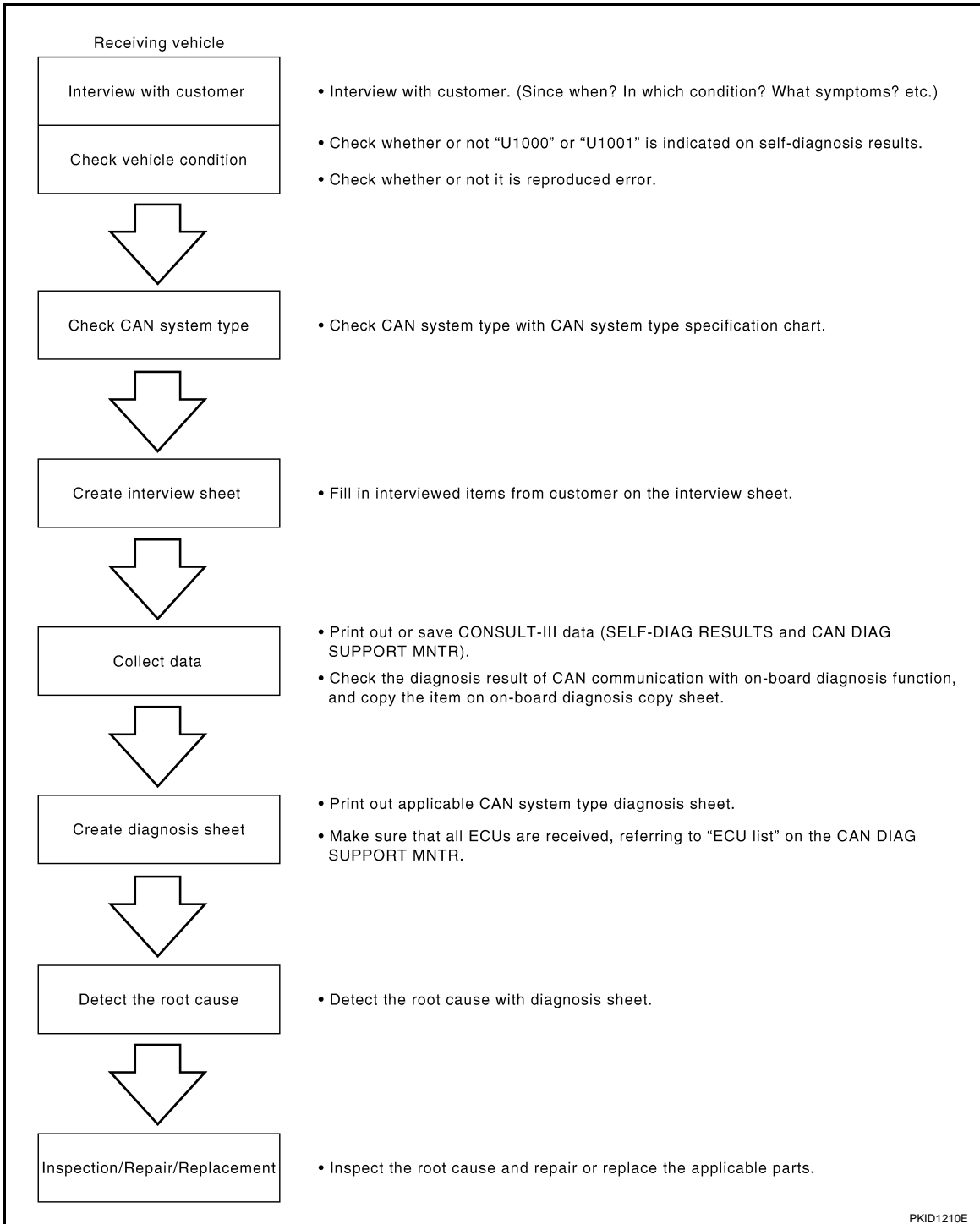

A

B

C

D

E

F

G

H

I

J

LAN

L

M

N

O

P

## Trouble Diagnosis Procedure

INFOID:000000003032426

### INTERVIEW WITH CUSTOMER

Interview with the customer is important to detect the root cause of CAN communication system errors and to understand vehicle condition and symptoms for proper trouble diagnosis.

Points in interview

- What: Parts name, system name
- When: Date, Frequency
- Where: Road condition, Place
- In what condition: Driving condition/environment

# TROUBLE DIAGNOSES WORK FLOW

< SERVICE INFORMATION >

[CAN FUNDAMENTAL]

- Result: Symptom

**NOTE:**

- Check normal units as well as error symptoms.
- Example: Circuit between ECM and the combination meter is judged normal if the customer indicates tachometer functions normally.
- When a CAN communication system error is present, multiple control units may malfunction or go into fail-safe mode.
- Indication of the combination meter is important to detect the root cause because it is the most obvious to the customer, and it performs CAN communication with many units.

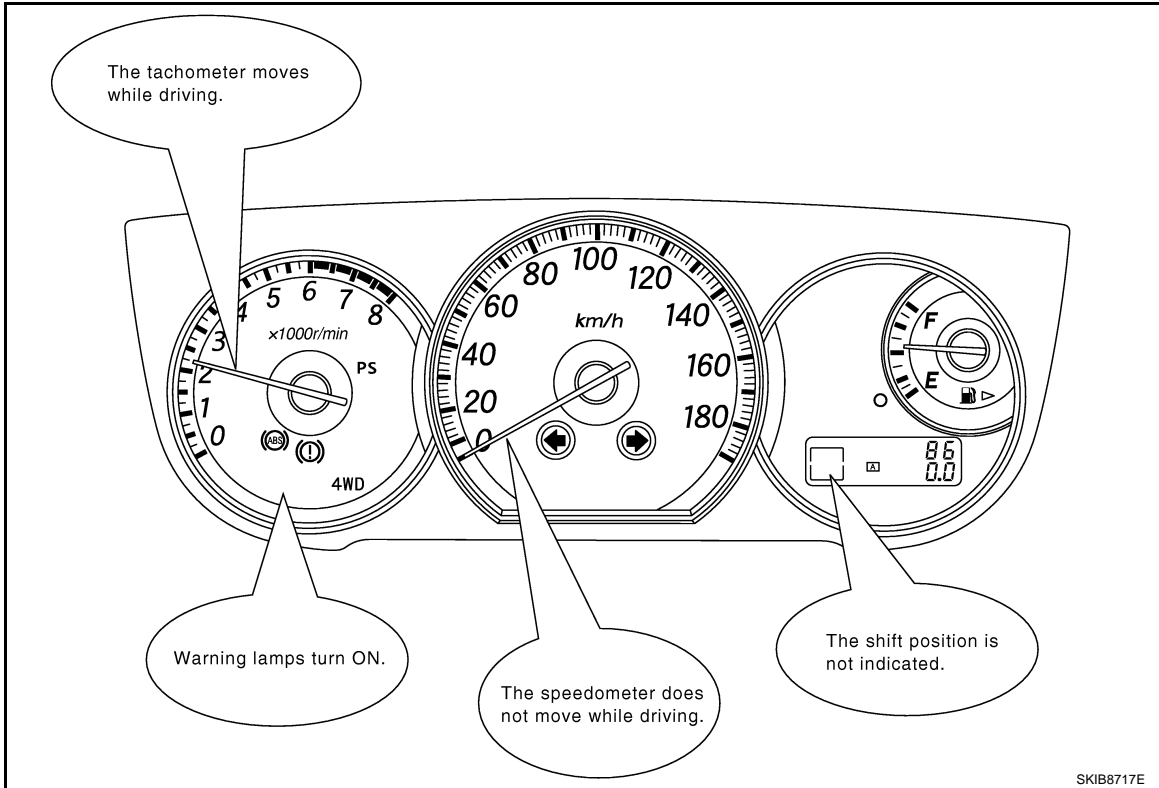

## INSPECTION OF VEHICLE CONDITION

- Check whether or not "U1000" or "U1001" is indicated on "SELF-DIAG RESULTS" by CONSULT-III.

**NOTE:**

Root cause cannot be detected using the procedure in this section if "U1000" or "U1001" is not indicated.

- Check whether the symptom is reproduced or not.

**NOTE:**

- Do not turn the ignition switch OFF or disconnect the battery cable while reproducing the error. The error may temporarily correct itself, making it difficult to determine the root cause.
- The procedures for present errors differ from the procedures for past errors. Refer to "DETECT THE ROOT CAUSE".

## CHECK OF CAN SYSTEM TYPE (HOW TO USE CAN SYSTEM TYPE SPECIFICATION CHART)

Determine CAN system type based on vehicle equipment. Then choose the correct diagnosis sheet.

**NOTE:**

There are two styles for CAN system type specification charts. Depending on the number of available system types, either style A or style B may be used.

CAN System Type Specification Chart (Style A)

**NOTE:**

# TROUBLE DIAGNOSES WORK FLOW

< SERVICE INFORMATION >

[CAN FUNDAMENTAL]

CAN system type is easily checked with the vehicle equipment identification information shown in the chart.

Example:  
Vehicle is equipped as follows: Wagon, AWD, VQ35DE, CVT, VDC, and Intelligent Key system. (○ shows an example of CAN system type.)

**CAN System Specification Chart**  
Determine CAN system type from the following specification chart. Then choose the correct diagnosis sheet.

Body type	Wagon					
Axle	2WD			AWD		
Engine	QR25DE		VQ35DE			
Transmission	A/T			CVT		
Brake control	ABS				VDC	
Intelligent Key system		X		X		X
CAN system type	1	2	3	4	5	6
Diagnosis sheet	(XX-XX)	(XX-XX)	(XX-XX)	(XX-XX)	(XX-XX)	(XX-XX)
CAN communication signal chart	XX-XX. "TYPE 1/TYPE 2"		XX-XX. "TYPE 3/TYPE 4"		XX-XX. "TYPE 5/TYPE 6"	

X : Applicable

**VEHICLE EQUIPMENT IDENTIFICATION INFORMATION**  
**NOTE:**  
Check CAN system type from the vehicle shape and equipment.

With VDC

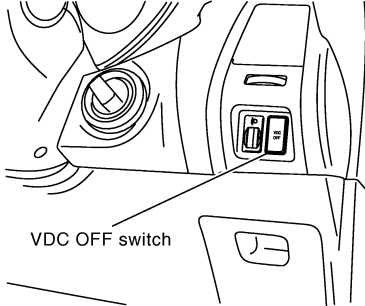

VDC OFF switch

With Intelligent Key system

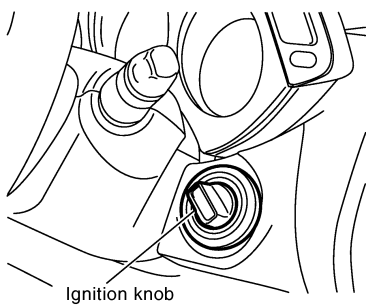

Ignition knob

In the above example,  
• Checking VDC OFF switch leads to judge whether or not VDC is equipped.  
• Checking the ignition knob leads to judge whether or not Intelligent Key system is equipped.

[ For the above case, CAN system type is "6". ]

SKIB888E

A  
B  
C  
D  
E  
F  
G  
H  
I  
J  
L  
M  
N  
O  
P

LAN

CAN System Type Specification Chart (Style B)

**NOTE:**

# TROUBLE DIAGNOSES WORK FLOW

< SERVICE INFORMATION >

[CAN FUNDAMENTAL]

CAN system type is easily checked with the vehicle equipment identification information shown in the chart.

Example:

Vehicle is equipped as follows: Sedan, 2WD, MR20DE, CVT, ABS, Active AFS, Intelligent Key system, Navigation system and Automatic drive positioner. (○ shows an example of CAN system type.)

### CAN System Specification Chart

Refer to the specification as shown in the chart.

Body type	Sedan		
Axle	2WD		AWD
Engine	HR15DE	MR20DE	HR15DE
Transmission	A/T	CVT	A/T
Brake control	ABS		
Specification chart	○○○○ SPECIFICATION CHART A	○○○○ SPECIFICATION CHART B	○○○○ SPECIFICATION CHART C

Check the vehicle equipment with the vehicle identification number plate.

Check the vehicle equipment.

Select the applicable vehicle equipment. Refer to the specification chart.

x: Applicable

### SPECIFICATION CHART B

Determine CAN system type from the following specification chart. Then choose the correct diagnosis sheet.

Body type	Sedan											
Axle	2WD											
Engine	MR20DE											
Transmission	CVT											
Brake control	ABS											
Active AFS		x			x	x			x	x		x
Intelligent Key system			x		x		x	x	x	x		x
Navigation system				x			x	x		x		x
Automatic drive positioner								x			x	x
CAN system type	9	10	11	12	13	14	15	16	17	18	19	20
Diagnosis sheet	○○	○○	○○	○○	○○	○○	○○	○○	○○	○○	○○	○○
CAN communication signal chart	○○○○ TYPE SWYER ○○○○ TYPE 13TYPE 13TYPE 13TYPE 13TYPE 13TYPE 13TYPE 13TYPE 13TYPE 13TYPE 13TYPE 13											

Check the vehicle equipment.

The number indicates the CAN system type of the vehicle.

x: Applicable

### VEHICLE EQUIPMENT IDENTIFICATION INFORMATION

#### NOTE:

Check CAN system type from the vehicle shape and equipment.

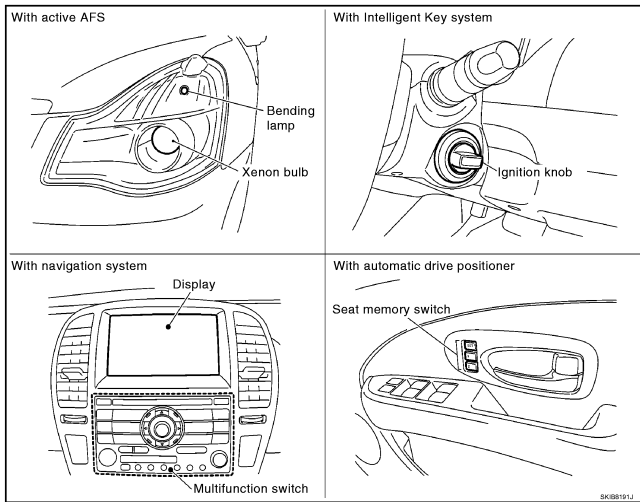

In the above example,

- Checking Xenon bulb and bending lamp lead to judge whether or not Active AFS is equipped.
- Checking the ignition knob leads to judge whether or not Intelligent Key system is equipped.
- Checking display and multifunction switch lead to judge whether or not Navigation system is equipped.
- Checking seat memory switch leads to judge whether or not Automatic drive positioner is equipped.

For the above case, CAN system type is "20".

SKIB889E

## CREATE INTERVIEW SHEET

Fill out the symptom described by the customer, vehicle condition, and CAN system type on the interview sheet.



# TROUBLE DIAGNOSES WORK FLOW

< SERVICE INFORMATION >

[CAN FUNDAMENTAL]

Interview Sheet (Example)

CAN Communication System Diagnosis Interview Sheet	
Date received:	3, Feb. 2005
Type: DBA-KG11	VIN No.: KG11-005040
Model: BDRARGZ397EDA-E-J-	
First registration: 10, Jan. 2005	Mileage: 621
CAN system type: Type 19	
Symptom (Results from interview with customer)	
<ul style="list-style-type: none"><li>• Headlamps suddenly turn ON while driving the vehicle.</li><li>• The engine does not restart after stopping the vehicle and turning the ignition switch OFF.</li><li>• The cooling fan continues rotating while turning the ignition switch ON.</li></ul>	
Condition at inspection	
Error Symptom: <u>Present</u> / Past	
<p>The engine does not start. While turning the ignition switch ON,</p> <ul style="list-style-type: none"><li>• The headlamps (Lo) turn ON, and the cooling fan continues rotating.</li><li>• The interior lamp does not turn ON.</li></ul> <p>On CONSULT-III screen,</p> <ul style="list-style-type: none"><li>• IPDM E/R is not indicated on SELECT SYSTEM.</li><li>• ENGINE: U1001</li><li>• BCM, ADAPTIVE LIGHT: U1000</li></ul>	

PKID1211E

## COLLECT DATA

Collect CONSULT-III Data

Print out or save the following CONSULT-III data.

- SELF-DIAG RESULTS
- CAN DIAG SUPPORT MNTR ("ECU list" included)

**NOTE:**

A  
B  
C  
D  
E  
F  
G  
H  
I  
J  
LAN  
L  
M  
N  
O  
P

# TROUBLE DIAGNOSES WORK FLOW

< SERVICE INFORMATION >

[CAN FUNDAMENTAL]

Some items may not be needed depending on CAN system type of vehicle.

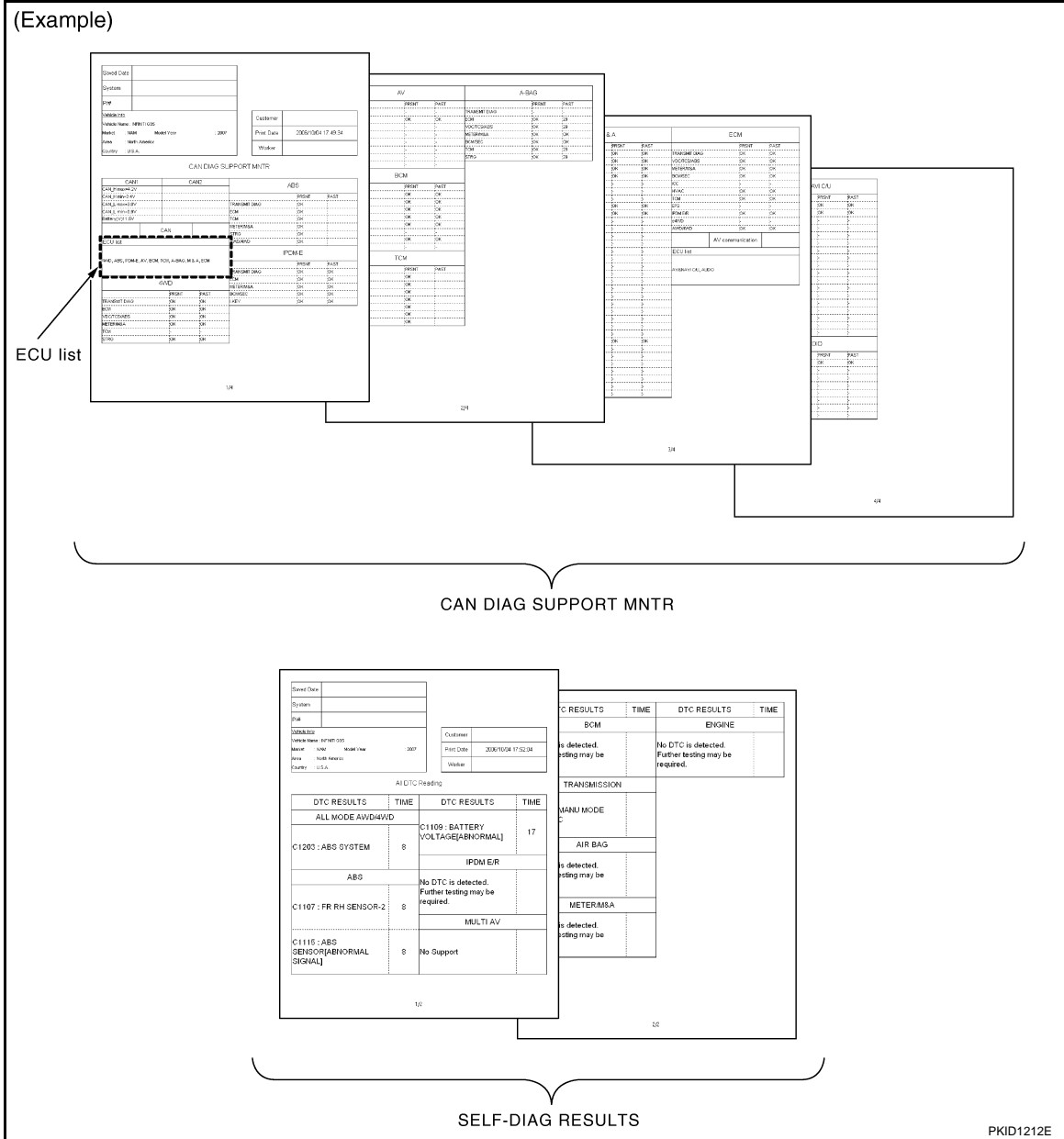

Create On-board Diagnosis Copy Sheet

Display the trouble diagnosis result of CAN communication with the on-board diagnosis function on the vehicle monitor, etc. Copy them on the on-board diagnosis copy sheet.

**NOTE:**

- For some models, CAN communication diagnosis result is received from the vehicle monitor. (CONSULT-III is not available.)

# TROUBLE DIAGNOSES WORK FLOW

< SERVICE INFORMATION >

[CAN FUNDAMENTAL]

- For the details, refer to [LAN-51. "Data Sheet"](#).

Example: Copy the diagnosis result of CAN communication from the vehicle monitor.

Vehicle monitor indication

CAN DIAG SUPPORT MONITOR				Delete
CAN_COMM	OK	0		
CAN_CIRC_1	OK	0		
CAN_CIRC_2	UNKWN	12		
CAN_CIRC_3	UNKWN	12		
CAN_CIRC_4	UNKWN	0		
CAN_CIRC_5	OK	0		
CAN_CIRC_6	UNKWN	0		
CAN_CIRC_7	OK	0		
CAN_CIRC_8	UNKWN	0		
CAN_CIRC_9	UNKWN	50		

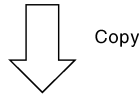

Vehicle monitor (Display control unit) CAN DIAG SUPPORT MONITOR copy sheet

Indication item (Diagnosis item)	Vehicle monitor		Indication item (Diagnosis item)	Vehicle monitor	
	Result indicated	Error counter		Result indicated	Error counter
CAN_COMM (Initial diagnosis)	OK	0	CAN_CIRC_5 (Receive diagnosis of Unified meter and A/C amp.)	OK	0
CAN_CIRC_1 (Transmit diagnosis)	OK	0	CAN_CIRC_6	Not available	
CAN_CIRC_2 (Receive diagnosis of BCM)	UNKWN	12	CAN_CIRC_7 (Receive diagnosis of IPDM E/R)	OK	0
CAN_CIRC_3 (Receive diagnosis of ECM)	UNKWN	12	CAN_CIRC_8	Not available	
CAN_CIRC_4	Not available		CAN_CIRC_9	Not available	

Result indicated: Fill in the indication (OK, NG or UNKWN).  
Error counter: Fill in the indicated number.

SK1B8722E

## CREATE DIAGNOSIS SHEET

### NOTE:

Be sure to use the diagnosis sheet for the correct CAN system type.

Print Diagnosis Sheet

Print the diagnosis sheet for the applicable CAN system type.

Check Collected Data

Make sure that all ECUs are received, referring to "ECU list".

A  
B  
C  
D  
E  
F  
G  
H  
I  
J  
L  
M  
N  
O  
P

# TROUBLE DIAGNOSES WORK FLOW

< SERVICE INFORMATION >

[CAN FUNDAMENTAL]

- For abbreviations, refer to [LAN-36, "Abbreviation List"](#).

Unit names are indicated by abbreviations.

CAN-H and CAN-L are described with one line.

Used for detecting root cause.

▲ indicates Diag on CAN unit.

▲ indicates Diag on CAN unit.

Fill out possible root cause and inspection result.

Make sure that all ECUs are received, referring to "ECU list".

ECU list →

CAN1		CAN2		IPDM-E	
CAN_H max=4.4V					
CAN_H min=2.3V				PRSENT	PAST
CAN_L max=3.1V				TRANSMIT DIAG	OK
CAN_L min=1.0V				ECM	OK
Battery(V)11.7V				BCM/SEC	OK
CAN				AV	
ECU list				PRSENT	PAST
ABS, IPDM-E, AV, BCM, TCM, M&A, ECM, EPS, AFS, I-KEY, ADP				TRANSMIT DIAG	-
				ECM	OK
				METER/M&A	OK
				BCM/SEC	-
				HVAC	-
				IPDM E/R	-
				TIRE-P	-
ABS					
		PRSENT	PAST		
INITIAL DIAG		OK			
TRANSMIT DIAG		OK			
ECM		OK			

PKID1213E

## DETECT THE ROOT CAUSE

Identify the root cause using the created diagnosis sheet.

Identifying the root cause

- Draw a line on the diagnosis sheet to indicate the possible cause. Narrow the search.

### NOTE:

- Color-code when drawing lines.
- Do not draw a line onto an existing line.
- Drawing a line is not necessary if the circuit is shorted. Refer to "Present Error — Short Circuit —", "Past Error — Short Circuit —".

Refer to the following for details of the trouble diagnosis procedure.

- "Present Error — Open Circuit —"
- "Present Error — Short Circuit —"
- "Past Error — Open Circuit —"
- "Past Error — Short Circuit —"

### NOTE:

When the root cause appears to be a branch line or short circuit, be sure to check the control unit as well as the communication line.

Present Error — Open Circuit —

# TROUBLE DIAGNOSES WORK FLOW

< SERVICE INFORMATION >

[CAN FUNDAMENTAL]

Identify the error circuit using information from the “CAN DIAG SUPPORT MNTR” (“ECU list” included).

1. ECU list: Check the items indicated in “ECU list”. Draw a line on the diagnosis sheet to indicate the error circuit.

**NOTE:**

CAN communication line has no error if units other than Diag on CAN units are not indicated. An error may be on the power supply of the control unit, DDL1 line or DDL2 line.

- a. “TCM” which is Diag on CAN unit, is not indicated on “ECU list”. This indicates that DLC is not receiving a signal from TCM. Draw a line to indicate an error between DLC and TCM (line 1-a in the figure below).

**NOTE:**

- Diag on CAN units are not indicated on the “ECU list” when the CAN line between Diag on CAN unit and the data link connector is open.
- For a description of Diag on CAN, refer to [LAN-4, "Diag on CAN"](#).

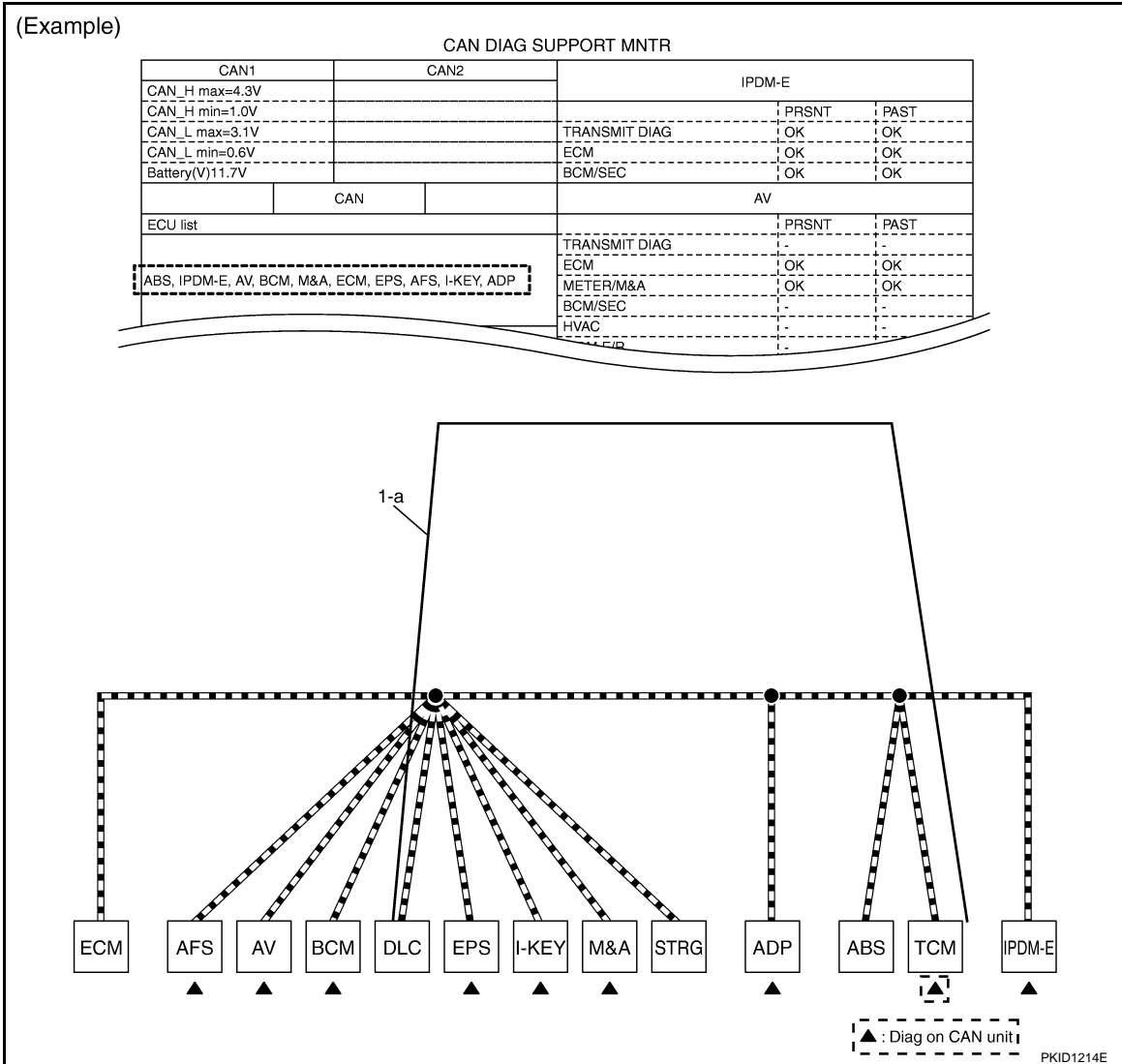

2. CAN DIAG SUPPORT MNTR: Check each item on “CAN DIAG SUPPORT MNTR”. Draw a line on the diagnosis sheet to indicate the error circuit.

- a. Reception item of “ECM”: On “TCM”, “UNKWN” is indicated. This means ECM cannot receive the signal from TCM. Draw a line to indicate an error between ECM and TCM (line 2-a in the figure below).

**NOTE:**

If “UNKWN” is indicated on “TRANSMIT DIAG”, then the control unit cannot transmit CAN communication signal to each unit. Draw a line between the control unit and the splice.

- b. Reception item of “AFS”: On “TCM”, “UNKWN” is indicated. This means AFS cannot receive the signal from TCM. Draw a line to indicate an error between AFS and TCM (line 2-b in the figure below).

# TROUBLE DIAGNOSES WORK FLOW

< SERVICE INFORMATION >

[CAN FUNDAMENTAL]

- c. Reception item of "AV": "UNKWN" is not indicated. This indicates normal communication between AV and its receiving units. Do not draw any line.

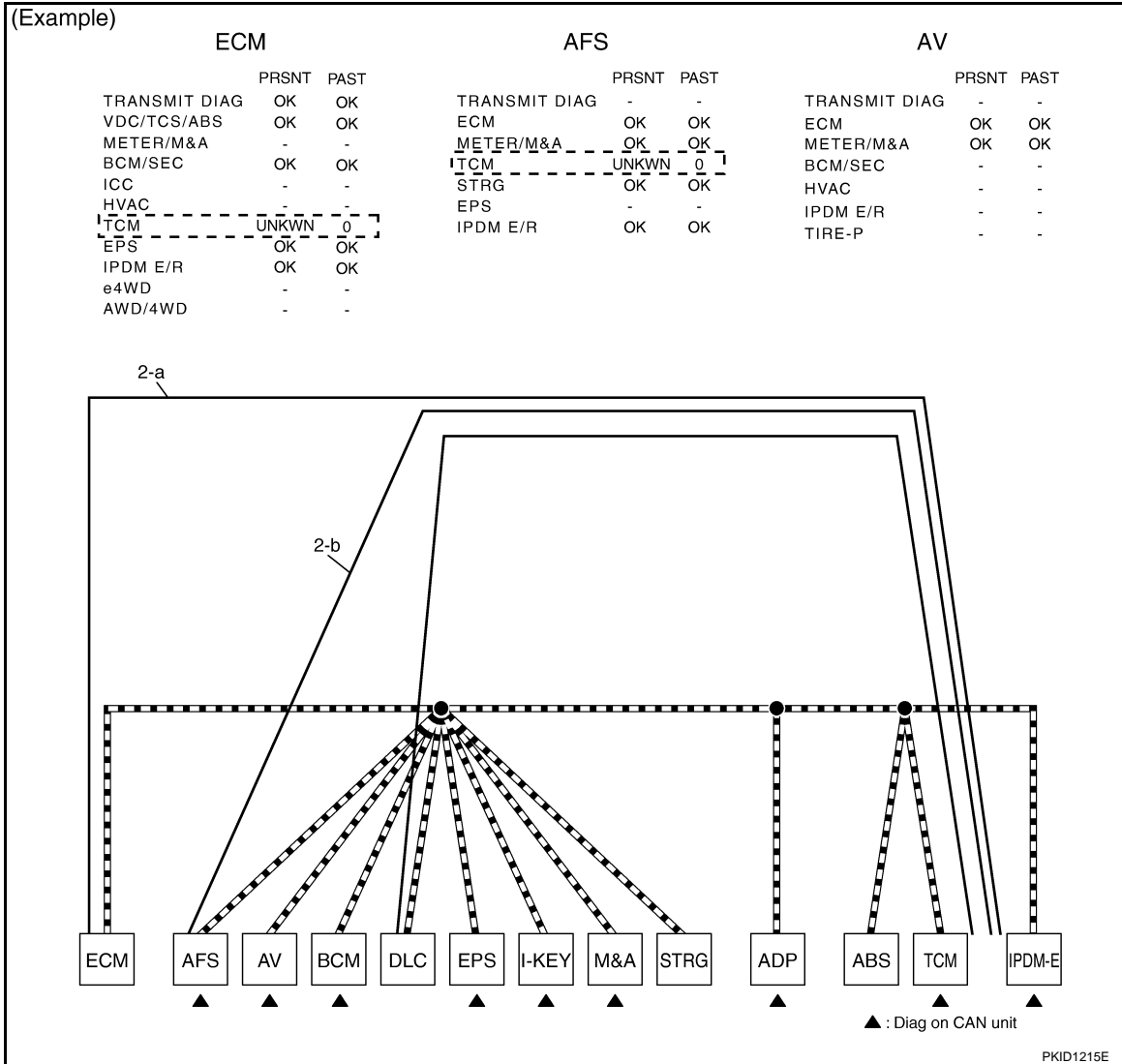

- d. Reception item of "BCM": On "TCM", "UNKWN" is indicated. This means BCM cannot receive the signal from TCM. Draw a line to indicate an error between BCM and TCM (line 2-d in the figure below).
- e. Reception item of "EPS" and "I-KEY": "UNKWN" is not indicated. This indicates normal communication between EPS and I-KEY and their receiving units. Do not draw any line.

**NOTE:**

# TROUBLE DIAGNOSES WORK FLOW

< SERVICE INFORMATION >

[CAN FUNDAMENTAL]

On CAN DIAG SUPPORT MNTR (without PAST), "UNKWN" is indicated even though the item is not used in the trouble diagnosis. For the details of each item on CAN diagnostic support monitor, refer to [LAN-38, "CAN Diagnostic Support Monitor"](#).

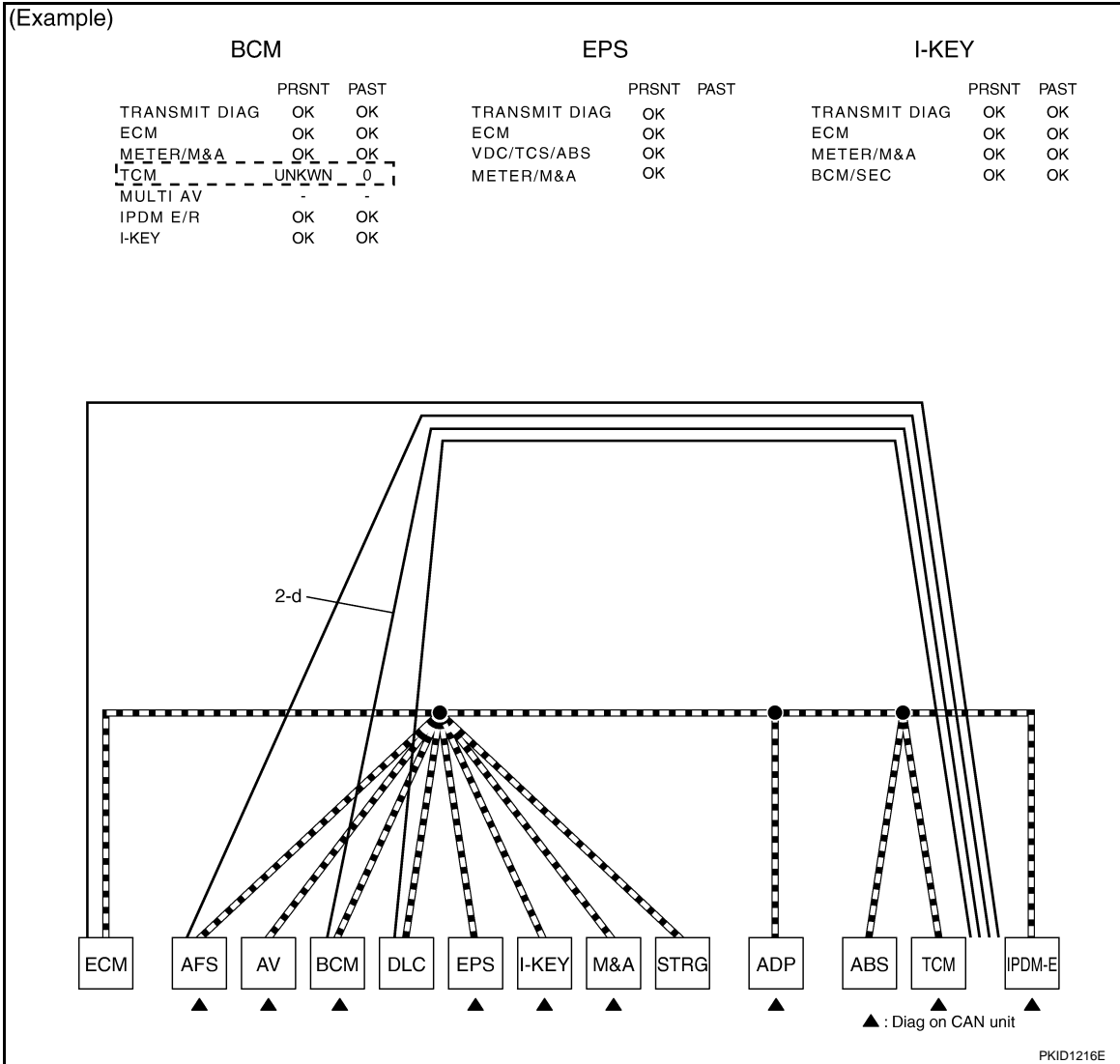

- f. Reception item of "M&A": On "TCM", "UNKWN" is indicated. This means M&A cannot receive the signal from TCM. Draw a line to indicate an error between M&A and TCM (line 2-f in the figure below).
- g. Reception item of "ADP": On "TCM", "UNKWN" is indicated. This means ADP cannot receive the signal from TCM. Draw a line to indicate an error between ADP and TCM (line 2-g in the figure below).

# TROUBLE DIAGNOSES WORK FLOW

< SERVICE INFORMATION >

[CAN FUNDAMENTAL]

h. Reception item of "ABS": "UNKWN" is not indicated. This indicates normal communication between ABS and its receiving units. Do not draw any line.

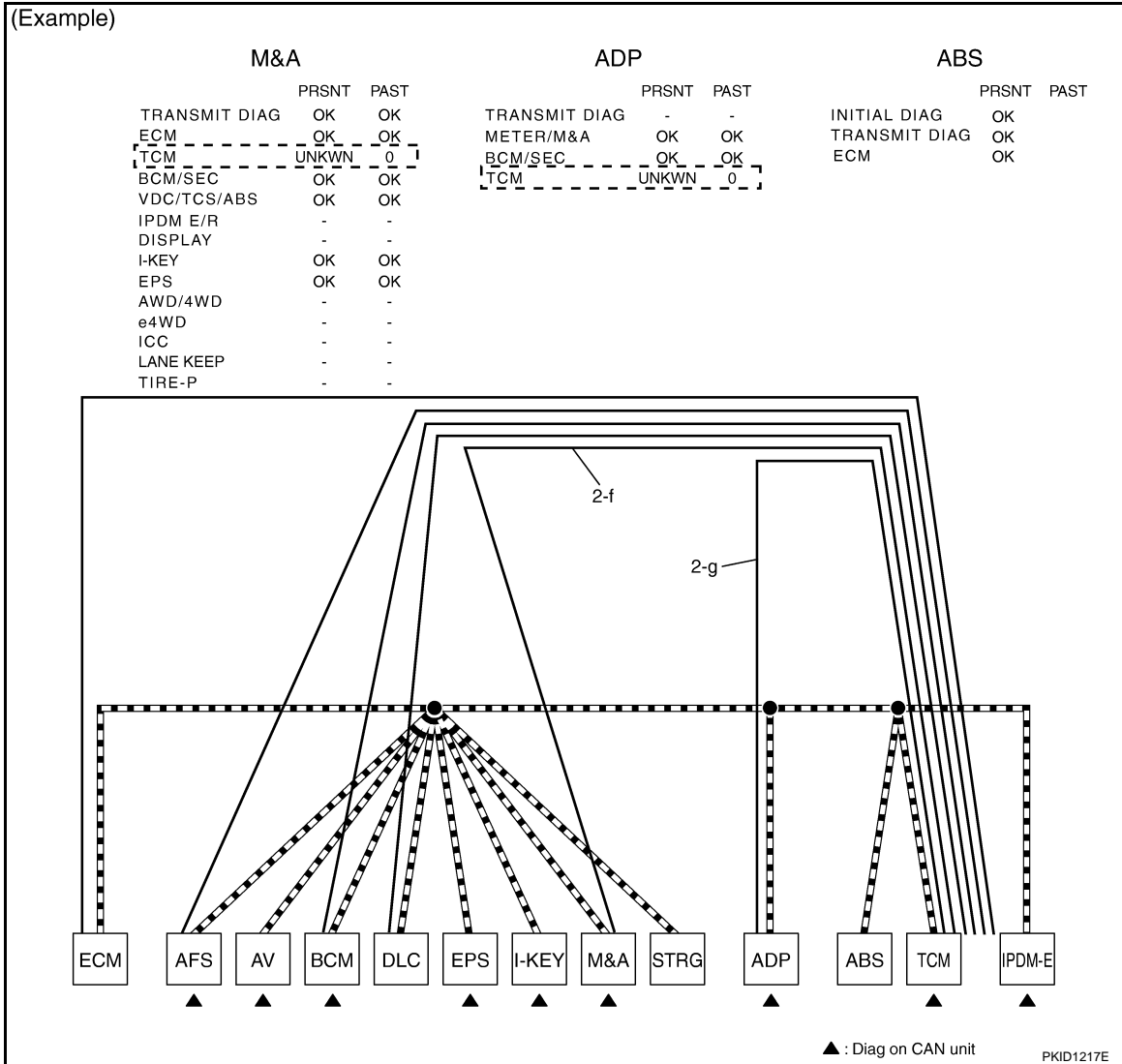

- i. Reception item of "IPDM-E": "UNKWN" is not indicated. This indicates normal communication between IPDM-E and its receiving units. Do not draw any line.
- 3. Based on information received from "CAN DIAG SUPPORT MNTR", place a check mark on the known good CAN communication line between ECM and IPDM-E.
  - a. Through the previous procedure, the circuit between ADP splice and TCM has the most amount of lines (shade 3-a in the figure below).
  - b. Place a check mark on the known good lines to establish the error circuit.



# TROUBLE DIAGNOSES WORK FLOW

< SERVICE INFORMATION >

[CAN FUNDAMENTAL]

Reception item of "IPDM-E": On "ECM", "OK" is indicated. IPDM-E communicates normally with ECM. Put a check mark on the normal circuit between ECM and IPDM-E (check mark 3-b in the figure below).

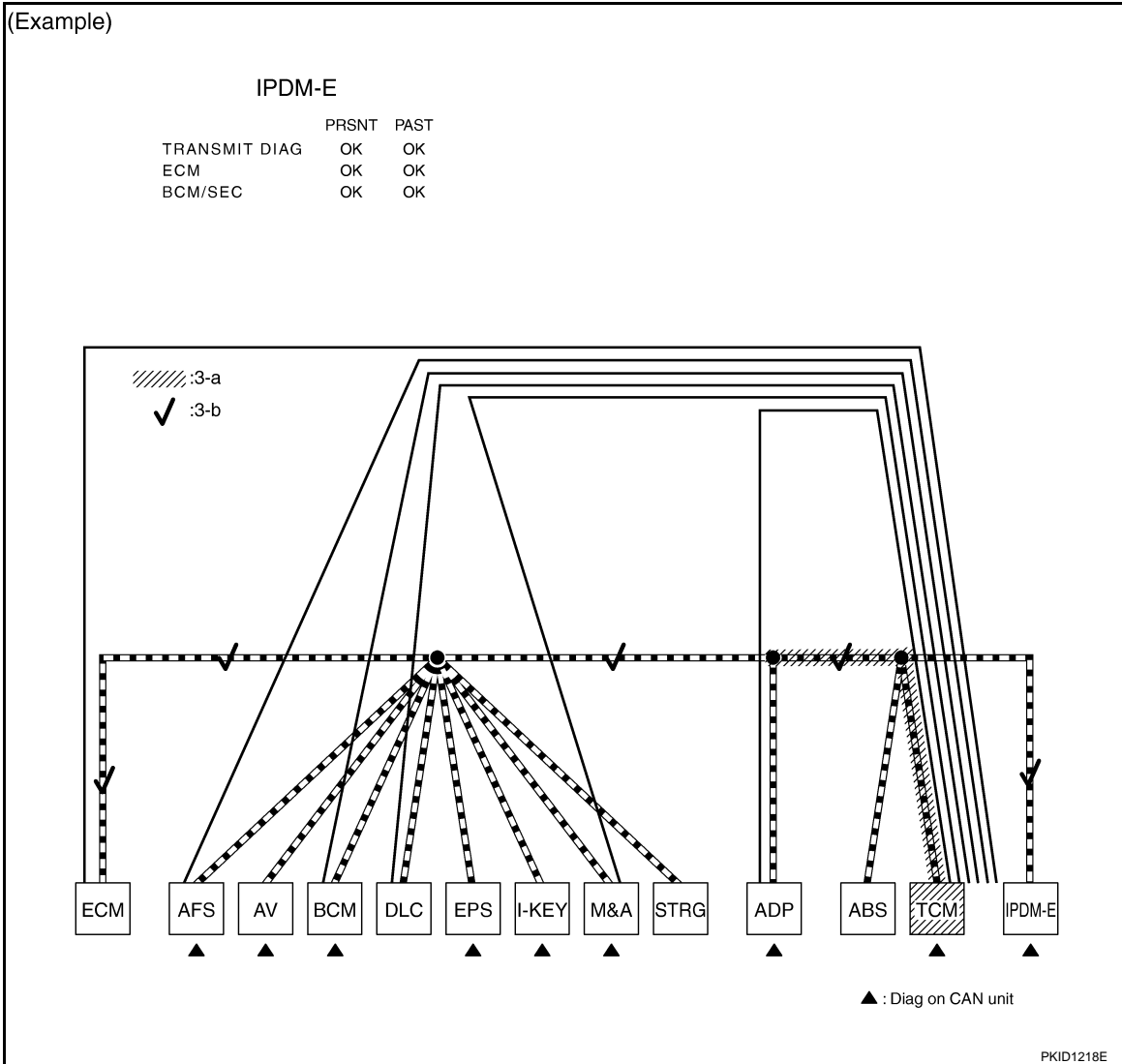

4. Through the above procedure, the error is detected in the TCM branch line (shaded in the figure below).

**NOTE:**

For abbreviations, refer to [LAN-36. "Abbreviation List"](#).

A  
B  
C  
D  
E  
F  
G  
H  
I  
J  
L  
M  
N  
O  
P

LAN

# TROUBLE DIAGNOSES WORK FLOW

< SERVICE INFORMATION >

[CAN FUNDAMENTAL]

5. Perform the inspection for the detected error circuit. For the inspection procedure, refer to [LAN-56. "Malfunction Area Chart"](#).

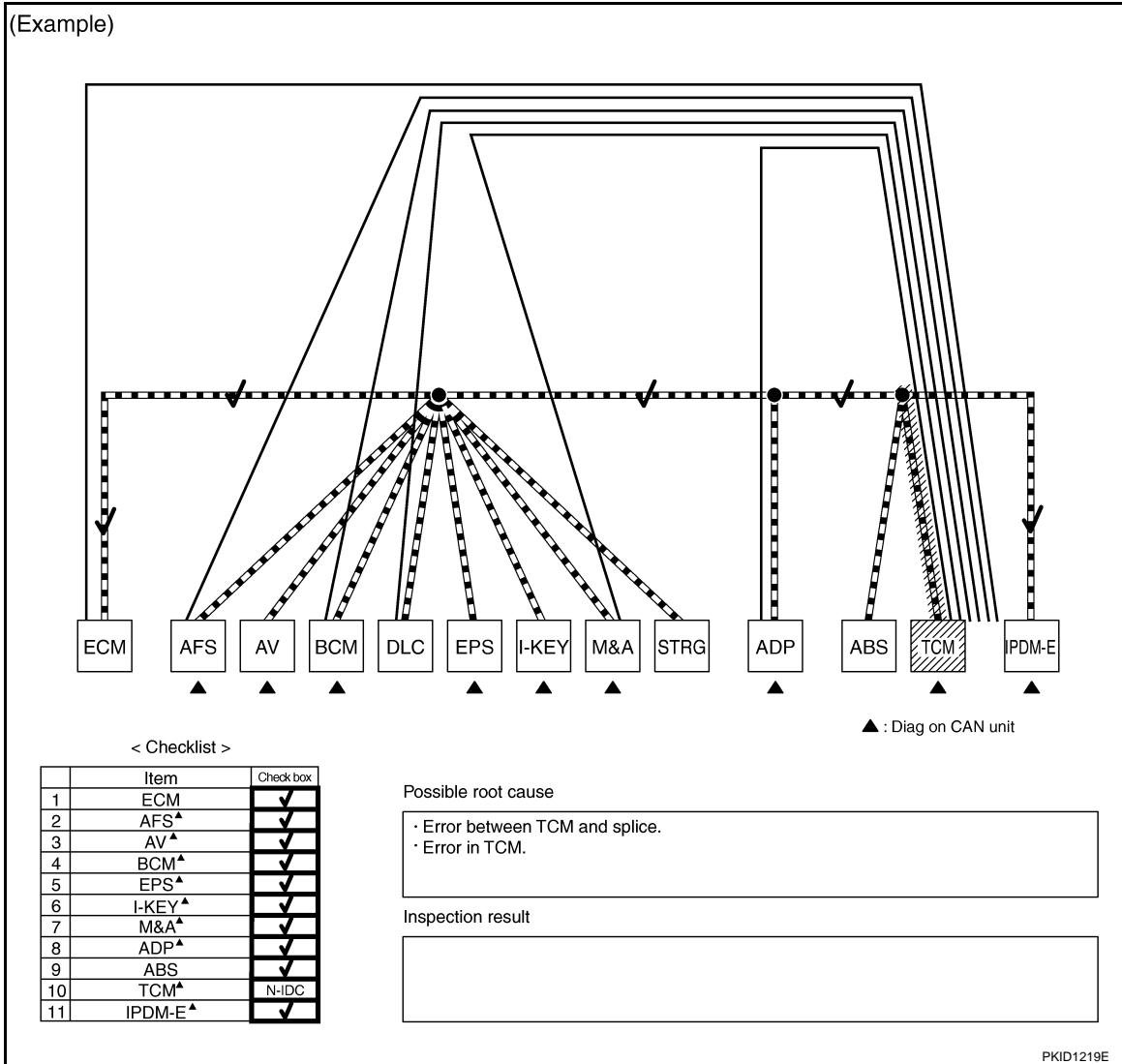

**Present Error — Short Circuit —**

When the symptoms listed below exist, a short circuit of the CAN communication line is a possible cause.

Received data

Item (CONSULT-III)	Indication
ECU list (on the CAN DIAG SUPPORT MNTR)	All Diag on CAN units are not indicated.
CAN DIAG SUPPORT MNTR	"UNKWN" is indicated under "TRANSMIT DIAG" and most reception items.

**Error symptom**

- Most the units connected to the CAN communication system go into fail-safe mode or are deactivated.

**Inspection procedure**

# TROUBLE DIAGNOSES WORK FLOW

< SERVICE INFORMATION >

[CAN FUNDAMENTAL]

- Refer to [LAN-56. "Malfunction Area Chart"](#).

(Example)

### CAN DIAG SUPPORT MNTR

CAN1		CAN2		ECM		
CAN_H max=4.3V					PRSNT	PAST
CAN_H min=1.0V					UNKWN	0
CAN_L max=3.1V				TRANSMIT DIAG	UNKWN	0
CAN_L min=0.6V				VDC/TCS/ABS	UNKWN	0
Battery(V)11.7V				METER/M&A	-	-
		CAN		BCM/SEC	UNKWN	0
ECU list				ICC	-	-
All Diag on CAN units are not indicated. { ABS, ECM				HVAC	-	-
				TCM	UNKWN	0
				EPS	UNKWN	0
				IPDM E/R	UNKWN	0
				e4WD	-	-
				AWD/4WD	-	-
		ABS				
					PRSNT	PAST
				INITIAL DIAG	NG	
				TRANSMIT DIAG	UNKWN	
				ECM	UNKWN	

"UNKWN" is indicated under most reception items of CAN DIAG SUPPORT MNTR.

PKID1220E

A  
B  
C  
D  
E  
F  
G  
H  
I  
J  
L  
M  
N  
O  
P

LAN

Past Error — Open Circuit —

Review CAN communication signal chart based on information received from the interview with the customer and on past error information from SELF-DIAG RESULTS and CAN DIAG SUPPORT MNTR.

# TROUBLE DIAGNOSES WORK FLOW

< SERVICE INFORMATION >

[CAN FUNDAMENTAL]

1. SELF-DIAG RESULTS: Inspect the control units indicating “U1000” or “U1001” on SELF-DIAG RESULTS.

ALL DTC READING			
DTC RESULTS	TIME	DTC RESULTS	TIME
ABS		BCM	
U1000 : CAN COMM CIRCUIT	3	No DTC is detected. Further testing may be required.	
IPDM E/R		TRANSMISSION	
No DTC is detected. Further testing may be required.		U1000 : CAN COMM CIRCUIT	3
MULTI AV		METER	
No DTC is detected. Further testing may be required.		U1000 : CAN COMM CIRCUIT	3
DTC RESULTS	TIME	DTC RESULTS	TIME
EPS		AUTO DRIVE POS.	
U1000 : CAN COMM CIRCUIT	PAST	No DTC is detected. Further testing may be required.	
ENGINE			
U1001 : CAN COMM CIRCUIT	1t		
ADAPTIVE LIGHT			
No DTC is detected. Further testing may be required.			
INTELLIGENT KEY			
No DTC is detected. Further testing may be required.			

PKID1221E

2. CAN DIAG SUPPORT MNTR (with PAST): Check the CAN DIAG SUPPORT MNTR (with PAST) of units indicating “U1000” or “U1001” on SELF-DIAG RESULTS. Draw a line on the diagnosis sheet to indicate the possible error circuit.

**NOTE:**

For the details of each indication on CAN DIAG SUPPORT MNTR, refer to [LAN-38, "CAN Diagnostic Support Monitor"](#).

- a. Reception item of “ECM”: “VDC/TCS/ABS”, “3” is indicated in the “PAST”. This means ECM could not receive the signal from ABS in the past. Draw a line between ECM and ABS (line 2-a in the figure below).
- b. Reception item of “M&A”: “VDC/TCS/ABS”, “3” is indicated in the “PAST”. This means M&A could not receive the signal from ABS in the past. Draw a line between M&A and ABS (line 2-b in the figure below).

# TROUBLE DIAGNOSES WORK FLOW

< SERVICE INFORMATION >

[CAN FUNDAMENTAL]

- c. Reception item of "TCM": "VDC/TCS/ABS", "3" is indicated in the "PAST". This means TCM could not receive the signal from ABS in the past. Draw a line between TCM and ABS (line 2-c in the figure below).

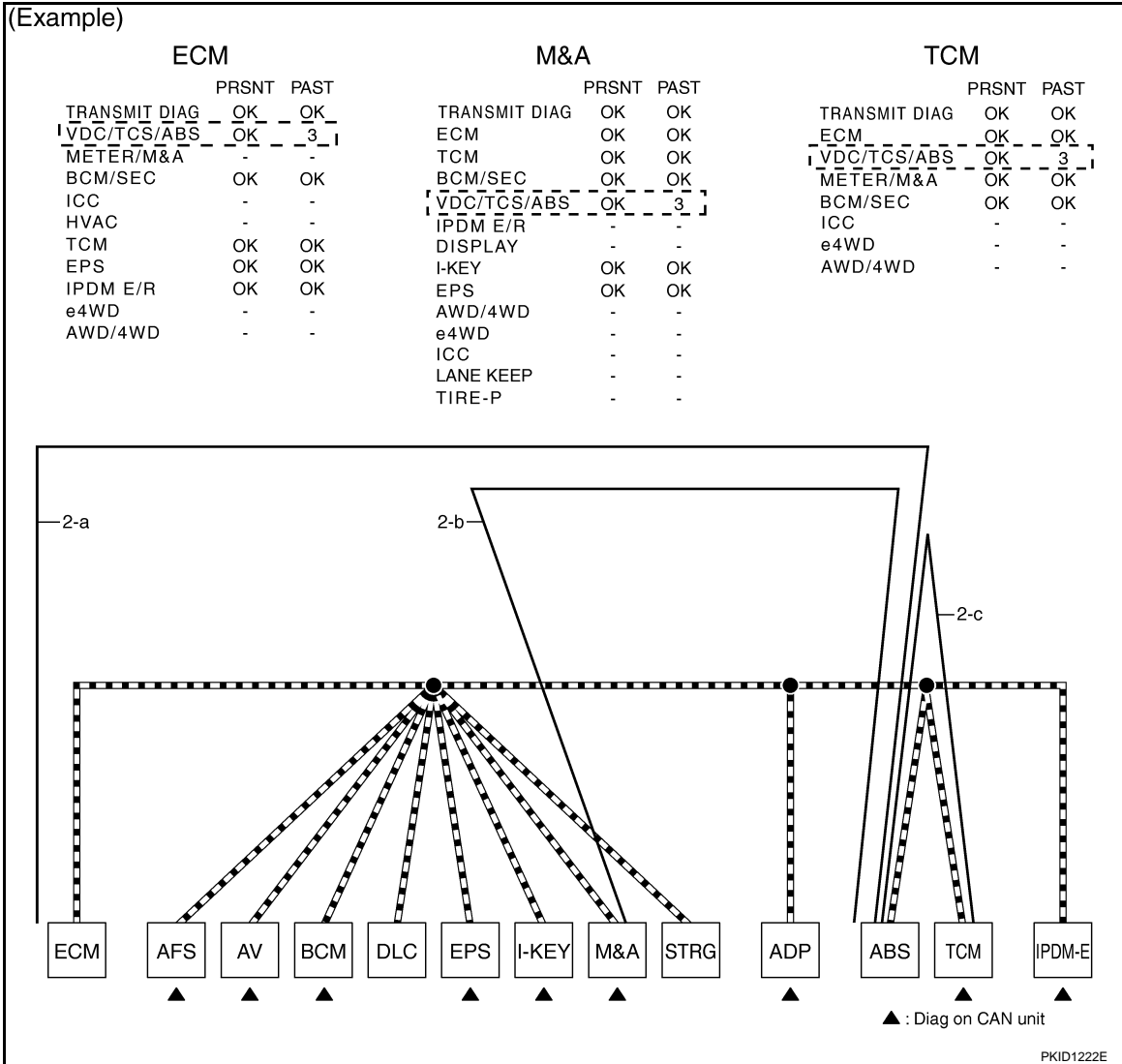

3. CAN DIAG SUPPORT MNTR (without PAST): Check the CAN DIAG SUPPORT MNTR (without PAST) of units indicating "U1000" or "U1001" on SELF-DIAG RESULTS. Draw a line on the diagnosis sheet to indicate the possible error circuit.

**NOTE:**

- While an error occurred in the past according to SELF-DIAG RESULTS, it is unclear which signal is not received. Assume that errors were detected from all reception items.
- Draw a single line among the unit and all reception items. (Work flow differs from CAN DIAG SUPPORT MNTR (with PAST).)

- a. Reception item of "EPS": Assume that the unit could not receive the signals from ECM, ABS, and M&A. Draw a line among EPS, ECM, ABS, and M&A (line 3-a in the figure below).

# TROUBLE DIAGNOSES WORK FLOW

< SERVICE INFORMATION >

[CAN FUNDAMENTAL]

- b. Reception item of "ABS": Assume that the unit could not receive the signal from ECM. Draw a line between ABS and ECM (line 3-b in the figure below).

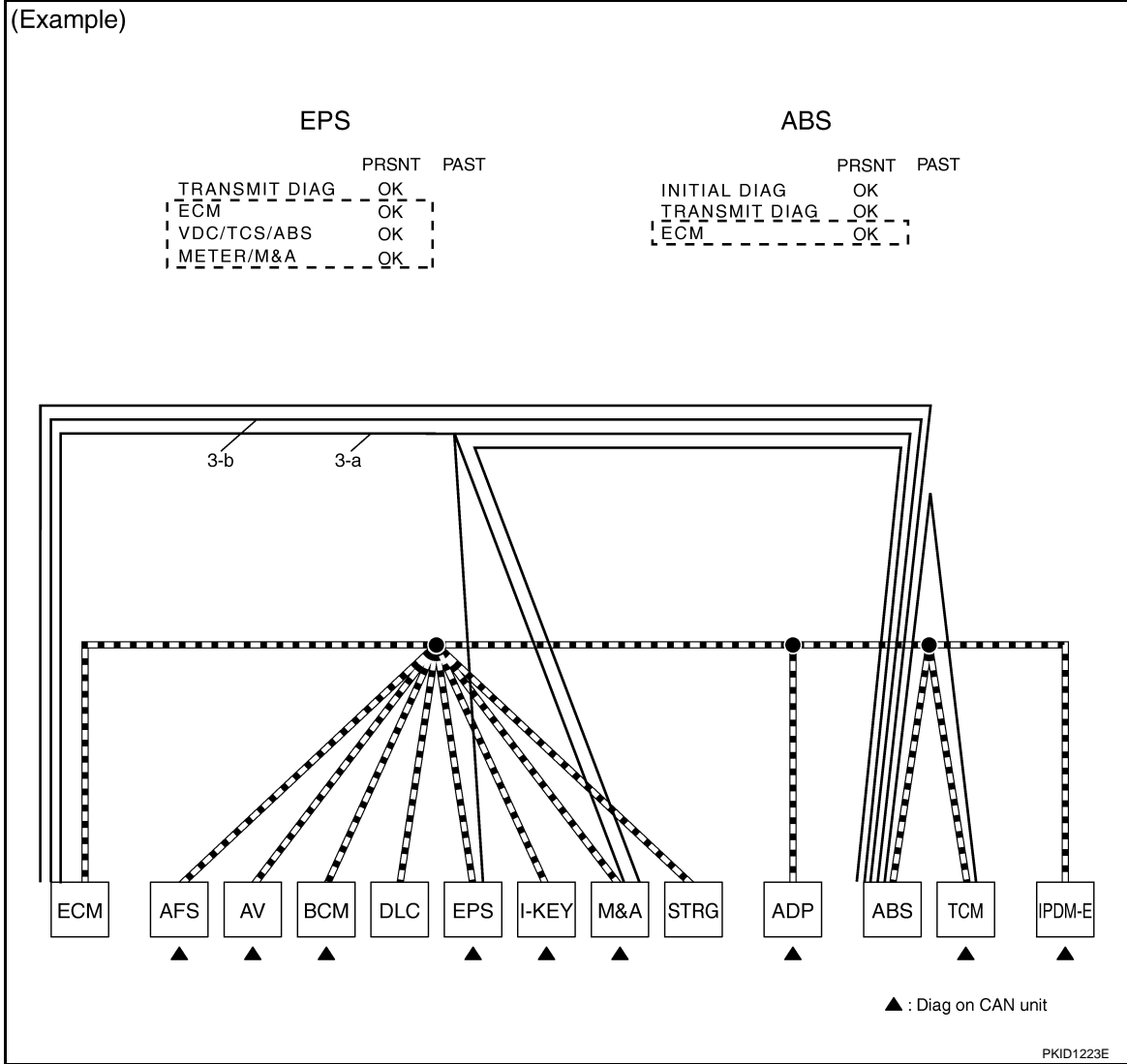

4. Search for the possible cause using CAN communication signal chart using information from the interview with the customer.

**NOTE:**

For the details of CAN communication signal, refer to [LAN-42. "CAN Communication Signal Chart"](#).

- a. ABS warning lamp turned ON and speedometer did not move: This means that "ABS warning lamp signal" and "Vehicle speed signal" could not communicate between M&A and ABS (4-a in the figure below).

# TROUBLE DIAGNOSES WORK FLOW

< SERVICE INFORMATION >

[CAN FUNDAMENTAL]

- b. The tachometer moved normally: This means that “Engine speed signal” could communicate normally between ECM and M&A (4-b in the figure below).

(Example)

First registration:

CAN system type:

Symptom (Results from interview with customer)

While driving,

- ABS warning lamp turned ON.
- Speedometer did not move.
- Tachometer moved normally.

**CAN Communication Signal Chart**

T: Transmit R: Receive

Signal name/Connecting unit	ECM	AFS <sup>1</sup>	AV <sup>2</sup>	BCM	EPS	I-KEY <sup>3</sup>	M&A	STRG <sup>1</sup>	ADP <sup>4</sup>	ABS	TCM	IFDM/E
A/C compressor request signal	T											R
Accelerator pedal position signal	T										R	
Closed throttle position signal	T										R	
Cooling fan speed request signal	T											R
Engine and CVT integrated control signal	T R										R T	
Engine coolant temperature signal	T						R				R	
4-b Engine speed signal	T						R				R	
Engine status signal	T		R		R							
Fuel consumption monitor signal	T		R				R					
MI signal	T						R					
Wide open throttle position signal	T										R	
4-a ABS warning lamp signal							R			T		
Brake warning lamp signal							R			T		
Steering angle sensor signal		R						T				
Vehicle speed signal	R	R		R	R	R	T		R	T	R	
Input shaft revolution signal	R											T
Output shaft revolution signal	R											T
Shift position indicator signal	R	R	R	R <sup>5</sup>			R		R <sup>6</sup>		T	
Second position indicator signal							R				T	
Front wiper stop position signal				R								T
High beam status signal	R	R										T
Low beam status signal	R	R										T

SKIB8895E

5. Fill out the diagnosis sheet based on information from step 4.
- a. The ABS warning lamp turned ON and speedometer did not move: Assume that a possible cause is no communication between M&A and ABS. Draw a line between M&A and ABS. (Line 5-a in the figure below).

# TROUBLE DIAGNOSES WORK FLOW

< SERVICE INFORMATION >

[CAN FUNDAMENTAL]

- b. The tachometer moved normally: Put check marks between ECM and M&A. The circuit between ECM and M&A is functioning properly (check marks 5-b in the figure below).

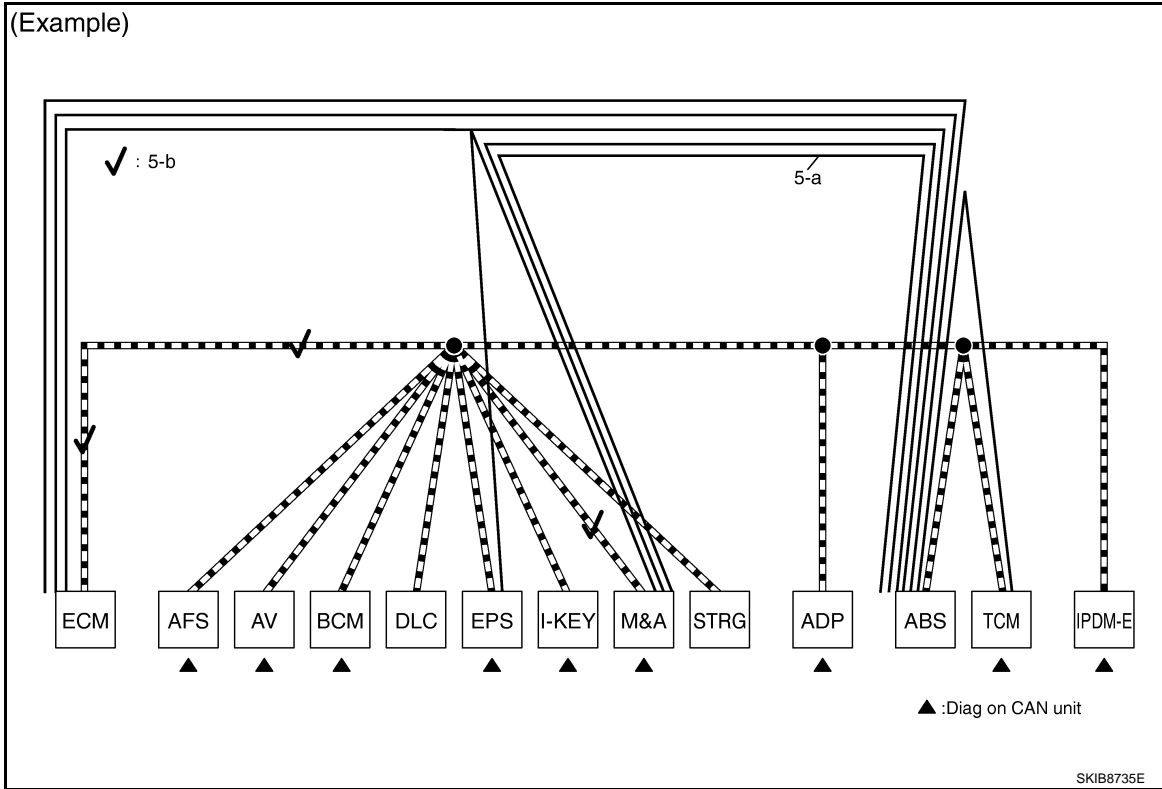

6. The circuit which has the most amount of lines are the possible cause. Error is detected from ABS actuator and electric unit (control unit) branch line (shaded in the figure below).

**NOTE:**

For abbreviations, refer to [LAN-36, "Abbreviation List"](#).



# TROUBLE DIAGNOSES WORK FLOW

< SERVICE INFORMATION >

[CAN FUNDAMENTAL]

7. Perform the inspection procedure for the possible cause. Refer to [LAN-56, "Malfunction Area Chart"](#).

(Example)

▲ : Diag on CAN unit

< Checklist >

	Item	Check box
1	ECM	<input checked="" type="checkbox"/>
2	AFS <sup>▲</sup>	<input checked="" type="checkbox"/>
3	AV <sup>▲</sup>	<input checked="" type="checkbox"/>
4	BCM <sup>▲</sup>	<input checked="" type="checkbox"/>
5	EPS <sup>▲</sup>	<input checked="" type="checkbox"/>
6	I-KEY <sup>▲</sup>	<input checked="" type="checkbox"/>
7	M&A <sup>▲</sup>	<input checked="" type="checkbox"/>
8	ADP <sup>▲</sup>	<input checked="" type="checkbox"/>
9	ABS	<input type="checkbox"/>
10	TCM <sup>▲</sup>	<input checked="" type="checkbox"/>
11	IPDM-E <sup>▲</sup>	<input checked="" type="checkbox"/>

Possible root cause

- Error between ABS actuator and electric unit (control unit) and splice.
- Error in ABS actuator and electric unit (control unit).

Inspection result

PKID1224E

**Past Error — Short Circuit —**

When the symptoms listed below exist, a short circuit of the CAN communication line is a possible cause.

Item (CONSULT-III)	Indication	Inspection procedure
SELF-DIAG RESULTS	"U1000" and "U1001" is indicated in the past for most units.	Refer to <a href="#">LAN-56, "Malfunction Area Chart"</a> .
CAN DIAG SUPPORT MNTR	Only on CAN DIAG SUPPORT MNTR (with PAST), "1 - 39" is indicated on "PAST" of "TRANSMIT DIAG" and the reception item.	

# TROUBLE DIAGNOSES WORK FLOW

< SERVICE INFORMATION >

[CAN FUNDAMENTAL]

(Example)

DTC RESULTS	TIME	DTC RESULTS	TIME	DTC RESULTS	TIME	DTC RESULTS	TIME
ENGINE		ADAPTIVE LIGHT		MULTI AV		BCM	
U1000 : CAN COMM CIRCUIT	1t	U1000 : CAN COMM CIRCUIT	5	U1000 : CAN COMM CIRCUIT	5	U1000 : CAN COMM CIRCUIT	5
U1001 : CAN COMM CIRCUIT	1t						

DTC RESULTS	TIME	DTC RESULTS	TIME	DTC RESULTS	TIME	DTC RESULTS	TIME
EPS		INTELLIGENT KEY		METER		AUTO DRIVE POS.	
U1000 : CAN COMM CIRCUIT	5	U1000 : CAN COMM CIRCUIT	5	U1000 : CAN COMM CIRCUIT	5	U1000 : CAN COMM CIRCUIT	PAST

“U1000” and “U1001” is indicated in the past for most units.

ECM	AFS	AV	BCM
PRSENT	PAST	PRSENT	PAST
TRANSMIT DIAG	OK 5	TRANSMIT DIAG	- -
VDC/TCS/ABS	OK 5	ECM	OK 5
METER/M&A	OK 5	METER/M&A	OK 5
BCM/SEC	OK 5	TCM	OK 5
ICC	- -	STRG	OK 5
HVAC	- -	EPS	- -
TCM	OK 5	IPDM E/R	OK 5
EPS	OK 5	TIRE-P	- -
IPDM E/R	OK 5		
e4WD	- -		
AWD/4WD	- -		

Only on CAN DIAG SUPPORT MNTR (with PAST), “1-39” is indicated on “PAST” of “TRANSMIT DIAG” and the reception item.

EPS	I-KEY	M&A	ADP
PRSENT	PAST	PRSENT	PAST
TRANSMIT DIAG	OK 5	TRANSMIT DIAG	OK 5
ECM	OK 5	ECM	OK 5
VDC/TCS/ABS	OK 5	METER/M&A	OK 5
METER/M&A	OK 5	TCM	OK 5
		BCM/SEC	OK 5
		VDC/TCS/ABS	OK 5
		IPDM E/R	- -
			- -
			OK 5
			5

PKID1225E

# INDEX FOR DTC

< SERVICE INFORMATION >

[CAN]

## SERVICE INFORMATION

### INDEX FOR DTC

DTC No. Index

INFOID:000000001719329

DTC	Self-diagnosis item (CONSULT-III indication)	DTC detection condition	Inspection
U1000	CAN COMM CIRCUIT	When ECM is not transmitting or receiving CAN communication signal of OBD (emission-related diagnosis) for 2 seconds or more.	Refer to <a href="#">LAN-36</a> .
		When a control unit (except for ECM) is not transmitting or receiving CAN communication signal for 2 seconds or more.	
U1001	CAN COMM CIRCUIT	When ECM is not transmitting or receiving CAN communication signal other than OBD (emission-related diagnosis) for 2 seconds or more.	
U1002	SYSTEM COMM	When a control unit is not transmitting or receiving CAN communication signal for 2 seconds or less.	Start the inspection. Refer to the applicable section of the indicated control unit.
U1010	CONTROL UNIT [CAN]	When an error is detected during the initial diagnosis for CAN controller of each control unit.	Replace the control unit indicating "U1010".

A  
B  
C  
D  
E  
F  
G  
H  
I  
J  
L  
M  
N  
O  
P

LAN

# HOW TO USE THIS SECTION

< SERVICE INFORMATION >

[CAN]

## HOW TO USE THIS SECTION

### Caution

INFOID:000000001719330

- This section describes information peculiar to a vehicle, sheets for trouble diagnosis, and inspection procedures.
- For trouble diagnosis procedure, refer to [LAN-13, "Trouble Diagnosis Procedure"](#).

### Abbreviation List

INFOID:000000001719331

Abbreviations in CAN communication signal chart, and the diagnosis sheet are as per the following list.

Abbreviation	Unit name	SELECT SYSTEM (CONSULT-III)	CAN DIAG SUPPORT MNTR (CONSULT-III)
A-BAG	Air bag diagnosis sensor unit	AIR BAG	–
ABS	ABS actuator and electric unit (control unit)	ABS	VDC/TCS/ABS
ADP	Driver seat control unit	AUTO DRIVE POS.	–
BCM	BCM	BCM	BCM/SEC
DISP	Display unit	–	–
	Display control unit	–	DISPLAY
DLC	Data link connector	–	–
ECM	ECM	ENGINE	ECM
HVAC	Front air control	HVAC	HVAC
IPDM-E	IPDM E/R	IPDM E/R	IPDM E/R
M&A	Combination meter	METER/M&A	METER/M&A
STRG	Steering angle sensor	–	STRG
TCM	TCM	TRANSMISSION	TCM

# PRECAUTIONS

< SERVICE INFORMATION >

[CAN]

## PRECAUTIONS

### Precaution for Supplemental Restraint System (SRS) "AIR BAG" and "SEAT BELT PRE-TENSIONER"

INFOID:000000003032428

The Supplemental Restraint System such as "AIR BAG" and "SEAT BELT PRE-TENSIONER", used along with a front seat belt, helps to reduce the risk or severity of injury to the driver and front passenger for certain types of collision. This system includes seat belt switch inputs and dual stage front air bag modules. The SRS system uses the seat belt switches to determine the front air bag deployment, and may only deploy one front air bag, depending on the severity of a collision and whether the front occupants are belted or unbelted. Information necessary to service the system safely is included in the "SRS AIRBAG" and "SEAT BELT" of this Service Manual.

#### WARNING:

- To avoid rendering the SRS inoperative, which could increase the risk of personal injury or death in the event of a collision which would result in air bag inflation, all maintenance must be performed by an authorized NISSAN/INFINITI dealer.
- Improper maintenance, including incorrect removal and installation of the SRS, can lead to personal injury caused by unintentional activation of the system. For removal of Spiral Cable and Air Bag Module, see the "SRS AIRBAG".
- Do not use electrical test equipment on any circuit related to the SRS unless instructed to in this Service Manual. SRS wiring harnesses can be identified by yellow and/or orange harnesses or harness connectors.

### Precaution for Trouble Diagnosis

INFOID:000000001719334

#### CAUTION:

- Never apply 7.0 V or more to the measurement terminal.
- Use a tester with open terminal voltage of 7.0 V or less.
- Turn the ignition switch OFF and disconnect the battery cable from the negative terminal when checking the harness.

### Precaution for Harness Repair

INFOID:000000001719335

- Solder the repaired area and wrap tape around the soldered area.

#### NOTE:

A fray of twisted lines must be within 110 mm (4.33 in).

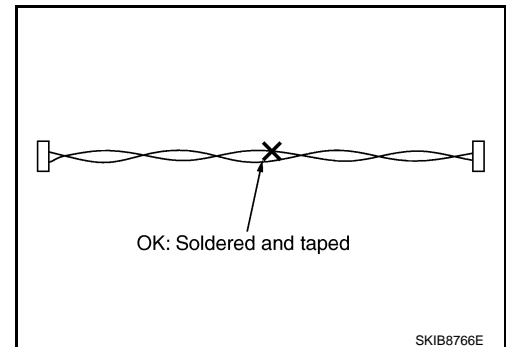

- Bypass connection is never allowed at the repaired area.

#### NOTE:

Bypass connection may cause CAN communication error. The spliced wire becomes separated and the characteristics of twisted line are lost.

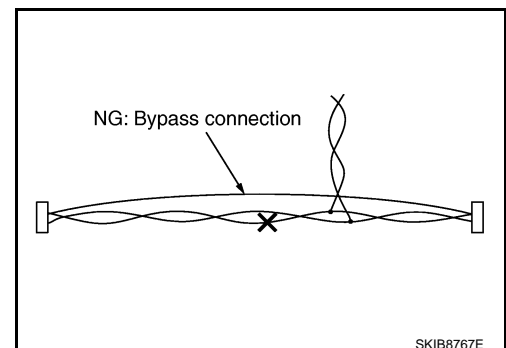

- Replace the applicable harness as an assembly if error is detected on the shield lines of CAN communication line.

A  
B  
C  
D  
E  
F  
G  
H  
I  
J  
LAN  
L  
M  
N  
O  
P

# TROUBLE DIAGNOSIS

[CAN]

< SERVICE INFORMATION >

## TROUBLE DIAGNOSIS

### CAN Diagnostic Support Monitor

INFOID:000000001719336

Use "CAN DIAG SUPPORT MNTR" for detecting the root cause.

#### MONITOR ITEM LIST (CONSULT-III)

##### ECM

0: Error at present, 1 – 39: Error in the past (Number means the number of times the ignition switch is turned OFF→ON)

ITEM	CAN DIAG SUP-PORT MNTR	Description	Normal		Error	
			PRSNT	PAST	PRSNT	PAST
ECM	TRANSMIT DIAG	Signal transmission status	OK	OK or 1 – 39*	UNKWN	0
	VDC/TCS/ABS	Signal receiving status from the ABS actuator and electric unit (control unit)				
	METER/M&A	Signal receiving status from the combination meter				
	BCM/SEC	Signal receiving status from the BCM				
	ICC	Not used even though indicated				
	HVAC					
	TCM	Signal receiving status from the TCM	OK	OK or 1 – 39*	UNKWN	0
	EPS	Not used even though indicated				
	IPDM E/R	Signal receiving status from the IPDM E/R	OK	OK or 1 – 39*	UNKWN	0
	e4WD	Not used even though indicated				
AWD/4WD						

\*: 39 or higher number is fixed at 39 until the self-diagnosis result is erased.

#### ABS Actuator and Electric Unit (Control Unit)

- Models with TCS

ITEM	CAN DIAG SUP-PORT MNTR	Description	Normal	Error
			PRSNT	
ABS	INITIAL DIAG	Status of CAN controller	OK	NG <sup>Caution</sup>
	TRANSMIT DIAG	Signal transmission status		
	ECM	Signal receiving status from the ECM		
	TCM	Signal receiving status from the TCM		

**CAUTION:**

Never replace the unit even when "NG" is indicated on the "INITIAL DIAG" at this stage. Follow the trouble diagnosis procedures.

- Models with VDC

# TROUBLE DIAGNOSIS

< SERVICE INFORMATION >

[CAN]

ITEM	CAN DIAG SUP- PORT MNTR	Description	Normal	Error		
			PRSNT			
ABS	INITIAL DIAG	Status of CAN controller	OK	NG <sup>Caution</sup>		
	TRANSMIT DIAG	Signal transmission status		UNKWN		
	ECM	Signal receiving status from the ECM				
	TCM	Signal receiving status from the TCM				
	METER/M&A	Not used even though indicated				
	STRG	Signal receiving status from the steering angle sensor			OK	UNKWN
	ICC	Not used even though indicated				

**CAUTION:**

Never replace the unit even when “NG” is indicated on the “INITIAL DIAG” at this stage. Follow the trouble diagnosis procedures.

TCM

**NOTE:**

Replace the unit when “NG” is indicated on the “INITIAL DIAG”.

ITEM	CAN DIAG SUP- PORT MNTR	Description	Normal	Error
			PRSNT	
TCM	INITIAL DIAG	Status of CAN controller	OK	NG
	TRANSMIT DIAG	Signal transmission status		UNKWN
	ECM	Signal receiving status from the ECM		
	VDC/TCS/ABS	Signal receiving status from the ABS actuator and electric unit (control unit)		
	METER/M&A	Signal receiving status from the combination meter		

Driver Seat Control Unit

0: Error at present, 1 – 39: Error in the past (Number means the number of times the ignition switch is turned OFF→ON)

ITEM	CAN DIAG SUP- PORT MNTR	Description	Normal		Error	
			PRSNT	PAST	PRSNT	PAST
			ADP	TRANSMIT DIAG	Not used even though indicated	
METER/M&A	Signal receiving status from the combination meter	OK		OK or 1 – 39*	UNKWN	0
BCM/SEC	Signal receiving status from the BCM					
TCM	Signal receiving status from the TCM					

\*: 39 or higher number is fixed at 39 until the self-diagnosis result is erased.

BCM

**NOTE:**

Replace the unit when “NG” is indicated on the “INITIAL DIAG”.

ITEM	CAN DIAG SUP- PORT MNTR	Description	Normal	Error
			PRSNT	
BCM	INITIAL DIAG	Status of CAN controller	OK	NG
	TRANSMIT DIAG	Signal transmission status		UNKWN
	ECM	Signal receiving status from the ECM		
	IPDM E/R	Signal receiving status from the IPDM E/R		
	METER/M&A	Signal receiving status from the combination meter		
	I-KEY	Not used even though indicated		

Front Air Control

A  
B  
C  
D  
E  
F  
G  
H  
I  
J  
L  
M  
N  
O  
P

LAN

# TROUBLE DIAGNOSIS

[CAN]

## < SERVICE INFORMATION >

0: Error at present, 1 – 39: Error in the past (Number means the number of times the ignition switch is turned OFF→ON)

ITEM	CAN DIAG SUP-PORT MNTR	Description	Normal		Error	
			PRSNT	PAST	PRSNT	PAST
HVAC	TRANSMIT DIAG	Signal transmission status	OK	OK or 1 – 39*	UNKWN	0
	ECM	Signal receiving status from the ECM				
	TCM	Not used even though indicated				
	BCM/SEC	Signal receiving status from the BCM	OK	OK or 1 – 39*	UNKWN	0
	VDC/TCS/ABS	Signal receiving status from the ABS actuator and electric unit (control unit)				
	IPDM E/R	Not used even though indicated				
	DISPLAY	Signal receiving status from the display control unit	OK	OK or 1 – 39*	UNKWN	0
	I-KEY	Not used even though indicated				
	EPS					
	AWD/4WD					
	e4WD					
	ICC					
	LANE KEEP					
TIRE-P						

\*: 39 or higher number is fixed at 39 until the self-diagnosis result is erased.

### Combination Meter

0: Error at present, 1 – 39: Error in the past (Number means the number of times the ignition switch is turned OFF→ON)

ITEM	CAN DIAG SUP-PORT MNTR	Description	Normal		Error	
			PRSNT	PAST	PRSNT	PAST
M&A	TRANSMIT DIAG	Signal transmission status	OK	OK or 1 – 39*	UNKWN	0
	ECM	Signal receiving status from the ECM				
	TCM	Signal receiving status from the TCM				
	BCM/SEC	Signal receiving status from the BCM				
	VDC/TCS/ABS	Signal receiving status from the ABS actuator and electric unit (control unit)				
	IPDM E/R	Signal receiving status from the IPDM E/R				
	DISPLAY	Not used even though indicated				
	I-KEY					
	EPS					
	AWD/4WD					
	e4WD					
	ICC					
	LANE KEEP					
TIRE-P						

\*: 39 or higher number is fixed at 39 until the self-diagnosis result is erased.

IPDM E/R



# TROUBLE DIAGNOSIS

[CAN]

## < SERVICE INFORMATION >

0: Error at present, 1 – 39: Error in the past (Number means the number of times the ignition switch is turned OFF→ON)

ITEM	CAN DIAG SUP-PORT MNTR	Description	Normal		Error	
			PRSNT	PAST	PRSNT	PAST
IPDM-E	TRANSMIT DIAG	Signal transmission status	OK	OK or 1 – 39*	UNKWN	0
	ECM	Signal receiving status from the ECM				
	BCM/SEC	Signal receiving status from the BCM				

\*: 39 or higher number is fixed at 39 until the self-diagnosis result is erased.

## MONITOR ITEM LIST (ON-BOARD DIAGNOSIS)

Display Control Unit

### NOTE:

CAN diagnostic support monitor of the display control unit is indicated on the vehicle display. Refer to the following.

- Models with color display: Refer to [AV-145, "CAN Communication Line Check \(With Color Display\)"](#).
- Models with navigation system: Refer to [AV-193, "CAN Communication Line Check"](#).

(Example)

CAN DIAG SUPPORT MONITOR			
CAN_COMM	OK	0	<input type="button" value="Delete"/>
CAN_CIRC_1	OK	0	
CAN_CIRC_2	OK	0	
CAN_CIRC_3	OK	0	
CAN_CIRC_4	OK	0	
CAN_CIRC_5	OK	0	
CAN_CIRC_6	OK	0	
CAN_CIRC_7	OK	0	
CAN_CIRC_8	OK	0	
CAN_CIRC_9	UNKWN	0	

PKIB6080E

Unit name	Diagnosis item	Description	Indicated items on CAN DIAG SUPPORT MONITOR			
			Normal		Error	
			Result indicated	Error counter (Reference)	Result indicated	Error counter (Reference)
Display control unit	CAN_COMM	Status of CAN controller	OK	0 or 1 – 50*	NG	1 – 50*
	CAN_CIRC_1	Signal transmission status				
	CAN_CIRC_2	Signal receiving status from the BCM				
	CAN_CIRC_3	Signal receiving status from the ECM				
	CAN_CIRC_4	Signal receiving status from the front air control				
	CAN_CIRC_5	Signal receiving status from the combination meter				
	CAN_CIRC_6	Not used even though indicated				
	CAN_CIRC_7	Signal receiving status from the IPDM E/R	OK	0 or 1 – 50*	UNKWN	1 – 50*
	CAN_CIRC_8	Not used even though indicated				
	CAN_CIRC_9					

\*: The error counter stops counting when it reaches "50" and holds "50" until it is deleted.

## CAN System Specification Chart

INFOID:000000001719337

Determine CAN system type from the following specification chart. Then choose the correct diagnosis sheet.

### NOTE:

# TROUBLE DIAGNOSIS

[CAN]

< SERVICE INFORMATION >

Refer to [LAN-13. "Trouble Diagnosis Procedure"](#) for how to use CAN system specification chart.

Body type	Wagon		
Axle	2WD		
Engine	VQ35DE		
Transmission	A/T		
Brake control	TCS		VDC
Automatic drive positioner			X
Color display		X	X
Monochrome display	X		
CAN system type	1	2	3
Diagnosis sheet	<a href="#">LAN-53</a>	<a href="#">LAN-54</a>	<a href="#">LAN-55</a>
CAN communication signal chart	"TYPE 1/TYPE 2"		"TYPE 3"

X: Applicable

## VEHICLE EQUIPMENT IDENTIFICATION INFORMATION

### NOTE:

Check CAN system type from the vehicle shape and equipment.

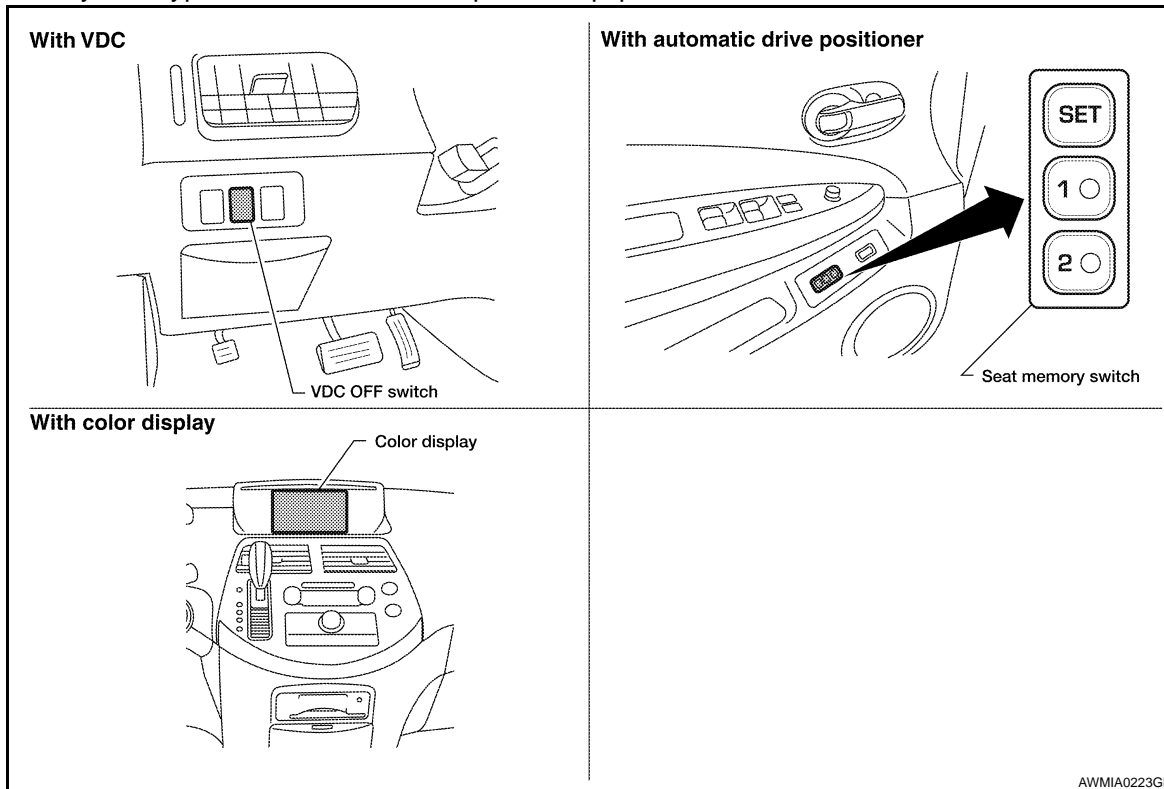

## CAN Communication Signal Chart

INFOID:000000001719338

Refer to [LAN-12. "How to Use CAN Communication Signal Chart"](#) for how to use CAN communication signal chart.

TYPE 1/TYPE 2

### NOTE:

Refer to [LAN-36. "Abbreviation List"](#) for the abbreviations of the connecting units.

# TROUBLE DIAGNOSIS

< SERVICE INFORMATION >

[CAN]

T: Transmit R: Receive

Signal name/Connecting unit	ECM	ABS	TCM	BCM	DISP*	HVAC	M&A	IPDM-E	A
A/C compressor request signal	T							R	B
Accelerator pedal position signal	T	R	R						
ASCD CRUISE indicator signal	T						R		C
ASCD OD cancel request signal	T		R						
ASCD operation signal	T		R						
ASCD SET indicator signal	T						R		D
Cooling fan speed request signal	T							R	
Engine and A/T integrated control signal	T		R						
	R		T						E
Engine coolant temperature signal	T		R			R	R		
Engine speed signal	T	R	R		R	R	R		F
Fuel consumption monitor signal	T						R		
					R		T		
Malfunction indicator lamp signal	T						R		G
A/T shift schedule change demand signal		T	R						
ABS operation signal		T	R						H
ABS warning lamp signal		T					R		
Brake warning lamp signal		T					R		
SLIP indicator lamp signal		T					R		I
Stop lamp switch signal		T	R						
TCS OFF indicator lamp signal		T					R		J
TCS operation signal		T	R						
Vehicle speed signal		T				R	R		
	R		R	R	R		T		LAN
A/T self-diagnosis signal	R		T						
O/D OFF indicator lamp signal			T				R		
Output shaft revolution signal	R		T						L
P range signal		R	T						
Shift position signal			T				R		M
Turbine revolution signal	R		T						
A/C switch signal	R			T		R			
Blower fan motor switch signal	R			T					N
Buzzer output signal				T			R		
Cornering lamp request signal				T				R	O
Door switch signal				T	R		R	R	
Front fog light request signal				T				R	
Front wiper request signal				T				R	P
High beam request signal				T			R	R	
Horn chirp signal				T				R	
Ignition switch signal				T				R	
Low beam request signal				T				R	
Position light request signal				T			R	R	

# TROUBLE DIAGNOSIS

< SERVICE INFORMATION >

[CAN]

Signal name/Connecting unit	ECM	ABS	TCM	BCM	DISP*	HVAC	M&A	IPDM-E
Rear window defogger switch signal				T	R	R		R
Sleep wake up signal				T			R	R
System setting signal				T	R			
				R	T			
Tire pressure data signal				T	R			
Tire pressure signal				T			R	
Turn indicator signal				T			R	
A/C switch/indicator signal					T	R		
					R	T		
BCM wake up request signal				R			T	T
Distance to empty signal					R		T	
Fuel level sensor signal	R						T	
Seat belt buckle switch signal				R			T	
Cooling fan speed signal	R							T
Front wiper stop position signal				R				T
High beam status signal	R							T
Ignition power supply confirmation signal				R				T
IPDM E/R refuse to sleep signal				R				T
IPDM E/R wake up sleep request signal				R				T
Low beam status signal	R							T
Oil pressure switch signal							R	T
Rear window defogger control signal	R							T

\*: Models with color display

**NOTE:**

CAN data of the air bag diagnosis sensor unit is not used by usual service work, thus it is omitted.

**TYPE 3**

**NOTE:**

Refer to [LAN-36. "Abbreviation List"](#) for the abbreviations of the connecting units.

T: Transmit R: Receive

Signal name/Connecting unit	ECM	ABS	TCM	ADP	BCM	DISP	HVAC	M&A	STRG	IPDM-E
A/C compressor request signal	T									R
Accelerator pedal position signal	T	R	R							
ASCD CRUISE indicator signal	T							R		
ASCD OD cancel request signal	T		R							
ASCD operation signal	T		R							
ASCD SET indicator signal	T							R		
Cooling fan speed request signal	T									R
Engine and A/T integrated control signal	T		R							
	R		T							
Engine coolant temperature signal	T		R				R	R		
Engine speed signal	T	R	R			R	R	R		

# TROUBLE DIAGNOSIS

< SERVICE INFORMATION >

[CAN]

Signal name/Connecting unit	ECM	ABS	TCM	ADP	BCM	DISP	HVAC	M&A	STRG	IPDM-E
Fuel consumption monitor signal	T					R		R		
Malfunction indicator lamp signal	T							R		
A/T shift schedule change demand signal		T	R							
ABS operation signal		T	R							
ABS warning lamp signal		T						R		
Brake warning lamp signal		T						R		
SLIP indicator lamp signal		T						R		
Stop lamp switch signal		T	R							
Vehicle speed signal	R	T		R	R	R	R	R		
VDC OFF indicator lamp signal		T						R		
VDC operation signal		T	R							
A/T self-diagnosis signal	R		T							
O/D OFF indicator lamp signal			T					R		
Output shaft revolution signal	R		T							
P range signal		R	T	R						
R range signal		R	T	R						
Shift position signal			T					R		
Turbine revolution signal	R		T							
System setting signal				T	T	R				
A/C switch signal	R			R	R	T	R			
Blower fan motor switch signal	R				T					
Buzzer output signal					T			R		
Cornering lamp request signal					T					R
Door switch signal				R	T	R		R		R
Front fog light request signal					T					R
Front wiper request signal					T					R
High beam request signal					T			R		R
Horn chirp signal					T					R
Ignition switch signal				R	T					R
Key fob door unlock signal				R	T					
Key fob ID signal				R	T					
Key switch signal				R	T					
Low beam request signal					T					R
Position light request signal					T			R		R
Rear window defogger switch signal					T	R	R			R
Sleep wake up signal					T			R		R
Tire pressure data signal					T	R				
Tire pressure signal					T			R		
Turn indicator signal					T			R		

A  
B  
C  
D  
E  
F  
G  
H  
I  
J  
LAN  
L  
M  
N  
O  
P

## TROUBLE DIAGNOSIS

< SERVICE INFORMATION >

[CAN]

Signal name/Connecting unit	ECM	ABS	TCM	ADP	BCM	DISP	HVAC	M&A	STRG	IPDM-E
A/C switch/indicator signal						T	R			
						R	T			
BCM wake up request signal					R			T		T
Distance to empty signal						R		T		
Fuel level sensor signal	R							T		
Seat belt buckle switch signal					R			T		
Steering angle sensor signal		R							T	
Cooling fan speed signal	R									T
Front wiper stop position signal					R					T
High beam status signal	R									T
Ignition power supply confirmation signal					R					T
IPDM E/R refuse to sleep signal					R					T
IPDM E/R wake up sleep request signal					R					T
Low beam status signal	R									T
Oil pressure switch signal								R		T
Rear window defogger control signal	R									T

**NOTE:**

CAN data of the air bag diagnosis sensor unit is not used by usual service work, thus it is omitted.

# TROUBLE DIAGNOSIS

< SERVICE INFORMATION >

[CAN]

## Schematic

INFOID:000000001719339

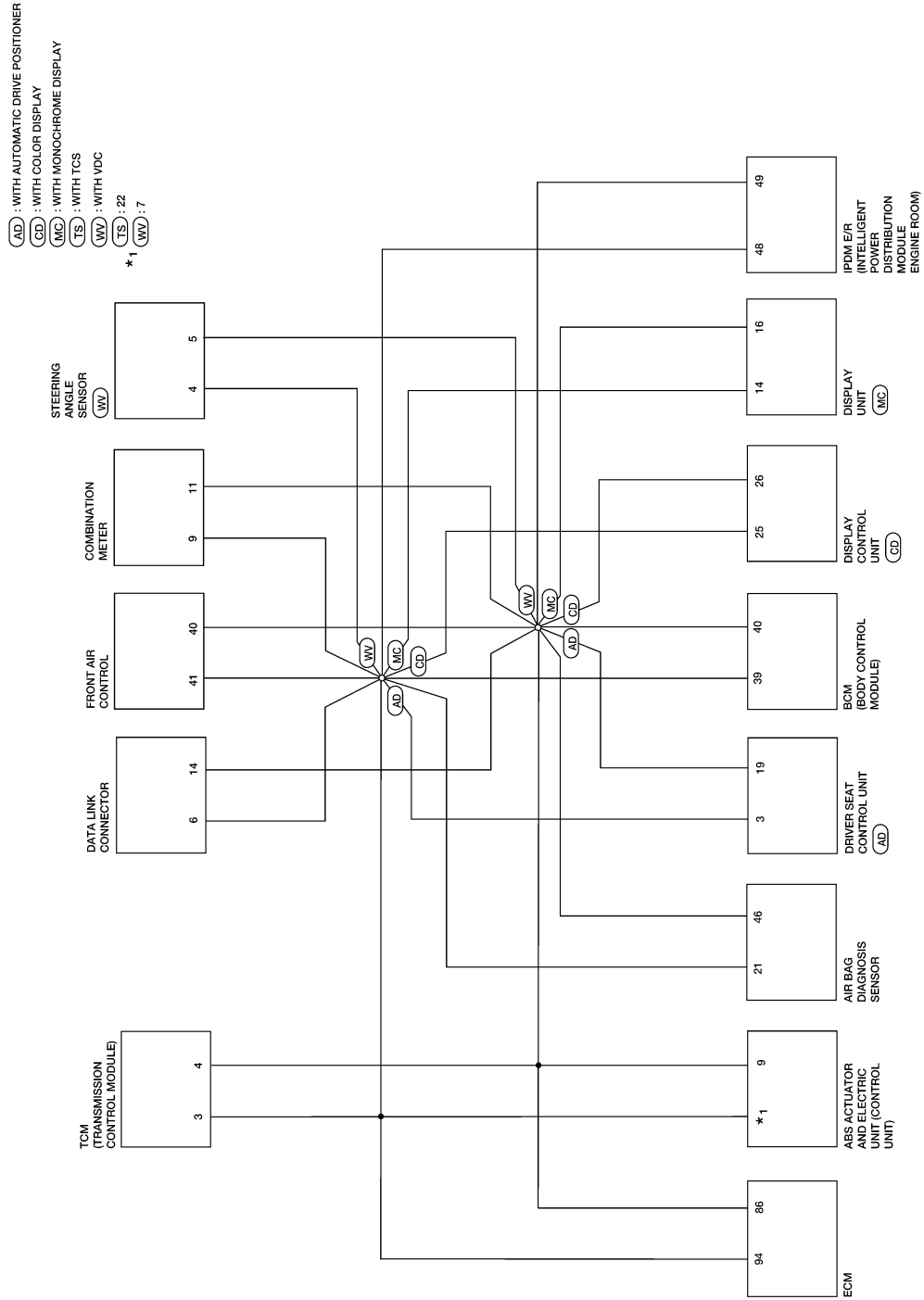

A  
B  
C  
D  
E  
F  
G  
H  
I  
J  
K  
L  
M  
N  
O  
P

LAN

AWMWA0110G

# TROUBLE DIAGNOSIS





< SERVICE INFORMATION >

[CAN]

## Wiring Diagram - CAN -

INFOID:000000001719340

### LAN-CAN-01

-  : DATA LINE
-  : WITH TCS
-  : WITH VDC
- \*1  : 22
-  : 7

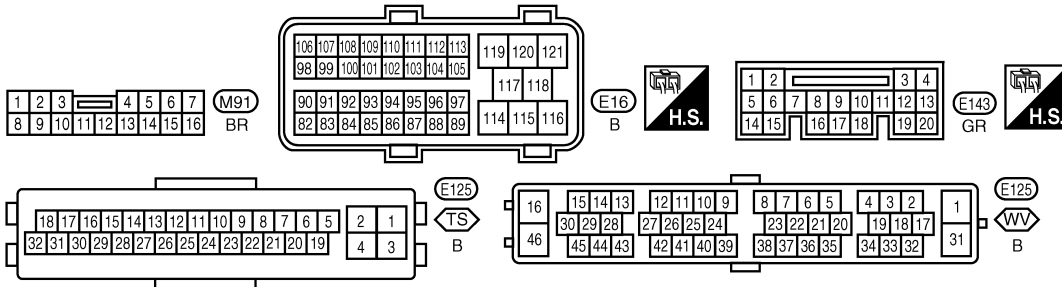
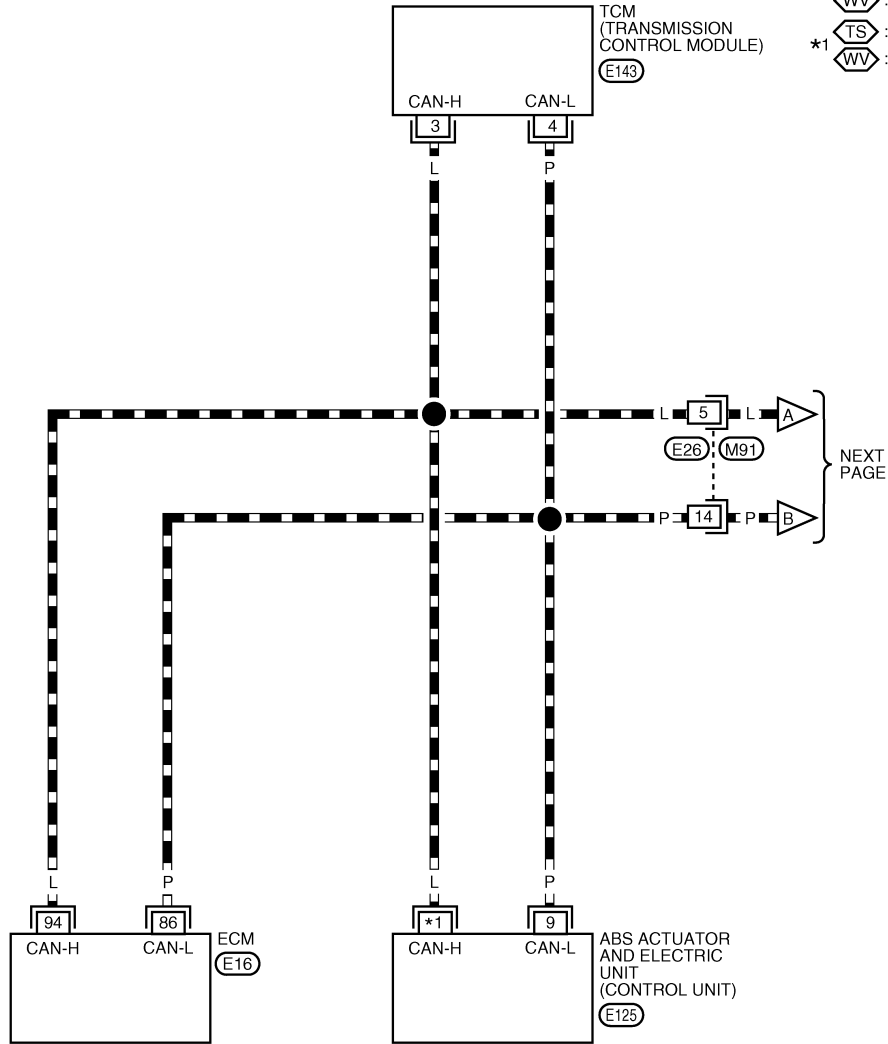

BKWA0693E







# TROUBLE DIAGNOSIS

< SERVICE INFORMATION >

[CAN]

## LAN-CAN-02

-  : DATA LINE
-  : WITH AUTOMATIC DRIVE POSITIONER
-  : WITH COLOR DISPLAY
-  : WITH MONOCHROME DISPLAY
-  : WITH VDC

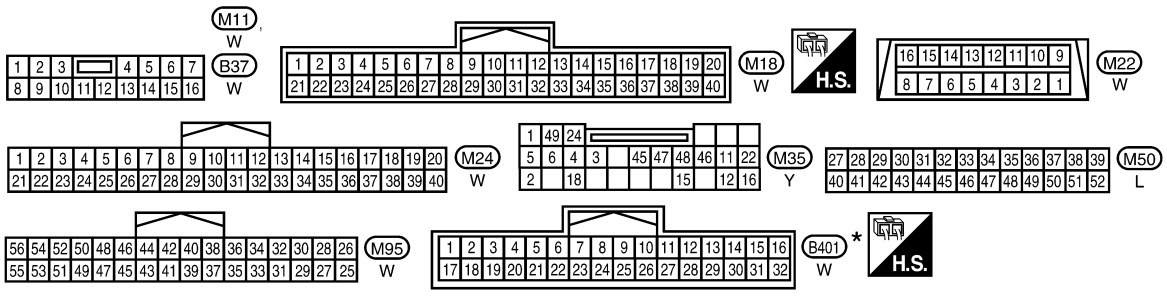
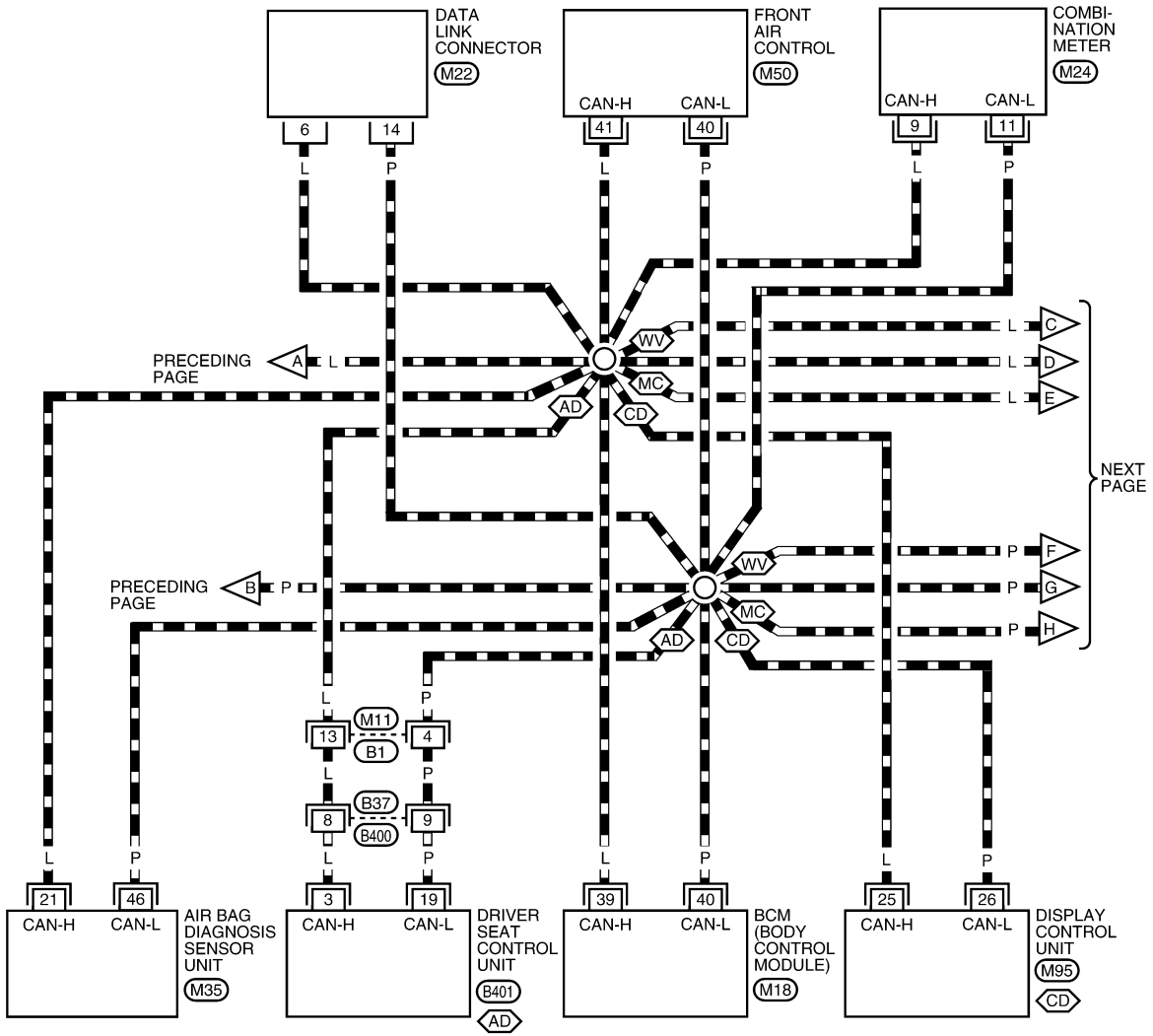

\* : THIS CONNECTOR IS NOT SHOWN IN "HARNESS LAYOUT" OF PG SECTION.

AWMWA0111G1

# TROUBLE DIAGNOSIS

< SERVICE INFORMATION >

[CAN]

## LAN-CAN-03

- : DATA LINE
- MC : WITH MONOCHROME DISPLAY
- WV : WITH VDC

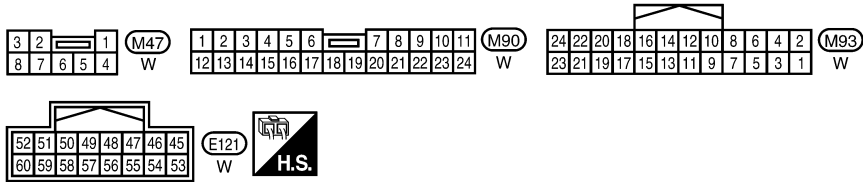
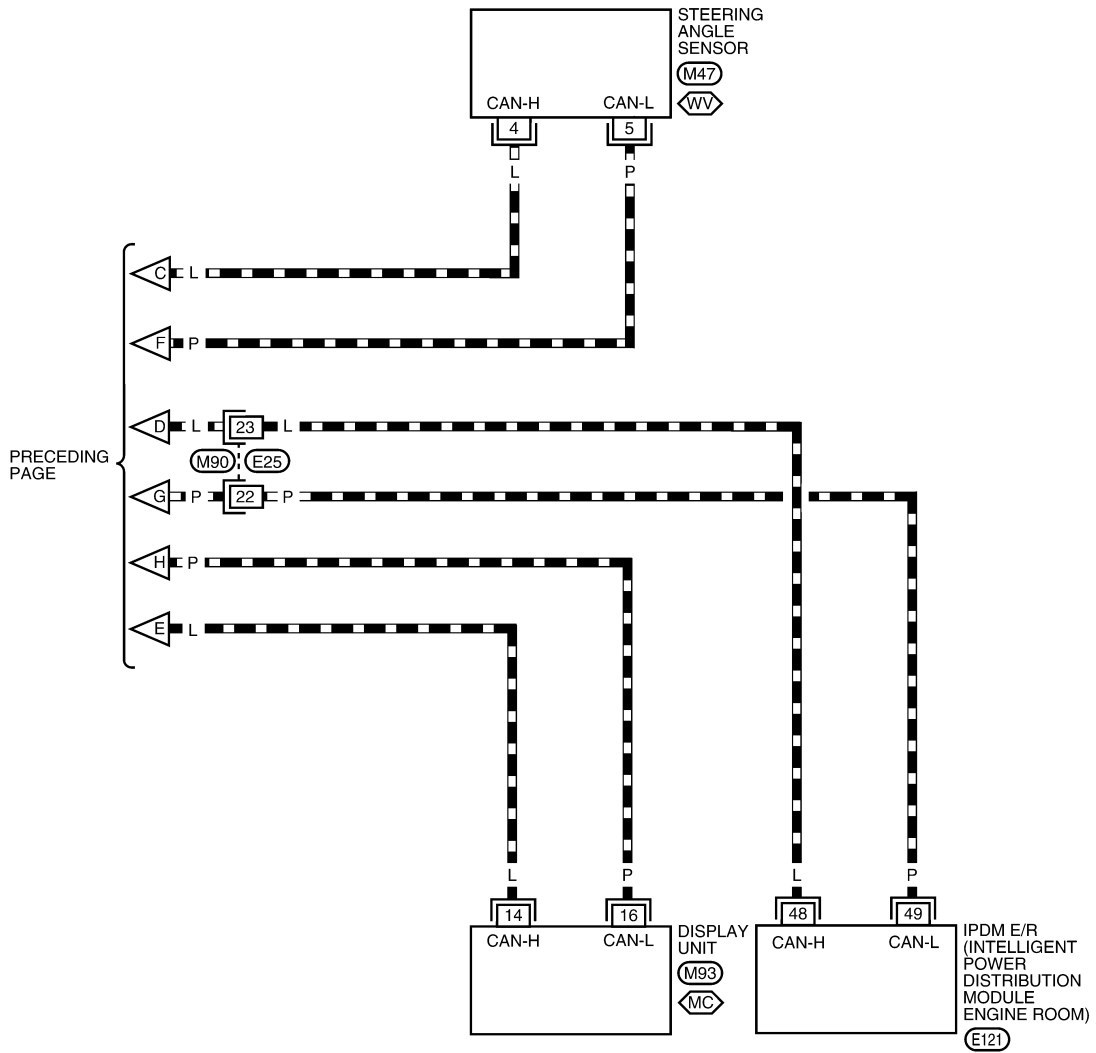

AWMWA0140G

# TROUBLE DIAGNOSIS

< SERVICE INFORMATION >

[CAN]

## Interview Sheet

INFOID:000000001719341

<h3>CAN Communication System Diagnosis Interview Sheet</h3>	
Date received: <input type="text"/>	
Type: <input type="text"/>	VIN No.: <input type="text"/>
Model: <input type="text"/>	
First registration: <input type="text"/>	Mileage: <input type="text"/>
CAN system type: <input type="text"/>	
Symptom (Results from interview with customer)	
<input type="text"/>	
Condition at inspection	
Error symptom : Present / Past <input type="text"/>	
<small>SKIB8898E</small>	

A  
B  
C  
D  
E  
F  
G  
H  
I  
J  
LAN  
L  
M  
N  
O  
P

## Data Sheet

INFOID:000000001719342

### ON-BOARD DIAGNOSIS COPY SHEET

**NOTE:**

CAN diagnostic support monitor of the display control unit is indicated on the vehicle display. Refer to the following.

- Models with color display: Refer to [AV-145, "CAN Communication Line Check \(With Color Display\)"](#).

# TROUBLE DIAGNOSIS

< SERVICE INFORMATION >

[CAN]

- Models with navigation system: Refer to [AV-193. "CAN Communication Line Check"](#).

Vehicle monitor (Display control unit) CAN DIAG SUPPORT MONITOR copy sheet					
Indication item (Diagnosis item)	Vehicle monitor		Indication item (Diagnosis item)	Vehicle monitor	
	Result indicated	Error counter		Result indicated	Error counter
CAN_COMM (Initial diagnosis)			CAN_CIRC_5 (Receive diagnosis of Combination meter)		
CAN_CIRC_1 (Transmit diagnosis)			CAN_CIRC_6	Not available	
CAN_CIRC_2 (Receive diagnosis of BCM)			CAN_CIRC_7 (Receive diagnosis of IPDM E/R)		
CAN_CIRC_3 (Receive diagnosis of ECM)			CAN_CIRC_8	Not available	
CAN_CIRC_4 (Receive diagnosis of Front air control)			CAN_CIRC_9	Not available	

SKIB8771E

# TROUBLE DIAGNOSIS

[CAN]

< SERVICE INFORMATION >

CAN System (Type 1)

INFOID:000000001719343

## DIAGNOSIS SHEET

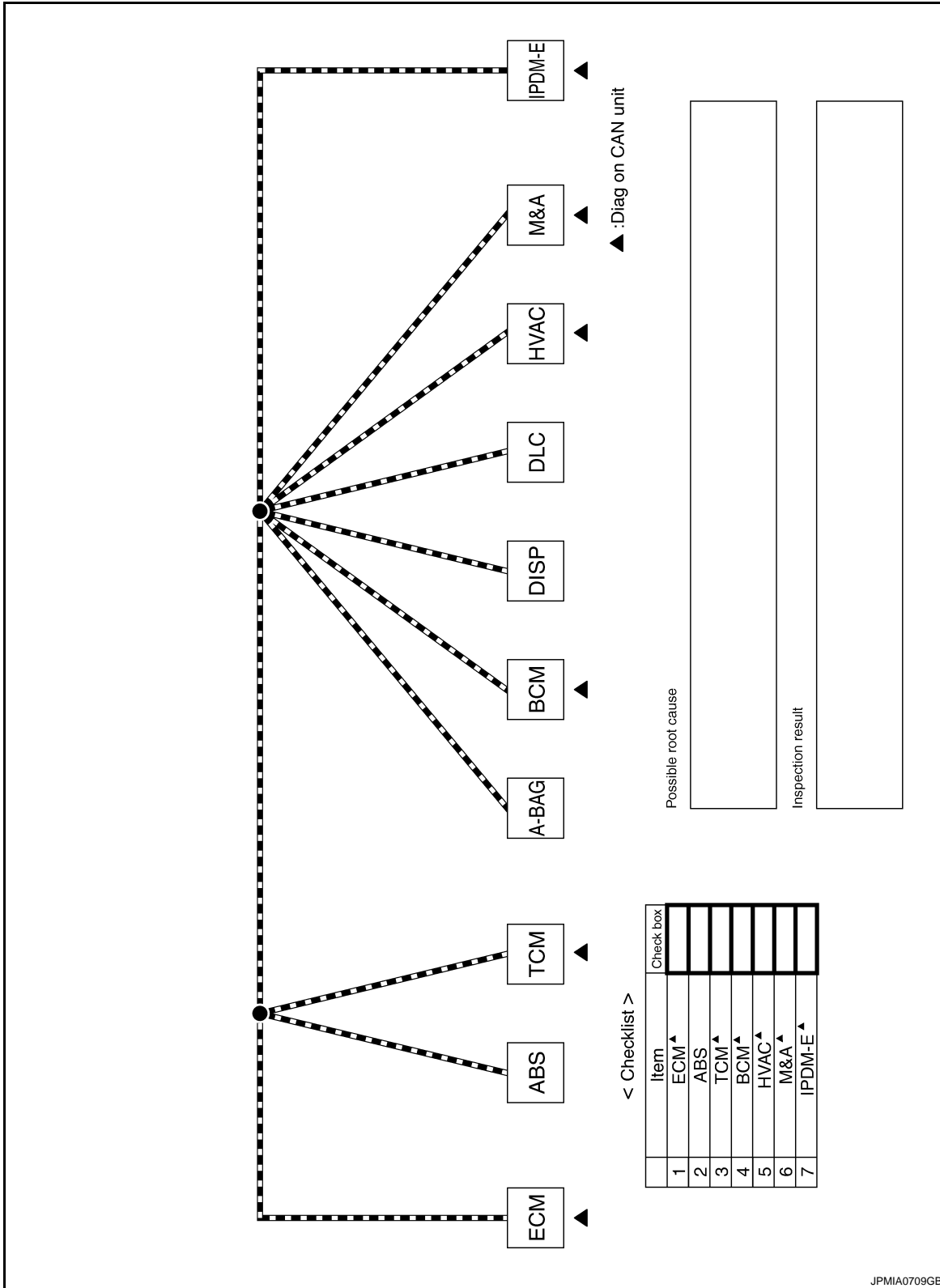

A  
B  
C  
D  
E  
F  
G  
H  
I  
J  
K  
L  
M  
N  
O  
P

LAN

# TROUBLE DIAGNOSIS

[CAN]

< SERVICE INFORMATION >

CAN System (Type 2)

INFOID:000000001719344

## DIAGNOSIS SHEET

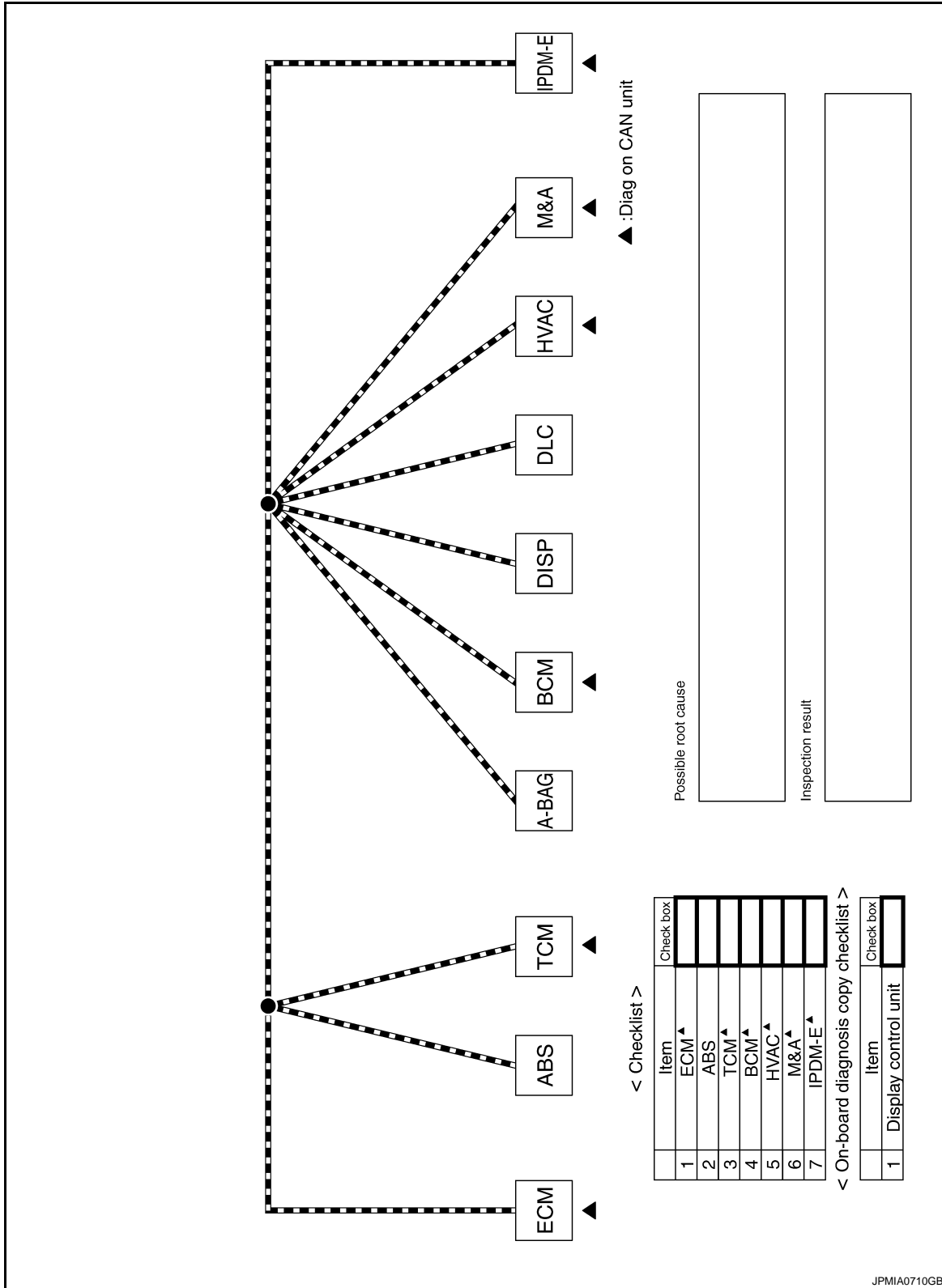

JPMIA0710GB

# TROUBLE DIAGNOSIS

[CAN]

< SERVICE INFORMATION >

CAN System (Type 3)

INFOID:000000001719345

## DIAGNOSIS SHEET

▲ : Diag on CAN unit

< Checklist >

Item	Check box
1	ECM▲
2	ABS
3	TCM▲
4	ADP▲
5	BCM▲
6	HVAC▲
7	M&A▲
8	IPDM-E▲

< On-board diagnosis copy checklist >

Item	Check box
1	Display control unit

Possible root cause

Inspection result

A  
B  
C  
D  
E  
F  
G  
H  
I  
J  
K  
L  
M  
N  
O  
P

LAN

# TROUBLE DIAGNOSIS

< SERVICE INFORMATION >

[CAN]

## Component Parts Location

INFOID:000000001719347

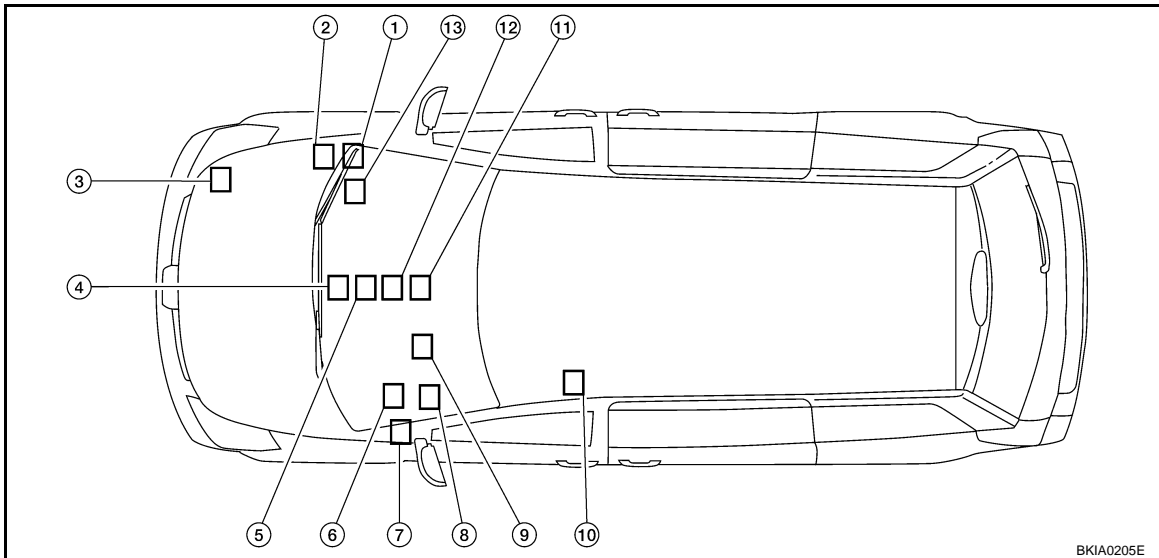

- |                                   |   |                            |
|-----------------------------------|---|----------------------------|
| 1. TCM E143                       | 2. ABS actuator and electric unit (control unit) E125 | 3. IPDM E/R E121           |
| 4. Display control unit M95       | 5. Display unit M93                                   | 6. Combination meter M24   |
| 7. BCM M18                        | 8. Steering angle sensor M47                          | 9. Data link connector M22 |
| 10. Driver seat control unit B401 | 11. Air bag diagnosis sensor unit M35                 | 12. Front air control M50  |
| 13. ECM E16                       |   |                            |

## Harness Layout

INFOID:000000001719348

Refer to [PG-40, "Harness Layout"](#).

## Malfunction Area Chart

INFOID:000000001719349

### MAIN LINE

Malfunction Area	Reference
Main line between TCM and data link connector	<a href="#">LAN-57, "Main Line Between TCM and Data Link Connector"</a>

### BRANCH LINE

Malfunction Area	Reference
ECM branch line circuit	<a href="#">LAN-58, "ECM Branch Line Circuit"</a>
ABS actuator and electric unit (control unit) branch line circuit	<a href="#">LAN-58, "ABS Actuator and Electric Unit (Control Unit) Branch Line Circuit"</a>
TCM branch line circuit	<a href="#">LAN-59, "TCM Branch Line Circuit"</a>
Driver seat control unit branch line circuit	<a href="#">LAN-59, "Driver Seat Control Unit Branch Line Circuit"</a>
BCM branch line circuit	<a href="#">LAN-60, "BCM Branch Line Circuit"</a>
Display control unit branch line circuit	<a href="#">LAN-61, "Display Control Unit Branch Line Circuit"</a>
Display unit branch line circuit	<a href="#">LAN-61, "Display Unit Branch Line Circuit"</a>
Data link connector branch line circuit	<a href="#">LAN-62, "Data Link Connector Branch Line Circuit"</a>
Front air control branch line circuit	<a href="#">LAN-62, "Front Air Control Branch Line Circuit"</a>
Combination meter branch line circuit	<a href="#">LAN-63, "Combination Meter Branch Line Circuit"</a>



# TROUBLE DIAGNOSIS

[CAN]

## < SERVICE INFORMATION >

Malfunction Area	Reference
Steering angle sensor branch line circuit	<a href="#">LAN-64, "Steering Angle Sensor Branch Line Circuit"</a>
IPDM E/R branch line circuit	<a href="#">LAN-64, "IPDM E/R Branch Line Circuit"</a>

## SHORT CIRCUIT

Malfunction Area	Reference
CAN communication circuit	<a href="#">LAN-65, "CAN Communication Circuit"</a>

## Main Line Between TCM and Data Link Connector

INFOID:000000001719350

### INSPECTION PROCEDURE

#### 1. CHECK CONNECTOR

1. Turn the ignition switch OFF.
2. Disconnect the battery cable from the negative terminal.
3. Check the following terminals and connectors for damage, bend and loose connection (connector side and harness side).
  - Harness connector E26
  - Harness connector M91

#### OK or NG

- OK >> GO TO 2.  
 NG >> Repair the terminal and connector.

#### 2. CHECK HARNESS CONTINUITY (OPEN CIRCUIT)

1. Disconnect the harness connectors E26 and M91.
2. Check the continuity between the TCM harness connector and the harness connector.

TCM harness connector		Harness connector		Continuity
Connector No.	Terminal No.	Connector No.	Terminal No.	
E143	3	E26	5	Yes
	4		14	Yes

#### OK or NG

- OK >> GO TO 3.  
 NG >> Repair the main line between the TCM and the harness connector E26.

#### 3. CHECK HARNESS CONTINUITY (OPEN CIRCUIT)

Check the continuity between the harness connector and the data link connector.

Harness connector		Data link connector		Continuity
Connector No.	Terminal No.	Connector No.	Terminal No.	
M91	5	M22	6	Yes
	14		14	Yes

#### OK or NG

- OK >> • Present error: Check the following items again.
- Decision of CAN system type.
  - Not received CONSULT-III data [SELF-DIAG RESULTS, CAN DIAG SUPPORT MNTR ("ECU list" included)].
  - Not copied from on-board diagnosis.
  - Procedure for detecting root cause.
  - Past error: Error was detected in the main line between the TCM and the data link connector.
- NG >> Repair the main line between the harness connector M91 and the data link connector.

# TROUBLE DIAGNOSIS

[CAN]

< SERVICE INFORMATION >

## ECM Branch Line Circuit

INFOID:000000001719351

### INSPECTION PROCEDURE

#### 1. CHECK CONNECTOR

1. Turn the ignition switch OFF.
2. Disconnect the battery cable from the negative terminal.
3. Check the terminals and connectors of the ECM for damage, bend and loose connection (unit side and connector side).

#### OK or NG

- OK >> GO TO 2.  
NG >> Repair the terminal and connector.

#### 2. CHECK HARNESS FOR OPEN CIRCUIT

1. Disconnect the connector of ECM.
2. Check the resistance between the ECM harness connector terminals.

ECM harness connector			Resistance ( $\Omega$ )
Connector No.	Terminal No.		
E16	94	86	Approx. 108 – 132

#### OK or NG

- OK >> GO TO 3.  
NG >> Repair the ECM branch line.

#### 3. CHECK POWER SUPPLY AND GROUND CIRCUIT

Check the power supply and the ground circuit of the ECM. Refer to [EC-131, "Wiring Diagram"](#).

#### OK or NG

- OK >> • Present error: Replace the ECM. Refer to [EC-72, "Procedure After Replacing ECM"](#).  
• Past error: Error was detected in the ECM branch line.  
NG >> Repair the power supply and the ground circuit.

## ABS Actuator and Electric Unit (Control Unit) Branch Line Circuit

INFOID:000000001719352

### INSPECTION PROCEDURE

#### 1. CHECK CONNECTOR

1. Turn the ignition switch OFF.
2. Disconnect the battery cable from the negative terminal.
3. Check the terminals and connectors of the ABS actuator and electric unit (control unit) for damage, bend and loose connection (unit side and connector side).

#### OK or NG

- OK >> GO TO 2.  
NG >> Repair the terminal and connector.

#### 2. CHECK HARNESS FOR OPEN CIRCUIT

1. Disconnect the connector of ABS actuator and electric unit (control unit).
2. Check the resistance between the ABS actuator and electric unit (control unit) harness connector terminals.
  - Models with TCS

ABS actuator and electric unit (control unit) harness connector			Resistance ( $\Omega$ )
Connector No.	Terminal No.		
E125	22	9	Approx. 54 – 66

- Models with VDC

# TROUBLE DIAGNOSIS

< SERVICE INFORMATION >

[CAN]

ABS actuator and electric unit (control unit) harness connector			Resistance (Ω)
Connector No.	Terminal No.		
E125	7	9	Approx. 54 – 66

## OK or NG

OK >> GO TO 3.

NG >> Repair the ABS actuator and electric unit (control unit) branch line.

## 3.CHECK POWER SUPPLY AND GROUND CIRCUIT

Check the power supply and the ground circuit of the ABS actuator and electric unit (control unit). Refer to the following.

- Models with TCS: [BRC-14, "Schematic"](#)
- Models with VDC: [BRC-54, "Schematic"](#)

## OK or NG

OK >> • Present error: Replace the ABS actuator and electric unit (control unit). Refer to the following.

- Models with TCS: [BRC-41, "Removal and Installation"](#)
- Models with VDC: [BRC-87, "Removal and Installation"](#)

• Past error: Error was detected in the ABS actuator and electric unit (control unit) branch line.

NG >> Repair the power supply and the ground circuit.

## TCM Branch Line Circuit

INFOID:000000001719353

## INSPECTION PROCEDURE

### 1.CHECK CONNECTOR

1. Turn the ignition switch OFF.
2. Disconnect the battery cable from the negative terminal.
3. Check the terminals and connectors of the TCM for damage, bend and loose connection (unit side and connector side).

## OK or NG

OK >> GO TO 2.

NG >> Repair the terminal and connector.

### 2.CHECK HARNESS FOR OPEN CIRCUIT

1. Disconnect the connector of TCM.
2. Check the resistance between the TCM harness connector terminals.

TCM harness connector			Resistance (Ω)
Connector No.	Terminal No.		
E143	3	4	Approx. 54 – 66

## OK or NG

OK >> GO TO 3.

NG >> Repair the TCM branch line.

### 3.CHECK POWER SUPPLY AND GROUND CIRCUIT

Check the power supply and the ground circuit of the TCM. Refer to [AT-49, "Circuit Diagram"](#).

## OK or NG

OK >> • Present error: Replace the TCM. Refer to [AT-47, "A/T Electrical Parts Location"](#).

- Past error: Error was detected in the TCM branch line.

NG >> Repair the power supply and the ground circuit.

## Driver Seat Control Unit Branch Line Circuit

INFOID:000000001719354

## INSPECTION PROCEDURE

### 1.CHECK CONNECTOR

1. Turn the ignition switch OFF.

A  
B  
C  
D  
E  
F  
G  
H  
I  
J  
L  
M  
N  
O  
P

LAN

# TROUBLE DIAGNOSIS

[CAN]

## < SERVICE INFORMATION >

2. Disconnect the battery cable from the negative terminal.
3. Check the following terminals and connectors for damage, bend and loose connection (unit side and connector side).
  - Driver seat control unit
  - Harness connector B400
  - Harness connector B37
  - Harness connector B1
  - Harness connector M11

### OK or NG

- OK >> GO TO 2.  
NG >> Repair the terminal and connector.

## 2.CHECK HARNESS FOR OPEN CIRCUIT

1. Disconnect the connector of driver seat control unit.
2. Check the resistance between the driver seat control unit harness connector terminals.

Driver seat control unit harness connector			Resistance (Ω)
Connector No.	Terminal No.		
B401	3	19	Approx. 54 – 66

### OK or NG

- OK >> GO TO 3.  
NG >> Repair the driver seat control unit branch line.

## 3.CHECK POWER SUPPLY AND GROUND CIRCUIT

Check the power supply and the ground circuit of the driver seat control unit. Refer to [SE-13, "Schematic"](#).

### OK or NG

- OK >> • Present error: Replace the driver seat control unit. Refer to [SE-67, "Removal and Installation"](#).  
• Past error: Error was detected in the driver seat control unit branch line.  
NG >> Repair the power supply and the ground circuit.

## BCM Branch Line Circuit

INFOID:000000001719355

### INSPECTION PROCEDURE

## 1.CHECK CONNECTOR

1. Turn the ignition switch OFF.
2. Disconnect the battery cable from the negative terminal.
3. Check the terminals and connectors of the BCM for damage, bend and loose connection (unit side and connector side).

### OK or NG

- OK >> GO TO 2.  
NG >> Repair the terminal and connector.

## 2.CHECK HARNESS FOR OPEN CIRCUIT

1. Disconnect the connector of BCM.
2. Check the resistance between the BCM harness connector terminals.

BCM harness connector			Resistance (Ω)
Connector No.	Terminal No.		
M18	39	40	Approx. 54 – 66

### OK or NG

- OK >> GO TO 3.  
NG >> Repair the BCM branch line.

## 3.CHECK POWER SUPPLY AND GROUND CIRCUIT

Check the power supply and the ground circuit of the BCM. Refer to [BCS-15, "BCM Power Supply and Ground Circuit Inspection"](#).

# TROUBLE DIAGNOSIS

[CAN]

< SERVICE INFORMATION >

## OK or NG

- OK >> • Present error: Replace the BCM. Refer to [BCS-18, "Removal and Installation of BCM"](#).  
• Past error: Error was detected in the BCM branch line.
- NG >> Repair the power supply and the ground circuit.

## Display Control Unit Branch Line Circuit

INFOID:000000001719356

### INSPECTION PROCEDURE

#### 1.CHECK CONNECTOR

1. Turn the ignition switch OFF.
2. Disconnect the battery cable from the negative terminal.
3. Check the terminals and connectors of the display control unit for damage, bend and loose connection (unit side and connector side).

## OK or NG

- OK >> GO TO 2.
- NG >> Repair the terminal and connector.

#### 2.CHECK HARNESS FOR OPEN CIRCUIT

1. Disconnect the connector of display control unit.
2. Check the resistance between the display control unit harness connector terminals.

Display control unit harness connector			Resistance (Ω)
Connector No.	Terminal No.		
M95	25	26	Approx. 54 – 66

## OK or NG

- OK >> GO TO 3.
- NG >> Repair the display control unit branch line.

#### 3.CHECK POWER SUPPLY AND GROUND CIRCUIT

Check the power supply and the ground circuit of the display control unit. Refer to .

- Models with color display: [AV-130, "Power Supply and Ground Circuit Inspection for Display Control Unit"](#)
- Models with navigation system: [AV-181, "Power Supply and Ground Circuit Inspection for Display Control Unit"](#)

## OK or NG

- OK >> • Present error: Replace the display control unit. Refer to [AV-148, "Removal and Installation"](#).  
• Past error: Error was detected in the display control unit branch line.
- NG >> Repair the power supply and the ground circuit.

## Display Unit Branch Line Circuit

INFOID:000000003032430

### INSPECTION PROCEDURE

#### 1.CHECK CONNECTOR

1. Turn the ignition switch OFF.
2. Disconnect the battery cable from the negative terminal.
3. Check the terminals and connectors of the display unit for damage, bend and loose connection (unit side and connector side).

## OK or NG

- OK >> GO TO 2.
- NG >> Repair the terminal and connector.

#### 2.CHECK HARNESS FOR OPEN CIRCUIT

1. Disconnect the connector of display unit.
2. Check the resistance between the display unit harness connector terminals.

A  
B  
C  
D  
E  
F  
G  
H  
I  
J  
LAN  
L  
M  
N  
O  
P

# TROUBLE DIAGNOSIS

< SERVICE INFORMATION >

[CAN]

Display unit harness connector			Resistance (Ω)
Connector No.	Terminal No.		
M93	14	16	Approx. 54 – 66

OK or NG

- OK >> GO TO 3.  
NG >> Repair the display unit branch line.

## 3.CHECK POWER SUPPLY AND GROUND CIRCUIT

Check the power supply and the ground circuit of the display unit. Refer to [AV-95. "Schematic \(With Mono-chrome Display\)"](#).

OK or NG

- OK >> • Present error: Replace the display unit. Refer to [AV-148. "Removal and Installation"](#).  
• Past error: Error was detected in the display unit branch line.  
NG >> Repair the power supply and the ground circuit.

## Data Link Connector Branch Line Circuit

INFOID:000000001719357

### INSPECTION PROCEDURE

#### 1.CHECK CONNECTOR

1. Turn the ignition switch OFF.
2. Disconnect the battery cable from the negative terminal.
3. Check the terminals and connectors of the data link connector for damage, bend and loose connection (connector side and harness side).

OK or NG

- OK >> GO TO 2.  
NG >> Repair the terminal and connector.

#### 2.CHECK HARNESS FOR OPEN CIRCUIT

Check the resistance between the data link connector terminals.

Data link connector			Resistance (Ω)
Connector No.	Terminal No.		
M22	6	14	Approx. 54 – 66

OK or NG

- OK >> • Present error: Check the following items again.  
- Decision of CAN system type.  
- Not received CONSULT-III data [SELF-DIAG RESULTS, CAN DIAG SUPPORT MNTR ("ECU list" included)].  
- Not copied from on-board diagnosis.  
- Procedure for detecting root cause.  
• Past error: Error was detected in the data link connector branch line circuit.  
NG >> Repair the data link connector branch line.

## Front Air Control Branch Line Circuit

INFOID:000000001719358

### INSPECTION PROCEDURE

#### 1.CHECK CONNECTOR

1. Turn the ignition switch OFF.
2. Disconnect the battery cable from the negative terminal.
3. Check the terminals and connectors of the front air control for damage, bend and loose connection (unit side and connector side).

OK or NG

- OK >> GO TO 2.  
NG >> Repair the terminal and connector.

# TROUBLE DIAGNOSIS

[CAN]

< SERVICE INFORMATION >

## 2.CHECK HARNESS FOR OPEN CIRCUIT

1. Disconnect the connector of front air control.
2. Check the resistance between the front air control harness connector terminals.

Front air control harness connector			Resistance (Ω)
Connector No.	Terminal No.		
M50	41	40	Approx. 54 – 66

OK or NG

- OK >> GO TO 3.  
NG >> Repair the front air control branch line.

## 3.CHECK POWER SUPPLY AND GROUND CIRCUIT

Check the power supply and the ground circuit of the front air control. Refer to the following.

- Models with automatic air conditioner: [ATC-49, "Power Supply and Ground Circuit for Front Air Control"](#)
- Models with manual air conditioner: [MTC-48, "Power Supply and Ground Circuit for Front Air Control"](#)

OK or NG

- OK >> • Present error: Replace the front air control. Refer to the following.  
- Models with automatic air conditioner: [ATC-127, "Removal and Installation"](#)  
- Models with manual air conditioner: [MTC-113, "Removal and Installation"](#)  
• Past error: Error was detected in the front air control branch line.
- NG >> Repair the power supply and the ground circuit.

## Combination Meter Branch Line Circuit

INFOID:000000001719359

### INSPECTION PROCEDURE

## 1.CHECK CONNECTOR

1. Turn the ignition switch OFF.
2. Disconnect the battery cable from the negative terminal.
3. Check the terminals and connectors of the combination meter for damage, bend and loose connection (unit side and connector side).

OK or NG

- OK >> GO TO 2.  
NG >> Repair the terminal and connector.

## 2.CHECK HARNESS FOR OPEN CIRCUIT

1. Disconnect the connector of combination meter.
2. Check the resistance between the combination meter harness connector terminals.

Combination meter harness connector			Resistance (Ω)
Connector No.	Terminal No.		
M24	9	11	Approx. 54 – 66

OK or NG

- OK >> GO TO 3.  
NG >> Repair the combination meter branch line.

## 3.CHECK POWER SUPPLY AND GROUND CIRCUIT

Check the power supply and the ground circuit of the combination meter. Refer to [DI-17, "Power Supply and Ground Circuit Inspection"](#).

OK or NG

- OK >> • Present error: Replace the combination meter. Refer to [DI-22, "Combination Meter"](#).  
• Past error: Error was detected in the combination meter branch line.
- NG >> Repair the power supply and the ground circuit.

A  
B  
C  
D  
E  
F  
G  
H  
I  
J  
L  
M  
N  
O  
P

LAN

# TROUBLE DIAGNOSIS

< SERVICE INFORMATION >

[CAN]

## Steering Angle Sensor Branch Line Circuit

INFOID:000000001719360

### INSPECTION PROCEDURE

#### 1. CHECK CONNECTOR

1. Turn the ignition switch OFF.
2. Disconnect the battery cable from the negative terminal.
3. Check the terminals and connectors of the steering angle sensor for damage, bend and loose connection (unit side and connector side).

#### OK or NG

- OK >> GO TO 2.  
NG >> Repair the terminal and connector.

#### 2. CHECK HARNESS FOR OPEN CIRCUIT

1. Disconnect the connector of steering angle sensor.
2. Check the resistance between the steering angle sensor harness connector terminals.

Steering angle sensor harness connector			Resistance ( $\Omega$ )
Connector No.	Terminal No.		
M47	4	5	Approx. 54 – 66

#### OK or NG

- OK >> GO TO 3.  
NG >> Repair the steering angle sensor branch line.

#### 3. CHECK POWER SUPPLY AND GROUND CIRCUIT

Check the power supply and the ground circuit of the steering angle sensor. Refer to [BRC-54, "Schematic"](#).

#### OK or NG

- OK >> • Present error: Replace the steering angle sensor. Refer to [BRC-89, "Removal and Installation"](#).  
• Past error: Error was detected in the steering angle sensor branch line.  
NG >> Repair the power supply and the ground circuit.

## IPDM E/R Branch Line Circuit

INFOID:000000001719361

### INSPECTION PROCEDURE

#### 1. CHECK CONNECTOR

1. Turn the ignition switch OFF.
2. Disconnect the battery cable from the negative terminal.
3. Check the following terminals and connectors for damage, bend and loose connection (unit side and connector side).
  - IPDM E/R
  - Harness connector E25
  - Harness connector M90

#### OK or NG

- OK >> GO TO 2.  
NG >> Repair the terminal and connector.

#### 2. CHECK HARNESS FOR OPEN CIRCUIT

1. Disconnect the connector of IPDM E/R.
2. Check the resistance between the IPDM E/R harness connector terminals.

IPDM E/R harness connector			Resistance ( $\Omega$ )
Connector No.	Terminal No.		
E121	48	49	Approx. 108 – 132

#### OK or NG

- OK >> GO TO 3.



# TROUBLE DIAGNOSIS

[CAN]

## < SERVICE INFORMATION >

NG >> Repair the IPDM E/R branch line.

### 3.CHECK POWER SUPPLY AND GROUND CIRCUIT

Check the power supply and the ground circuit of the IPDM E/R. Refer to [PG-27, "IPDM E/R Power/Ground Circuit Inspection"](#).

#### OK or NG

OK >> • Present error: Replace the IPDM E/R. Refer to [PG-28, "Removal and Installation of IPDM E/R"](#).  
• Past error: Error was detected in the IPDM E/R branch line.

NG >> Repair the power supply and the ground circuit.

## CAN Communication Circuit

INFOID:000000001719362

### INSPECTION PROCEDURE

#### 1.CONNECTOR INSPECTION

1. Turn the ignition switch OFF
2. Disconnect the battery cable from the negative terminal.
3. Disconnect all the unit connectors on CAN communication system.
4. Check terminals and connectors for damage, bend and loose connection.

#### OK or NG

OK >> GO TO 2.

NG >> Repair the terminal and connector.

#### 2.CHECK HARNESS CONTINUITY (SHORT CIRCUIT)

Check the continuity between the data link connector terminals.

Data link connector		Continuity
Connector No.	Terminal No.	
M22	6	No
	14	

#### OK or NG

OK >> GO TO 3.

NG >> Check the harness and repair the root cause.

#### 3.CHECK HARNESS CONTINUITY (SHORT CIRCUIT)

Check the continuity between the data link connector and the ground.

Data link connector		Ground	Continuity
Connector No.	Terminal No.		
M22	6		No
	14		No

#### OK or NG

OK >> GO TO 4.

NG >> Check the harness and repair the root cause.

#### 4.CHECK ECM AND IPDM E/R TERMINATION CIRCUIT

1. Remove the ECM and the IPDM E/R.

# TROUBLE DIAGNOSIS

[CAN]

## < SERVICE INFORMATION >

2. Check the resistance between the ECM terminals.

ECM		Resistance ( $\Omega$ )
Terminal No.		
94	86	Approx. 108 – 132

3. Check the resistance between the IPDM E/R terminals.

IPDM E/R		Resistance ( $\Omega$ )
Terminal No.		
48	49	Approx. 108 – 132

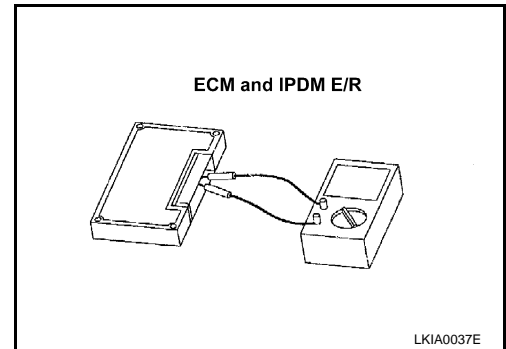

### OK or NG

OK >> GO TO 5.

NG >> Replace the ECM and/or the IPDM E/R.

## 5.CHECK SYMPTOM

Connect all the connectors. Check if the symptoms described in the "Symptom (Results from interview with customer)" are reproduced.

### Inspection result

Reproduced>>GO TO 6.

Non-reproduced>>Start the diagnosis again. Follow the trouble diagnosis procedure when past error is detected.

## 6.CHECK UNIT REPRODUCTION

Perform the reproduction test as per the following procedure for each unit.

1. Turn the ignition switch OFF
2. Disconnect the battery cable from the negative terminal.
3. Disconnect one of the unit connectors of CAN communication system.

### NOTE:

ECM and IPDM E/R have a termination circuit. Check other units first.

4. Connect the battery cable to the negative terminal. Check if the symptoms described in the "Symptom (Results from interview with customer)" are reproduced.

### NOTE:

Although unit-related error symptoms occur, do not confuse them with other symptoms.

### Inspection result

Reproduced>>Connect the connector. Check other units as per the above procedure.

Non-reproduced>>Replace the unit whose connector was disconnected.